

 **cofan**  
www.cofan.es



10<sup>a</sup> EDICIÓN

CATÁLOGO GENERAL / CATALOGUE GÉNÉRAL / GENERAL CATALOGUE / CATALOGO GENERALE / CATÁLOGO GERAL





4

MAQUINARIA / MACHINE / MACHINERY / MACCHINE / MAQUINARIA



52

HERRAMIENTA MANUAL / OUTILS À MAIN  
HAND TOOLS / ATTREZZATURA MANUALE / FERRAMENTA MANUAL



240

HERRAMIENTA NEUMÁTICA Y ACCESORIOS / OUTIL PNEUMATIQUE ET ACCESSOIRES  
PNEUMATIC TOOLS AND ACCESSORIES / SEGA PNEUMATICA / FERRAMENTA PNEUMÁTICA



298

ENGRASE Y AUTOMOCIÓN  
GRAISSAGE ET ACCESSOIRES AUTOMOBILES / LUBRICATION & AUTOMOTIVE PRODUCTS  
LUBRIFICAZIONE E PRODOTTI AUTOMOBILISTICI / LUBRIFICAÇÃO E AUTO

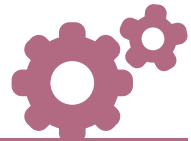

330

MATERIAL DE SEGURIDAD / MATÉRIEL DE SÉCURITÉ / SAFETY PRODUCTS  
MATERIALE PER ANTINFORTUNISTICA / MATERIAL DE SEGURANÇA



418

CERRAJERÍA / SERRURERIE / LOCKSMITHING / SERRALHARIA / SERRALHARIA



452

ABRASIVO, CORTE Y TALADRO / ABRASIF, COUPE ET FORÊT / ABRASIVE, CUT AND DRILL  
ABRASIVO, DA TAGLIO E FORATURA / ABRASIVO, CORTE E PERFURAÇÃO



520

FIJACIÓN / FIXATIONS / FIXING / COLLANTI / FIXAÇÃO



570

CABLE, CADENA & CORDELERÍA / CÂBLE, CHAINES & CORDES  
CABLES, CHAINS & CORDS / CAVI, CATENE & CORDE / CABO, CORRENTE & CORDAS



616

PINTURA, QUÍMICOS & ADHESIVOS / PEINTURES, CHIMIE & ADHÉSIFS  
PAINTING, CHEMICALS & ADHESIVES / VERNICI, CHIMICA & ADESIVI / PINTURA, QUIMÍCOS & ADESIVOS



680

MATERIAL ELÉCTRICO / MATERIEL ELECTRIQUE  
ELECTRICAL EQUIPMENT / MATERIALE ELETTRICO / MATELIAR ELÉCTRICO



732

SEÑALIZACIÓN / SIGNALÉTIQUE / SIGN POSTS / SEGNALETICA / SINALIZAÇÃO



784

AGRÍCOLA & JARDINERÍA / AGRICOLE & JARDINAGE / AGRICULTURAL & GARDENER  
AGRICOLTURA & GIARDINAGGIO / AGRICULTURA & JARDIM



842

AUTOSERVICIO / LIBRE SERVICE / SELF SERVICE / SELF SERVICE / AUTO-SERVIÇO





 **cofan**

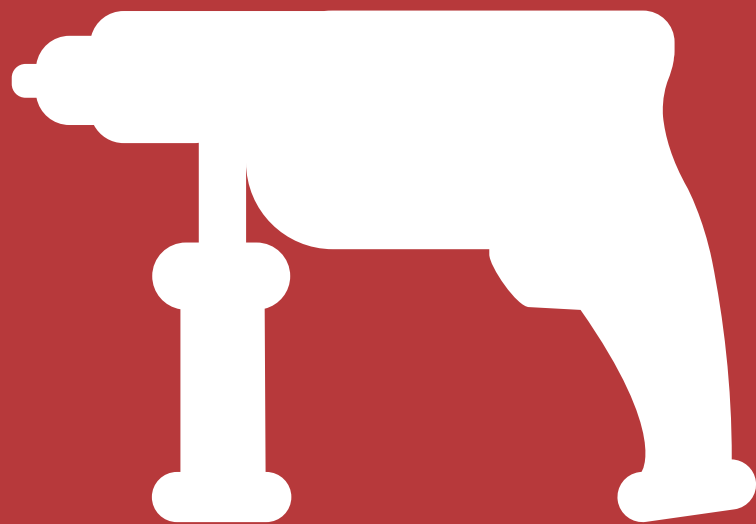



# ÍNDICE / INDEX / CONTENTS

## INDICE / ÍNDICE



**8**

HERRAMIENTA ELÉCTRICA A BATERÍA  
OUTIL ÉLECTRIQUE À BATTERIE  
BATTERY POWER TOOL  
UTENSILE ELETTRICO A BATTERIA  
FERRAMENTA ELÉTRICA COM BATERIA



**44**

HERRAMIENTA DE SOLDADURA / OUTIL DE SOUDURE  
WELDING TOOLS / STRUMENTI DI SALDATURA  
FERRAMENTA DE SOLDAR



**13**

HERRAMIENTA DE JARDINERÍA A BATERÍA  
OUTIL DE JARDINAGE À BATTERIE  
BATTERY GARDENING TOOL  
UTENSILE DA GIARDINO A BATTERIA  
FERRAMENTAS DE JARDINAGEM COM BATERIA

**i**

**50**

GLOSARIO / GLASSAIRE / GLOSSARY  
GLOSSARIO / GLOSSÁRIO



**16**

BATERÍAS RECARGABLES  
BATTERIES RECHARGEABLES  
RECHARGEABLE BATTERIES  
BATTERIE RICARICABILI  
BATERIAS RECARREGÁVEL



**18**

HERRAMIENTA ELÉCTRICA  
OUTIL ÉLECTRIQUE  
POWER TOOL  
ATTREZZATURA ELETTRICA  
FERRAMENTA ELÉTRICA



**29**

MAQUINARIA / MACHINE / MACHINERY  
MACCHINE / MAQUINARIA





TALADRO PERCUTOR A BATERÍA / PERCEUSE À BATTERIE / CORDLESS HAMMER DRILL  
 TRAPANO A PERCUSSIONE, A BATTERIA / BERBEQUIM DE PERCUSSÃO COM BATERIA

18 V



ES Taladro percutor y atornillador de 2 velocidades, con 16 posiciones de apriete, control variable de velocidad y selector de giro izquierda/derecha. Con luz de trabajo led y clip de metal para cinturón. Maletín con 11 piezas más cargador.

FR Perceuse à percussion et visseuse à 2 vitesses avec 16 positions de serrage, commande de vitesse variable et sélecteur de rotation gauche / droite. Dispose d'une lumière de travail et de clips en métal pour la ceinture. Malette avec accessoires et chargeur.

EN Hammer drill, 2 speed gear box, 16 torque applications, variable speed control and left/right drive selector. Working LED light and metal clip for belt. Case with accessories and charger.

IT Trapano a percussione e cacciavite a 2 velocità, con 16 posizioni di serraggio, controllo variabile della velocità e selettore di rotazione destra/sinistra. Dotato di luce di lavoro led e clip in metallo per cintura. Valigetta con accessori e caricabatterie.

PT Berbequim e aparafusador de 2 velocidades, com 16 posições de aperto, controle de velocidade variável e seletor de giro à esquerda/direita. Com luz de trabalho led e clipe de metal para o cinto. Mala com acessórios e carregador.

Ref	⌚	BATTERY	⚡	Ø MAX	Nm MAX	🔋	📦
5000 3202	0-350 rpm / 0-1300 rpm	Litio Li-ion	18V - 1,5Ah	13 mm	35 Nm	1 h	145,60

ATORNILLADOR PERCUTOR A BATERÍA / PERCEUSE À BATTERIE / CORDLESS IMPACT WRENCH  
 AVVITATORE A BATTERIA / APARAFUSADOR COM BATERIA

18 V



ES Atornillador percutor de impacto 1/4" con control variable de velocidad y selector de giro izquierda/derecha. Con 3 luces de trabajo led y clip de metal para cinturón. Maletín con accesorios más cargador (4pcs).

FR Visseuse à percussion, Impact 1/4 avec contrôle de vitesse variable et choix de rotation gauche / droite. Dispose de 3 lumières de travail à led et de clip en métal pour la ceinture. Malette avec accessoires et chargeur (4pcs).

EN 1/4" Cordless impact driver with variable speed control and left/right drive selector. Working LED light and metal clip for belt. Case with accessories and charger (4 pcs).

IT Cacciavite a impatto 1/4" con controllo regolabile della velocità e selettore di rotazione sinistra/destra. Dotato di 3 luci di lavoro led e clip in metallo per cintura. Valigetta con accessori e caricabatterie (4 pezzi).

PT Aparafusador de impacto 1/4" com controle de velocidade variável e seletor de giro à esquerda/ direita. Com 3 luzes de trabalho LED e clip de metal para o cinto. Mala com acessórios mais carregador (4pcs).

Ref	⌚	⚡	BATTERY	Ø MAX	Nm MAX	🔋	📦
5000 3203	0-2000 rpm / 0-3000 ipm	18V - 1,5Ah	Litio Li-ion 1/4" bits/puntas	150 Nm	1 h	166,40	



AMOLADORA A BATERÍA / MEULEUSE À BATTERIE / CORDLESS ANGLE GRINDER / SMERIGLIATRICE A BATTERIA / REBARBADORA COM BATERIA

18 V



ES Amoladora batería para discos de Ø115 mm con interruptor de seguridad, con mango (3 posiciones).

FR Meuleuse à batterie pour disques de Ø115mm avec interrupteur de sécurité, manche (3 positions).

EN Battery-powered angle grinder for Ø115mm discs with safety switch and handle (3 positions).

IT Smerigliatrice a batteria per dischi da Ø115mm con interruttore di sicurezza con impugnatura (3 posizioni).

PT Rebarbadora a bateria para discos de Ø115mm com interruptor de segurança, com punho (3 posições).

Ref	⌚	⚡	BATTERY	⊘	⚙️	🔋	📦
5000 3204	0-8000 rpm	18V - 2,0Ah	Litio Li-ion	115 mm	M-14	1 h	169,40

MULTIHERRAMIENTA A BATERÍA / OUTIL MULTIFONCTION À BATTERIE / CORDLESS MULTI-TOOL  
 UTENSILE MULTIUSO A BATTERIA / MULTIFERRAMENTA COM BATERIA

18 V



ES Multiherramienta a batería 18V con sistema cambio rápido de accesorios. Accesorios: triángulo lijado, sierra y raspador.

FR Outil multi-usage à batterie 18V avec système de changement rapide d'accessoires. Accessoires : triangle de ponçage, Scie et racloir.

EN 18V Battery-powered multitool with a system to change quickly of accessory. Accessories: triangle sanding pad, saw and scraper.

IT "Attrezzatura multiuso a batteria 18V con sistema di cambio rapido degli accessori. Accessori: levigatura, sega e raschietto."

PT Multiferramenta alimentada por bateria de 18V com sistema de troca rápida de acessórios. Acessórios: triângulo de lixamento, serra e raspador.

Ref	⌚	⚡	BATTERY	🔋	📦
5000 3205	5000-15000 rpm	18V - 1,5Ah	Litio Li-ion	1 h	145,60



Accesorios / Accessories

	Ref	🔪	📦	📦
1	5000 3205.01	Sierra para madera / Saw blade for wood	5	4,05
2	5000 3205.02	Raspador / Scraper	5	3,85
3	5000 3205.03	Almohadilla lijado / Sanding pad	5	4,99
4	5000 3205.04	Grano 80 / G 80	5	0,85
5	5000 3205.05	Grano 100 / G 100	5	0,85
6	5000 3205.06	Grano 120 / G 120	5	0,85





ASPIRADOR A BATERÍA / ASPIRATEUR À BATTERIE / CORDLESS VACUUM CLEANER / ASPIRATORE A BATTERIA / ASPIRADOR COM BATERIA

18 V



ES Aspiradora con batería 18v con prolongadores y accesorio giratorio.  
 FR Aspirateur à batterie 18v avec rallonges et accessoire rotatif.  
 EN 18V Battery-powered vacuum cleaner with extensions and swivel accessory.  
 IT Aspiratore a batteria 18V con estensione e accessorio rotante.  
 PT Aspirador a bateria de 18v com extensões e acessório giratório.

Ref			BATTERY	MAX. SUCTION		
5000 3207	600 ml	18V - 1,5Ah	Litio Li-ion	1.8 kpa	1 h	124,80



FILTRO PARA ASPIRADOR A BATERIA / FILTER FOR CORDLESS VACUUM CLEANER

Ref	
5000 3207.01	7,25

ATORNILLADOR A BATERÍA / PERCEUSE À BATTERIE / CORDLESS SCREWDRIVER / AVVITATORE A BATTERIA / APARAFUSADOR COM BATERIA

3,6 V



Incluye / Includ / Includes / Include / Includi:



ES Destornillador de batería de litio-ion de 3,6 voltios con potencia constante. Contiene Mini cortador de disco y adaptador angular como accesorios incluidos.  
 FR Tournevis batterie lithium-ion de 3.6 volts avec puissance constante. Accessoires inclus: contient Mini coupe à disque et adaptateur angulaire.  
 EN 3.6V Lithium-ion cordless screwdriver with constant power. It includes mini cutting disc and angle adapter.  
 IT Cacciavite a batteria agli ioni di litio da 3,6V con potenza costante. Include mini disco da taglio e adattatore angolare.  
 PT Chave de fenda de bateria de íon de lítio de 3,6 volts com potência constante. Contém mini disco de corte e adaptador de ângulo como acessórios incluídos.

Ref	rpm		BATTERY	Nm,MAX		
5000 3201	0-200 rpm	3.6V - 1,5Ah	Litio Li-ion	3 Nm	3 - 5 h	57,82



CARGADOR DE BATERÍA / CHARGER

Ref		
5000 3201.01	3.6V	11,70



ATORNILLADOR ELÉCTRICO MULTIPUNTAS / PERCEUSE ÉLECTRIQUE MULTIPONTES / MULTIBIT SCREWDRIVER  
AVVITATORE ELETTRICO MULTIPUNTA / APARAFUSADOR ELÉCTRICO MULTIPONTAS

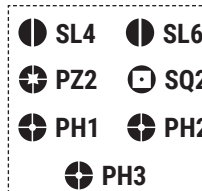

ES BATERÍA INTEGRADA: 4V Litio-Ion, 1,3 Ah (conserva la carga hasta 18 meses). TIEMPO DE CARGA: 90 minutos utilizando un cargador de pared USB 1A (cargador no incluido). RPM: 200. PAR DE APRIETE: 3.95-4.5 Nm. MOTOR: 380 W. INCLUYE: Atornillador Multipuntas 4V, cable de carga magnético USB, 7 puntas y manual de instrucciones.

FR BATTERIE INTÉGRÉE: 4V lithium- Ion, 1,3 Ah (charge jusqu'à 18 mois). TEMPS DE CHARGE: 90 minutes en utilisant un chargeur mural USB 1A (chargeur non inclus). RPM : 200. TORSION: 3.95-4.5 Nm. MOTEUR: 380 W. INCLUT: Perceuse Multipointes 4V, câble de charge magnétique USB, 7 pointes et manuel d'instructions.

EN INTEGRATED BATTERY: 4V Lithium-ion, 1,3 Ah (retains charge upto 18 months). CHARGE TIME: 90 minutes usng USB 1A Wall Charger (charger not included). RPM: 200. TORQUE: 3.95-4.5 Nm. MOTOR: 380W. INCLUDES: 4V Multibit Screwdriver, USB magnetic charge cable, 7 bits and instruction manual.

IT BATTERIA INTEGRATA: 4V Litio-Ion, 1,3 Ah (mantiene la carica fino a 18 mesi). TEMPO DI CARICA: 90 minuti utilizzando un caricatore da parete USB 1A (caricatore non incluso). RPM: 200. TORSIONE: 3,95-4,5 Nm. MOTORE: 380W. INCLUDE: Avvitatore Multipunta 4V, cavo di ricarica magnetico USB, 7 punte e manuale di utilizzo.

PT BATERIA INTEGRADA: 4V Litio-Ion, 1,3 Ah (mantém a carga até 18 meses). TEMPO DE CARGA: 90 minutos, utilizando um carregador de parede USB 1A (carregador não incluído). RPM: 200. TORSÃO: 3.95-4.5 Nm. MOTOR: 380 W. INCLUÍ: Aparafusador multipontas 4V, cabo de carregamento magnético USB, 7 pontas e manual de instruções.

Ref	rpm	⚡	BATTERY	Nm,MAX	🔋	📖
5000 1006	0-200 rpm	4.0V - 1,3Ah	Litio Li-ion	4,5 Nm	1,5 h	69,25



CABLE CARGADOR MAGNÉTICO / MAGNETIC CHARGER WIRE

Ref	⚡	📖
5000 1006.01	4.0V	10,00

FOCO LED PORTÁTIL A BATERÍA / PROJECTEUR LED PORTABLE A BATTERIE LI-ION / PORTABLE LED WORK LIGHT BATTERY-OPERATED LI-ION  
FARETTO LED PORTATILE A BATTERIA LI-ION / FOCO LED PORTÁTIL A BATERIA LI-ION

18 V



ES Foco proyector de trabajo led giratorio a batería 18v, estructura de aluminio 3 intensidades de luz. Interruptor con 4 funciones: 100% - 60% - 30% - Apagado.

FR Projecteur de travail led giratoire à batterie 18v, structure en aluminium 3 intensités de lumière plus interrupteur. Interrupteur avec 4 fonctions : 100% - 60% - 30% - Arrêt

EN Portable and swivel LED work light, aluminium structure and 3 types of light intensity with switch. Switch with 4 functions: 100% - 60% - 30% - Off.

IT "Proiettore da lavoro, led rotante, a batteria 18V. Struttura in alluminio, 3 differenti intensità della luce, con interruttore. Interruttore con 4 funzioni: 100% - 60% - 30% - Spento."

PT Foco projetor de trabalho led giratório alimentado a bateria 18v, estrutura de alumínio, 3 intensidades de luz mais interruptor. Interruptor com 4 funções: 100% - 60% - 30% - Desligado.

Ref	LED W	⚡	BATTERY	🌀	Lm	🔋	📖
5000 3206	20W	18V - 1,5Ah	Litio Li-ion	6000 °k	1800 Lm	1 h	141,44



PISTOLA IMPACTO 1/2" BATERIA 18V / CLÉ À CHOC 1/2" BATTERIE 18V / AIR IMPACT GUN 1/2" BATTERY 18V  
 CHIAVE DI IMPATTO 1/2" BATERIA 18V / PISTOLA DE IMPACTO 1/2" BATERIA 18V

18 V



SIN ESCOBILLAS / BRUSHLESS

ES	Torque Máx / Max. torque	400 N.M
EN	Escala Ajustable Electrónica / Electronic adjustable scale	100/150/200/300/400 N.M
	RPM	0 - 2:200 RPM
	Golpes por minuto / Hits per minute	0 - 3300 BPM
	Bocas Cuadradillo / Square socket	1/2"
	Batería / Battery	1,5 Ah

Ref	⚡	BATTERY	🔋	📦
5000 3310	18V - 1,5Ah	Litio Li-ion	1 h	115,20

ALTAVOZ BLUETOOTH 2X2,5W BATERIA / HAUT-PARLEUR BLUETOOTH 2X2, BATTERIE 5W / SPEAKER BLUETOOTH 1/2", BATTERY 5W  
 ALTOPARLANTE BLUETOOTH 2X2, 5W BATERIA / ALTAVOZ BLUETOOTH 2X2,5W BATERIA

18 V



5 BOTONES DE SILICONA / 5 SILICONE BUTTONS

ES	Alcance / Scope	10 m
EN	Voltaje / Voltage	18 V
	Potencia Salida / Output power	2/2,5 W
	Tamaño de Mini Jack / Mini-jack size	3,5 mm
	Puerto USB / USB port	Power Bank
	Batería / Battery	1,5 Ah

Ref	⚡	BATTERY	🔋	📦
5000 3311	18V - 1,5Ah	Litio Li-ion	1 h	49,75

ASPIRADOR DE CENIZAS BATERIA 18V / ASPIRATEUR À CENDRE BATTERIE 18V / ASH VACUUM CLEANER BATTERY 18V  
 ASPIRA CENERE BATERIA 18V / ASPIRADOR DE CINZAS BATERIA 18V

18 V



ES	Capacidad del tanque / Tank capacity	10 l
EN	Nivel de sonoridad / Sound level	≤ 72 dB
	Batería / Battery	2.0 Ah
	Vacuidad / Vacuity	8 Kpa
	Tiempo de funcionamiento / Working time	20 min

Ref	⚡	BATTERY	🔋	📦
5000 3312	18V - 2,0Ah	Litio Li-ion	1 h	65,40



SOPLADORA ELÉCTRICA A BATERÍA / SOUFFLEUSE ÉLECTRIQUE À BATTERIE / LI-ION CORDLESS LEAF BLOWER  
 SOFFIATORE ELETTRICO A BATTERIA / SOPRADOR ELÉTRICO A BATERIA

18 V



MOTOR 2 VELOCIDADES  
 2-SPEED GEARBOX

ES Soplador a batería Litio-ion 18v con agarre suave y ligero en peso.  
 FR Souffleur à batterie lithium- Ion 18v, manieement agréable et léger en poids.  
 EN 18V Lithium-ion leaf blower with soft grip and lightweight.  
 IT Soffiatore a batteria agli ioni di litio da 18V con impugnatura morbida e di peso leggero.  
 PT Soprador de bateria de iões de lítio 18V com aderência suave e leve quanto ao peso.

Ref	km/h	rpm	⚡	BATTERY	🕒	🔋	📦
5000 3304	150 km/h (speed 1) 210 km/h (speed 2)	12000 rpm	18V - 1,5Ah	Litio Li-ion	10 min	1 h	122,72

DESBROZADORA ELÉCTRICA A BATERÍA / DEBROUSAILLEUSE ÉLECTRIQUE A BATTERIE / LI-ION CORDLESS LAWN TRIMMER  
 DECESPUGLIATORE ELETTRICO A BATTERIA / ROÇADORA ELÉTRICA A BATERIA

18 V



TELESCÓPICO  
 TELESCOPIC

ES Desbrozadora a batería Litio-ion 18v ajustable a 10-12 cm de longitud y telescópica.  
 FR Débrousailleuse à batterie lithium- Ion 18v longueur réglable à 10-12 cm et télescopique.  
 EN 18V Lithium-ion telescopic lawn trimmer. It can be adjusted to 10-12 cm long.  
 IT Decespugliatore a batteria agli ioni di litio da 18V, regolabile a 10-12cm di lunghezza e telescopico.  
 PT Aparador a bateria de lítio-ion 18v ajustável para 10-12 cm de comprimento e telescópica.

Ref	🌀	∅	🔪	⚡	BATTERY	rpm	🕒	🔋	📦
5000 3302	230 mm	1,2 mm	300 mm	18V - 1,5Ah	Litio Li-ion	10000 rpm	45 min	1 h	136,86



Recambio / Sparte part

Ref	📦	📦
5000 3302.01	∅ 1,2 mm x 5 m	7,25





CORTACÉSPED DE MANO A BATERÍA / TONDEUSE À GAZON MANUELLE A BATTERIE / CORDLESS HANDHELD HEDGE TRIMMER  
 TAGLIASIEPI A MANO CON BATTERIA / CORTADOR DE RELVA DE MÃO A BATERIA

3,6 V



ES Cortasetos y cortacésped a batería con cambio rápido de sierra. Con doble función de corte de césped y recorte de setos.

FR Taille haie et tondeuse à gazon à batterie avec changement rapide de lame de coupe. Double fonction de coupe gazon et de taille haies.

EN Battery-powered hedge trimmer with wheels and a system to change quickly the saw. Double function: grass and hedge cutting.

IT Tagliasiepi e tosaerba con cambio rapido della sega. Con doppia funzione di taglio del prato e delle siepi.

PT Corta-sebes e cortador de relva a bateria com mudança rápida de serra. Com função dupla de cortar relva e sebes.

Ref	Blade	Wheel	Battery	BATTERY	Ø MAX	rpm	Runtime	Price
5000 3301	110 mm	70 mm	DC 3.6V - 1,5Ah	Litio Li-ion	≤ Ø 7,5 mm	1000 rpm	3 - 5 h	49,50

CARGADOR DE BATERIA / CHARGER

Ref	Battery	Price
5000 3301.01	3.6V	11,25

CORTASETOS ELÉCTRICO A BATERÍA / TAILLE-HAIE ÉLECTRIQUE À BATTERIE / LI-ION CORDLESS HEDGE TRIMMER  
 TAGLIASIEPI ELETTRICO A BATTERIA / CORTA-SEBES ELÉTRICO A BATERIA

18 V



ES Cortasetos a batería Litio-ion 18v con espada de 51 cm y accionamiento de seguridad. 2200 cortes por minuto.

FR Taille haies à batterie lithium- Ion 18v avec lame de 51 cm et dispositif de sécurité. 2200 coupes par minute.

EN 18V Lithium-ion hedge trimmer with 51 cm long blade and safety start. 2200 cuts per minute.

IT Tagliasiepi a batteria agli ioni di litio da 18V con lama da 51cm e sistema di sicurezza. 2200 tagli per minuto.

PT Corta-sebes de bateria de litio-ion de 18v com lâmina de 51 cm e acionamento de segurança. 2200 cortes por minuto.

Ref	Blade	Battery	BATTERY	rpm	Runtime	Runtime	Price
5000 3303	450 mm	18V - 1,5Ah	Litio Li-ion	1100 rpm	45 min	1 h	160,99

KIT CORTASETOS DE MANO EXTENSIÓN Y RUEDAS A BATERÍA / KIT TAILLE HAIE A MAIN EXTENSION ET ROUES A BATTERIE  
 CORDLESS HANDHELD HEDGE TRIMMER KIT WITH ADJUSTABLE HANDLE AND WHEELS / KIT TAGLIASIEPI A MANO ESTENSIONE E RUOTE A BATTERIA  
 KIT CORTA-SEBES DE MÃO EXTENSÍVEL

18 V



SAFETY  
KEY

ES Cortasetos y cortacésped a batería con ruedas, cambio rápido de sierra. Con doble función de corte de césped y recorte de setos.

FR Taille haies et tondeuse à gazon à batterie avec roues, changement rapide de lame. Double fonction de tondeuse à gazon et de taille haies.

EN Battery-powered hedge trimmer with wheels and a system to change quickly the saw. Double function: grass and hedge cutting.

IT Tagliasiepi e tosaerba a batteria con ruote, cambio rapido della lama. Con doppia funzione di taglio del prato e delle siepi.

PT Corta-sebes e cortador de relva a bateria com rodas e mudança rápida de serra. Com função dupla de cortar relva e sebes.

Ref	Blade	Wheel	Battery	BATTERY	rpm	Runtime	Runtime	Price
5000 3305	199 mm	92 mm	18V - 1,5Ah	Litio Li-ion	1200 rpm	40 min	1 h	162,24



CORTASETOS ELÉCTRICO DE LARGO ALCANCE A BATERÍA / TAILLE-HAIE ÉLECTRIQUE LONGUE PORTÉE A BATTERIE / CORDLESS POLE HEDGE TRIMMER  
TAGLIASIEPI TELESCOPICO A BATTERIA / CORTA-SEBES ELÉTRICO DE LONGO ALCANCE A BATERIA

18 V

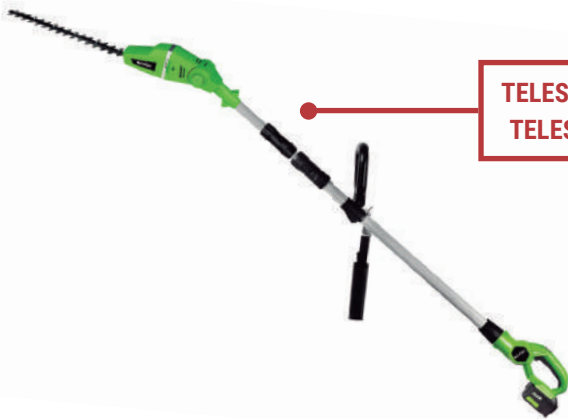

TELESCÓPICO  
TELESCOPIC

ES Cortasetos a batería telescópica de largo alcance con estructura de aluminio. Cabezal con 7 posiciones. 1400 cortes por minuto.

FR Taille haies à batterie, télescopique de longue portée avec structure en aluminium. Structure avec 7 positions. 1400 coupes par minute.

EN Battery-powered pole hedge trimmer, long reach and aluminium structure. 7 cutting positions. 1400 cuts per minute.

IT Tagliasiepi a batteria telescopica a lunga portata con struttura in alluminio. 7 posizioni di taglio. 1400 tagli per minuto.

PT Corta-sebes de bateria telescópica de longo alcance com estrutura de alumínio. Cabeça com 7 posições. 1400 cortes por minuto.

Ref	Blade	Head	Length	Voltage	BATTERY	rpm	Runtime	Weight
5000 3306	380 mm	16 mm	1830 - 2770 mm	18V - 1,5Ah	Litio Li-ion	1400 rpm	40 min	1 h 241,28

SIERRA DE CADENA ELÉCTRICA A BATERÍA / SCIE A CHAÎNE ÉLECTRIQUE À BATTERIE / CORDLESS CHAINSAW  
CATENA SEGA ELETTRICA A BATTERIA / ELETROSERRA A BATERIA

18 V

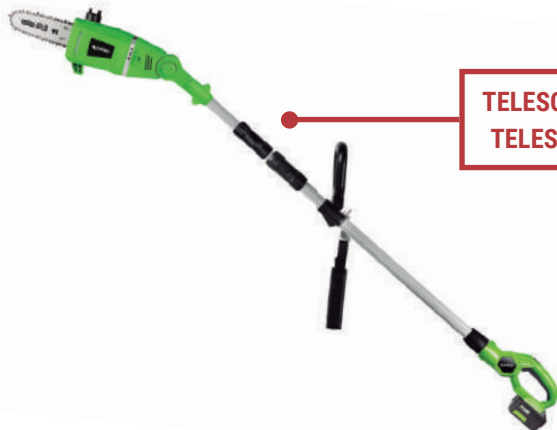

TELESCÓPICO  
TELESCOPIC

ES Podadora de cadena a batería telescópica de largo alcance con estructura de aluminio. Cabezal con 7 posiciones.

FR Taille haies à chaîne et à batterie, télescopique de longue portée avec structure en aluminium. Structure avec 7 positions.

EN Battery-powered telescopic chainsaw, long reach with aluminium structure. 7 cutting positions.

IT Potatrice a catena con batteria. Telescopica, a lunga portata, con struttura in alluminio. 7 posizioni di taglio.

PT Eletroserra de corrente telescópica de longo alcance movida a bateria com estrutura de alumínio. Cabeça com 7 posições.

Ref	Blade	Head	SPEED	Length	Voltage	BATTERY	Runtime	Weight
5000 3307	200 mm	16 mm	3,76 m/s	1830 - 2770 mm	18V - 1,5Ah	Litio Li-ion	40 min	1 h 249,60

CORTACÉSPED ELÉCTRICO CON RUEDAS / TONDEUSE À GAZON ÉLECTRIQUE AVEC ROUES / CORDLESS LAWN MOWER WITH WHEELS  
TAGLIASIEPI ELETTRICO CON RUOTE / CORTADOR DE RELVA ELÉTRICO COM RODAS

2 x 18 V = 36 V



ES Cortacésped a batería con 5 posiciones de corte, depósito de 40 litros y ancho de corte en 400 mm.

FR Tondeuse à gazon à batterie avec 5 positions de coupe, réservoir de 40 litres et largeur de coupe à 400 mm.

EN Battery-powered lawnmower with 5 cutting heights, 40 litre collect box and 400 mm cutting width.

IT Tosaerba a batteria con 5 posizioni di taglio, contenitore da 40 litri e angolo di taglio da 400 mm.

PT Cortador de relva a bateria com 5 posições de corte, depósito de 40 litros e largura de corte de 400 mm.

Ref	Capacity	Blade	Height	Voltage	BATTERY	rpm	Runtime	Weight
5000 3308	40 L	400 mm	25 - 65 mm	2 x 18V / 4,0Ah	Litio Li-ion	3200 rpm	40 min	3 h 478,40



BATERÍA RECARGABLE DE LITIO / BATTERIE RECHARGEABLE DE LITHIUM / RECHARGEABLE LITHIUM BATTERY  
BATTERIA RICARICABILE AL LITIO / BATERIA RECARREGÁVEL DE LÍTIO

**18 V**



**SYSTEM FOR-ALL**

ES Baterías de Litio de 1.500, 2.000 y 4.000 mAh para herramientas eléctricas a batería con sistema For-All.

FR Batteries de Lithium de 1.500, 2.000 et 4.000 mAh pour outils électriques à batterie avec système For-All.

EN Lithium batteries available in 1,500 - 2,000 and 4,000 mAh suitable for power tools with For-All system.

IT Batterie al Litio da 1.500, 2.000 e 4.000 mAh per attrezzatura elettrica a batteria, con sistema For-All.

PT Baterias de lítio de 1.500, 2.000 e 4.000 mAh para ferramentas elétricas alimentadas por bateria com sistema For-All.

**1.5 Ah**



Ref	MODEL	⚡	🔋
5000 3221	Litio Li-ion	18V - 1,5Ah	47,20

**2.0 Ah**

Ref	MODEL	⚡	🔋
5000 3222	Litio Li-ion	18V - 2,0Ah	53,20

**4.0 Ah**

Ref	MODEL	⚡	🔋
5000 3223	Litio Li-ion	18V - 4,0Ah	88,00

Batería / Battery	Cargador / Charger		
	5000 3212	5000 3211	5000 3210.01
 <b>5000 3221</b> <b>1.5 Ah</b>	20 min	25 min	30 min
 <b>5000 3222</b> <b>2.0 Ah</b>	30 min	35 min	45 min
 <b>5000 3223</b> <b>4.0 Ah</b>	55 min	60 min	90 min



CARGADOR BATERIAS / CHARGEUR DE BATTERIE / BATTERY CHARGER / CARICABATTERIE / CARREGADOR BATERIAS

18 V

SYSTEM  
FOR-ALL



Batería - Carga  
Battery - Charge

1,5 Ah - 20 min  
2,0 Ah - 30 min  
4,0 Ah - 55 min



Ref	⚡	📦
5000 3212	4,0 A	39,95

ES **Carga ultrarrápida.** Dispositivo ultra eficaz, ya que cuenta con los mejores componentes electrónicos de baja disipación de energía que liberan poco calor. Protección múltiple inteligente, con un sistema de software y hardware integrado. Ofrece una protección contra la sobrecarga, el sobrecalentamiento y la sobrecarga de corriente que pudieran provocarse por algún problema de hardware. Si surgiera algún problema, dejaría de cargar y mostraría las condiciones de falla a través de diferentes indicadores LED. Ecuilización inteligente, mientras se cargue, entrará en contacto con la batería digitalmente, de forma que cada celda de la batería esté completamente controlada, lo que ayuda a alargar la vida de la batería.

FR **Charge ultrarapide.** Appareil ultra-efficace, car il possède les meilleurs composants électroniques à faible dissipation d'énergie qui dégagent peu de chaleur. Protection multiple intelligente, avec un système logiciel et matériel intégré. Il offre une protection contre la surcharge, la surchauffe et la surcharge de courant qui pourraient être causées par un problème matériel. Si un problème survient, la charge s'arrête et les conditions de défaut sont affichées via différents indicateurs LED. L'égalisation intelligente, pendant la charge, entrera en contact avec la batterie numériquement, de sorte que chaque cellule de la batterie est entièrement contrôlée, ce qui contribue à prolonger la durée de vie de la batterie.

EN **Ultrafast charging.** Ultra high efficiency, uses the best low power dissipation electronic component which release little heat. Intelligent multi protection, is an intelligent charger with software and hardware. The protection covers overcharging, overcurrent and overheating, caused by hardware problems. It will stop charging and shows fault conditions through different LED light if an issue occurs. Intelligent voltage Equalization, will communicate with the battery digitally when charging, and each battery cell is fully controlled. This helps to prolong the battery pack life.

IT **Ricarica rapida.** Dispositivo ad alto rendimento che utilizza il miglior componente elettronico di dissipazione di bassa potenza già che rilasciano poco calore. Multi-protezione intelligente basata su caricatore intelligente con un sistema software e hardware incorporato. Offre una protezione contro il sovraccarico, il surriscaldamento e la sovrintensità di corrente provocati da qualche problema di hardware. Se si verifica un problema, il dispositivo interromperà la ricarica e mostrerà i condizioni di guasto attraverso degli diversi indicatori LED. Equalizzazione di tensione intelligente, si comunicherà con la batteria digitalmente durante la ricarica in modo che ogni cella della batteria sia interamente controllata, aiutando a prolungare la durata della batteria.

PT **Carga ultrarrápida.** Dispositivo ultra eficaz, conta com uns componentes eletrónicos de baixa dissipação de energia que libertam pouco calor. Proteção múltiple inteligente, trata-se de um carregador inteligente com um sistema de software e hardware integrado. Oferece uma proteção contra a sobrecarga, sobreaquecimento e sobrecarga de corrente que possa provocar algum problema de hardware. Se surgir algum problema, deixará de carregar e mostrará as falhas através de diferentes indicadores LED. Equalização inteligente - Enquanto a carrega, entra em contacto com a bateria digitalmente, de forma a que cada célula da bateria esteja completamente controlada, o que a ajuda a perlongar a vida útil da bateria.



Batería - Carga  
Battery - Charge

1,5 Ah - 25 min  
2,0 Ah - 35 min  
4,0 Ah - 60 min



Ref	⚡	📦
5000 3211	2 x 3,5 A	51,80

CARGADOR BATERIAS / CHARGEUR DE BATTERIE / BATTERY CHARGER / CARICABATTERIE / CARREGADOR BATERIAS

Batería - Carga  
Battery - Charge

1,5 Ah - 30 min  
2,0 Ah - 45 min  
4,0 Ah - 90 min



Ref	⚡	📦
5000 3210.01	2,4 A	26,10





SIERRA CIRCULAR CON LASER EXTERNO / SCIE CIRCULAIRE AVEC LASER EXTÉRIEUR / CIRCULAR SAW WITH EXTERNAL LASER  
 SERRA CIRCOLARE CON LASER ESTERNO / SERRA CIRCULAR COM LASER EXTERNO



5800 RPM  
1500 W

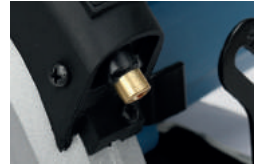

LÁSER



ES Sierra Circular 1.500W - 64mm profundidad - Ø 185mm Potencia de salida 1.500W, 5.800 rpm, diámetro de la hoja 185mm, diámetro interior 20mm, capacidad de biselado 0-45°, máx. profundidad de corte a 90°/45° 64/42mm, peso 5Kg. EQUIPO: Hoja de sierra Ø185mm con 24 dientes, guía paralela, llave para la hoja, laser externo a pilas (no es necesaria la conexión eléctrica).

FR Scie circulaire 1500W - Profondeur 64mm - Ø 185mm. Puissance de sortie 1500W, 5.800 tours / minute, diamètre de la lame 185mm, diamètre interne 20 mm, capacité de chanfreinage 0-45°, max. profondeur de coupe à 90° / 45° 64 / 42mm, poids 5 kg. ÉQUIPE: Lame de scie Ø185mm à 24 dents, guide parallèle, clé à lame, laser externe à piles (aucune connexion électrique requise).

EN Circular saw 1500W - depth 64 mm - Ø 185mm. Output power 1,500W, 5,800 rpm, blade diameter 185mm, internal diameter 20mm, chamfering capacity 0-45°, max. cutting depth to 90°/45° 64/42mm, weight 5kgs. EQUIPMENT: saw blade Ø185mm with 24 teeth, a parallel control, a key blade, a external battery laser (power connection is not required).

IT Serra circolare 1500W - profondità 64mm - Ø 185mm. Potenza in uscita 1.500W, 5.800 rpm, diametro di lama 185mm, diametro interno 20mm, capacità di smussatura 0-45°, profondità di taglio 90°/45° 64/42mm, peso 5kg. EQUIPAGGIAMENTO: lama di serra Ø185mm con 24 denti, esercizio parallelo, chiave dalla lama, batteria esterna laser (il collegamento di potenza non è richiesto).

PT Serra Circular 1.500W - 64mm profundidade - Ø 185mm Potencia de saída 1.500W, 5.800 rpm, diâmetro da folha 185mm, diâmetro interior 20mm, capacidade de corte 0-45°, máx. profundidade de corte a 90°/45° 64/42mm, peso 5Kg. EQUIPAMENTO: Lamina de serra Ø185mm con 24 dentes, guia paralela, chave para a lamina, laser externo a pilhas (nao é necessário a conexao eléctrica).

ES Para corte largo y recto en madera y materiales no féreos.

FR Pour une coupe longue et droite du bois et des matériaux non ferreux.

EN It is intended for long and straight cuts of wood or other non ferrous materials.

IT Può essere utilizzata per tagli lunghi e diritta, e anche altri materiali non ferrosi.

PT Para cortes longos e retos em madeira e materiais não ferrosos.

ES Diseño ligero y compacto, fácil manejo.

FR Conception légère et compacte, manipulation facile.

EN Lightweight and compact design, easy to handle.

IT Design leggero e compatto, facile da maneggiare.

PT Design leve e compacto, fácil manuseio.

Ref			W				
5000 1210	5800 rpm	220 - 240 V	1500 W	64 mm	48 mm	185 mm	146,40



Recambio / Spare parts

DISCO CORTE PARA MADERA / DISQUE DE COUPE POUR BOIS  
 CIRCULAR SAW BLADE FOR CUTTING WOOD / DISCO TAGLIO PER LEGNO  
 DISCO CORTE PARA MADEIRA

Ref			
1006 0185	24 dientes	185 x 20 x 2,4 mm	10,50



MINI SIERRA CIRCULAR ELECTRICA 705W Ø115MM / MINI SCIE CIRCULAIRE ELECTRIQUE 705W Ø115MM / MINI ELECTRIC CIRCULAR SAW 705W Ø115MM  
MINI SEGA CIRCOLARE ELETTRICA 705W Ø115MM / MINI SERRA CIRCULAR ELÉTRICA 705W Ø115MM



705 W



ES	Tensión nominal / Rated voltage	220-240 V
EN	Frecuencia / Frequency	50/60 Hz
	Potencia entrada / Input power	705 W (5.8 A)
	Velocidad / Speed	3.500 RPM
	Ø Disco / Ø Blade	115 mm
	Profundidad máxima de corte 90° / Maximum cut depth at 90°	42,8 mm
	Profundidad máxima de corte 45° / Minimum cut depth at 45°	28 mm
	Disco de corte / Blade disc	INCLUIDO / INCLUDED

ES Adecuado para cortar maderas. Peso ligero en comparación con la sierra circular estándar. Extracción eficiente de polvo. Caja de engranajes rígida de aluminio. Protector superior e inferior de aluminio fundido a presión. Fácil para la operación con una sola mano.

FR Convient pour couper du bois. Léger par rapport à la scie circulaire standard. Extraction efficace de la poussière. Boîte de vitesses en aluminium rigide. Protection supérieure et inférieure en aluminium fondu sous pression. Facile à utiliser d'une seule main.

EN It's suitable for cutting wood. It weights less than the standard circular saw. Effective dust extraction. Rigid aluminium gearbox. Upper and lower protector made of die-cast aluminium. It makes easier to handle it with only one hand.

IT Adatto per tagliare il legno. Pesa meno della sega circolare standard. Estrazione della polvere efficace. Scatola di ingranaggi in alluminio rigido. Protezione per la zona superiore e inferiore della lama. Semplifica la gestione con una sola mano.

PT Adequado para corte de madeiras. Leve em comparação com a serra circular estándar. Extração eficiente do pó. Caixa de engrenagens de alumínio rígido. Protetor superior e inferior em alumínio fundido. Fácil de operar só com uma mão.

Ref	Max. P	
5000 1231	705 W	114,75



SIERRA DE CALAR ELECTRÓNICA / SCIE SAUTEUSE ELECTRONIQUE / ELECTRONIC JIG SAW / SEGNETTO ALTERNATIVO / SIERRA TICO TICO



0 - 45°  
 800 W  
 0-3000 RPM

LÁSER



EXTRACCIÓN SERRÍN  
 SAWDUST EXTRACTION

SOPLADOR ZONA CORTE  
 CUTTING AREA DUST BLOWER

ES Realiza cortes en madera, metal, porcelana, plástico o goma espuma.  
 FR Pour faire des coupes dans le bois, le métal, la porcelaine, le plastique ou le caoutchouc mousse.  
 EN It performs cuts on wood, metal, porcelain, plastic or foam rubber.  
 IT Può effettuare tagli su materiali legnosi, metallico, plastici o gommapiuma.  
 PT Faça cortes em madeira, metal, porcelana, plástico ou borracha de espuma.

ES Sierra de Calar 800W Electrónica con sistema patentado de cambio automático sin llave de hojas con vástago en T, mecanismo anti-vibración, acción pendular de 4 posiciones, base ajustable sin herramientas, arranque suave, rodillo de soporte de la hoja afilado en forma de V, soplador de la zona de corte, 0-3.100 cpm, longitud de carrera 26mm, capacidad de biselado 45°, capacidad máx. de corte 100mm, peso 2,7Kg. EQUIPO: Cubierta antiarañazos de la base, sistema antiastillas de la base, adaptador para extracción del serrín, selector de velocidad de corte, guía de corte laser externo con interruptor de encendido.

FR Scie sauteuse 800W Electronique avec système breveté de changement automatique sans clé de lame, tige en T, mécanisme anti-vibration, action pendulaire à 4 positions, base réglable sans outils, démarrage en douceur, rouleau de support de la lame tranchant en forme de V, ventilateur de la zone de coupe, 0-3 100 cpm, longueur de course 26 mm, capacité de chanfreinage 45°, capacité max. de coupe 100mm, poids 2,7Kg. EQUIPEMENT: couvercle anti-rayures de la base, système anti-éclats de la base, adaptateur pour enlever la sciure de bois, sélecteur de vitesse de coupe, guide de coupe au laser externe avec interrupteur d'allumage.

EN 800W electric jig saw with a patented automatic changer system without a Blade Wrench (T-shank blade), anti-vibration mechanism, tilting action with 4 positions, adjustable base with no tools, soft starter, V-shaped blade support sharp roller, dust blower in the cutting area, cpm 0-3.100, stroke length 26mm, chamfering capacity 45°, max. cutting capacity 100mm, weight 2.7kg. EQUIPMENT: sole plate, anti-splinter system in the base, sawdust extraction adapter, cutting speed selector, external laser cutting guide with power switch.

IT Seghetto alternativo 800W elettrica con un sistema brevettato di un cambiatore automatico senza chiave dalla lama T, meccanismo anti-vibrazione, azione basculante di 4 posizioni, piedino regolabile senza strumenti, avviatore statico, rullo affilato per supporto lama a forma di V, soffiatore per la polvere nella zona di taglio, cpm 0-3.100, lunghezza di corsa 26mm, capacità della smussatura 45°, max. capacità di taglio 100mm, peso 2,7kg. EQUIPAGGIAMENTO: rivestimento del piedino, sistema anti-scheggia nella base, adattatore per la estrazione della segatura, selettore di velocità di taglio, guida di taglio laser esterno con un interruttore principale.

PT Serra de recortes 800W Electrónica com sistema patentado de mudança automática sem chave de laminas com vástago em T, mecanismo anti-vibração, acção pendular de 4 posicoes, base ajustável sem ferramentas, arranque suave, rolo de suporte da lamina afiada em forma de V, soprador da zona de corte, 0-3.100 cpm, longitude de corte 26mm, capacidade de corte angular 45°, capacidade máx. de corte 100mm, peso 2,7Kg. EQUIPAMENTO: Proteção antiarranços da base, Proteção antiestática da base, adaptador para extração do serrin, selector de velocidade de corte, guia de corte laser externo com interruptor de acceso.

CALADORA HOJA TIPO "T"  
 JIG SAW T-SHANK BLADE



PROTECTOR ABATIBLE  
 FOLDING PROTECTOR

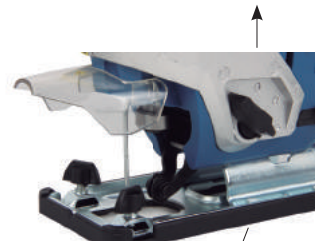

CUBIERTA ANTIARAÑAZOS  
 SOLE PLATE

CAMBIO RÁPIDO DE SIERRA  
 QUICK-CHANGE SAW

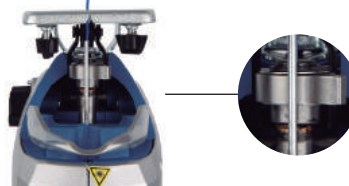

SELECTOR VELOCIDAD  
 SPEED SELECTOR



Ref	⚡	W	rpm	∠	STEEL	WOOD	🔧
5000 1225	220 - 240 V	800 W	3000 rpm	0 - 45°	10 mm	100 mm	92,50



PISTOLA DE AIRE CALIENTE CON PANTALLA DIGITAL LCD 2000W / PISTOLET AIR CHAUD LCD DIGITAL ECRAN LCD 2000W  
HEAT GUN WITH A DIGITAL LCD DISPLAY 2000W / PISTOLA AD ARIA CALDA CON DISPLAY LCD 2000W  
PISTOLA DE AR QUENTE LCD DIGITAL DISPLAY 2000W



2.000 W



**Contenido Kit / The kit contains:**

- Boquilla reflectora / Reflector Nozzle - 1 pc
- Boquilla protectora de vidrio / Glass protection nozzle - 1 pc
- Boquilla de superficie de cola de pez / Wide-slot nozzle - 1 pc
- Boquilla de concentración / Reduction nozzle - 1 pc
- Raspador / Scraper - 1 pc

ES	Tensión nominal / Rated voltage	220-240 V
EN	Frecuencia / Frequency	50/60 Hz
	Potencia entrada / Input power	2.000 W (16 A)
	Tiempo total de uso aprox. / Total working time (approx.)	≥ 650 h
	Temperatura / Temperature	I: 50°C II: 50-650°C
	Flujo de aire / Airflow	250-500 l x min

ES Pantalla digital LCD. Temperatura y flujo de aire ajustables, control de calor constante, protección contra sobrecalentamiento, programa preestablecido de datos de uso frecuente para un inicio rápido. Especificaciones de vida: ≥ 650 h.

Écran numérique LCD. Température et flux d'air réglables, contrôle de chaleur constante, protection contre la surchauffe, programme préétabli de données d'utilisation fréquentes pour un démarrage rapide. Caractéristiques de vie : ≥ 650 h.

LCD digital display. Adjustable temperature and airflow, continuously heat control, overheating protection, pre-set program with the frequently usage data for a quick start. Lifespan specifications: ≥ 650 h.

Display LCD digitale. Temperatura e flusso d'aria regolabili, con controllo costante del calore, protezione contro il surriscaldamento, programma preimpostato con i dati di utilizzo frequente per un avvio rapido. Durata dell'apparecchio: ≥ 650 h.

Ecrã digital LCD. Temperatura e fluxo de ar ajustáveis, controle de calor constante, proteção contra superaquecimento, programa predefinido de dados usados com frequência para início rápido. Especificações de vida: ≥ 650 h.

Ref	Max. P	
5000 1234	2000 W	92,25





AMOLADORA VELOCIDAD VARIABLE / MEULEUSE ANGULAIRE VITESSE VARIABLE / ANGLE GRINDER VARIABLE SPEED  
SMERIGLIATRICE ANGOLARE VELOCITÀ VARIABILE / REBARBADORA VELOCIDADE VARIÁVEL



900 W  
Ø 115-125 mm



ES Amoladora 115/125mm, 900W con interruptor hombre-muerto, empuñadura lateral antivibración, escobillas de desconexión automática, tuerca anti bloqueo, botón de bloqueo del eje. 3.000 - 12.000 rpm, máx. diámetro de disco max 125mm, rosca M14, peso 1,95Kg. EQUIPO: Guarda protectora 125mm, tuerca interna y externa, llave, empuñadura lateral antivibración multiposición, arranque progresivo y selector o variador de velocidad, sistema cambio rápido del disco.

FR Meuleuse 115 / 125mm, 900W avec commutateur homme mort, poignée latérale anti-vibration, brosses déconnexion automatique, écrou antiblocage, bouton de blocage de l'essieu. 3 000 - 12 000 tr / min, max. Diamètre maxi du disque 125 mm, filetage M14, poids 1,95 kg. ÉQUIPEMENT: guide de protection de 125 mm, écrou interne et externe, clé, poignée latérale anti vibration multiposition, démarrage progressif et sélecteur ou variateur de vitesse, système de changement rapide du disque.

EN 900W angle grinder 115/125mm with a dead-man switch, anti-vibration side handle, carbon brushes with automatic shut off, anti-lock screw, spindle lock button 3,000 -12,000 rpm, max. wheel diameter 125mm, thread M14, weight 1,95kg. EQUIPMENT: Protective guard 125mm, internal and external screw, wrench, multi-position & anti-vibration side handle, progressive start and variable speed selector or shifter, quick-change system wheel.

IT Smerigliatrice angolare 115/125mm, 900W con interruttore uomo morto, impugnatura laterale antivibrante, spazzole di carbone con spegnimento automatico, vite anti-bloccaggio, tasto di blocco del mandrino 3.000-12.000 rpm, diametro max. delle ruote 125mm, filettatura M14, peso 1,95kg. EQUIPAGGIAMENTO: scudo protettivo 125mm, vite interna ed esterna, chiave, impugnatura laterale antivibrante e multiposizione, inizio progressivo e selettore di velocità variabile, ruota del sistema a cambio rapido.

PT Rebarbadora 115/125mm, 900W com interruptor homem-morto, suporte lateral antivibração, escovas de desconexão automática, porca anti bloqueio, botao de bloqueio do eixo. 3.000 - 12.000 rpm, máx. diâmetro de disco max 125mm, rosca M14, peso 1,95Kg. EQUIPAMENTO: Guarda protectora 125mm, porca interna e externa, chave, suporte lateral antivibração multiposição, arranque progressivo e selector ou variador de velocidade, sistema de mudança rápido do disco.

ES Apto para cortar hormigón o ladrillo, repasar soldaduras de hierro y adecuado para el corte de azulejos.

FR Convient à la coupe du béton ou de la brique, soudures en fer et convient à la coupe des carreaux.

EN It is suitable for cutting concrete and brick, weld dressing on iron, and is also suited to cut tiles.

IT Adatta per il taglio di calcestruzzo o mattone, la pulizia di saldature in ferro, inoltre, è adatta per il taglio di piastrelle.

PT Adequado para cortar cimento ou tijolo, limpar soldas de ferro e adequado para cortar azuleijos.

Ref							
5000 1215	3000 - 12000 rpm	220 - 240 V	900 W	1,95 kg	M-14	115 - 125 mm	91,50



AMOLADORA ANGULAR 2400W / MEULEUSE ANGULAIRE 2400W / 2400W ANGLE GRINDER  
SMERIGLIATRICE ANGOLARE 2400W / REBARBADORA 2400W



2400 W  
Ø 230 mm



**ARRANQUE PROGRESIVO**  
PROGRESSIVE START



**EMPUÑADURA ANTI-VIBRACIÓN**  
ANTI-VIBRATION SIDE HANDLE



**INTERRUPTOR HOMBRE-MUERTO**  
DEAD-MAN SWITCH

ES Amoladora 230mm 2.400W, con interruptor hombre-muerto, empuñadura lateral antivibración, escobillas de desconexión automática, tuerca anti bloqueo, botón de bloqueo del eje. 6.500 rpm, máx. diámetro de disco 230mm, rosca M14, peso 5,60Kg. EQUIPO: Guarda protectora 230mm, tuerca interna y externa, llave, empuñadura lateral antivibración multiposición, Arranque progresivo. Motor potente, sistema cambio rápido del disco.

FR Meuleuse 230mm 2400W, avec interrupteur homme mort, poignée latérale anti-vibration, brosses de déconnexion automatique, écrou antiblocage, bouton de blocage de l'essieu 6 500 tr / min, max. diamètre du disque 230mm, filetage M14, poids 5,60 kg. ÉQUIPEMENT: Garde de protection 230mm, écrou interne et externe, clé, poignée latérale anti-vibration multiposition, Début progressif. Moteur puissant, système de changement de disque rapide.

EN 2,400W angle grinder 230mm with dead-man switch, anti-vibration side handle, carbon brushes with automatic shut off, anti-lock screw, spindle lock button 6,500rpm, max. wheel diameter 230mm, thread M14, weight 5.60kg. EQUIPMENT: Protective guard 230mm, internal and external screw, wrench, multi-position & anti-vibration side handle, progressive start. Powerful motor, quick-change wheel system.

IT Smerigliatrice angolare 230mm 2.400W, con interruttore uomo morto, impugnatura laterale antivibrante, spazzole di carbone con spegnimento automatico, vite anti-bloccaggio, tasto di blocco del mandrino 6.500 rpm, diametro max. delle ruote 230mm, filettatura M15, peso 5,60kg. EQUIPAGGIAMENTO: scudo protettivo 230mm, vite interna ed esterna, chiave, impugnatura laterale antivibrante e multiposizione, inizio progressivo. Motore potente, cambio rapido del sistema a ruota.

PT Rebarbadora 230mm 2.400W, com interruptor ponto-morto, suporte lateral antivibração, escovas de desconexão automática, porca anti bloqueio, botao de bloqueio do eixo. 6.500 rpm, máx. diâmetro de disco 230mm, rosca M14, peso 5,60Kg. EQUIPAMENTO: Proteção do disco 230mm, porca interna e externa, chave, suporte lateral antivibração multiposição, Arranque progressivo. Motor potente, sistema de mudança rápida do disco.

Ref							
5000 1230	6500 rpm	220 - 240 V	2400 W	5,6 kg	M-14	230 mm	185,90



TALADRO DE IMPACTO 600W / PERCEUSE À IMPACT 600 W / HAMMER DRILL 600W / TRAPANO A PERCUSSIONE 600W / APARAFUSADOR IMPACTO 600W



600 W  
Ø 13 mm



**Contenido Kit / The kit contains:**

Llave portabrocas / Drill chuck key - 1 pc

Mango auxiliar / Secondary side handle - 1 pc

Medidor de profundidad / Depth gauge - 1 pc

ES	Tensión nominal / Rated voltage	230 V
EN	Frecuencia / Frequency	50/60 Hz
	Potencia de entrada / Input power	600 W (4,6 A)
	Velocidad sin carga / No load speed	0-2.800 RPM
	Tamaño del mandril / Drill chuck size	Ø broca 13 mm
	Capacidad máxima de perforación / Maximum drilling capacity	Acero: 10 mm, madera: 20 mm, hormigón: 13 mm Steel: 10mm, wood: 20mm, concrete: 13mm

ES Interruptor de bloqueo con velocidad variable. Impacta y perfora. Mango de agarre suave.

FR Interrupteur de verrouillage à vitesse variable. Impact et forage. Poignée à prise souple.

EN Variable speed locking switch. Drilling and impact drilling. Soft grip handle.

IT Interruttore a velocità variabile con blocco. Fare della perforazione e trapanatura. Impugnatura con presa morbida.

PT Interupor de bloqueio com velocidade variável. Impacto e broca. Pega de agarre suave.

Ref	Max. P	
5000 1235	600 W	48,15



TALADRO IMPACTO 900W / PERCEUSE D'IMPACT MANDRIN 900W / IMPACT DRILL DRILL CHUCK 900W  
TRAPANO A PERCUSSIONE MANDRINO 900W / BERBEQUIM IMPACTO PORTABROCAS 900W



900 W  
Ø 13 mm

PORTABROCAS AUTOMÁTICO  
DRILL CHUCK



MÁX. 10 mm



MÁX. 25 mm



MÁX. 13 mm



900 W



13mm



ES Taladro percutor 910W Potencia de salida, 0-2800 rpm, 8.6Nm de par, portabrocas sin llave (Automático) 1-13mm, rosca 1/2 X 20 U.N.F., peso 2,70 Kg. 0-44800 ipm Empuñadura lateral multiposición, selector de velocidad en gatillo, portabrocas sin llave.

FR Perceuse à percussion 910W Puissance de sortie, 0-2800 tr / min, couple de 8,6 Nm, mandrin sans clé (automatique) 1-13mm, filetage 1/2 X 20 U.N.F., poids 2,70 Kg. 0-44800 ipm Poignée latérale multiposition, sélecteur de vitesse de déclenchement, mandrin sans clé.

EN 910W hammer drill. Output power. 0-2,800rpm, 8.6Nm of torque, keyless chuck (automatic) 1-13mm, thread 1/2 X 20 U.N.F., weight 2.70kg, 0-44800ipm. multi-position & anti-vibration side handle, speed selector in trigger, keyless drill chuck.

IT Trapano a percussione 910W. Potenza in uscita. 0-2800 rpm, 8,6Nm di coppia, mandrino autoserrante (automatico) 1-13mm, filettatura 1/2 X 20 U.N.F., peso 2,70kg, 0-44800 ipm., impugnatura laterale antivibrante e multiposizione, selettore da velocità in grilletto, mandrino autoserrante.

PT Berbequim percutor 910W Potencia de saída, 0-2800 rpm, 8.6Nm de par, portabrocas sem chave (Automático) 1-13mm, rosca 1/2 X 20 U.N.F., peso 2,70 Kg. 0-44800 rpm suporte lateral multiposição, selector de velocidade no gatilho, portabrocas sem chave.

Ref	⌚	⚡	W	🔩	Ø	📦
5000 1220	0 - 2800 rpm	220 - 240 V	910 W	0 - 44800 ipm	13 mm	85,90





TALADRO MARTILLO PERFORADOR SDS-PLUS / PERCEUSE À PERCUSSION SDS-PLUS / ROTARY HAMMER SDS-PLUS  
TRAPANO BATTENTE SDS-PLUS / MARTELO PERFORADOR SDS-PLUS



1050 W  
0-1100 RPM

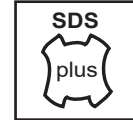
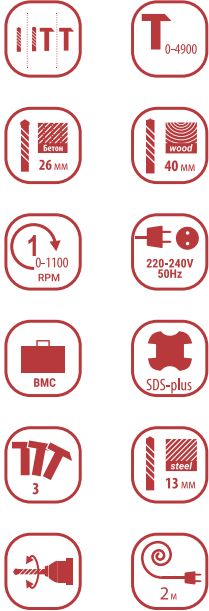

Capacidad / Capacity

Ø metal/steel: 13 mm  
Ø madera/wood: 40 mm  
Ø mampostería/masonry: 26 mm



ES Martillo Ligero Combinado 1050W 3 Modos SDS-Plus con cambio rápido de portabrocas 32mm, empuñadura en D, Energía de Impacto (EPTA 05/2009) 4,2J, potencia de salida 680W, 0-1100 rpm, 0-4900 ipm, parada de rotación, Control de la Vibración, peso 4,7Kg. EQUIPO: Empuñadura lateral multiposición, maletín, 3 brocas + 2 cinceles, selector de velocidad en gatillo con cambio de dirección.

FR Marteau léger combiné 1050W 3 modes SDS-Plus avec changement rapide du mandrin 32mm, poignée en D, Energie de choc (EPTA 05/2009) 4.2J, puissance de sortie 680W, 0-1100 tr / min, 0-4900 ipm, arrêt de la rotation, Contrôle de vibration, poids 4,7 kg. ÉQUIPEMENT: Poignée latérale multi-positions, mallette, 3 foret + 2 burins, sélecteur vitesse de déclenchement avec changement de direction.

EN 1050W combined rotary hammer drill with 3 SDS-Plus Modes, quick-change drill chuck 32mm, D-Handle, impact energy (EPTA 05/2009) 4.2J, output power 680W, 0-1100 rpm, 0-4900 ipm, stop rotation, vibration control, weight 4.7kg. EQUIPMENT: multi-position side handle, carrying case, 3 drill bits + 2 chisels, speed selector in trigger with turning direction.

IT Martello perforatore combinato 1050W con 3 modi SDS-Plus, cambio rapido di mandrino 32mm, impugnatura in D, energia d'urto (EPTA 05/2009) 4.2J, potenza in uscita 680W, 0-1100 rpm, 0-4900 ipm, la rotazione di arresto, controllo delle vibrazioni, peso 4,7kg. EQUIPAGGIAMENTO: impugnatura laterale multiposizione, valigetta, 3 punte di trapano + 2 scalpelli, selettore da velocità in grilletto con senso di rotazione.

PT Martelo Ligeiro Combinado 1050W 3 Modos SDS-Plus com mudança rápida de portabrocas 32mm, suporte em D, Energia de Impacto (EPTA 05/2009) 4,2J, potencia de saída 680W, 0-1100 rpm, 0-4900 ipm, paragem de rotação, Control da Vibração, peso 4,7Kg. EQUIPAMENTO: suporte lateral multiposição, mala, 3 brocas + 2 cinzeis, selector de velocidade no gatilho com mudança de direção.

ES **Mango en D. y control de vibración.**

FR **Poignée en D. et contrôle de la vibration.**

EN **With a D-Handle & Vibration Control.**

IT **Impugnatura in D e controllo delle vibrazioni.**

PT **Cabo em D. Control de vibração.**

Ref	⌚	⚡	W	🔧	📊	📦
5000 1223	0 - 1100 rpm	220 - 240 V	1050 W	0 - 4900 ipm	4,7 kg	207,90



MARTILLO PERFORADOR SDS PLUS 1500W / MARTEAU PERFORATEUR SDS PLUS 1500W / SDS PLUS ROTARY HAMMER 1500W  
MARTELLI PERFORATORI SDS PLUS 1500W / MARTELO PERFORADOR SDS PLUS 1500W



1.500 W

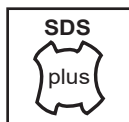

**Contenido Kit / The kit contains:**

- Mango auxiliar / Secondary side handle - 1 pc
- Medidor profundidad / Depth gauge - 1 pc
- Cinzel punta / Bull point chisel 14x250 - 1 pc
- Cinzel plano / Cold chisel 14x250 - 1 pc
- Brocas SDS Plus / SDS Plus Bits - 3 pc - Ø 8/10/12x150mm

ES	Tensión nominal / Rated voltage	220-240 V
EN	Frecuencia / Frequency	50/60 Hz
	Potencia entrada / Input power	1.500 W (12 A)
	Velocidad / Speed	950 RPM
	Impactos / Impacts	4.100 /min
	Potencia carrera / Impact energy	7.0 Julios
	Ø Máxima perforación (Hormigón) / Ø Maximum drilling (concrete)	Ø 36 mm

ES 4 funciones. Energía de alto impacto 7J. Sistema antivibraciones. Asa auxiliar adicional con agarre suave. Caja de engranajes de aluminio fundido a presión. SDS plus.

FR 4 fonctions. Énergie à impact élevé 7J. Système anti-vibration. Poignée auxiliaire supplémentaire avec prise souple. Boîte à engrenages en aluminium fondu sous pression. SDS plus.

EN 4 functions. High energy impact of 7J. Anti-vibration system. Additional secondary side handle with soft grip. Castdie aluminium gearbox. SDS plus.

IT 4 funzioni. Energia ad alto impatto di 7J. Sistema antibivibrante. Impugnatura supplementare con presa morbida. Scatola di ingranaggi in alluminio pressofuso. SDS Plus.

PT 4 funções. Energia de alto impacto 7J. Sistema anti-vibração. Alça auxiliar adicional com aderência suave. Caixa de velocidades em alumínio fundido. SDS plus.

Ref	Max. P	
5000 1233	1500 W	204,75



MARTILLO PERFORADOR SDS MAX / PERCEUSE MARTEAU PERFOREUSE SDS MAX / SDS MAX ROTARY HAMMER  
MARTELLI PERFORATORI SDS MAX / APARAFUSADORA DE MARTELO PREFURADOR SDS MAX



1.500 W



**Contenido Kit / The kit contains:**

**Mango auxiliar / Secondary side handle - 1 pc**

**Broca / Bit 18x320 mm - 1 pc**

**Cinzel / Chisel 22x320 mm - 1 pc**

**Medidor profundidad / Depth gauge - 1 pc**

ES	Tensión nominal / Rated voltage	220-240 V
EN	Frecuencia / Frequency	50/60 Hz
	Potencia entrada / Input voltage	1.500 W (12 A)
	Velocidad / Speed	410 RPM
	Impactos / Impacts	3.600 /min
	Potencia carrera / Impact energy	12 Julios
	Ø Máxima perforación (Hormigón) / Ø Máxim drilling (Concrete)	46 mm

ES Tres funciones. Energía de alto impacto 12J. Sistema antivibraciones. Mango auxiliar adicional con agarre suave. Caja de engranajes de aluminio fundido a presión. SDS máx.

FR Trois fonctions. Énergie à fort impact 12J. Système anti-vibration. Poignée auxiliaire supplémentaire avec prise souple. Boîte à engrenage en aluminium fondu sous pression. SDS max.

EN Three functions. High-impact energy of 12J. Anti-vibration system. Additional secondary side handle with soft grip. Die-cast aluminium gearbox. SDS max.

IT 3 funzioni. Energia ad alto impatto di 12J. Sistema antivibrante. Impugnatura supplementare con presa morbida. Scatola di ingranaggi in alluminio pressofuso. SDS MAX.

PT Três funções. Energia de alto impacto 12J. Sistema anti vibração. Pega auxiliar adicional com agarre suave. Caixa de velocidades em alumínio fundido. SDS máx.

Ref	Max. P	
5000 1232	1500 W	285,75



GENERADOR 208 C.C. 3,0 KW MODELO REGINA / GROUPE ELECTROGENE 208CC 3,0KW MODÈLE REGINA / GENERATOR 208CC 3KW, MODEL "REGINA"  
 GENERATORI 208CC 3,0KW MODELLO "REGINA" / GERADOR 208CC 3,0KW MODELO REGINA

MOD. REGINA



208 CC  
3.0 KVA



ES	Regulación voltaje / Voltage regulation	AVR
EN	Motor / Engine	4 T
	Cilindrada / Displacement	208 cc
	Combustible utilizado / Fuel	Gasolina / Petrol
	Voltaje dc / DC voltage	12 V - 8 A
	Corriente alterna / Alternating current	230/50 V / Hz
	Potencia máxima / Maximum power	3.0 kVA
	Potencia nominal / Rated power	2.8 kVA
	Capacidad depósito gasolina / Fuel tank capacity	15 l
	Autonomía / Run time	9 horas / hours
	Peso / Weight	45 kg
	Consumo específico / Specific consumption	360 g/kw/h
	Nivel de potencia acústica ponderado / Weighted sound power level	93.77 dB
	Nivel de potencia acústica garantizada / Guaranteed sound power level	96 dB

ES Generador con motor de cuatro tiempos y regulación automática del voltaje en función de la carga demandada (AVR). Pantalla digital con información de voltaje, frecuencia y horas de uso. Dos enchufes AC "tipo F" estándar CEE 7/4 "Schuko" con tapa. Salida DC 12V -8A con posibilidad de carga de baterías. Chasis de acero perimetral.

FR Générateur avec moteur à quatre temps et régulation automatique de la tension en fonction de la charge demandée (AVR). Affichage numérique avec des informations sur la tension, la fréquence et les heures d'utilisation. Deux prises AC standard "type F" CEE 7/4 "Schuko" avec couvercle. Sortie DC 12V -8A avec possibilité de chargement de batteries. Châssis périphérique en acier.

EN This generator has a 4-stroke engine and an automatic voltage regulator according to the demanded load (AVR). LED display with voltage, frequency and operating hours readings. Two AC CEE 7/4 plug Schuko with cover. DC 12V-8A output with the possibility of charging batteries. Surrounded steel chassis.

IT Questo generatore ha un motore a 4 tempi e una regolazione automatica di voltaggio seconda dal carico domandato (AVR) Display LED che mostra gli informazioni sulla tensione, frequenza e le ore di funzionamento. Due spine AC di tipo F, standard CEE 7/4, definite anche come "Schuko", con copperchio. Uscita C.C. 12V-8A con la possibilità di caricare le batterie. Telaio in acciaio perimetrale.

PT Gerador com motor a quatro tempos e regulação automática de tensão com base na carga demandada (AVR). Display digital com informações sobre tensão, frequência e horas de uso. Dois plugues CA "tipo F" padrão CEE 7/4 "Schuko" com tampa. Saída DC 12V -8A com a possibilidade de carregar baterias. Chassis de aço de perímetro.

Ref	Max. P	CC			
7100 1022	3 Kw	208 cc	15 L	45 kg	585,40





GENERADOR 389CC 5,5 KVA 2 SALIDAS AC 1 DC MOD. GEORGIA / GROUPE ELECTROGENE 210CC 2 SORTIES AC 1 DC MOD. GEORGIA  
 210CC GENERATOR 2 AC 1DC OUTPUTS MOD. GEORGIA / GENERATORE 210CC 2 USCITE AC 1 DC MOD. GEORGIA  
 GERADOR 210CC 2 SAÍDAS AC 1 DC MOD. GEORGIA



MOD. GEORGIA

389 CC  
5.5 KVA



ES	Regulación voltaje / Voltage regulation	AVR
EN	Motor / Engine	4 Tiempos / 4-stroke
	Cilindrada / Displacement	389 cc
	Combustible utilizado / Fuel	Gasolina / Petrol
	Voltaje dc / DC voltage	12 V
	Corriente alterna / Alternating current	230 V / 50 Hz
	Potencia máxima / Maximum power	5,5 kVA
	Potencia nominal / Rated power	5,0 kVA
	Capacidad depósito gasolina / Fuel tank capacity	25 l
	Autonomía / Run time	5,5 horas
	Peso / Weight	82 kg
	Consumo específico / Specific consumption	313 g/kw/h
	Nivel de potencia acústica ponderado / Weighted sound power level	95 dB
	Nivel de potencia acústica garantizada / Guaranteed sound power level	96 dB

ES Generador con motor 4 tiempos y regulación automática del voltaje en función de la carga demandada (AVR). Arranque eléctrico con llave de contacto. Pantalla LED electrónica con información de voltaje, frecuencia y horas de uso. Dos enchufes AC "schuko" con tapa y salida DC con posibilidad de carga de baterías. Chasis de acero perimetral con asas escamoteables y ruedas de transporte. Batería (12V 10AH) incluida. 96 db de sonido.

FR Générateur avec moteur 4 temps et régulation de tension automatique en fonction de la charge demandée (AVR). Démarrage électrique avec clé de contact. Affichage à LED électronique avec des informations sur la tension, la fréquence et les heures d'utilisation. Deux prises AC «schuko» avec couvercle et sortie CC avec la possibilité de charger des batteries. Châssis périmétrique en acier avec poignées rétractables et roues de transport. Batterie (12V 10AH) incluse. 96 dB de son.

EN This generator has a 4-stroke engine and an automatic voltage regulator according to the demand load (AVR). It also has an electric starting with an ignition key, a LED display with voltage, frequency and operating hours readings. Two "Schuko" AC plugs with cover, and DC output with the possibility of charging batteries, are incorporated. Surrounded steel chassis with retractable handles and transport wheels. The battery (120V 10AH) is included with a sound power of 96 dB.

IT Questo generatore ha un motore a 4 tempi e una regolazione automatica di voltaggio seconda dal carico domandato (AVR). È dotato inoltre di un avviamento elettrico con una chiave di accensione, un display LED che mostra gli informazioni sulla tensione, frequenza e le ore di funzionamento. Due spina CA "Schuko" con coperchio e uscita DC con la possibilità di ricaricare le batterie. Telaio in acciaio perimetrale con maniglie a scomparsa e ruote di trasporto. Batteria (12V 10AH) inclusa. Potenza sonora di 96 dB.

PT Gerador com motor de 4 tempos e regulação automática da tensão dependendo da carga demandada (AVR). Arranque eléctrico com chave de contacto. Visor LED electrónico com informação de tensão, frequência e horas de uso. Duas fichas AC «schuko» com tampa e saída DC com possibilidade de recarregar baterias. Chasis de aço perimetral com alças retráteis e rodas de transporte. Batería (12V 10AH) incluída. 96 db de som.

Ref	Max. P	CC			
7100 1021	5,5 Kw	389 cc	25 L	82 kg	1250,20



CORTACÉSPED AUTOPROPULSADO 139CC MOD. MAINE / TONDEUSE À GAZON AUTOMOTRICE 139CC MOD. MAINE / 139CC SELF-PROPELLED LAWNMOWER MOD. MAINE / TAGLIAERBA SEMOVENTE 139CC MOD. MAINE / CORTA RELVAS DE AUTOPROPULSÃO 139CC MOD. MAINE



139 CC



ES	Motor / Engine	<b>4 tiempos / strokes</b>
EN	Cilindrada / Engine Displacement	<b>139 cc OHV</b>
	Anchura de corte / Cutting width	<b>46 cm</b>
	Freno de cuchilla / Blade brake	<b>SÍ / YES</b>
	Altura de corte / Mowing height	<b>8 (25-75 mm) / 8 (25-75 mm)</b>
	Capacidad saco recogedor / Grass catcher bag capacity	<b>55 L / 55 L</b>
	Tipo de carcasa / Chassis design	<b>ACERO / STEEL</b>
	Tracción / Traction	<b>SÍ / YES</b>
	Capacidad aceite cárter / Crankcase oil capacity	<b>0,6 L</b>
	Nivel de vibración (m/s <sup>2</sup> ) (K=1,5) / Vibration level (m/s <sup>2</sup> ) (K=1,5)	<b>- 5</b>
	Nivel presión sonora LpA (dB(A)) / Sound pressure level LpA (dB(A))	<b>-83</b>
	Peso / Weight	<b>32 kg</b>

ES Autopropulsado con ruedas con rodamiento

FR Automotrice avec des roues et roulement

EN Self-propelled lawnmower with wheels and bearing

IT Semovente con ruote e cuscinetto

PT Auto propulsado com rodas, com rolamentos

ES Cortacésped de 46cm de ancho de corte con chasis de acero autopropulsado con una nueva carcasa de acero que mejora la recogida y una manilla regulable en altura (3 posiciones), con montaje sin herramientas y con pomos de plegado rápido. Motor con válvulas en cabeza, cebador, aire automático y acelerador autorregulable.

FR Tondeuse à gazon coupe 46 cm de large avec châssis en acier autoporté, nouvelle carcasse en acier améliorant la collecte et une poignée réglable en hauteur (3 positions), avec montage sans outil et pommeaux à rabat rapide. Moteur avec valves en tête, démarreur, air automatique et accélérateur automatique.

EN Lawnmower 46cm cutting width with a self-propelled steel chassis, a new steel housing that ensures an improvement in collection, and a height-adjustable handle (3 positions); it could be mounted without any tools and also has a quick folding handle. Engine with overhead valves, starter, automatic blow and self-regulating accelerator.

IT Tagliaerba de 46cm larghezza di taglio, scocca in acciaio semovente, un nuovo alloggiamento che garantisce un miglioramento della raccolta e impugnatura ad altezza regolabile (3 posizioni), con montaggio senza uso di attrezzi e l'impugnatura si piega velocemente. Motore con valvole in testa, starter, aria automatica e acceleratore a regolazione automatica.

PT Corta relvas com 46 cm de largura de corte com o Chasis de aço de autopropulsão com um puchador regulável em altura (3 posições), com montagem sem ferramentas e com botões de dobragem rápida. Motor com válvulas á frente, purgador, ar automático e acelerador autoregulável.

Ref	CC	Kw					
<b>7100 1009</b>	139	2,2	1,2 L	25 - 75 mm	460 mm	32 kg	<b>524,90</b>



MOTOAZADA CUCHILLAS DE ACERO Ø37 CM MOD. KANSAS / MOTOBINEUSE LAMES EN ACIER Ø37 CM MOD. KANSAS  
 MOTOR HOE WITH Ø37 CM STEEL BLADES MOD. KANSAS / MOTOZAPPE LAME IN ACCIAIO Ø37CM MOD. KANSAS  
 MOTO-ENXADA LÂMINAS DE AÇO Ø37CM MOD. KANSAS



MOD. KANSAS

196 CC



ES Motoazada de gran calidad con caja de cambios de 2 velocidades hacia adelante y otra hacia atrás. Ideal para medianas y grandes huertas equipada con caja de cambios y embrague de doble correa. Ideal para terrenos de 200 metros a 1500m. Máquina ágil y potente. Manilla regulable en altura.

FR Motobineuse de haute qualité avec boîte de vitesses de 2 vitesses vers l'avant et une vers l'arrière. Idéal pour les terrains moyens à grands ; Equipée d'une boîte de vitesses et d'un embrayage à double courroie. Idéal pour terrain de 200 mètres à 1500m. Machine agile et puissante. Poignée réglable en hauteur.

EN This high quality motor hoe incorporates a gearbox with 3 speeds, 2 forward and 1 reverse. It is ideal for medium-sized and big vegetable gardens; it is also equiped with a gearbox and a double clutch. The motor hoe is perfect for plots of land from 200 to 1,500 metres. Powerful and flexible machine. Handlebar with adjustable height.

IT Motozappa di altissima qualità con cambio di 2 marcia avanti e 1 retromarcia. È ideale per orti medie e grandi; inoltre è attrezzato con un cambio e frizione doppia cinghia. Perfetto per gli pezzo di terra da 20 a 1.500 metri. Macchina potente e agile. Asta di profondità regolabile.

PT Motoenchada de grande qualidade comcaixa de mudanças de 2 velocidades para a frente e outra para detrás. Ideal para hortas medianas e grandes, equipada com caixa de mudanças e embraiagem de dupla corrente. Ideal para terrenos de 200 metros a 1500m. Máquina ágil e potente. Manilha regulável em altura.

ES	Motor / Engine	4 tiempos / strokes
EN	Cilindrada / Displacement	196 cm <sup>3</sup>
	Potencia máxima / Peak power	3,8 Kw / 5,09 Cv
	Nº de fresas / Number of hoes	6
	Ancho cuchillas / Cutter width	37 cm
	Anchura de trabajo / Working width	73 cm
	Capacidad del depósito de combustible / Fuel tank capacity	3,6 l
	Capacidad de aceite en el cárter / Crankcase oil capacity	0,6 l
	Velocidades / Speeds	2 adelante / 1 atrás
	Nivel de vibración en el manillar / Handlebar vibration level	7,2 m/s <sup>2</sup>
	Nivel de potencia sonora media / Average sound power level	87,4 dB
	Nivel de potencia sonora garantizada / Guaranteed sound power level	101,1 dB
	Peso / Weight	70 kg

Ref	Kw/Cv				
7100 1031	3,8 / 5,09	3,6 L	73 cm	70 kg	795,60



KIT APORCADOR + PAR DE RUEDAS METÁLICAS  
 BUTTOIR RÉGLABLE + ROUES EN MÉTAL  
 KIT ADJUSTABLE FURROWER + A PAIR OF METAL WHEELS  
 ASSOLCATORE REGOLABILE + COPPIA RUOTE METALLICHE  
 KIT MOTO-ENXADA + PAR DE RODAS METÁLICAS

Ref	
7100 1031.01	289,00



PAR DE RUEDAS NEUMATICAS MOTOAZADA / JEU DE ROUES PNEUMATIQUES  
 PAIR OF PNEUMATIC TIRES / COPPIA ROUTE PNEUMATICHE  
 PAR DE RODAS PNEUMATICAS MOTO-ENCHADA

Ref	
7100 1031.03	172,20



SOPLADOR DE MOCHILA MOD.MONTANA 63,3CC / SOUFFLEUR À DOS MOD. MONTANA 63,3CC / 63.3CC BACKPACK BLOWER MOD. MONTANA  
SOFFIATORE A ZAINO MOD. MONTANA 63,3CC / SOPRADOR DE MOCHILA MOD. MONTANA 63,3CC



MOD. MONTANA

63,3 CC



ES	Motor / Engine	2 tiempos / strokes
EN	Cilindrada / Displacement	63,3 cm <sup>3</sup>
	Potencia máxima / Peak power	2,7 Kw / 3,62 Cv
	Regimen de giro al ralentí / Engine idling speed	2.800 min <sup>-1</sup>
	Regimen máximo de giro del motor / Maximum engine speed	6.100 min <sup>-1</sup>
	Velocidad del aire / Air velocity	380 km/h
	Volumen del aire / Air volume	19,2 cm <sup>3</sup> /min
	Combustible / Fuel	Gasolina más aceite para motores de 2 tiempos al 2,5% / Petrol plus oil for the 2-stroke engine at 2,5%
	Depósito de combustible / Fuel tank	2,3 l
	Caudal máximo de aire / Maximum airflow	0,46 m <sup>3</sup> /s
	Nivel de potencia sonora garantizada / Guaranteed sound power level	118 db
	Nivel de vibración en la empuñadura / Handle vibration level	9,1 m/s <sup>2</sup>
	Peso / Weight	10,5 kg

ES Soplador de mochila para limpieza de calles, parques y grandes superficies, con filtro de aire sobredimensionado en posición superior. Cuenta con un nuevo diseño de las aletas del ventilador para conseguir mayor volumen de aire a las mismas revoluciones, permitiendo la reducción de ruido y el consumo de combustible.

FR Souffleur à dos pour le nettoyage des rues, parcs et grands espaces, avec filtre à air surdimensionné en position haute. Il présente un nouveau design des ailettes du ventilateur pour obtenir un plus grand volume d'air aux mêmes rotations, ce qui permet de réduire le bruit et la consommation de carburant.

EN The backpack blower is intended for cleaning streets, parks and large surfaces. It has an oversize air filter in its upper position. It has a new flaps design on its fan with the aim to get an increased air volume in the same revolutions, reducing the noise and fuel consumption.

IT Soffiatore a zaino per la pulizia di strade, parchi e grandi superfici. Ha un filtro dell'aria sovradimensionato nella posizione superiore. Nuovo design delle pale del ventilatore per un maggiore volume d'aria nelle stesse rivoluzioni riducendo il livello di rumore e il consumo di carburante.

PT Soprador de mochila para limpeza de ruas, parques e grandes superfícies, com filtro de ar sobredimensionado. Desenho especial das alhetas do ventilador para um maior caudal de ar, menor rotação reduzindo o ruído bem como o consumo.

Ref	CC	Kw/Cv			
7100 1010	63,3	2,7 / 3,62	2,3 L	10,5 kg	489,40





DESBROZADORA MOD. ALABAMA 52CC DOBLE MANILLAR TUBO 28 MM / DEBROUSSAILLEUSE MOD. ALABAMA 52 CC DOUBLE GUIDON TUBE 28 MM  
 52CC STRING TRIMMER MOD. ALABAMA U-TYPE HANDLEBAR 28MM / DECESPUGLIATORE MOD. ALABAMA 52CC DOPPIO MANICO TUBO 28MM  
 ROÇADORA MOD. ALABAMA 52CC DUPLO VOLANTE TUBO 28MM

MOD. ALABAMA

52 CC



Incluye / Inclus / Includes / Includi / Includi:

ES Desbrozadora con motor 2 tiempos de 52 CC. Con cebador, sistema antivibración, cabezal de dos hilos y disco de corte. Incluye manillar y arnés de tipo doble. Máquina muy versátil para trabajar.

FR Amorce, système anti-vibration, tête à deux fils et disque de coupe. Comprend un guidon et un harnais de type double. Machine très polyvalente pour travailler.

EN String trimmer with 2-stroke engine of 52cc, starter and anti-vibration systems, 2-line trimmer head and cutting disc. It includes U-type handlebar and a double shoulder harness. A very versatile machine for work.

IT Decespugliatore con un motore a 2 tempi di 52cc, dispositivo di avviamento, sistema antivibrazione, testina a 2 fili e disco. Includi un manico doppio e imbracatura a doppia spalla. Macchina molto versatile per lavorare.

PT Roçadoura com motor 2 tempos de 52 cc, com dupla injeção de gasolina, sistema anti-vibração, cabeça de dois fios e disco de corte. Includi guiador e arnés de tipo duplo. Máquina muito versátil para trabalhar.

Motor			<b>2 tiempos</b>
Cilindrada (cm <sup>3</sup> )			<b>52 cc</b>
Potencia máxima (kW/Cv)			<b>1,55 Kw / 2,08 Cv</b>
Régimen de giro del motor al ralentí (min <sup>-1</sup> )			<b>3.000</b>
Régimen máximo de giro del motor (min <sup>-1</sup> )			<b>9.000</b>
Régimen máximo de giro del eje de la herramienta (min <sup>-1</sup> )			<b>6.700</b>
Consumo de combustible a máxima potencia (ISO8893) (kg/h)			<b>≤ 0,900</b>
Capacidad del depósito (litros)			<b>1,25 l</b>
Herramienta de corte	Diámetro de corte (mm)	cuchilla	<b>255 mm</b>
		hilo de nylon	<b>420 mm</b>
	Espesor herramienta de corte (mm)	cuchilla	<b>1,6 mm (cuchilla de punta afilada)</b>
		hilo de nylon	<b>Ø 2,5 mm</b>
	Número de filos de corte	cuchilla	<b>3 dientes (cuchilla de metal)</b>
		hilo de nylon	<b>2 hilos flexibles (cabezal de corte de nylon)</b>
Diámetro interior de la cuchilla (mm)			<b>254 mm</b>
Máxima velocidad permitida de corte (min <sup>-1</sup> )	cuchilla	<b>9.000</b>	
	hilo de nylon	<b>10.000</b>	
Niveles de vibración (ISO 22867) (m/s <sup>2</sup> )			<b>≤ 9 m/s<sup>2</sup></b>
Niveles de presión sonora (ISO 22868) LpA dB(A)			<b>96 db</b>
Nivel de potencia sonora garantizado (ISO 22868) LwA dB(A)			<b>114 db</b>
Transmisión			<b>28 mm</b>
Peso (kg)			<b>8,4 kg</b>

Ref	CC	Kw/Cv				
<b>7100 1005</b>	52	1,55 / 2,08	1,25 L	28 mm	8,4 kg	<b>244,71</b>

HILO REDONDO PARA DESBROZADORA / FIL ROND POUR DÉBROUSSAILLEUSE / ROUND STRING TRIMMER LINE  
 FILO TONDO PER DECESPUGLIATORE / FILO REDONDO PARA MOTO ROÇADOURA



Ref				
<b>7100 1005.01</b>	81 m x 2,5 mm	1	<b>15,99</b>	✓
<b>7100 1005.02</b>	54 m x 3 mm	1	<b>15,99</b>	✓

**CUCHILLA DESBROZADORA 2D ZARZA / LAME POUR DÉBROUSSAILLEUSE 2D RONCE / 2D STRING TRIMMER BLADE BRAMBLE  
LAMA PER DECESPUGLIATORE 2D ROVO / LAMINA DE MOTO ROÇADOURA 2D ZARZA**
**ACERO / STEEL**

ES Para trabajos de triturado de maleza y zarzas. Apto para máquinas de entre 34cc y 52cc.  
FR Pour les travaux de broyage de mauvaises herbes et de ronces. Convient aux machines entre 34cc et 52cc.  
EN Ideal for shredding weeds and brambles. Suitable for machines between 34cc & 52cc.  
IT Per lavori di far scricchiolare macchia e rovi. Indicato per macchine tra 34cc e 52cc.  
PT Para trabalhos de trituração de ervas daninhas e silvas. Apto para máquinas entre 34cc e 25cc.



Ref	CC			
<b>7100 1005.05</b>	34 - 40 cc	255 x 25,4 x 3,0 mm	<b>9,43</b>	✓
<b>7100 1005.06</b>	+ 40 cc	310 x 25,4 x 3,5 mm	<b>10,66</b>	✓

**CUCHILLA DESBROZADORA 3D MATORRAL / LAME POUR DÉBROUSSAILLEUSE 3D MAUVAISE HERBE / 3D STRING TRIMMER BLADE WEED MOWING  
LAMA PER DECESPUGLIATORE 3D ERBACCE / LAMINA DE MOTO ROÇADOURA 3D MATORRAL**
**ACERO / STEEL**

ES Para trabajos de corte de hierba resistente y matorrales. Apto para máquinas de más de 25cc.  
FR Pour les travaux de coupe d'herbes résistantes et broussailles. Convient aux machines de plus de 25cc.  
EN Ideal for cutting salt-resistant grass and shrublands. Suitable for machines of more than 25cc.  
IT Per lavori di taglio di erba resistente e erbacce. Indicato per macchine di più di 25cc.  
PT Para trabalhos de corte de erva resistente e arvoredos. Apto para máquinas com mais de 25cc.



Ref	CC			
<b>7100 1005.03</b>	+ 25 cc	230 x 25,4 x 1,4 mm	<b>7,38</b>	✓
<b>7100 1005.04</b>	+ 30 cc	255 x 25,4 x 1,4 mm	<b>9,02</b>	✓

**CUCHILLA DESBROZADORA 4D MATORRAL / LAME POUR DÉBROUSSAILLEUSE 4D MAUVAISE HERBE / 4D STRING TRIMMER BLADE WEED MOWING  
LAMA PER DECESPUGLIATORE 4D ERBACCE / LAMINA DE MOTO ROÇADOURA 4D MATORRAL**
**ACERO / STEEL**

ES Para trabajos de corte de hierba resistente y matorrales. Apto para máquinas de más de 25cc.  
FR Pour les travaux de coupe d'herbes résistantes et feuillages. Convient aux machines de plus de 25cc.  
EN Ideal for cutting salt-resistant grass and shrublands. Suitable for machines of more than 25cc.  
IT Per lavori di taglio di erba resistente e erbacce. Indicato per macchine di più di 25cc.  
PT Para trabalhos de corte de erva resistente e arvoredos. Apto para máquinas com mais de 25cc.



Ref	CC			
<b>7100 1005.07</b>	+ 25 cc	230 x 25,4 x 1,4 mm	<b>7,80</b>	✓
<b>7100 1005.08</b>	+ 30 cc	255 x 25,4 x 1,4 mm	<b>9,43</b>	✓

**DISCO DESBROZADORA 80D ARBUSTO/ARBOL / DISQUE POUR DÉBROUSSAILLEUSE ARBUSTE/ARBRE 80D / 80D STRING TRIMMER BRUSH CUTTER FOR BUSH/TREE  
DISCO PER DECESPUGLIATORE 80D ARBUSTO/ALBERO / DISCO PARA MOTO ROÇADOURA 80D ARBUSTOS/ARVORES**
**ACERO / STEEL**

ES Para trabajos de corte de arbustos y árboles finos. Apto para máquinas de más de 25cc.  
FR Pour des travaux de coupe d'arbustes et d'arbres fins. Convient aux machines de plus de 25cc.  
EN Ideal for cutting bushes and small trees. Suitable for machines of more than 25cc.  
IT Per lavori di taglio di arbusti e alberi piccoli. Indicato per macchine di più di 25cc.  
PT Para trabalhos de corte de arbusto e árvores finas. Apto para máquinas com mais de 25cc.



Ref	CC			
<b>7100 1005.09</b>	+ 25 cc	230 x 25,4 x 1,8 mm	<b>9,84</b>	✓
<b>7100 1005.10</b>	+ 30 cc	255 x 25,4 x 1,8 mm	<b>10,25</b>	✓

**DISCO DESBROZADORA 8D BROZA/ARBUSTO / DISQUE POUR DÉBROUSSAILLEUSE ARBUSTE/ARBRE 8D / 8D STRING TRIMMER BRUSH CUTTER FOR LEAFMOLD/BUSH  
DISCO PER DECESPUGLIATORE 8D VEGETAZIONE BASSA/ARBUSTO / DISCO PARA MOTO ROÇADOURA 8D ARBUSTOS/ARVORES**
**ACERO / STEEL**

ES Para trabajos de corte de broza y arbustos. Apto para máquinas de más de 25cc.  
FR Pour les travaux de coupe de broussailles et d'arbustes. Convient aux machines de plus de 25cc.  
EN Ideal for cutting brush and bushes. Suitable for machines of more than 25cc.  
IT Per lavori di taglio di bassa e arbusti. Indicato per macchine di più di 25cc.  
PT Para trabalhos de corte de erva seca e arbustos. Apto para máquinas com mais de 25cc.



Ref	CC			
<b>7100 1005.11</b>	+ 25 cc	230 x 25,4 x 1,4 mm	<b>7,80</b>	✓
<b>7100 1005.12</b>	+ 30 cc	255 x 25,4 x 1,6 mm	<b>9,43</b>	✓



MOTOBOMBA GASOLINA 40,2CC ENTRADA Y SALIDA 1,5" MOD.NEVADA / MOTOPOMPE 40,2CC ENTRÉE ET SORTIE 1,5" MOD. NEVADA  
 WATER PUMP 40.2CC INLET & OUTLET 1.5" MOD. NEVADA / MOTOPOMPA 40,2CC INGRESSO E USCITA 1,5" MOD. NEVADA  
 MOTOBOMBA GASOLINA 40,2CC ENTRADA E SAÍDA 1,5" MOD. NEVADA



**MOD. NEVADA**

**40,2 CC**



ES Codo orientable de 1,5"  
 FR Coude réglable de 1,5"  
 EN Adjustable elbow joint 1,5"  
 IT Gomito regolabile 1,5"  
 PT Saída orientável de 1,5"

ES EN	Motor / Engine	<b>2 tiempos / strokes</b>
	Cilindrada / Displacement	<b>40,2 cc</b>
	Potencia / Power	<b>1,45 Kw / 2,0 Cv</b>
	Combustible / Fuel	<b>Mezcla de gasolina sin plomo 95 octanos con aceite para motores de 2 tiempos al 2,5% / Mixture of 95 octane unleaded petrol and oil for 2-stroke engine at 2,5%</b>
	Capacidad depósito de combustible / Fuel tank capacity	<b>0,95 l</b>
	Caudal máximo / Maximum flow	<b>13.000 l/h</b>
	Altura máxima de impulsión / Maximum discharge head	<b>20 m</b>
	Altura máxima de aspiración / Maximum suction head	<b>8 m</b>
	Nivel de potencia sonora garantizado / Guaranteed sound power level	<b>114 db</b>
	Peso / Weight	<b>8 kg</b>

ES Motobomba de agua ligera y potente con con 1,45 kW y solo 8 kg de peso, equipada con motor 2 tiempos de 40.2 cc puede mover hasta 15.000 l de agua por hora y alcanzar una impulsión de 35 m, perfecta para tareas de nivel medio. Con sistema autoaspirante con cebador de bomba y aspira hasta 8 m de altura.

FR Pompe à eau légère et puissante de 1,45 kW et d'un poids de 8 kg seulement, équipée d'un moteur 2 temps de 40,2 cm<sup>3</sup>, peut déplacer jusqu'à 15 000 litres d'eau par heure et atteindre une distance de 35 m; parfait pour les tâches de niveau moyen. Avec système auto-aspirant avec amorce de pompe et aspire jusqu'à 8 m de haut.

EN This light and powerful water pump with 1.45kW only weights 8kg; it is equipped with a 2-stroke engine of 40.2cc, can move up to 15,000l of water per hour and it can reach a propulsion up to 35m; it is ideal for middle-level tasks. With a self-priming system, primer pump and Hoover up to 8m high.

IT Questa motopompa è più leggera e più facile da trasportare con soltanto un peso di 8kg, 1,45kW e un motorino a 2 tempi di 40,2cc, può spostare fino a 15.000l di acqua all'ora e raggiungere una propulsione di 35m; ideale per compiti di livello intermedio. Con un sistema di autoadescante, primer per pompa e aspirare fino a 8m d'altezza.

PT Motobomba de água ligeira e potente com 1.45kw e peso de 8kg, motor de 2 tempos de 40.2cm<sup>3</sup> por hora, caudal de 15m<sup>3</sup> e pode alcançar uma impulsão de 35m; perfeita para tarefas de nível médio. Bomba auto-ferrante e auto-aspirante com capacidade de aspiração de 8m de altura na vertical.

Ref	CC	Kw/Cv			
<b>7100 1011</b>	40,2	1,45 / 2,0	0,95 L	8 kg	<b>296,30</b>



ELECTROBOMBA SUMERGIBLE 750W CABLE 10M / ELECTROPOMPE SUBMERSIBLE 750W CABLE 10M / 750W SUBMERSIBLE WATERPUMP 10M CABLE  
ELETTROPOMPA SOMMERSIBILE 750W CAVO 10M / ELECTROBOMBA SUMERSÍVEL 750W CABO 10M



MOD. INDIANA

750 W



Caudal / Débit / Flow  
Portata / Caudal

7	4.500
6	6.500
4	9.500
2	11.500
metros	l/h aprox.

ES	Potencia máxima / Maximum power	750 W
EN	Voltaje / Voltage	230 V
	Frecuencia / Frequency	50 Hz
	Clase de protección / Protection class	Clase I / Class I
	Grado de protección contra humedad / Degree of protection against moisture	IPX8
	Caudal máximo / Maximum flow rate	13.000 l/h
	Altura máxima de impulsión / Maximum discharge head	8 m
	Inmersión máxima / Minimum immersion depth	7 m
	Diámetro máximo de los cuerpos a bombear / Maximum diameter of the bodies to be pumped	35 mm
	Diámetro de racor de salida de agua / Elbow diameter	1", 1 1/4", 1 1/2"
	Longitud cable alimentación H07RN-F 3G 1.0 mm <sup>2</sup> / Power cable length H07RN-F 3G 1.0 mm <sup>2</sup>	10 m
	Temperatura máxima del agua a aspirar / Maximum suction liquid temperature	35 °C
	Peso / Weight	5,5 kg

ES Bomba sumergible con carcasa de acero inoxidable de gran caudal para desalojar gran cantidad de agua en pocos minutos. Especialmente diseñada para impulsar aguas sucias. Dispone de sistema de encendido y apagado automático por boya de flotación y asa de transporte. Con cable de alimentación de 10 m. Racores incluidos.

FR Pompe submersible avec boîtier en acier inoxydable à débit élevé pour déloger de grandes quantités d'eau en quelques minutes. Spécialement conçu pour vider l'eau sale. Doté d'un système d'allumage et d'arrêt automatique grâce à une bouée à flotteur et à une poignée de transport. Avec 10 m de câble d'alimentation. Aménagements inclus.

EN This submersible waterpump with a stainless steel housing body has a great flow rate in order to lift water in a short period of time. It is specially designed to sustain dirty water. An automatic ignition and shutdown system per float switch, and carry handle are fitted. It also has a power 10m cable. The elbow and connector are included.

IT Pompa sommergibile con corpo in acciaio inossidabile ha una portata grande al fine di spostare l'acqua in un periodo di tempo breve. È stato progettato specialmente per sospingere l'acqua sporca. Il prodotto ha un sistema di accensione e spegnimento dall'interruttore a galleggiante e una maniglia per il trasporto. Ha un cavo di alimentazione di 10m. I attachi sono inclusi.

PT Bomba submersível com carcaça de aço inoxidável de grande caudal. Especialmente desenhada para águas sujas. Possui sistema automático de ligar e desligar por bóia flutuante e alça de transporte. Com cabo de alimentação de 10 m. Acessórios incluídos.

Ref	Max. P	⚡	HZ	⚖️	📦
7100 1012	750 W	230 V	50 Hz	5,5 kg	155,30



LIMPIADORA ALTA PRESIÓN 1800W 5M MANGUERA / NETTOYEUR HAUTE PRESSION 1800W 5M TUYAU / 1800W PRESSURE WASHER 5M HOSE  
 IDROLAVATRICE ALTA PRESSIONE 1800W 5M TUBO / LAVADORA ALTA PRESSÃO 1800W 5M MANGUEIRA



**MOD. ARIZONA**

**1.800 W**



ES	Potencia / Power	<b>1.800 W</b>
EN	Voltaje / Voltage	<b>230 V</b>
	Frecuencia / Frequency	<b>50 Hz</b>
	Clase de protección / Protection Class	<b>Clase I / Class I</b>
	Grado de protección / Degree of Protection	<b>IPX5</b>
	Presión nominal / Nominal pressure	<b>100 bar</b>
	Presión máxima / Maximum pressure	<b>140 bar</b>
	Caudal máximo / Maximum flow rate	<b>420 l/h</b>
	Rango de temperatura de agua utilizable / Usable water temperature range	<b>5-40 °C</b>
	Presión máxima de entrada del agua / Maximum water inlet pressure	<b>12 bar</b>
	Nivel de presión sonora / Sound pressure level	<b>74,6 dB</b>
	Nivel de potencia sonora / Sound power level	<b>88,3 dB</b>
	Peso / Weight	<b>7,5 kg</b>

ES Perfecta para limpiezas en un ámbito particular. Equipada con una bomba de 3 pistones y sistema TSS con parada automática y depósito para detergente. Dispone de manguera a presión de pvc de 5 m con rosca 14 mm y pistola para lanzas de bayoneta. Incluye lanza regulable rotativa, bloqueo de seguridad y conexión rápida.

FR Parfait pour le nettoyage dans un environnement particulier. Équipé d'une pompe à 3 pistons, système TSS avec arrêt automatique et réservoir pour détergent. Possède un tuyau de pression en PVC de 5 m avec un filetage de 14 mm et un pistolet pour lances à baïonnette. Comprend une lance rotative réglable, un verrou de sécurité et une connexion rapide.

EN This pressure washer is suitable for cleaning in a particular area. It is equipped with a 3 pistons pump, a TSS system with an automatic shutdown, and an incorporated tank for the detergent. A PVC pressure hose of 5m length with a 14mm thread and a trigger gun for the spray wands are fitted. A rotative adjustable spray wand, a safety lock and quick connection are incorporated.

IT È idonea alle pulizie in un ambito particolare. È inoltre dotata d'una pompa con 3 pistoni, un sistema TSS con arresto automatico e un serbatoio per il detergente. Dispone di un tubo flessibile di pressione in PVC di 5m e una filettatura di 14mm, una pistola per le lancia. Comprende una lancia regolabile rotativa, un blocco di sicurezza e una connessione rapida.

PT Perfeita para limpezas em âmbito particular. Equipada com uma bomba de 3 pistões, sistema TSS com paragem automática e depósito para detergente. Dispõem de mangueira a pressão de PVC de 5 m com rosca de 14mm e pistola para lanças de baioneta. Inclui lança regulável rotativa, bloqueio de segurança e de rápida ligação.

Ref	Max. P	⚡	HZ	⚖️	📦
<b>7100 1013</b>	1.800 W	230 V	50 Hz	7,5 kg	<b>198,60</b>





LIMPIADORA ALTA PRESIÓN 2500W 5M MANGUERA CON DEVANADERA / NETTOYEUR HAUTE PRESSION 2500W 5M TUYAU AVEC ENROULEUR  
 2500W PRESSURE WASHER 5M HOSE WITH WINDER / IDROPULTRICE ALTA PRESSIONE 2500W 5M TUBO CON ASPO  
 LIMPIADORA ALTA PRESIÓN 2500W 5M MANGUERA CON DEVANADERA



MOD. VERMONT

2.500 W



KIT INCLUDED



ES	Potencia / Power	2.500 W
EN	Voltaje / Voltage	230 V
	Frecuencia / Frequency	50 Hz
	Clase de protección / Protection Class	Clase I / Class I
	Grado de protección / Degree of Protection	IPX5
	Presión nominal / Nominal pressure	130 bar
	Presión máxima / Maximum pressure	160 bar
	Caudal máximo / Maximum flow rate	420 l/h
	Rango de temperatura de agua utilizable / Usable water temperature range	5-50 °C
	Presión máxima de entrada del agua / Maximum water inlet pressure	10 bar
	Nivel de presión sonora / Sound pressure level	75dB
	Nivel de potencia sonora / Sound power level	86 dB
	Peso / Weight	21 kg

ES Motor de inducción eléctrico de 2.500W. Con sistema TSS de parada automática, devanadera con manguera de pvc de 5 m con conector rosca de 14 mm y depósito de detergente. Pistola para lanzas de bayoneta y kit de accesorios formado por lanza tubo regulable, tobera giratoria y cepillo de lavado fijo. Conexión rápida.

FR Moteur à induction électrique de 2500W. Avec un système TSS d'arrêt automatique un enrouleur avec un tuyau en PVC de 5 m avec un raccord fileté de 14 mm et un réservoir pour le détergent. Cela inclut un pistolet lance à baïonnette et un kit d'accessoires comprenant une lance à tube réglable, une buse rotative et une brosse de lavage fixe. Connexion rapide.

EN Pressure washer with a 2,500W electric induction motor. It is equipped with an automatic shutdown TSS system, 5m PVC hose with a reel, a 14mm thread for the connector adapter and a tank for the detergent. A trigger gun for spray wands and an accessories kit consisting of a spray wand with an adjustable pipe, a twist nozzle and a pressure washer fixed brush are incorporated. Quick connection.

IT Idropulitrice di alta pressione con motore ad induzione di 2.500W. È dotata d'un sistema TSS con arresto automatico, avvolgitubo con un tubo flessibile di 5 m in PVC con un connettore di una filettatura di 14mm e serbatoio per il detergente. Dispone inoltre di una pistola per lance, kit di accessori composto da una lancia di tubo regolabile, un ugello rotante e una spazzola di lavaggio fissa. Connessione rapida.

PT Motor de indução eléctrica de 2.500W. Com um sistema TSS de paragem automática, carretel com mangueira de PVC de 5 m e com ligação em rosca de 14mm e um depósito para detergente. Também inclui-se-lhe uma pistola para lanças de bayoneta e um kit de acessórios formado por uma lança de tubo regulável, um bico rotativo e uma escova de lavagem fixa. Ligação rápida.

Ref	Max. P	⚡	HZ	⚖️	📦
7100 1014	2.500 W	230 V	50 Hz	21 kg	445,20



LIMPIADORA ALTA PRESIÓN 210CC PISTOLA PROFESIONAL / NETTOYEUR HAUTE PRESSION 210CC PISTOLET PROFESIONNEL  
210CC PRESSURE WASHER WITH PROFESSIONAL GUN / IDROPULITRICE ALTA PRESSIONE 210CC PISTOLA PROFESSIONALE  
LAVADORA ALTA PRESSÃO 210CC PISTOLA PROFISSIONAL



**MOD. MICHIGAN**

**210 CC**

ES Pistola profesional.  
FR Pistolet professionnel.  
EN Professional trigger gun.  
IT Pistola professionale.  
PT Pistóla profissional.



ES 5 Puntas intercambiables con distintos tipos de chorro.  
FR 5 embouts interchangeables avec différents types de jet.  
EN 5 interchangeable nozzles with different pressure waterjet.  
IT 5 punte intercambiabili con diversi tipi di guetti.  
PT 5 pontas intercambiáveis com diferentes tipos de jato.

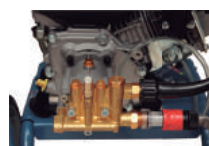

ES Bomba de latón.  
FR Pompe en laiton.  
EN Brass pump.  
IT Pompa in ottone.  
PT Bomba de latão.



ES Manguera autoaspirante de 3 m.  
FR Tuyau auto-aspirant de 3 m.  
EN 3m self-priming pump.  
IT Tubo flessibile auto aspirante di 3 m.  
PT Manguêira autoaspirante de 3m.

ES	Motor / Engine	<b>4 Tiempos / 4-stroke</b>
EN	Cilindrada / Displacement	<b>210 cc</b>
	Potencia máxima / Maximum power	<b>7,0 CV</b>
	Presión nominal / Nominal pressure	<b>186 bar</b>
	Presión máxima / Maximum pressure	<b>207 bar</b>
	Caudal / Flow rate	<b>600 l/h</b>
	Longitud manguera / Hose length	<b>8 m</b>
	Rango de temperatura de agua utilizable / Usable water temperature range	<b>0 - 45 °C</b>
	Presión máxima de entrada del agua / Maximum water inlet pressure	<b>7 bar (0,7 MPa)</b>
	Nivel de potencia sonora garantizada / Guaranteed sound power level	<b>109 dB</b>
	Peso / Weight	<b>39,7 kg</b>

ES Hidrolavadora con bomba refrigerada por agua con cabezal de latón y pistones de acero, avisador de falta de aceite en el motor sobre silentblocks al chasis. Motor aislado con antivibraciones de 7HP de 4 tiempos con válvulas en cabeza, pistola profesional reforzada con rosca 4 puntas de conexión rápida, manguera reforzada, chasis de acero con ruedas de transporte y bomba autoaspirante. Depósito de jabón incluido.

FR Nettoyeur haut pression avec pompe refroidie à l'eau avec tête en laiton et pistons en acier, avertisseur de manque d'huile dans le moteur sur le silentblocks au châssis. Moteur isolé avec anti vibrations de 7HP de 4 temps avec des valves sur la tête, pistolet professionnel renforcé avec filetage 4 pointes de connexion rapide, tuyau renforcé, châssis en acier avec roues de transport et pompe auto aspirante. Réservoir de savon inclus.

EN This pressure washer incorporates a water-cooled pump with a brass head and steel pistons. It also has a warning device for the oil shortage, located in the motor, on the silentblocks chassis. It consist of a 4-stroke insulated engine with 7HP anti-vibration, 4 valves on the head, a professional trigger gun reinforced with a thread for these 4 quick connection nozzles; a reinforced hose, a steel chassis with transport wheels and a self-priming pump. A soap tank is included.

IT Idropulitrice con una pompa raffreddata ad acqua e testata in ottone, pistoni in acciaio, avviso di mancanza di olio nel motore su supporto telaio silentblocks. Motore di 4 tempi isolato con antivibrazioni di 7HP, valvole in testa, pistola professionale rinforzata, filo con 4 punte di connessione rapida, tubo rinforzato, telaio in acciaio con ruote per il trasporto e pompa auto aspirante. Dispone di un serbatoio detergente.

PT Hidrolavadora com bomba refrigerada a água com cabeça de latão e pistões de aço, sinalizador de falta de óleo no motor com silenciadores no do chaci. Motor isolado com antivibração 7HP a 4 tempos, pistola profissional reforçada com rosca de conexão rápida de 4 pontos, mangueira reforçada, chassi de aço com rodas de transporte e bomba autoaspirante. Depósito de detergente.

Ref	Max. P	CC	kg	€
<b>7100 1015</b>	7,0 Cv	210 cc	39,7 kg	<b>683,45</b>



MOTOSIERRA MOD.ALASKA 25,4CC CADENA MINI ESPADA 10" / TRONÇONNEUSE "ALASKA" 25,4CC MINI GUIDE 10" AVEC CHAÎNE 25.4CC CHAINSAW "ALASKA" 10" MINI GUIDE BAR CHAIN / MOTOSEGA "ALASKA" 25,4CC CATENA MINI BARRA GUIDA 10" MOTOSERRA "ALASKA" 25,4CC CORRENTE MINI ESPADA 10"



MOD. ALASKA

25,4 CC  
10"



ES	Motor / Engine	2 tiempos / strokes
EN	Cilindrada / Displacement	25,4 cc
	Potencia máxima / Peak power	0,8 Kw / 1,10 Cv
	Régimen al ralentí / Idling	3.500 min <sup>-1</sup>
	Régimen máximo del motor / Maximum engine speed	11.000 min <sup>-1</sup>
	Combustible utilizado / Fuel used	Gasolina 40: aceite 1 = 2,5% / Petrol 40: oil 1 = 2.5%
	Consumo específico de la máquina a potencia máxima del motor / Specific fuel consumption for the machine's maximum power	580 g/kWh
	Tipo de Carburador / Type of carburetors	Diafragma / Diaphragm carburetor
	Tipo de engrase de cadena / Type of lubricating chain	Automático / Automatic
	Capacidad del depósito de combustible / Fuel tank capacity	230 cm <sup>3</sup>
	Capacidad del depósito de aceite de cadena / Chain oil tank capacity	160 cm <sup>3</sup>
	Longitud de barra / Guide bar length	10"
	Longitud de corte utilizable / Usable cut length	26 cm
	Paso de la cadena / Chain spacing	3/8" bajo perfil / 3/8" low profile
	Espesor de la cadena / Thickness of the chain	0,050"
	Número de eslabones / Number of cutters	40
	Tipo de barra / Type of guide bar	Punta piñon / Sprocket tip
	Nivel de potencia sonora media LwA / Average sound power level LwA	105,8 dB
	Nivel de potencia sonora garantizada LwA / Guaranteed sound power level LwA	108 dB
	Nivel de presión sonora media LpA / Average sound pressure level LpA	95,8 dB
	Nivel de vibración en la empuñadura delantera / Front handle vibration level	7,5 m/s <sup>2</sup>
	Nivel de vibración en la empuñadura trasera / Rear handle vibration level	8,7 m/s <sup>2</sup>
	Peso / Weight	3,8 kg

ES Cómoda y ligera motosierra, especial para poda. Su reducido tamaño permite realizar un trabajo rápido y eficaz cuando se trata de poda, incluso manejándola con una sola mano. Sus características la convierten en una herramienta ideal para la poda. Cuenta con cebador primer que ayuda al arranque en frío, sistema antivibración que reduce la fatiga, freno de cadena que actúa en caso de retroceso y engrase automático de cadena para un perfecto funcionamiento.

FR Scie à chaîne confortable et légère, particulièrement pour la taille. Sa petite taille vous permet d'effectuer un travail d'élagage rapide et efficace, même en la manipulant d'une seule main. Ses caractéristiques en font un outil de taille idéal. Il possède un premier amorce qui aide au démarrage à froid, un système anti-vibration qui réduit la fatigue, un frein de chaîne qui agit en cas de recul et une lubrification automatique de la chaîne pour un fonctionnement parfait.

EN Comfortably lightweight chainsaw, special for pruning. Despite of its compact size, it enables a rapid and efficient pruning, even if it is used with only one hand. Its features make it a perfect tool for pruning. That chainsaw incorporates a starter which supports the cold start, an antivibration system that reduces the fatigue, a chain brake which acts in case of setback or automatic chain lubrication for a perfect operation.

IT Motosega leggera e confortevole, speciale per fare la potatura. Nonostante le sue dimensioni ridotte, questa motosega consente fare la potatura rapida ed efficientemente, anche se usato con una sola mano. Le sue caratteristiche lo rendono ideale per la potatura. La macchina incorpora un dispositivo di avviamento primer che contribuisce all'avviamento a freddo, un sistema antivibrazione che riduce la stanchezza, un freno catena che interviene in caso di regressione e lubrificazione automatica della catena per il funzionamento ottimale.

PT Motosserra cómoda e leve, especial para a poda. O seu tamanho reduzido permite realizar um trabalho rápido e eficaz quando se trata de poda, inclusive manejando-a somente com uma mão. As suas características, convertem-na numa ferramenta ideal para a poda. Conta com um misturador primer que ajuda no arranque a frio, sistema anti-vibração que reduz a fadiga, travão de corrente que actua em caso de recuo e lubrificação automática da corrente para um perfeito funcionamento.

Ref	CC	Kw/Cv			
7100 1001	25,4	0,8 / 1,1	230 cm <sup>3</sup>	3,8 kg	239,40





MOTOSIERRA MOD.DAKOTA 53CC CADENA 0,325 18" ESPADA / TRONÇONNEUSE "DAKOTA" 53CC GUIDE 18" AVEC CHAÎNE 0,325 53 CC CHAINSAW "DAKOTA" 0.325" CHAIN 18" GUIDE BAR / MOTOSEGA "DAKOTA" 53CC CATENA 0,325" 18" BARRA GUIDA  
MOTOSERRA "DAKOTA" 53CC CORRENTE 0,325 18" ESPADA



MOD. DAKOTA

53 CC  
18"



ES	Motor / Engine	2 tiempos / strokes
EN	Cilindrada / Displacement	53 cc
	Potencia máxima / Peak power	2,2 Kw / 3,0 Cv
	Régimen al ralentí / Idling	3.000 min <sup>-1</sup>
	Régimen máximo del motor / Maximum engine speed	10.500 min <sup>-1</sup>
	Combustible utilizado / Fuel used	Gasolina 40: aceite 1 = 2,5% / Petrol 40: oil 1 = 2.5%
	Consumo específico de la máquina a potencia máxima del motor / Specific fuel consumption for the machine's maximum power	569 g/kWh
	Tipo de Carburador / Type of carburetors	Diafragma / Diaphragm carburetor
	Tipo de engrase de cadena / Type of lubricating chain	Automático / Automatic
	Capacidad del depósito de combustible / Fuel tank capacity	550 cm <sup>3</sup>
	Capacidad del depósito de aceite de cadena / Chain oil tank capacity	260 cm <sup>3</sup>
	Longitud de barra / Guide bar length	18"
	Longitud de corte utilizable / Usable cut length	45 cm
	Paso de la cadena / Chain spacing	0,325"
	Espesor de la cadena / Thickness of the chain	0,058"
	Dientes piñón de ataque / Driving pinion teeth	7
	Número de eslabones de cadena / Number of chain cutters	76
	Nivel de potencia sonora media LwA / Average sound power level LwA	111,20 dB
	Nivel de potencia sonora garantizada LwA / Guaranteed sound power level LwA	115 dB
	Nivel de presión sonora media LpA / Average sound pressure level LpA	91,20 dB
	Nivel de vibración en la empuñadura delantera / Front handle vibration level	15,11 m/s <sup>2</sup>
	Nivel de vibración en la empuñadura trasera / Rear handle vibration level	11,37 m/s <sup>2</sup>
	Peso / Weight	7,6 kg

ES Motosierra ideal para un usuario que necesita realizar todo tipo de cortes. Su espada de 18" permite derribar árboles de gran tamaño y tiene un peso adecuado para las tareas de troceo de troncos. Dispone de manillar ergonómico de alto agarre, cebador, y arrancador reforzado.

FR La tronçonneuse est idéale pour un utilisateur qui doit faire toutes sortes de coupes. Sa lame de 18" permet la démolition de gros arbres et dispose d'un poids approprié pour les travaux de taille. Dotée d'un corps ergonomique, d'un système d'amorce et de démarrage renforcé.

EN This chainsaw is perfect for those users who want to carry out every kind of cuts. Despite of its guide bar, it enables the felling of big tees and its weight is suitable for sawing logs. The chainsaw has an ergonomic high-grip handlebar, and a reinforced starter.

IT Questa motosega è perfetta per gli utilizzatori che vogliono eseguire qualsiasi tipo di taglio. Nonostante la sua barra guida, la motosega consente abbattere gli grandi alberi e il suo peso è idoneo a troncare i tronchi. La motosega ha un manubrio ergonomico ad alta presa, un dispositivo di avviamento e un aviatore rinforzato.

PT Motosserra ideal para um usuário que necessite de realizar todo o tipo de cortes. A sua barra guia de 18" permite derrubar árvores de grande porte e têm um peso adquado para as tarefas de cortar troncos. Dispõe de guiador ergonómico de grande agarre, misturador e arrancador reforçado.

Ref	CC	Kw/Cv			
7100 1002	53	2,2 / 3,0	550 cm <sup>3</sup>	7,6 kg	248,50

**ACEITE ESPECIAL CADENAS MOTOSIERRA / HUILE SPÉCIALE POUR LA CHAÎNE DE TRONÇONNEUSE / CHAINSAW OIL SPECIAL FOR CHAINS  
OLIO SPECIALE PER CATENA MOTOSEGA / ÓLEO ESPECIAL CORRENTES MOTOSERRA**

- ES **Resistente a la oxidación.**
- FR **Résistant à l'oxydation.**
- EN **Resistant to oxidation.**
- IT **Resistente all'ossidazione.**
- PT **Resistente á oxidação.**

- ES Evita el desgaste de la cadena y eslabones. Disminuye la pérdida de aceite por goteo. Aceite especialmente formulado para el engrase de cadenas de motosierra altamente adherente a la superficie a lubricar.
- FR Évite l'usure des chaînes et des maillons. Réduit la perte d'huile par égouttement. Huile spécialement formulée pour la lubrification des chaînes de tronçonneuses très adhérentes à la surface à lubrifier.
- EN Prevents any wear on chains and links. Reduce the oil drip leaks. This oil is specially formulated for the chain saw lubrication which is highly adherent to the surface of the chainsaw to lubricate.
- IT Evita l'usura dei catene e anelli. Riduce la perdita di olio gocciolante. Il olio appositamente formulato per la lubrificazione della catena della motosega ad alta aderenza alla superficie per lubrificare.
- PT Evita o desgaste da corrente e do elo. Diminui a perda de óleo por gotejamento. Óleo especialmente formulado para a lubrificação de correntes de motosserra, altamente aderente á superfície a lubrificar.

Ref				
<b>1550 2024</b>	5 L	1	5	<b>17,01</b>
<b>1550 2025</b>	1 L	1	18	<b>5,12</b>

**CADENA MOTOSIERRA / CHAÎNE DU TRONÇONNEUSE / CHAIN SAW / CATENA DA MOTOSEGA / CORRENTE MOTOSERRA**
**Mod. Alaska**

- ES Cadena para motosierra Mod. Alaska de diente redondo, bajo perfil, alto rendimiento y baja vibración para cortes limpios y continuados.
- FR Chaîne de ronçonneuse Mod. Alaska dent ronde, profil bas, haute performance et faible vibration pour des coupes nettes et continues.
- EN Chain designed for chainsaw Mod. Alaska. It is composed by round teeth low profile, high performance, and low vibration levels for clear and continuous cuttings.
- IT Catena da motosega Mod. Alaska con denti arrotondati, basso profilo, ad alte prestazioni e livelli di vibrazioni base al fine di tagliare in modo pulito e continuo.
- PT Corrente de motosserra Mod. Alaska de dentes redondos, baixo perfil, alto rendimento e baixa vibração para cortes limpos e continuados.

Ref		Espesor			
<b>7100 1001.16</b>	3/8 Bajo Perfil	0,050" / 1,3mm	40	Redondo	<b>16,35</b>

**Mod. Dakota**

- ES Cadena para motosierra Mod. Dakota de diente redondo, con alto rendimiento y baja vibración para cortes rápidos y uniformes.
- FR Chaîne de tronçonneuse à dents rondes Mod Dakota, haute performance et faible vibration pour des coupes rapides et uniformes.
- EN Chain designed for chainsaw Mod. Alaska. It is composed by round teeth of low profile, high performance, and low vibration levels for fast and uniform cuttings.
- IT Catena da motosega Mod. Alaska con denti arrotondati, basso profilo, ad alte prestazioni e livelli di vibrazioni base al fine di tagliare in modo rapido e uniforme.
- PT Corrente para motosserra Mod. Dakota de dentes redondos, com alto rendimento e baixa vibração para cortes rápidos e uniformes.

Ref		Espesor			
<b>7100 1002.16</b>	0,325"	0,058" / 1,5mm	72	Redondo	<b>26,90</b>

**ROLLO CADENA MOTOSIERRA / ROULEAU DE CHAÎNE A TRONÇONNEUSE / CHAIN LINK SAW ROLL FOR CHAINSAW  
ROTOLO PER CATENA MOTOSEGA / ROTOLO DE CORRENTES DE MOTOSSERRA**

- \* **Cada rollo incluye 30 empalmes.**
- \* **Each roll includes 30 chain connectors.**

**Mod. Alaska  
Mod. Dakota**

- ES Rollos de cadena para motosierra de diente redondo, de alto rendimiento y baja vibración para cortes rápidos y uniformes.
- FR Rouleaux de chaîne pour tronçonneuse à dent ronde, haute performance et faible vibration pour des coupes rapides et uniformes.
- EN Chain saw roll composed by round teeth of high performance and low vibration leves intended for fast and uniform cuttings.
- IT Catena da motosega con denti arrotondati, basso profilo, ad alte prestazioni e livelli di vibrazioni base al fine di tagliare in modo rapido e uniforme.
- PT Rolos de correntes para motosserra de dentes redondos, de alto rendimento y baixa vibração para cortes rápidos e uniformes.

Ref		Espesor				
<b>7100 1003</b>	3/8 Bajo Perfil	0,050" / 1,3mm	1635	Redondo	30,5 m	<b>389,5</b>
<b>7100 1004</b>	0,325"	0,058" / 1,5mm	1840	Redondo	30,5 m	<b>471,5</b>
<b>7100 1006</b>	3/8"	0,050" / 1,3mm	1635	Redondo	30,5 m	<b>471,5</b>
<b>7100 1007</b>	3/8"	0,058" / 1,5mm	1635	Redondo	30,5 m	<b>471,5</b>
<b>7100 1008</b>	0,325"	0,050" / 1,3mm	1840	Redondo	30,5 m	<b>471,5</b>



SOLDADOR INVERTER ELÉCTRICO MMA 120 A / POSTE À SOUDAGE INVERTER 120 A / ARC INVERTER WELDING MACHINE 120 A  
SALDATRICE INVERTER ARC 120 A / MÁQUINA DE SOLDAR INVERTER ELÉTRICO ARCO 120 A



120 A



ES	Voltaje nominal de entrada / Nominal input voltage	AC220V ±10%
EN	Corriente nominal de entrada / Nominal input current	17 A
	Capacidad nominal de entrada / Nominal input capacity	4.79 kVA
	Corriente/voltaje de salida nominal / Output current/voltage	120 A / 24.8 V
	Rango corriente de salida / Rated output current	20~120 A
	Sin tensión de carga (V) / Without charge voltage (V)	59V
	Eficiencia / Efficiency	85%
	Factor de potencia / Power factor	0,73
	Clase de protección / Class of protection	IP21S
	Clase de aislamiento / Insulation class	F
	Ciclo de trabajo nominal / Rated duty cycle	40% (40°C)
	Tamaño de electrodo estándar / Size of standard electrode	1.2~3.2 mm
	Medidas / Dimensions	285*130*235 mm
	Peso / Weight	3,88 kg
	Funciones / Functions	Arranque en caliente, función electrodo antiadherente, protección término.

ES Circuito de medio puente con tecnología avanzada de inverter igt, salida de CC, alta eficiencia, ahorro de energía. Con indicador de O.C y O.H. protección y arranque en caliente. Portátil y ligero, fácil de transportar. Uso especial para operaciones en altura, agrícolas, bricolaje, tanto en interiores como exteriores.

FR Circuit de demi-pont avec technologie avancée d'inverseur igt, sortie CC, haute efficacité, économie d'énergie. Avec indicateur O.C et O.H. protection et démarrage à chaud. Portable et léger, facile à transporter. Utilisation spéciale pour les opérations en hauteur, agricole, bricolage, à l'intérieur comme à l'extérieur.

EN Half bridge circuit with advanced technology IGBT inverter, DC, highly efficient, and energy savings. It has an OC & OH protection indicator and hot-start. Portable, lightweight and easy to transport. It is suitable for a special use for work at heights, agricultural, and DIY operations in both indoors and outdoors.

IT Circuiti del mezzo ponte con Inverter IGBT di tecnologia avanzata e uscita C.C., ad elevata efficienza e risparmi energetici. Con indicatore di protezione OC e OH e hot start. Portatile, leggera e di trasporto facile. Può essere usato per operare ad altezze, agronomiche e bricolage sia in ambienti interni che esterni.

PT Circuito de meia ponte com inverter IGBT de tecnologia avançada, saída DC, alta eficiência, economia de energia. Com indicador de proteção O.C. e O.H.e arranque em quente. Uso especial para trabalhos em altura, trabalhos agrícolas, bricolage, tanto em interiores como exteriores.

Ref

0900 5101



141,75



SOLDADOR INVERTER ELÉCTRICO MMA 200A / POSTE À SOUDAGE INVERTER MMA 200A / ARC INVERTER WELDING MACHINE MMA 200A  
SALDATRICE INVERTER MMA 200A / MÁQUINA DE SOLDAR INVERTER ELÉTRICA MMA 200A



200 A



ES	Voltaje nominal de entrada / Nominal input voltage	AC220V ±10%
EN	Corriente nominal de entrada / Nominal input current	33A
	Capacidad nominal de entrada / Nominal input capacity	9 KVA
	Corriente/voltaje de salida nominal / Output current/voltage	200A/28V
	Rango corriente de salida / Rated output current	20~200 A
	Sin tensión de carga (V)	95V
	Eficiencia / Efficiency	85%
	Factor de potencia / Power factor	0,73
	Clase de protección / Class of protection	IP21S
	Clase de aislamiento / Insulation class	F
	Ciclo de trabajo nominal / Rated duty cycle	60% (40°C)
	Tamaño de electrodo estándar / Size of standard electrode	1.2~5.0mm
	Tamaño de electrodo Celulosa / Size of cellulose electrode	E6010/E6011/E7018 1.2~4.0 mm
	Medidas / Dimensions	370*150*275 mm
	Peso / Weight	6,2 kg
	Funciones / Functions	Arranque en caliente, función electrodo antiadherente, VRD, TIG LIFT, protección térmica.

ES Circuito de puente completo con tecnología avanzada de inversor igt, salida de CC, alta eficiencia, ahorro de energía. Potencia de salida estable, arco continuo y escasas salpicaduras. Bajo desgaste de sus componentes y larga vida útil. Con funciones de ARRANQUE CALIENTE, LIFT TIG, VRD, ARC-FORCE y ANTI-STICK reguladas manualmente. Capaz de soldar en la mayoría de las industrias y todos los campos de soldadura de precisión, como también la soldadura de placas delgadas, etc.

FR Circuit de pont complet avec technologie avancée d'inverseur igt, sortie CC, haute efficacité, économie d'énergie. Puissance de sortie stable, arc continu et peu de projections. Faible usure des pièces et longue durée de vie. Avec les fonctions DEMARRAGE A CHAUD, LIFT TIG, VRD, ARC-FORCE et ANTI-STICK réglées manuellement. Possibilités de souder dans la plupart des industries et dans tous les domaines qui demandent une soudure de précision, soudure de plaques fines, etc.

EN Full bridge circuit with advanced technology IGBT inverter, DC output, highly efficient, and energy savings. Stable power output, continuous wire welding arc, and few splashes. Low-wear in all its components and long service life. With HOT START, TIG LIFT, VRD, ARC-FORCE & ANTI-STICK functions manually controlled. It's capable of welding in most industries and in any precision welding fields as well as thin plates, etc.

IT Circuito di ponte intero con Inverter IGBT di tecnologia avanzata e uscita C.C., ad elevata efficienza e risparmi energetici. Potenza utile stabile, torcia a filo continuo e qualche spruzzi. Bassa usura in tutte le sue componenti e lunga durata di vita. Dispositivi HOT START, TIG LIFT, VRD, ARC-FORCE e ANTI-STIC controllate manualmente. Capace di saldare nella maggior parte dei settori industriali e ogni campo della saldatura di precisione, nonché la saldatura piastre sottili.

PT Circuito de ponte completo com Inverter IGBT de tecnologia avançada, saída em DC, com poupança de energia. Potência de saída estável, arco continuo e escassas salpicaduras. Baixo desgaste dos seus componentes e longa vida útil. Com funções de ARRANQUE QUENTE, TIG LIFT, VRD, ARC-FORCE e ANTI-STICK reguladas manualmente. Capaz de soldar na maioria das industrias e em todos os campos de soldadura de precisão, como também a soldadura de chapas de baixa espessura.

Ref	346,50
0900 5121	



SOLDADOR INVERTER ELÉCTRICO MMA 160A/TIG 200A / POSTE À SOUDAGE INVERTER 160A/TIG 200A / ARC INVERTER WELDING MACHINE 160A/TIG 200  
ASALDATRICE INVERTER 160A/TIG 200A / MÁQUINA DE SOLDAR INVERTER ELÉTRICA 160A/TIG 200A

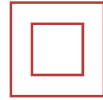

IP 21S

MMA: 120 A  
TIG: 200 A



ES	Voltaje nominal de entrada / Nominal input voltage	AC220V ±15%
EN	Corriente nominal de entrada / Nominal input current	MMA: 35.8A TIG: 36.4A
	Capacidad nominal de entrada / Nominal input capacity	MMA: 7.8 kVA TIG: 200/18
	Corriente/voltaje de salida nominal / Output current/voltage	MMA:160A/26.4V TIG: 10-200A
	Sin tensión de carga (V) / Without charge voltage (V)	65V
	Eficiencia / Efficiency	85%
	Factor de potencia (cos Φ) / Power factor (cos Φ)	0,73
	Clase de protección / Class of protection	IP21S
	Clase de aislamiento / Insulation class	F
	Ciclo de trabajo nominal / Rated duty cycle	40% (40°C)
	Tamaño de electrodo estándar / Size of standard electrode	1.2~4.0 mm
	Tamaño electrodo tungsteno / Size of tungsten electrode	1.6/2.4/3.2 mm
	Medidas / Dimensions	380*155*280 mm
	Peso / Weight	8,2 kg
	Funciones / Functions	Inicio HF, arco sin contacto, protección término, TIG / MMA

ES Inverter de soldar TIG / MMA, o solo TIG. Portátil y ligero, fácil de transportar. Tecnología avanzada de inversor IGBT con ahorro de energía. Soldadura TIG con electrodo de tungsteno fundido con método de inicio de arco de HF sin contacto que evita quemaduras en piezas delgadas. El gas después del flujo puede igualarse entre 1 y 10 segundos lo que ayuda a perfeccionar la soldadura. Con indicador de O.C y O.H. protección que prolonga la vida del inverter. Capaz de soldar acero inoxidable, metales no ferrosos, metales aleados de fácil oscilación y otras aleaciones.

FR Inverseur de soudure TIG / MMA, ou uniquement TIG. Portable et léger, facile à transporter. Technologie avancée d'inverseur IGBT avec économies d'énergie. Soudage TIG avec électrode de tungstène fondu avec méthode de démarrage à l'arc HF sans contact qui empêche les brûlures pour les pièces fines. Le gaz après le flux peut être égalisé entre 1 et 10 secondes ce qui contribue à améliorer la soudure. Avec indicateur O.C et O.H. de protection qui prolonge la durée de vie de l'inverseur. Possibilité de souder l'acier inoxydable, les métaux non ferreux, les alliages à oscillation facile et d'autres alliages.

EN TIG/MMA or just TIG Inverter welding process. Portable, lightweight and easy to transport. Inverter IGBT with advanced technology and energy savings. TIG welding with cast tungsten electrode, a HF arc method of starting without contact prevents dangerous burns on thin parts. After the flux, the gas can be equalised approximately in 1 and 10 seconds, which helps refine the welding. It has an OC & OH protection indicator that prolongs the inverter's life. It's capable of welding stainless steel, non-ferrous materials, easy fluctuation alloy materials and other alloys.

IT Saldatrice Inverter TIG/MMA o solo TIG. Portatile, leggera e di trasporto facile. Inverter IGBT di tecnologia avanzata con risparmi energetici. La saldatura TIG con elettrodo di tungsteno fuso, un metodo di avviamento ad arco HF senza contatto previene pericolose ustioni su parti sottili. Dopo il flusso, il gas può essere equalizzato approssimativamente in 1 e 10 secondi, il che aiuta a perfezionare la saldatura. Con indicatore di protezione OC e OH che prolunghi la vita del Inverter. Capace di saldare acciaio inossidabile, materiali non ferrosi, materiali in lega di facile fluttuazione e altre leghe.

PT Inverter de soldar TIG /MMA, ou só TIG. Portátil e leve, fácil de transportar. Tecnologia avançada de inversor IGBT com poupança de energia. Soldadura TIG com electrodo de tungsténio de fundição com método de início de arco de HF sem contacto que evita queimaduras em peças de baixa espessura. O gás depois do fluxo pode regular-se entre 1 e 10 segundos, o que ajuda a uma soldadura mais perfeita. Com indicador de O.C. e O.H. proporciona proteção que prolonga a vida do inverter. Capaz de soldar aço inoxidável, metais não ferrosos e outras ligas

Ref

0900 5141



531,00





0900 5101



KIT PORTAELECTRODOS CON CABLE / KIT PINCE PORTE ÉLECTRODES AVEC CÂBLE  
KIT WELDING ELECTRODE HOLDER WITH CABLE / KIT PINZA PORTA ELETTRODO CON CAVO  
KIT PORTA-ELÉTRODOS COM CABO

Ref	↔	A	📦	📦
0900 5101.01	2 m	200 Amp	1	11,32



KIT PINZA MASA CON CABLE / KIT DE PINCE MASSE AVEC CABLE  
KIT WELDING EARTH CLAMP WITH CABLE / KIT DI MORSETTO DI MASSA CON CAVO  
KIT ALICATE DE MASA COM CABO

Ref	↔	A	📦	📦
0900 5101.02	1,2 m	200 Amp	1	5,61



PINZA PORTAELECTRODOS / PINCE ÉLECTRODES / WELDING HOLDER  
PINZA PORTA ELETTRODO / PINÇA PORTA-ELÉTRODOS

Ref	A	📦	📦
0900 5101.03	200 Amp	1	3,45



PINZA DE MASA / PINCE PORTE ÉLECTRODES / WELDING ELECTRODE HOLDER  
PINZA PORTA ELETTRODO / ALICATE DE MASA 200AMP

Ref	A	📦	📦
0900 5101.04	200 Amp	1	1,29



CONECTOR MACHO/HEMBRA / CONNECTEUR MALE/FEMELLE  
MALE/FEMALE WELDING CABLE CONNECTOR / CONNETTORE CAVO MASCHIO/FEMMINA  
CONECTO MACHO/FEMEA

Ref	MODEL	📦	📦
0900 5101.05	Macho	1	1,38
0900 5101.06	Hembra	1	1,38

0900 5121



KIT PORTAELECTRODOS CON CABLE / KIT PINCE PORTE ÉLECTRODES AVEC CÂBLE  
KIT WELDING ELECTRODE HOLDER WITH CABLE / KIT PINZA PORTA ELETTRODO CON CAVO  
/ KIT PORTA-ELÉTRODOS COM CABO

Ref	↔	A	📦	📦
0900 5121.01	3 m	300 Amp	1	20,70



PINZA PORTAELECTRODOS / PINCE ÉLECTRODES / WELDING HOLDER  
PINZA PORTA ELETTRODO / PINÇA PORTA-ELÉTRODOS

Ref	A	📦	📦
0900 5121.02	300 Amp	1	4,23



PINZA DE MASA / PINCE PORTE ÉLECTRODES / WELDING ELECTRODE HOLDER  
PINZA PORTA ELETTRODO / ALICATE DE MASA

Ref	A	📦	📦
0900 5121.03	200 Amp	1	2,99



CONECTOR MACHO/HEMBRA / CONNECTEUR MALE/FEMELLE  
MALE/FEMALE WELDING CABLE CONNECTOR / CONNETTORE CAVO MASCHIO/FEMMINA  
CONECTO MACHO/FEMEA

Ref	MODEL	📦	📦
0900 5121.04	Macho	1	3,45
0900 5121.05	Hembra	1	3,45

0900 5141



KIT PORTAELECTRODOS CON CABLE / KIT PINCE PORTE ÉLECTRODES AVEC CÂBLE  
KIT WELDING ELECTRODE HOLDER WITH CABLE / KIT PINZA PORTA ELETTRODO  
CON CAVO / KIT PORTA-ELÉTRODOS COM CABO

Ref	↔	A	📦	📦
0900 5141.01	1,2 m	200 Amp	1	6,58



KIT SOLDADURA CON ANTORCHA TIG / KIT DE SOUDURE AVEC CHALUMEAU TIG  
KIT WELDING WITH TIG TORCH / KIT SALDATURA CON TORCIA TIG  
KIT SOLDADURA COM TOCHA TIG

Ref	↔	PACK	📦	📦
0900 5141.02	4 m	TIG + CABLE	1	82,80



COLLAR ANTORCHA TIG SOLDADURA / TORCHE TIG / TIG WELDING TORCH  
TORCIA TIG / PINÇA TIG

Ref	📦	📦
0900 5141.03	1	1,38



CUERPO COLLARIN ANTORCHA TIG / TORCHE TIG COMPLET  
COMPLETE TIG WELDING TORCH / TORCIA TIG COMPLETA  
CORPO FIXADOR DA PINÇA TIG

Ref	📦	📦
0900 5141.04	1	1,84



BOQUILLA CERAMICA ANTORCHA TIG / BUSE CÉRAMIQUE POUR TORCHE TIG  
GAS LENS CUP FOR TIG WELDING TORCH / UGELLO IN CERAMICA PER TORCIA TIG  
DIFUSOR DE CERÂMICA TOCHA TIG

Ref	📦	📦
0900 5141.05	1	1,15





ELECTRODOS DE RUTILO E-6013 / ÉLECTRODES DE RUTILE E-6013 / E-6013 RUTILE TYPE ELECTRODES  
ELETTRDI RUTILICI E-6013 / ELÉTRODOS TIPO RUTILE E-6013



E-6013

Precio x caja  
Price x box

Ref	∅	PACK			
0900 5200	2 mm	6 cajas/boxes	175 pcs		22,39
0900 5250	2,5 mm	6 cajas/boxes	145 pcs		20,20
0900 5325	3,25 mm	6 cajas/boxes	95 pcs		19,45
0900 5400	4 mm	6 cajas/boxes	65 pcs		19,45

ES Aplicación general en todas posiciones. Recomendado para aceros estructurales limpios.  
FR D'application générale dans toutes les positions. Il est recommandé par aciers de construction nettoyés.  
EN General applicaton to all positions. It is recommended for structural cleaned steels.  
IT Applicazione generale per tute le posizioni. È raccomandato per acciaio strutturale puliti.  
PT Aplicação geral em todas as posições. Recomendado para aços estruturales limpos.

Precio x blíster  
Price x blister

Ref	∅	↔				
0900 5220	2 mm	300 mm	40 pcs	45 bl	1	9,45
0900 5225	2,5 mm	350 mm	30 pcs	45 bl	1	9,45
0900 5232	3,25 mm	350 mm	20 pcs	45 bl	1	9,45

BLÍSTER ELECTRODOS INOX E-316L / BLISTER ELECTRODES INOX E-316L / BLISTER OF ST. STEEL ELECTRODES E-316L  
BLISTER ELETTRDI INOX E-316L / BLÍSTER ELECTRODOS INOX E-316L



E-316L

INOX

ES Aplicación general en todas posiciones. Recomendado para aceros estructurales limpios.  
FR D'application générale dans toutes les positions. Il est recommandé par aciers de construction nettoyés.  
EN General applicaton to all positions. It is recommended for structural cleaned steels.  
IT Applicazione generale per tute le posizioni. È raccomandato per acciaio strutturale puliti.  
PT Aplicação geral em todas as posições. Recomendado para aços estruturales limpos.

Precio x blíster  
Price x blister

Ref	∅	↔				
0900 5316	2,5 mm	350 mm	10 pcs	45 bl	1	13,95





	ES	FR	EN	IT	PT
<b>Ref</b>	Referencia	Référence	Reference	Riferimento	Referência
	Capacidad depósito	Capacité	Capacity	Capacità	Depósito
	Precio	Prix	Price	Prezzo	Preço
	Colores	Couleur	Colour	Colore	Cores
	Voltaje	Voltage	Voltage	Voltaggio	Voltagem
<b>Nm<sub>MAX</sub></b>	Apriete máximo	Serrage maximum	Maximum torque	Apertura massimo	Aperto máximo
	Tiempo de carga	Temps de charge	Charge time	Tempo de carica	Tempo de carga
<b>Ø MAX</b>	Diámetro máximo	Diamètre maximum	Maximum diameter	Diametro massimo	Diâmetro máximo
	Percutor	Percuteur	Hammer drill	Percussore	Percutor
	Diámetro del disco	Diamètre disque	Disc diameter	Disco diámetro	Diametro disco
<b>MODEL</b>	Modelo	Modèle	Model	Modello	Modelo
	Rosca	Filetage	Thread	Rivettatura	Rosca
<b>Lm</b>	Lúmenes	Lumens	Lumens	Lumen	Lumens
	Presión	Pression	Pressure	Pressione	Pressão
	Longitud cortasetos	Longueur taille-haie	Hedge trimmer length	Lunghezza tagliasiepi	Comprimento do corta-sebes
	Ancho cortacésped	Largeur tondeuse à gazon	Lawn mower width	Larghezza tagliasiepi	Largura cortador de relva
<b>rpm</b>	Revoluciones por minuto	Rotations par minute	Revolutions per minute	Giri per minuto	Rotações por minuto
	Diámetro de hilo	Diamètre de fil	Thread diameter	Diametro filetto	Diâmetro do fio
	Medidas telescopio	mesures télescope	Telescope measures	Misure telescopio	medidas telescópio
	Duración de batería	Durée batterie	Battery life	Durata batteria	Duração bateria
	Medidas corte	Mesures de coupe	Cutting measures	Misure taglio	Medidas corte
	Separación dientes	Séparation dents	Teeth separation	Distanza denti	Separação dentes
	Rango altura de corte	Rang hauteur de coupe	Cutting height range	Range altezza del taglio	Escala altura de corte
	Revoluciones por minuto	Rotations par minute	Revolutions per minute	Giri al minuto	Revoluções por minuto
	Descripción	Description	Description	Descrizione	Descrição
	Medidas	Mesures	Measurements	Misure	Medidas
	Duración batería	Durée de vie de la batterie	Battery life	Durata della batteria	Duração de bateria
	Tiempo de carga	Temps de charge	Charging time	Tempo di ricarica	Tempo de carga
	Profundidad corte 90°	Profondeur de coupe 90°	Cutting Width 90°	Larghezza di taglio 90°	Profundidade do corte a 90°
	Profundidad corte 45°	Profondeur de coupe 45°	Cutting Width 45°	Larghezza di taglio 45°	Profundidade de corte a 45°
	Ángulo	Angle	Angle	Angolo	Ângulo
	Espesor corte máximo de acero	Épaisseur maximale de coupe de l'acier	Max. steel cutting thickness	Spessore di taglio max. di acciaio	Espessura de corte máxima no aço
	Espesor corte máximo de madera	Épaisseur maximale de coupe de bois	Max. wood cutting thickness	Spessore di taglio max. di legno	Espessura de corte máximo na madeira
	Diámetro	Diamètre	Diameter	Diametro	Diâmetro
	Peso	Poids	Weight	Peso	Peso
	Golpes	Coups	Hits	Forza dell' impatto	Golpes
<b>Max. P</b>	Potencia máx.	Puissance Maxi	Max. power	Max. potenza	Potência Max
<b>CC</b>	Centímetros Cúbicos	Centimètres cubes	Cubic centimetres	Centimetri cubi	Centímetros Cúbicos
<b>Kw</b>	Kilovatios	Kilowatts	Kilowatt	Kilowatt	Kilowatts
<b>Kw/Cv</b>	Kilovatios/Caballos de potencia	Kilowatts/Chevaux de puissance	Kilowatt/ Horsepower	Kilowatt/Cavalli	Kilowatts/ potência de cavalos
	Blíster	Blister	Blister	Blister	Blister
	Eslabones	Liens	Links	Anelli	Elo
<b>HZ</b>	Hercios	Hertz	Hertz	Hertz	Hertz
	Contenido	Contenu	Contains	Contenuto	Inclui
	Unidad mínima de venta	Nombre d' unités mini-mun de vente	Minimum sale unit	Quantitativo minimo di vendita	Unidade mínima de venda
	Longitud	Longueur	Length	Lunghezza	Comprimento
	Packing	Conditionnement	Packing	Imballo	Embalagem





● cofan







# ÍNDICE / INDEX / CONTENTS

## INDICE / ÍNDICE



**58**

ESCALERAS / ECHELLE / LADDER  
SCALA / ESCADA



**87**

PUNTAS DE ATORNILLAR / EMBOUTS POR VISSEUSES  
SCREW BITS / PUNTE PER AVVITATORI  
BIT'S PARA PARAFUSAR



**61**

ESTANTERÍAS / ETAGÈRES / SHELVING  
SCAFFALI / ESTANTES



**93**

DESTORNILLADORES / TOURNEVIS / SCREWDRIVERS  
CACCIAVITI / CHAVES DE FENDAS



**63**

CARRETIILLAS / DIABLE PLIANTS / HAND TRUCKS  
CARRELLI / CARROS



**107**

BUSCAPOLOS / TESTEUR DE COURANT  
VOLTAGE TESTER / CERCAFASE / BUSCA-PÓLOS



**64**

EQUIPAMIENTO TALLER ESPECIALIZADO  
AUTILS ATELIEER SPECIALISE  
SPECIAL WORK EQUIPMENT  
ATTREZZATURA SPECIALE DA LAVORO  
EQUIPAMENTO ESPECIALIZADO PARA OFICINAS



**108**

ALICATES / PINCE A SERTIR  
PLIERS / PINZE / ALICATES



**83**

JUEGOS DE HERRAMIENTAS / KITS D'OUTILS À MAIN  
HAND TOOL KITS / KIT STRUMENTI A MANO  
JOGOS DE FERRAMENTAS



**117**

TENAZAS / TENAILLE / PINCERS  
TENAGLIE / TENAZES



**120**

TIJERAS / CISAILLES / SCISSORS  
FORBICI / TESOURAS



**135**

MARTILLOS / MARTEAUX / HAMMERS  
MARTELLI / MARTELOS



**122**

HERRAMIENTAS DE CORTE / OUTILLAGE DE COUPE  
CUTTING TOOLS / ATTREZZI DA TAGLIO  
FERRAMENTA DE CORTE



**138**

LLAVES / CLÉS / WRENCHES  
CHIAVI / CHAVES



**127**

CÚTTERS Y NAVAJAS / CUTTERS ET COUTEAUX  
KNIVES & PENKNIVES / TAGLIERINI E COLTELLI  
ESTILETES E CANIVETES



**147**

LLAVES DE VASO / DOUILLES / SOCKETS  
BRUGOLE / SOQUETES



**130**

GRANETES Y BOTADORES / POINCONS ET POUSSOIRS  
CENTRE & PIN PUNCHES / BULINI E PUNZONI  
PUNÇÕES E PERFURADORES



**159**

LLAVES DE IMPACTO / DOUILLES A CHOC  
IMPACT SPANNERS / CHIAVI A PERCUSSIONE  
CHAVES DE IMPACTO



**133**

TORNILLOS DE BANCO / ETAU A MORS / BENCH VICES  
MORSE DA BANCO / TORNO DE BANCADA



**161**

BOCAS DE IMPACTO / DOUILLES A CHOC  
IMPACT SOCKETS / BUSSOLE A PERCUSSIONE  
SOQUETES DE IMPACTO



**134**

EXTRACTORES / EXTRACTEUR / EXTRACTORS  
ESTRATTORI / EXTRATORES



**169**

LLAVES ALLEN Y TORX / CLÉ ALLEN ET TORX  
ALLEN & TORX WRENCHES / CHIAVI ALLEN E TORX  
CHAVES ALLEN E TORX



**173**

LLAVES INGLESAS / CLÉS ANGLAISES  
ADJUSTABLE SPANNERS / CHIAVI INGLES  
CHAVE AJUSTÁVEL



**193**

PALETAS DE CONSTRUCCIÓN / TRUELLES / BRICKLAYERS  
CAZZUOLE / COLHERES PARA CONSTRUÇÃO



**175**

HERRAMIENTAS FONTANERÍA / OUTILLAGE PLOMBERIE  
PLUMBING TOOLS / UTENSILI IDRAULICI  
FERRAMENTAS DE CANALIZAÇÃO



**201**

PALAS / PELLAS / SHOVELS  
PALE / PÁS



**184**

LLAVES PARA RUEDAS / CLÉS POUR ROUES  
WHEEL WRENCHES / CHIAVI RUOTA  
CHAVES PARA RODAS



**202**

HACHAS / HACHES / AXES  
ASCE / MACHADOS



**185**

SARGENTOS Y FORMONES  
SERRE-JOINT ET CISEAUX À BOIS  
CLAMPS AND FIRMER CHISEL / MORSETTI E CESELLI  
GRAMPOS E FORMÕES



**203**

AZADAS / HOUES / HOES  
ZAPPE / ENXADAS



**186**

LIMAS / LIMES / FILES  
LIMES / LIMAS



**208**

CAVAHOYOS DE ACERO / CREUSE-TROUS ACIER  
STEEL POST HOLE DIGGERS / SCAVABUCHI IN ACCIAIO  
CAVADEIRA DE AÇO



**192**

CONSTRUCCIÓN / CONSTRUCTION / CONSTRUCTION  
CONSTRUZIONI / CONSTRUÇÃO



**208**

CINCELES Y CORTAFRÍOS / BURINS ET CISEAUX DE MACONS  
COLD CHISELS & CHISELS / SCALPELLI E TAGLIA-GHIACCIO  
CINZÉIS E CORTA-FRIOS



**210**

MEDICIÓN Y NIVELACIÓN / MESURES ET NIVEAUX  
MEASUREMENT / METRI E LIVELLE  
MEDIÇÃO E NIVELAMENTO



**233**

GRAPADORAS / AGRAFEUSE / STAPLER  
PINZATRICE / AGRAFADOR



**218**

MECÁNICA-SOLDADORES / MÉCANICIEN-SOUDEURS  
MECHANICS-SOLDERING IRONS  
MECCANICA-SALDATORI / MECÂNICA-SOLDADURA



**236**

TERMOFUSIBLE / THERMOFUSIBLE / THEMOFUSE  
TERMOCOLLANTE / TERMO-FUSÍVEL



**219**

CEPILLOS / PINCEAUX / BRUSHES  
SPAZZOLE / ESCOVIAS

**i**

**238**

GLOSARIO / GLASSAIRE / GLOSSARY  
GLOSSARIO / GLOSSÁRIO



**224**

MOPAS LIMPIADORAS / BALAIS MICROFIBRES  
MOPS / MOCIO INDUSTRIALE / MOPAS PARA LIMPAR



**225**

RUEDAS / ROUE / TYRE  
RUOTA / RODA



**231**

RUEDA CARRETILLA / ROUE BROUETTE CHANTIER  
CONSTRUCTION TYRE / RUOTA PER CARRELLO  
RODA CARRINHO DE MÃO CONSTRUÇÃO



ESCALERA ALUMINIO / ECHELLE ALUMINIUM / ALUMINIUM LADDER / SCALA IN ALLUMINIO / ESCADA DE ALUMÍNIO



**EN 131  
150 Kg MAX**

**SIN BARRA ESTABILIZADORA / WITHOUT STABILISER BAR**

Ref	H	St	kg	Box	Price
0940 1000	2,00 m	7	4,00 kg	1	<b>69,69</b>
0940 1001	2,50 m	9	4,50 kg	1	<b>84,35</b>

**CON BARRA ESTABILIZADORA / WITH STABILISER BAR**

Ref	H	St	kg	Box	Price
0940 1002	3,00 m	11	5,50 kg	1	<b>116,25</b>
0940 1003	3,50 m	13	6,50 kg	1	<b>142,50</b>
0940 1004	4,00 m	15	7,50 kg	1	<b>165,40</b>

ESCALERA ALUMINIO DOBLE / ECHELLE ALUMINIUM DOUBLE / DOUBLE ALUMINIUM LADDER  
SCALA DOPPIA IN ALLUMINIO / ESCADA DE ALUMÍNIO DUPLA



**EN 131  
150 Kg MAX**

Ref	H	St	H max	AAI	kg	Box	Price
0940 1010	2,00 + 2,00 m	2 x 7	3,25 m	2,00 m	8,50 kg	1	<b>154,13</b>
0940 1011	2,50 + 2,50 m	2 x 9	4,25 m	2,45 m	10,25 kg	1	<b>193,86</b>
0940 1012	3,00 + 3,00 m	2 x 11	5,25 m	2,95 m	13,75 kg	1	<b>260,35</b>
0940 1013	3,50 + 3,50 m	2 x 13	6,25 m	3,45 m	14,50 kg	1	<b>295,40</b>

ESCALERA ALUMINIO TRIPLE / ECHELLE ALUMINIUM TRIPLE / TRIPLE ALUMINIUM LADDER  
SCALA TRIPLA IN ALLUMINIO / ESCADA DE ALUMÍNIO TRIPLA



**EN 131  
150 Kg MAX**

Ref	H	St	H max	AAI	kg	Box	Price
0940 1020	2,00 + 2,00 + 2,00 m	3 x 7	4,50 m	2,75 m	13,25 kg	1	<b>237,54</b>
0940 1021	2,50 + 2,50 + 2,50 m	3 x 9	6,00 m	3,25 m	15,50 kg	1	<b>295,65</b>
0940 1022	3,00 + 3,00 + 3,00 m	3 x 11	7,50 m	3,90 m	18,50 kg	1	<b>375,40</b>





ESCALERA ALUMINIO / ECHELLE ALUMINIUM / ALUMINIUM LADDER / SCALA IN ALLUMINIO / ESCADA DE ALUMÍNIO



**EN 131  
150 Kg MAX**

ES Anchura de peldaño: 80 mm.  
FR Largeur du panneau: 80 mm.  
EN Step's width: 80 mm.  
IT Larghezza del gradino: 80 mm.  
PT Largura do degrau: 80 mm.

Ref	Escalones	H <sub>total</sub>	H <sub>max</sub>	Al	kg	Paquete	Paquete
<b>0940 1030</b>	2	105 cm	100 cm	0,41 m	2,50 kg	1	<b>41,93</b>
<b>0940 1031</b>	3	130 cm	123,5 cm	0,65 m	3,50 kg	1	<b>52,01</b>
<b>0940 1032</b>	4	155 cm	147 cm	0,89 m	4,20 kg	1	<b>62,90</b>
<b>0940 1033</b>	5	180 cm	170 cm	1,13 m	5,30 kg	1	<b>75,22</b>
<b>0940 1034</b>	6	205 cm	194 cm	1,37 m	6,40 kg	1	<b>89,48</b>
<b>0940 1035</b>	7	230 cm	217 cm	1,61 m	7,30 kg	1	<b>119,40</b>
<b>0940 1036</b>	8	255 cm	241 cm	1,85 m	8,20 kg	1	<b>131,25</b>

TABURETE ALUMINIO / TABOURET ALUM / ALUMINIUM STOOL LADDER / SGABELLO IN ALLUMINIO / BANCO DE ALUMÍNIO

**EN 131  
150 Kg MAX**



ES Anchura de peldaño: 80 mm.  
FR Largeur du panneau: 80 mm.  
EN Step's width: 80 mm.  
IT Larghezza del gradino: 80 mm.  
PT Largura do degrau: 80 mm.

Ref	Escalones	Al	kg	Paquete	Paquete
<b>0940 1040</b>	3	0,67 m	2,40 kg	1	<b>51,29</b>

ESCALERA ALUMINIO SOLDADA - REFORZADA / ECHELLE ALUMINIUM SOUDÉE - RENFORCÉE / WELDED ALUMINIUM LADDER - REINFORCED  
SCALA IN ALLUMINIO SALDATA - RINFORZATA / ESCADA DE ALUMÍNIO SOLDADA - REFORÇADA



**EN 131  
250 Kg MAX**

ES Anchura de peldaño: 120 mm.  
FR Largeur du panneau: 120 mm.  
EN Step's width: 120 mm.  
IT Larghezza del gradino: 120 mm.  
PT Largura do degrau: 120 mm.

Ref	Escalones	H <sub>total</sub>	H <sub>max</sub>	Al	H <sub>step</sub>	kg	Paquete	Paquete
<b>0940 1050</b>	5	1,860 m	1,740 m	1,110 m	490 mm	6,50 kg	1	<b>189,86</b>
<b>0940 1051</b>	6	2,110 m	1,970 m	1,340 m	515 mm	7,50 kg	1	<b>215,55</b>
<b>0940 1052</b>	7	2,360 m	2,200 m	1,570 m	540 mm	8,50 kg	1	<b>239,53</b>
<b>0940 1053</b>	8	2,610 m	2,430 m	1,800 m	565 mm	9,50 kg	1	<b>271,70</b>
<b>0940 1054</b>	9	2,860 m	2,660 m	2,030 m	590 mm	10,50 kg	1	<b>293,47</b>



ESCALERA MULTIUSOS ALUMINIO 4X3 / ECHELLE MULTIUSAGE ALUMINIUM 4X3 / MULTIPURPOSE ALUMINIUM LADDER 4X3  
 SCALA MULTIUSO IN ALLUMINIO 4X3 / ESCADA DE ALUMÍNIO MULTIUSOS 4X3



EN 131  
150 Kg MAX

Ref									
0940 1060	38,5 cm	90 x 38 + 29 cm	151 x 77 cm	1,5 m	2,2 m	3,25 m	13,25 kg	1	260,62

ESCALERA MULTIPOSICIÓN ALUMINIO / ECHELLE MULTIPOSTIONS ALUMINIUM / MULTI POSITION ALUMINIUM LADDER  
 SCALA MULTIPOSIZIONE IN ALLUMINIO / ESCADA DE ALUMÍNIO MULTIPOSIZÕES

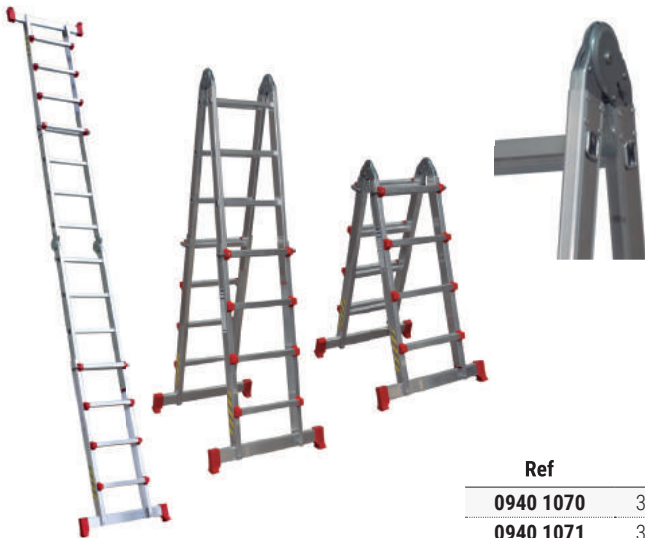

EN 131  
150 Kg MAX

Ref									
0940 1070	38 cm	123 cm	4x4 m	188 cm	383 cm	10,50 kg	1	262,03	
0940 1071	38 cm	148 cm	4x5 m	234 cm	483 cm	12 kg	1	313,50	

ESCALERA MULTIPOSICIÓN HIERRO 4X4 / ECHELLE MULTIPOSTIONS FER 4X4 / MULTI POSITION IRON LADDER 4X4  
 SCALA MULTIPOSIZIONE IN FERRO 4X4 / ESCADA DE FERRO MULTIPOSIZÕES 4X4



EN 131  
150 Kg MAX

Ref									
0940 1080	48 cm	1,17 m	1,99 m	4,5 m	9,8 kg	1	143,97		



ESTANTERÍA METÁLICA / ETAGÈRE METALLIQUE / METALLIC SHELF / SCAFFALE METALLICO / ESTANTE METÁLICA



Por balda / Par etagere / By shelve.  
Per mensole / Por prateleiras.

ES 5 Baldas.  
FR 5 Etageres.  
EN 5 Shelves.  
IT 5 Mensole.  
PT 5 Prateleiras.

Ref				
0940 1100	180x90x30 cm		1	54,26
0940 1101	180x90x30 cm		1	54,26
0940 1102	180x90x40 cm		1	71,99
0940 1103	180x90x40 cm		1	71,99

ESTANTERÍA REFORZADA SIN TORNILLOS / ÉTAGÈRE RENFORCÉE SANS VIS / REINFORCED SHELF UNIT WITHOUT SCREWS  
SCAFFALE RINFORZATO SENZA VITE / ESTANTE REFORÇADA SEM PARAFUSOS



Por balda sin refuerzo / Par etagere sans bordure / By shelve without reinforcement  
Per mensole senza rinforzo / Por prateleiras sem reforço.



Por balda con refuerzo / Par etagere avec bordure / By shelve with reinforcement  
Per mensole con rinforzo / Por prateleiras com reforço.

ES Fácil montaje. Sin tornillos. Gran resistencia.  
FR Montage facile. Sans vis. Grande résistance.  
EN Easy assembly. Without screws. High resistance.  
IT Facile montaggio. Senza vite. Grande resistenza.  
PT Fácil montagem. Sem parafusos. Alta resistência.

PILAR ESTANTERÍA SIN TORNILLOS / MONTANTS D'ETAGERES SANS VIS / SHELF UNIT UPRIGHT WITHOUT SCREWS  
SCAFFALE SENZA VITE / PILAR ESTANTE S/ PARAFUSOS

1



Ref				
0940 1120	300 mm	1 m	2	22,27
0940 1121	400 mm	1 m	2	24,74
0940 1122	500 mm	1 m	2	23,62
0940 1123	600 mm	1 m	2	24,06
0940 1124	300 mm	1,5 m	2	26,09
0940 1125	400 mm	1,5 m	2	26,54
0940 1126	500 mm	1,5 m	2	27,22
0940 1127	600 mm	1,5 m	2	27,66
0940 1128	300 mm	2 m	2	32,17
0940 1129	400 mm	2 m	2	33,52
0940 1130	500 mm	2 m	2	34,64
0940 1131	600 mm	2 m	2	35,99



BANDEJA SIN REFUERZO ESTANTERÍA / PLATEAU SANS BORDURE ETAGERE / TRAY SHELF WITHOUT REINFORCEMENT  
MENSOLA PER SCAFFALE SENZA RINFORZO / PRATELEIRA SEM REFORÇO ESTANTE

2



Ref	↔	Kg ↓		
<b>0940 1132</b>	690 x 300 mm	80 kg	4	<b>12,82</b>
<b>0940 1133</b>	690 x 400 mm	75 kg	4	<b>14,85</b>
<b>0940 1134</b>	930 x 300 mm	75 kg	4	<b>15,30</b>
<b>0940 1135</b>	930 x 400 mm	75 kg	4	<b>18,67</b>

BANDEJA CON REFUERZO ESTANTERÍA / PLATEAU AVEC BORDURE ETAGERE / TRAY SHELF WITH REINFORCEMENT  
MENSOLA PER SCAFFALE SENZA RINFORZO / PRATELEIRA COM REFORÇO ESTANTE

3



Ref	↔	Kg ↓		
<b>0940 1138</b>	690 x 500 mm	180 kg	4	<b>20,02</b>
<b>0940 1139</b>	690 x 600 mm	160 kg	4	<b>22,05</b>
<b>0940 1140</b>	930 x 500 mm	160 kg	4	<b>24,74</b>
<b>0940 1141</b>	930 x 600 mm	150 kg	4	<b>27,22</b>

DIVISORIA BANDEJA ESTANTERÍA / PLATEAU DE SEPARATION ETAGERE / SHELF DIVIDER  
DIVISORIO MENSOLA PER SCAFFALE / DIVISÓRIA PRATELEIRA ESTANTE

4



Ref	↔		
<b>0940 1142</b>	320 x 300 mm	1	<b>8,68</b>
<b>0940 1143</b>	320 x 400 mm	1	<b>9,58</b>
<b>0940 1144</b>	320 x 500 mm	1	<b>10,08</b>
<b>0940 1145</b>	320 x 600 mm	1	<b>11,56</b>

TRAVESAÑO ESTANTERÍA / BORDURES ETAGERES / SHELF UNIT CROSSPIECE / CORRENTE PER SCAFFALE / TRAVE ESTANTE

5



Ref	↔		
<b>0940 1146</b>	103 x 690 mm	1	<b>8,78</b>
<b>0940 1147</b>	103 x 930 mm	1	<b>10,80</b>



CARRETILLA ALMACÉN PLEGABLE ALUMINIO / DIABLE PLIANT EN ALUMINIUM / FOLDING ALUMINIUM HAND TRUCK FOR WAREHOUSE  
 CARRELO MAGAZZINO PIEGHEVOLE ALLUMINIO / CARRINHO DE ARMAZÉN RETRACTIL EM ALUMINIO



Ref		Kg↓			
0940 0401	365x380x960 mm	80 kg	3,5 kg	1	48,80

CARRETILLA ALMACÉN PALA FIJA / DIABLE PALE FIXE / HAND TRUCK FOR WAREHOUSE WITH FIXED PLATE  
 CARRELO MAGAZZINO CON PALA FISSA / CARRINHO DE ARMAZÉN PLATAFORMA FIXA



ES Rueda neumática 0940 2713.  
 FR Roue pneumatique 0940 2713.  
 EN Pneumatic tyre 0940 2713.  
 IT Ruota pneumatica 0940 2713.  
 PT Roda pneumática 0940 2713.



Ref		Kg↓			
0940 0402	1100x520x480 mm	200 kg	8,6 kg	1	56,93

CARRO PLATAFORMA PLEGABLE ALUMINIO / CHARIOT PLATE-FORME PLIANT ALUMINIUM / FOLDING ALUMINIUM PLATFORM TROLLEY  
 CARRELO PIATTAFORMA PIEGHEVOLE ALLUMINIO / CARRO DE PLATAFORMA RETRACTIL EM ALUMINIO



ES Sistema de frenado en ruedas traseras.  
 FR Système de freinage à roues arrière.  
 EN Braking system for rear wheels.  
 IT Sistema di frenatura nelle ruote posteriori.  
 PT Sistema do travão em rodas traseiras.



Ref		Kg↓			
0940 0403	915x615x860 mm	300 kg	12,5 kg	1	103,50





CABALLETE GATO PARA TALLER / CHEVALET POUR ATELIER / CAR JACK STAND 2 TONNES  
CAVALLETTO PER OFFICINA / CAVALETE MACACO PARA OFICINA



Ref	CAP	H min	H max				
0940 0623	2T	270 mm	425 mm	210x195x350 mm	5,5	1	26,45
0940 0624	3T	305 mm	450 mm	240x200x350 mm	7	1	30,75
0940 0625	6T	395 mm	625 mm	320x275x470 mm	15,5	1	57,60

ELEVADOR HIDRÁULICO / CRIC HYDRAULIQUE / HYDRAULIC JACK / MARTINETTO IDRAULICO / MACACO DE RODAS



Ref	CAP	H min	H max				
0940 0626	3T	135 mm	495 mm	690x385x200 mm	34	1	256,50



Ref	CAP	H min	H max				
0940 0627	2,5T	75 mm	500 mm	790x380x180 mm	32	1	272,30

CAMILLA DE TRABAJO 40" / CHARIOT DE VISITE 40" / MECHANIC CREEPER 40" / LETTINO SOTTOMACCHINA 40" / ESTEIRA DE MECÂNICO 40"



ES Cabecera ajustable.  
FR Tête Réglable.  
EN Adjustable headboard.  
IT Poggiatesta regolabile.  
PT Cabeceira justável.

Ref			Kg↓				
0940 0628	Ø75X20 mm	18 mm	90 kg	1030x440x110 mm	12	1	73,40

ASIENTO DE TRABAJO MÓVIL / SIÈGE DE TRAVAIL MOBILE / MOBILE WORK SEAT / SEDILE DA LAVORO MOBILE / BANCO MÓVEL PARA MECÂNICO



ES Cajón portaherramientas.  
FR Tiroir porte-outils.  
EN Hand tools drawer.  
IT Cassetto portattrezzi.  
PT Gabeta porta-ferramenta

Ref			Kg↓				
0940 0629	Ø63,5X20 mm	44 mm	90 kg	395x390x140 mm	5	1	47,85





GATO HIDRÁULICO BOTELLA / CRIC HYDRAULIQUE BOUTEILLE / HYDRAULIC BOTTLE JACK / CRIC IDRAULICO / MACACO HIDRÁULICO GARRAFA



ES Este aparato sólo está destinado para la elevación de cargas. Inmediatamente después de la elevación, apoye la carga sobre un par de caballetes apropiados. Eleve sólo las zonas del vehículo indicadas por el fabricante del mismo. No exceda de la capacidad máxima indicada. Utilícelo únicamente en superficies planas y duras. Nunca trabaje encima, debajo o alrededor de la carga soportada sólo por el gato hidráulico. No use adaptadores o accesorios que no se proporcionen en la caja. Este producto no debe ser alterado. No seguir estas advertencias puede provocar daños personales y/o de la propiedad.

FR Cet appareil est uniquement destiné à l'élévation de charges. Immédiatement après l'élévation, soutenez la charge sur des supports appropriés. Soulevez uniquement les zones du véhicule indiquées par le fabricant de ce dernier. Ne pas dépasser la capacité maximum indiquée. Utilisez uniquement sur des surfaces plates et dures. Ne travaillez jamais au dessus, au-dessous ou autour de la charge supportée par le cric hydraulique. Ne pas utiliser d'adaptateurs ou d'accessoires qui ne sont pas fournis dans le pack. Ce produit ne doit pas être altéré. Ne pas suivre ces avertissements peut provoquer des dommages personnels et/ou de la propriété.

EN This is a lifting device only. Immediately after lifting, support the load on a pair of appropriate jack stands. Lift only on areas of the vehicle as specified by the vehicle manufacturer. Do not exceed the rated capacity. Use only on hard, level surfaces. Never work on, under or around a load supported only by the bottle jack. Do not use adaptors or accessories that are not provided in the pack. No alterations should be made to this product. Failure to follow these warnings may result in personal injury and/or property damage.

IT Questo apparecchio è destinato esclusivamente al sollevamento di carichi. Subito dopo il sollevamento, appoggiare il carico sopra a un paio di cavalletti appropriati. Sollevare unicamente le aree del veicolo indicate dal fabbricante stesso. Non eccedere la capacità massima indicata. Utilizzarlo unicamente su superfici piane e dure. Non lavorare mai in cima, sotto o vicino al carico sostenuto unicamente dal cric idraulico. Non utilizzare adattatori o accessori non presenti nella confezione. Questo prodotto non deve essere alterato. La mancata osservanza di queste avvertenze può provocare lesioni personali e/o danni alla proprietà.

PT Este aparelho destina-se apenas para levantar cargas. Imediatamente após o levantamento, apoiar a carga sobre um par de cavaletes apropriados. Levante apenas as áreas do veículo indicadas pelo fabricante do veículo. Não exceda a capacidade máxima indicada. Use apenas em superfícies planas e duras. Nunca trabalhe acima, abaixo ou em torno da carga suportada apenas pelo macaco hidráulico. Não use adaptadores ou acessórios que não são fornecidos no pacote. Este produto não deve ser alterado. O não cumprimento destas advertências pode resultar em danos pessoais e/ou danos materiais.

Ref	CAP		
0940 0620	4 t	1	42,50
0940 0621	12 t	1	75,85
0940 0622	20 t	1	107,30

CÁMARA DE INSPECCIÓN PORTÁTIL EN COLOR / APPAREIL DE CONTRÔLE EN COULEUR / PORTABLE INSPECTION CAMERA  
TELECAMERA ENDOSCÓPICA A COLORI / CÂMARA DE INSPEÇÃO TFT-LCD A CORES



LCD



COLOR



WATERPROOF  
IP-67



LED LIGHT



FÁCIL ACCESO  
EASY ACCESS



ES Ideal para inspeccionar fácilmente zonas difíciles de alcanzar: motores, tuberías, conductos eléctricos, chimeneas, etc. Minicámara impermeable con cable flexible de 980 mm. Funciona con cuatro pilas (AA).

FR Idéal pour inspecter des zones difficiles d'accès : moteurs, tuyaux, conduits électriques, cheminée, etc. Mini caméra imperméable avec câble flexible et extensible de 980 mm. Fonctionne avec quatre piles (AA).

EN Suitable for inspecting hard-to-reach areas: engines, pipes, electrical conduits, chimneys, etc. Mini waterproof camera with 980 mm flexible extended tube. Works with four (AA) batteries.

IT Ideale per una facile ispezione in aree di difficile accesso: motori, tubi, condotti elettrici, canne fumarie, ecc. Mini camera impermeabile con cavo flessibile ed estensibile da 980 mm. Funziona con quattro pile (AA).

PT Ideal para uma fácil inspeção das áreas de difícil acesso como: motores, tubos, eletrodutos, chaminés, etc. Mini câmera impermeável com cabo flexível e extensível de 980 mm. Funciona com quatro pilhas (AA).

Ref			
0951 4315	1	50	116,25



CARRO HERRAMIENTAS 7 CAJONES MODELO SECURITY / CHARIOTS A OUTILS 7 TIROIRS MOD. SECURITY / 7 DRAWER TOOL TROLLEY "SECURITY MODEL"  
CARRELLI PER UTENSILI 7 CASSETTI MOD. SECURITY / FERRAMENTAS DE CARRINHO 7 GAVETAS MOD. SEGURANÇA



ES Dos ruedas giratorias de fácil acción, una de ellas con freno. Carro con sistema anti vuelco y guías de bolas en los cajones. 7 cajones de apertura al 100% con 2 cajones inferiores especiales para piezas grandes, bandeja superior de polipropileno con portaobjetos integrado y cierre de seguridad en cada cajón y una cerradura centralizada. Cerradura de leva con 2 llaves tubulares. Protección de plástico en las esquinas y agarrador ergonómico, panel lateral perforado para colgar herramientas. Fabricado en acero resistente y pintado con epoxi.

FR Deux roulettes faciles à pivoter, l'une avec frein. Chariot avec système anti-basculement et guidage balles dans les tiroirs. 7 tiroirs ouvrant à 100% avec 2 tiroirs inférieurs spéciaux pour les grandes pièces, plateau supérieur en polypropylène avec glissières intégrées et verrou de sécurité dans chaque tiroir et verrou centralisé. Serrure à came avec 2 clés tubulaires. Protection plastique dans les coins et Poignée ergonomique, panneau latéral perforé pour outils suspendus. En acier résistant et peint ure à l'époxy.

EN It has two casters roll easily, one of them has a brake. It includes an anti-tip system and ball bearing guide in the drawers. It also possesses 7 drawers with a 100% opening, 2 special lower drawers designed for large parts, a top polypropylene tray includes a built-in slide, a safety catchy on each drawer and a central locking arrangement. Cam lock with 2 cam lock keys. It has a plastic protection in the corners, and an ergonomic handle, and a perforated side panel to hang tools. It is made of resistant steel and painted with epoxy.

IT Ha due ruote girevoli di azione facile, una di queste ha freno. Include un sistema anti-ribaltamento e una guida a ricircolo di sfere nei cassetti. Possiede inoltre 7 cassetti con apertura al 100%, 2 cassetti inferiori speciali progettati per pezzi grandi, un vassoio in polipropilene con scivolo incorporato, un fermo di sicurezza su ciascun cassetto e una chiusura centralizzata. Serratura a camma con 2 chiavi tubolari. Negli angoli ha una protezione in plastica, una maniglia ergonomica e un pannello laterale forato per appendere gli strumenti. Realizzato in acciaio e dipinto con epossidico.

PT Dois rodízios fáceis de girar, um com freio. Trolley com sistema anti-inclinação e guias de bolas nas gavetas. 7 gavetas com abertura a 100% com 2 gavetas inferiores especiais para peças grandes, bandeja superior de polipropileno com lâminas integradas e trava de segurança em cada gaveta e uma fechadura centralizada. Fechadura de leva com 2 chaves tubulares. Proteção plástica nos cantos e Alça ergonômica, painel lateral perfurado para ferramentas de suspensão. Feito de aço resistente e pintado com epóxi.



535 x 395 x 55 mm  
Peso máximo por cajón / Maximum drawer weight: 25 kg

535 x 395 x 125 mm  
Peso máximo por cajón / Maximum drawer weight: 35 kg

535 x 395 x 195 mm  
Peso máximo por cajón / Maximum drawer weight: 35 kg

Ref



0940 0105

860x490x790 mm

58 kg

1

570,90



MÓDULOS DE HERRAMIENTAS / MODULE OUTILLAGES / MODULES OF HAND TOOLS / MODULI ATTREZZATURA / MÓDULOS DE FERRAMENTAS



- ES Paneles de espuma, organizadores de herramientas. Fabricación 100% en polietileno de color negro brillante y rojo. Profesional y altamente resistente.
- FR Panneaux en mousse, organisateurs pour rangement d'outils. Fabrication 100% polyéthylène noir brillant et rouge. Professionnel et hautement résistant.
- EN Tool foam organisers. 100% made of glossy black and red polythene. For professional use and highly resistant.
- IT Alloggiamento in schiuma per organizzare l'attrezzatura. I prodotti in polietilene di colore nero lucido e rosso. Professionale e altamente resistenti.
- PT Paineis de espuma, organizadores de ferramentas. Fabricação 100% em polietileno de cor preta brilhante e vermelho. Profissional e altamente resistente.

- ✓ Con herramienta / Avec outils / Tools included / Con attrezzatura / Com ferramenta.
- \* Sin herramienta / Sans outil / Tools not included / Senza attrezzatura / Sem ferramenta.

LLAVE CARRACA 1/2" / CLÉ A CLIQUET 1/2" / TORQUE RATCHET WRENCH 1/2" / CHIAVE A CRICCHETTO 1/2" / CHAVE DE ROQUETE DE 1/2"

16 PCS



- Llave carraca reversible 1/2" / Clé à cliquet réversible 1/2" / Reversible Ratchet Wrench 1/2" / Chiave a cricchetto reversibile 1/2" / Chave de Roquete reversível 1/2".
- Mango corredizo en T / Poignée coulissante en T / Slidign T-Handle / Manico a T scorrevole / Pega deslizante em T.
- Alargadera 3" 8 cm / Rallonge 3" 8 cm / Extention Bar 3" 8cm / Prolunga 3" 8 cm / Extensão 3" 8 cm.
- Alargadera 10" 25 cm / Rallonge 10" 25 cm / Extention Bar 10" 25cm / Prolunga 10" 25cm / Extensão 10" 25 cm.
- Articulación universal / Articulation universelle / Universal Joint Ratchet Angle / Giunto Universale / Articulação universal.
- Bocas M-11 a 27 / Sorties M-11 à 27 / Drive Shallow Socket From M-11 to M-27 / Bussole dal M-11 al 27 / Roquetes M-11 a 27.

Ref			
0940 0410	✓	1	106,60
0940 0310	*	1	26,44

DESTORNILLADORES PLANOS / TOURNEVIS PLATS / FLAT BLADE SCREWDRIVERS / CACCIAVITI TAGLIO / CHAVE DE FENDAS PLANAS

7 PCS

SL - 3x60, SL - 4x80, SL - 5'5x125, SL - 65x100, SL - 6'5x150, SL - 8x150, SL - 6'5x38



Ref			
0940 0411	✓	1	50,40
0940 0312	*	1	26,44

DESTORNILLADORES PHILIPS / TOURNEVIS PHILIPS / CROSSHEAD SCREWDRIVERS / CACCIAVITI PHILLIPS / CHAVE DE FENDAS PHILIPS

7 PCS

PH - 0x60, PH - 1x80, PH - 2x100, PH - 2x150, PH - 3x125, PH - 3x150, PH - 2x38



Ref			
0940 0412	✓	1	50,40
0940 0312	*	1	26,44

DESTORNILLADORES TORX / TOURNEVIS TORX / TORX SCREWDRIVER / CACCIAVITI TORX / CHAVE DE FENDAS TORX

6 PCS

T - 10x80, T - 15x80, T - 20x100, T - 25x100, T - 27x125, T - 3x125



Ref			
0940 0413	✓	1	50,40
0940 0313	*	1	26,44



ALICATES CRICLIPS / PINCE CRICLIPS / CIRCLIP PLIERS / PINZE CIRCLIP / ALICATES CRICLIPS

**4 PCS (INTERIOR Y EXTERIOR)** 0960 0251, 0960 0255, 0960 0261, 0960 0265

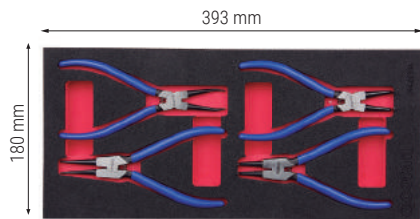

Ref			
<b>0940 0414</b>	✓	1	<b>78,72</b>
<b>0940 0314</b>	*	1	<b>26,44</b>

LLAVE DE CARRACA 1/4" / CLIQUET 1/4" / TORQUE RATCHET WRENCH 1/4" / CHIAVE A CRICCHETTO 1/4" / ROQUETE 1/4"

**11 PCS (4 - 19)**

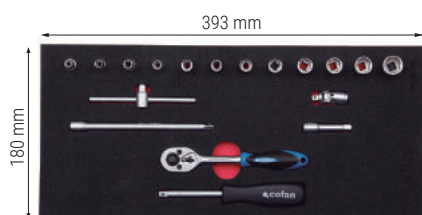

- Destornillador para vasos / Tournevis à douilles / Spinner Handle / Cacciavite quadro / Punho para chave de caixa.
- Llave de carraca reversible 1/4" / Clé à cliquet réversible 1/4" / Reversible Ratchet Wrench 1/4" / Chiave a cricchetto reversibile 1/4" / Llave de roquete reversível 1/4".
- Mango corredizo en T / Poignée coulissante en T / Sliding T-Handle / Manico a T scorrevole / Pega deslizante em T.
- Articulación universal / Articulation universelle / Universal Joint Ratchet Angle / Giunto Universale / Articulação universal.
- Alargadera 5 cm / Extension de 5 cm / Extension Bar 5cm / Prolunga 5cm / Extensão 5 cm.
- Alargadera 15 cm / Extension de 15 cm / Extension Bar 15cm / Prolunga 15cm / Extensão 15 cm.
- Bocas - M-4 a M-14 / Sorties - M-4 à M-14 / Drive Shallow Socket from M-4 to M-14 / Bussole dal M-4 al 14 / Roquetes - M-4 a M-14.

Ref			
<b>0940 0415</b>	✓	1	<b>69,70</b>
<b>0940 0315</b>	*	1	<b>26,44</b>

DESTORNILLADOR CON MANGO EN T, PUNTA HEXAGONAL / TOURNEVIS AVEC MANCHE EN T, POINTE HEXAGONALE / T-HANDLE HEX. SCREWDRIVER  
CHIAVI ESAGONALI MANICO A T / CHAVE DE FENDAS COM PEGA EM T, PONTA HEXAGONAL

**7 PCS** HEX - 2x100, HEX - 2'5x100, HEX - 3x100 - HEX - 4x100 - HEX - 5x150, HEX - 6x150, HEX - 8x200

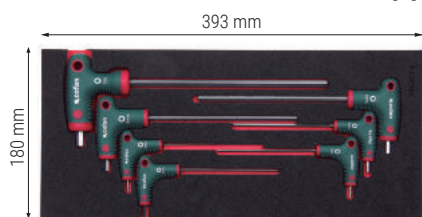

Ref			
<b>0940 0416</b>	✓	1	<b>50,40</b>
<b>0940 0316</b>	*	1	<b>26,44</b>

DESTORNILLADOR CON MANGO EN T, PUNTA TORX / TOURNEVIS AVEC MANCHE EN T, EMBOUT TORX / T-HANDLE TORX SCREWDRIVER  
CHIAVI TORX MANICO A T / CHAVE DE FENDAS COM PEGA EM T, PONTA TORX

**7 PCS TORX** T-10x100, T-15x100, T-20x100, T-27x150, T-30x150, T4x200

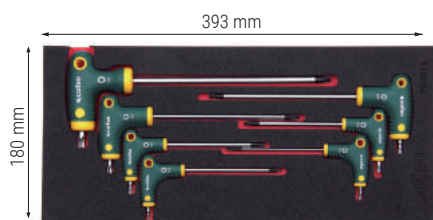

Ref			
<b>0940 0425</b>	✓	1	<b>50,40</b>
<b>0940 0316</b>	*	1	<b>26,44</b>

ALICATES / PINCES / PLIERS / PINZE / ALICATES

**1000 V**

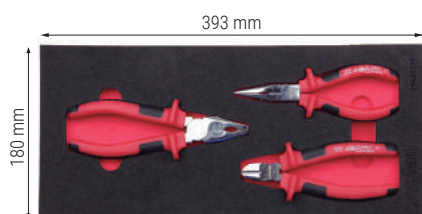

- 1 pc universal reforzado 180 mm / 1 pc universelles renforcée 180 mm / 1pc. Reinforced Combination Pliers 180mm / 1pz. pinza universale reversibile 180mm / 1 pc universal reforçada 180 mm.
- 1 pc telefonista 160 mm / 1 pc téléphone 160 mm / 1pc. Chain Nose Pliers 160mm / 1pz. pinza a becco 160mm / 1 pc telefonista 160 mm.
- 1 pc corte diagonal 160 mm / 1 pc coupe diagonale 160 mm / 1pc. Diagonal Pliers 160mm / 1pz. pinza tagliente diagonale 160mm / 1 pc corte diagonal 160 mm.

Ref			
<b>0940 0417</b>	✓	1	<b>78,72</b>
<b>0940 0317</b>	*	1	<b>26,44</b>





LIMAS Y ESCOFINAS / LIMES ET RAPES / FILES & RASPS / LIME E RASPE / LIMAS E GROSAS



- 1 lima cuadrada de 8", entrefina / 1 lime carrée de 8", entrefine / A Square File 8" medium coarse / 1 lima quadrata di 8" di grana media / 1 lima quadrada de 8", entrefina.
- 1 lima redonda de 8", entrefina / 1 fichier rond 8", entrefine / A Round File 8" medium coarse / 1 lima rotonda di 8" di grana media / 1 lima redonda de 8", entrefina.
- 1 escofina de media caña 8" / 1 râpe demi-ronde 8" / A Half Round Rasp 8" / 1 raspa mezzo tonda di 8" / 1 grossa de meia cana 8".
- 1 escofina redonda de 8" / 1 râpe ronde 8" / A Round Rasp 8" / 1 raspa rotonda di 8" / 1 grossa redonda de 8".

Ref			
0940 0418	✓	1	86,10
0940 0318	*	1	26,44

LLAVES FIJAS DE DOBLE BOCA / CLÉ FIXE À DOUBLE SORTIES / OPEN-END WRENCH / CHIAVI A FORCHETTA DOPPIA / CHAVE DE DUPLA BOCA

10 PCS (6-7), (8-9), (10-11), (12-13), (14-15), (16-17), (18-19), (20-22), (21-23), (24-26)

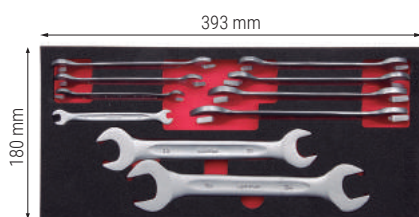

Ref			
0940 0419	✓	1	61,50
0940 0319	*	1	26,44

LLAVES ACODADAS / CLÉS COUDEES / OFFSET RIGN WRENCHES / CHIAVI POLIGONALI GOMIT / CHAVE LUNETA

8 PCS (6-7), (8-9), (10-11), (12-13), (14-15), (16-17), (18-19), (20-22)

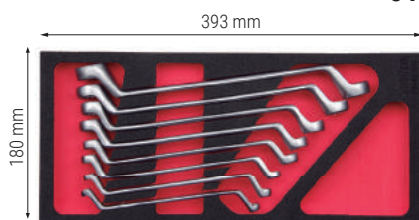

Ref			
0940 0420	✓	1	57,40
0940 0320	*	1	26,44

LLAVES COMBINADAS / CLÉS COMBINÉES COMBINATION WRENCHES / CHIAVI COMBINATE / CHAVES COMBINADAS LUNETA/BOCA

17 PCS (6-7-8-9-10-11-12-13-14-15-16-17-18-19-20-22)



Ref			
0940 0421	✓	1	73,80
0940 0321	*	1	26,44

LLAVES DE PIPA ABIERTAS / CLES A PIPE OUVERTES / ANGLED SOCKET WRENCHES / CHIAVI A PIPA / CHAVES CACHIMBO ABERTAS

10 PCS (8-9-10-11-12-13-14-17-19-21)

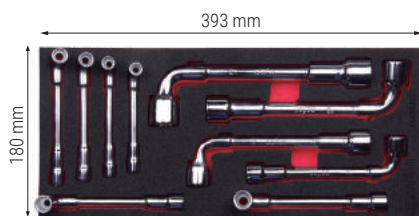

Ref			
0940 0422	✓	1	94,30
0940 0322	*	1	26,44



LLAVES COMBINADAS DE CARRACA / CLÉS COMBINÉES A CLIQUET / RATCHETING COMBINATION WRENCH  
CHIAVI COMBINATE A CRICCHETTO / CHAVES COMBINADAS DE ROQUETE

12 PCS (8 - 9 - 10 - 11 - 12 - 13 - 14 - 15 - 16 - 17 - 18 - 19)



Ref			
0940 0423	✓	1	188,60
0940 0323	*	1	26,44

CAJÓN COMPLETO / TIROIR COMPLET / FULL DRAWER / CASSETTO COMPLETO / CAIXA COMPLETA

29 PCS (Variado)

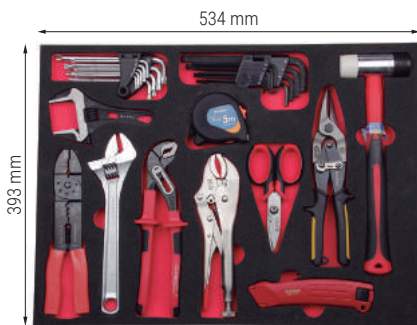

- Juego de 9 llaves acodadas TORX (T10- T50) / Jeu de 9 clés TORX coudées (T10- T50) / 9 pcs. Torx Offset Ring Wrenches set (T10-T50)  
Set di 9 chiavi poligonali gomiti Torx (T10-T50) / Jogo de 9 chaves luneta TORX (T10- T50).

- Alicates para crimpar 220 mm / Pince à sertir 220 mm / Crimping pliers 220mm / Pinza crimpatrice 220 mm / Alicates terminais 220 mm.

- Tijeras electricista 150 mm / Ciseaux d'électricien 150 mm / Electricians Scissors 150 mm / Forbici da elettricista 150 mm  
Tesouras de eletricieta 150 mm.

- Juego 10 llaves allen de bola (1,5 - 10) / Jeu de 10 clés à billes ALLEN (1,5-10) / 10pcs. Ball End Hex Key Set (1.5-10) / Set di  
10 chiavi esagonali a brugola (1,5-10) / Jogo de 10 chaves ALLEN com bola (1,5-10).

- Tijeras articuladas 10" / Ciseaux articulés de 10" / Tin Snip 10" / Tin Snip 10" / Tesouras articuladas de 10".

- Flexómetro antideslizante 19 x 5 mm / Flexomètre antidérapant 19x5 mm / Tape Measure 19x5mm / Metro a nastro 19x5mm  
Fita métrica antideslizante 19x5 mm.

- Tenaza grip recta 10" / Pince grip droite 10" / Locking Pliers 10" / Pinze a morsa 10" / Alicate de grifos de 10".

- Cutter retráctil zamak / Cutter rétractable Zamak / Retractable Trimming Knife Zamak / Taglierino a lama retrattile Zamak /  
X-acto retrátil zamak.

- Llave ajustable moleta central 10" / Clé à molette réglable 10" / Jaw Adjustable Wrench 10" / Chiave regolabile a rullino  
Chave inglesa de 10".

- Llave ajustable gran apertura / Clé à grande ouverture réglable / Short Wide Jaw Adjustable Wrench / Chiave regolabile a  
rullino da grande apertura / Chave inglesa de grande abertura.

- Martillo nylon/pv 35mm / Marteau en nylon/pv 35 mm / Nylon/pv hammer 35mm / Martello in nylon/pv 35mm / Martelo  
de nylon/pv 35 mm.

- Alicate mordaza 1000 V 10" / Pince à mâchoires 1000 V 10" / Tongue and Groove Pliers 1,000V 10" / Pinza multipresa 1000V 10"  
Alicate de grifos 1000V 10".

Ref			
0940 0424	✓	1	237,80
0940 0324	*	1	67,44





CARRO DE HERRAMIENTAS DESMONTABLE CON TRES BANDEJAS / SERVANTES DE TRAVAIL DÉMONTABLES / DETACHABLE WITCH THREE TRAYS  
CARRELLO SMONTABILE A TRE RIPIANI / CARRO DE FERRAMENTAS DEMONTÁVEL COM TRÊS TABULEIROS



**50 Kg MAX**

ES Incluye sistema frenado.  
FR Inclus système de freinage.  
EN It includes a break system.  
IT Comprende anche un sistema di freno.  
PT Inclui sistema de travagem.

Ref				
0940 0107	850x450x820 mm	24 kg	1	225,50

BOLSA HERRAMIENTAS NYLON 60KG / SAC A OUTILS NYLON 60KG / NYLON TOOL BAG NYLON 60KG  
SACCHI PER STRUMENTI NYLON 60KG / SACO FERRAMENTAS NYLON 60KG



Ref	Kg↓			
0940 0532	60	455x280x300mm	1	62,90

CAJA DE HERRAMIENTAS METÁLICA / BOITE A OUTIL METALIQUE / METALLIC TOOL BOX  
CASSETTA PORTA ATTREZI / CAIXA DE FERRAMENTAS METÁLICA



Ref			
0940 0042	400x210x245 mm	1	56,20
0940 0043	500x210x245 mm	1	61,25



CAJA HERRAMIENTAS STUFF SEMI-PROFI / CAISSE A OUTILS STUFF SEMI-PROFI / SEMI-PROFI TOOL BOX  
CASSETTA DEGLI ATTREZZI PER MATERIALE SEMIPROFESSIONALE / CAIXA FERRAMENTAS MOD STUFF SEMI-PROF 12"



ES Caja de herramientas con cierres de plástico, compuesta de varios compartimentos exteriores divididos en secciones y dos niveles interiores, para simplificar la clasificación de los elementos.

FR Boite à outils avec fermetures plastiques, composée de plusieurs compartiments extérieurs divisés tous les deux en parties, et de deux niveaux intérieurs pour simplifier la classification des éléments.

EN Tool box with safety plastic lock, various upper outside parts divided in sections, inside part divided in two levels to simplify the tool storage.

IT Cassetta per attrezzi con chiusure in plastica, composta da vari vani esterni, ciascuno diviso in sezioni, e due livelli interni per semplificare la disposizione degli attrezzi.

PT Caixa de ferramentas com fechos plásticos, composta de vários compartimentos exteriores divididos com secções e dois níveis interiores para simplificar a classificação dos elementos.

Ref	M				
0940 0200	12"	310x180x130 mm	PLASTIC LOCKS	1	9,78
0940 0201	16"	410x230x210 mm	PLASTIC LOCKS	1	18,41
0940 0202	20"	520x260x250 mm	PLASTIC LOCKS	1	29,74
0940 0204	26"	585x330x330 mm	PLASTIC LOCKS	1	45,60

CAJA HERRAM. MODUL SYSTEM STUFF SEMI-PROFI 20" / CAISSE À OUTILS PLASTIQUE / TOOL BOX WITH SAFETY METAL LOCKS  
CASSETTA PER ATTREZZI / CAIXA FERRAMENTAS MOD SYSTEM STUFF SEMI-PROF 20"



Ref	M				
0940 0205	20"	525x255x325 mm	PLASTIC LOCKS	1	50,34

CAJA HERRAMIENTAS "MOD. BRINELL" / BOITE À OUTILS "MOD. BRINELL" / HAND TOOLS BOX "MOD. BRINELL"  
CASSETTA PER ATTREZZI "MOD. BRINELL" / CAIXA FERRAMENTAS MOD "BRINELL"



Ref			
0940 0215	462x256x242 mm	1	42,12
0940 0216	547x271x278 mm	1	48,31
0940 0217	595x289x328 mm	1	61,26



CAJA DE HERRAMIENTAS "HEAVY DUTY" / BOITE À OUTILS PROFESSIONNELLE "HEAVY DUTY" / TOOL BOX "HEAVY DUTY"  
CASSETTA PER ATTREZZI, ROBUSTA "HEAVY DUTY" / CAIXA DE FERRAMENTA "HEAVY DUTY"



ES Soporte especial, cierre hermético, cierres de seguridad, antideslizante, organizador transparente y doble plano de trabajo.

FR Support spécial, fermeture hermétique, fermetures de sécurité, ne glisse pas, organisateur de rangement transparent, double plan de travail.

EN Special holder, hermetic closing, safety lock, antislip, transparent sections, double work surface.

IT Supporto speciale, chiusura ermetica, chiusura di sicurezza, antiscivolo, contenitore trasparente, doppio piano di lavoro.

PT Suporte especial, fecho hermético, fechos de segurança, anti-deslizante, secções transparentes, duplo plano de trabalho.

Ref				
0940 0206	590x345x352 mm		1	91,42
0940 0207	590x345x352 mm		1	80,02

CAJA DE HERRAMIENTAS HEAVY DUTY CON RUEDAS / BOITE À OUTILS 'HEAVY DUTY' AVEC ROUES / HEAVY DUTY TOOL BOX WITH WHEELS  
CASSETTA PORTA STRUMENTI PESANTI CON RUOTE / CAIXA PARA FERRAMENTAS HEAVY DUTY COM RODAS



ES Asa extensible para transporte.

FR Poignée extensible pour transport.

EN Extendable handle for easy transportation.

IT Manico estensibile per trasporto.

PT Asa extensível.

Ref			
0940 0208	590x345x352 mm	1	124,49

CAJA HERRAMIENTAS COMPACT CON RUEDAS / AISSE A OUTILS COMPACTE AVEC ROUES / HAND TOOL BOX WITH WHEELS  
CASSETTA PER GLI ATTREZZI COMPATTA CON RUOTE / CAIXA DE FERRAMENTAS COMPACTA COM RODAS



Cajón inferior desmontable.  
Tiroir inférieur détachable.  
Detachable bottom drawer.  
Cassone inferiore smontabile.  
Gaveta inferior desmontável.



Bandeja y baúl portaherramientas.  
Plateau et support porte-outils.  
Tray and tools holder.  
Vassoio e baule portattrezzi.  
Bandeja e caixa porta ferramentas.

Ref			
0940 0209	710x500x360 mm	1	94,74



ESTUCHES DE PLÁSTICO / VALISETTE PLASTIQUE / PLASTIC STORAGE TOOL BOX / VALIGETTE IN PLASTICA / CAIXAS DE PLÁSTICO



7, 8 y 12 compartimentos / compartiments / Sections / Compartimenti / Compartimentos.

Ref					
<b>0940 0220</b>	120x100x30 mm	7	1	96	<b>1,77</b>
<b>0940 0221</b>	190x155x37 mm	8	1	32	<b>3,33</b>
<b>0940 0222</b>	250x200x44 mm	12	1	32	<b>4,78</b>

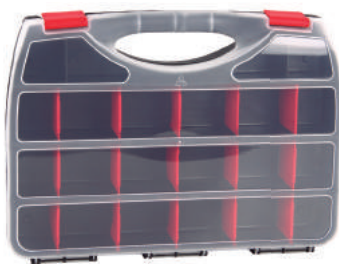

22 compartimentos / compartiments / Sections / Compartimenti / Compartimentos.

Ref					
<b>0940 0223</b>	364x268x66 mm	22	1	27	<b>12,27</b>



21 compartimentos / compartiments / Sections / Compartimenti / Compartimentos.

Ref				
<b>0940 0226</b>	460x325x80 mm	21	1	<b>22,36</b>

ARMARIO 10 GAVETAS / ARMOIRE POUR CASIERS DE 10 COMPARTIMENTS / TOOL CRIB WITH 10 STORAGE BINS  
CASSETTIERA DOPPIA A 10 COMPARTIMENTI / ARMÁRIO 10 GAVETAS



ES Realizado en plástico y diseñado para poder unir otros armarios de las mismas características en cada uno de los 4 lados.

FR Fabriqué en plastique et conçu pour pouvoir unir d'autres armoires de mêmes caractéristiques sur chacun des 4 côtés.

EN Plastic tool crib with 10 storage bins. Designed to be able to join similar cribs to each from the 4 sides.

IT Realizzata in plastica e progettata per poter unire altri cassetti dello stesso modello per ognuno dei 4 lati.

PT Fabricado em plástico e desenhado para poder unir outros armários das mesmas características em cada um dos 4 lados.

Ref			
<b>0940 0225</b>	155x100x225 mm	1	<b>20,38</b>





GAVETA NEGRA / CASIER NOIR / BLACK STORAGE BIN / CASSETTO NERO / CAIXA DE ARMAZENAMENTO PRETA

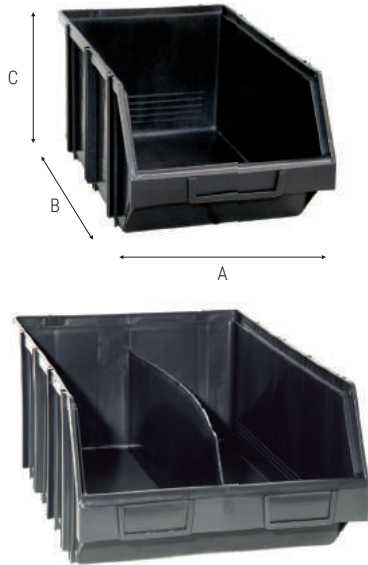

ES Gaveta apilable para guardar elementos, contiene encajonado para incluir etiqueta identificativa.

FR Casier empilable pour ranger des éléments, contient un support pour ajouter une étiquette d'identification.

EN Stackable storage bin for tools with large label holders that are molded in.

IT Cassetto impilabile per immagazzinare oggetti, contiene spazio apposito per inserire etichette identificative.

PT Caixa de armazenamento para guardar ferramentas, contem espaço para identificação de etiqueta.

Ref	MODEL	A x B x C			
0940 0210	1,1	108x170x80 mm	1	35	1,56
0940 0211	2,1	150x235x130 mm	1	35	3,11
0940 0212	3,1	210x340x165 mm	1	35	7,02
0940 0213	4,1	310x490x190 mm	1	10	14,87

Ref	MODEL	A x B x C		
0940 0214	4,1	310x490x190 mm	1	15,59

GAVETA "SÚPER" / CASIER "SUPER" / STORAGE BIN "SUPER" / CASSETTO "SUPER" / CAIXA DE ARMAZENAMENTO "SUPER"

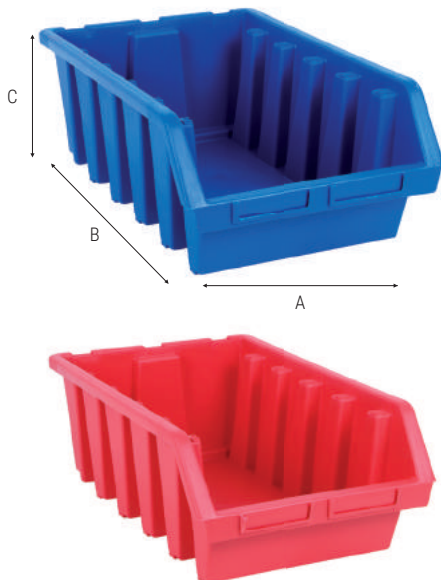

ES Gaveta "Super" apilable para guardar elementos. Contiene encajonado para incluir etiqueta identificativa.

FR Casier "Super", empilable pour ranger des éléments, dispose d'un emplacement prévu pour intégrer une étiquette identificative.

EN Stackable storage bin "Super" for your tools with large label holder that is molded in.

IT Cassetto impilabile "Super" per immagazzinare oggetti, contiene spazio apposito per inserire etichette identificative.

PT Caixa de armazenamento "Super" para guardar elementos, contem espaço para etiqueta de identificação.

Ref	MODEL	A x B x C			
0940 0250	Super 2	115x161x74 mm		1	2,07
0940 0251	Super 3	170x240x126 mm		1	5,15
0940 0252	Super 4	204x340x156 mm		1	8,68
0940 0253	Super 5	333x500x187 mm		1	20,18
0940 0254	Super 2	115x161x74 mm		1	2,07
0940 0255	Super 3	170x240x126 mm		1	5,15
0940 0256	Super 4	204x340x156 mm		1	8,68
0940 0257	Super 5	333x500x187 mm		1	20,18

CARRIL PARA GAVETAS "SÚPER" / RAIL POUR CASIER "SUPER" / SUPPORT FOR STORAGE BINS "SUPER"  
GUIDA PER CASSETTO "SUPER" / BARRA PARA CAIXA DE ARMAZENAMENTO "SUPER"



ES Carril para gavetas "Super". Carril para atornillar a la pared y poder colgar gavetas.

FR Rail pour casier "Super". Rail pour visser à la paroi et destiné à accrocher les casiers.

EN Grip for rail to be screwed on the wall to hang up the storage bins.

IT Guida per cassetto "Super". Guida da avvitare alla parete per poterci fissare il cassetto.

PT Barra para aparafusar na parede e suportar as caixas de armazenamento.

METAL



Ref			
0940 0259	495x40 mm	1	3,74

PLÁSTICO



Ref			
0940 0258	495x40 mm	1	1,77



CAJA HERRAMIENTAS MULTIFUNCIÓN / CAISSE À OUTILS MULTIFONCTIONS / MULTIFUNCTION TOOL BOX  
 CASSETTA PER ATTREZZI MULTIFUNZIONE / CAIXA DE FERRAMENTAS MULTIFUNCIONAL

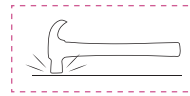

RESISTENCIA A IMPACTOS  
 HIGH STRENGTH SHOCK-RESISTANT

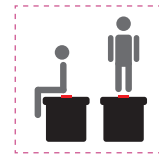

120 KG

RESISTENCIA A IMPACTOS  
 HIGH STRENGTH SHOCK-RESISTANT



CIERRE HERMÉTICO  
 SEAL ON ILD

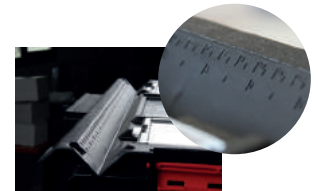

HUECO CON REGLA PARA CORTAR  
 CUTTING SLOT



EXCELENTE MANEJO  
 EXCELLENT MANEUVERABILITY



FUERTES CONECTORES  
 SOLID CONECTORS



MANGO RESISTENTE  
 SOLID HANDLE



Ref	Kg↓			
0940 0263	50 kg	585 x 385 x 190 mm	1	95,06



Ref	Kg↓			
0940 0264	50 kg	585 x 385 x 320 mm	1	108,05



Ref	Kg↓			
0940 0265	50 kg	585 x 385 x 420 mm	1	128,30





PLATAFORMA CON RUEDAS CAJA MULTIFUNCIÓN / PLATE-FORME AVEC ROUES CAISSE MULTIFONCTION  
 PLATFORM WITH WHEELS MULTIFUNCTION BOX / PIATTAFORMA CON RUOTE PER CASSETA MULTIFUNZIONE  
 PLATAFORMA COM RODAS CAIXA MULTIFUNCIONAL



Ref	Kg↓			
0940 0266	50 kg	610 x 470 x 180 mm	1	94,55

CAJA HERRAMIENTAS ABIERTA MULTIFUNCIÓN / CAISSE À OUTILS OUVERTE MULTIFONCTIONS / OPEN MULTIFUNCTION TOOL BOX  
 CASSETA PER ATTREZZI MULTIFUNZIONE / CAIXA DE FERRAMENTAS ABERTA MULTIFUNCIONAL



Ref	Kg↓			
0940 0267	50 kg	576 x 359 x 237 mm	1	56,05

CAJA MULTIFUNCIÓN CON RUEDAS / CAISSE À OUTILS MULTIFONCTION AVEC ROUES / MULTIFUNCTION BOX WITH WHEELS  
 CASSETA PER ATTREZZI MULTIFUNZIONE CON RUOTE / CAIXA DE FERRAMENTAS MULTIFUNCIONAL COM RODAS

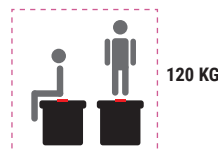

RESISTENCIA A IMPACTOS  
 HIGH STRENGTH SHOCK-RESISTANT



Ref	Kg↓			
0940 0268	50 kg	739 x 385 x 322 mm	1	226,75



BANCO TRABAJO / WORKBENCH / WORKBENCH / TAVOLO DA LAVORO / BANCADA TRABALHO



PANEL PORTAHERRAMIENTAS DE ACERO / PANNEAU PORTE-OUTILS EN ACIER / TOOL STEEL PANEL  
PANNELLO PORTA ATTREZZI IN ACCIAIO / PAINEL DE AÇO PORTA-FERRAMENTAS

1

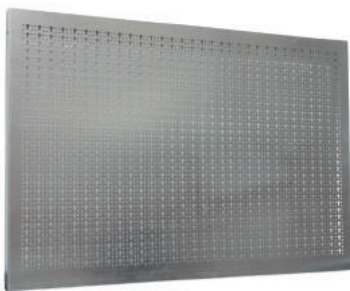

Ref				
0940 0012	1000 x 860 x 30 mm	9 kg	1	180,40
0940 0013	1500 x 860 x 30 mm	8 kg	1	228,55
0940 0014	2000 x 860 x 30 mm	11 kg	1	273,97
0940 0015	1300 x 860 x 30 mm	8 kg	1	211,49
0940 0016	1800 x 860 x 30 mm	11 kg	1	250,98

KIT COLUMNAS PANEL PORTA HERRAMIENTAS / KIT COLONNES PANNEAU PORTE-OUTILS / TOOL PANEL COLUMN KIT  
KIT PANNELLO A COLONNA PORTA ATTREZZI / KIT COLUNAS PAINEL PORTA-FERRAMENTAS

2



14 Gavetas / Boite de rangement / Drawers / Confezione / Gavetas

ES Válido para: 0940 0015 / 0940 0016.

FR Valide pour: 0940 0015 / 0940 0016.

EN Valid for: 0940 0015 / 0940 0016.

IT Valido per: 0940 0015 / 0940 0016.

PT Válido para: 0940 0015 / 0940 0016.

Ref				
0940 0076	100 x 860 mm	3 kg	1	127,92



BANCO TRABAJO TABLERO DE ACERO / ETABLI PANNEAU ACIER / STEEL WORKBENCH / TAVOLO DA LAVORO IN ACCIAIO / BANCADA TRABALHO AÇO

3



Ref				
0940 0071	1000 x 700 mm	42 kg	1	482,20
0940 0072	1500 x 700 mm	60 kg	1	618,28



Ref				
0940 0073	2000 x 700 mm	65 kg	1	810,16

CAJÓN BANCO DE TRABAJO / TIROIR ETABLI / WORKBENCH DRAWER / CASSETTO DA LAVORO PER TAVOLO / GAVETA BANCADA DE TRABALHO

4



Sin cerradura / Sans serrure / No lock / Senza serratura / Sem fechadura

Ref				
0940 0074	600 x 510 x 145 mm	9 kg	1	183,35



Con cerradura / Avec serrure / With lock / Con serratura / Com fechadura

Ref				
0940 0075	600 x 510 x 145 mm	9 kg	1	197,42

PANEL PORTAHERRAMIENTAS ECONOM / PANNEAU PORTE-OUTILS ECONOM / ECONOM TOOL PANEL  
PANNELLO PORTA ATTREZZI ECONOM / PAINEL PORTA-FERRAMENTAS ECONOM

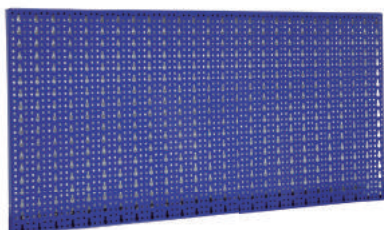

Ref				
0940 0078	1000 x 500 mm	2 kg	1	43,49



KIT ACCESORIOS PANEL PORTAHERRAMIENTAS 62 PCS / KIT ACCESSOIRES PANNEAU PORTE-OUTILS 62 PCS / 62 PCS ACCESSORIES FOR TOOL PANEL  
 KIT ACCESSORI PER PANNELLO PORTA ATTREZZI 62 PZ / KIT ACESSÓRIOS PAINEL PORTA-FERRAMENTAS 62 PÇS

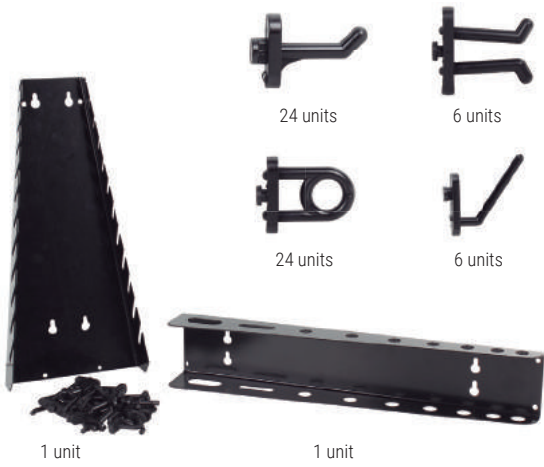

Ref		
0940 0077	1	114,27

PACK 2 GAVETAS PANEL HERRAMIENTAS / PACK 2 BOITE DE RANGEMENT PANNEAU OUTILS / 2 DRAWERS PACKPANEL HOOKS  
 CONFEZIONE 2 CASSETTI PER PANNELLO PORTA ATREZZI / PACK 2 GAVETAS PAINEL FERRAMENTAS



Ref			
0940 0030	100 x 50 x 95 mm	1	5,72

GANCHOS PANEL HERRAMIENTAS / CROCHETS PANNEAU OUTILS / TOOL PANEL HOOKS  
 GANCI PER PANNELLO PORTA ATTREZZI / GANCHOS PAINEL FERRAMENTAS

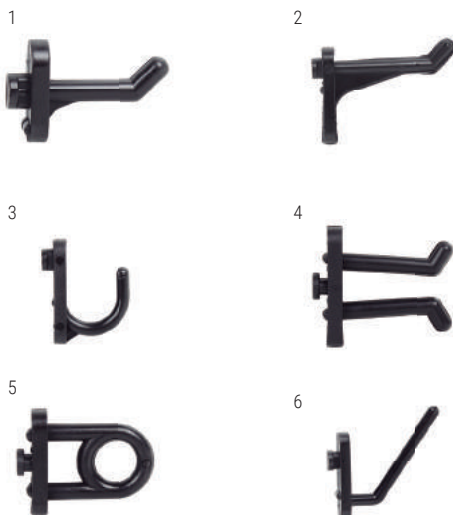

	Ref		
1	0940 0023	5	0,68
2	0940 0024	5	0,68
3	0940 0025	5	0,68
4	0940 0026	5	0,68
5	0940 0027	5	0,68
6	0940 0029	5	0,68



GAVETA POLIPROPILENO ESPECIAL MOSTRADOR / CASIER POLYPROPYLENE SPECIAL PRESENTOIR  
POLYPROPYLENE DRAWER SPECIAL SHELF DISPLAY STAND / CASSETTO SPECIALE IN POLIPROPILENE / GAVETA POLIPROPILENO ESPECIAL MOSTRADOR



Ref			
0940 0270	113 x 500 x 85 mm	1	13,42
0940 0271	113 x 600 x 85 mm	1	15,81

SEPARADOR TRANSVERSAL PLÁSTICO / SÉPARATEUR TRANSVERSAL PLASTIQUE  
PLASTIC TRANSVERSE DIVIDER / DIVISORIO TRASVERSALE IN PLASTICA  
SEPARADOR TRANSVERSAL PLÁSTICO

Ref			
0940 0275	1		1,46



TOPE TRASERO PARA GAVETA / TOP ARRIÈRE POUR CASIER / BACK STOP FOR DRAWER  
BLOCCO CASSETTO / TOPE TRASEIRO PARA GAVETA

Ref			
0940 0276	1		2,91

PANEL PLÁSTICO PARED PARA HERRAMIENTAS CON ACCESORIOS / PANNEAU PLASTIQUE MURAL POUR OUTILS AVEC ACCESSOIRES  
WALL PLASTIC PANEL FOR TOOLS AND ACCESSORIES / PANNELLO IN PLASTICA DA PARETE PER ATTREZZATURE CON ACCESSORI  
PAINEL PLASTICO PARA FERRAMENTAS DE PAREDE C/ACCESORIOS



Ref				
0940 0260	360 x 400 mm	21	1	32,76

SET ACCESORIOS PANEL PLÁSTICO HERRAMIENTAS / SET ACCESSOIRES POUR PANNEAU A OUTILS PLASTIQUE  
ACCESSORIES KIT FOR PLASTIC HAND TOOL HANGING BOARD / SET ACCESSORI PER PANNELLO IN PLASTICA, ATTREZZATURA  
CONJUNTO ACESSÓRIOS PAINEL PLÁSTICO FERRAMENTAS



Ref				
0940 0261	12 pcs	1	4,68	✓

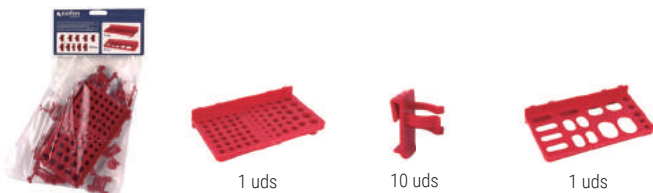

Ref				
0940 0262	12 pcs	1	5,20	✓





CORDÓN ANTICAÍDAS / CORDE ANTICHUTES / TOOL LANYARD / CORDINO ANTICADUTA / CORDA ANTIQUEDA



ES Cordón retráctil para herramientas con cierre automático y nudo fijo. Cordón de nylon con muelle interno de acero para absorber el impacto al caerse una herramienta. Evita que las herramientas puedan provocar lesiones si se caen accidentalmente. Evita que las herramientas caigan y aumenta la productividad.

FR Corde rétractable pour outils avec deux fermetures automatiques et nœud fixe. Corde en nylon avec ressort interne en acier pour absorber l'impact quand un outil tombe. Evite que les outils puissent provoquer des lésions s'ils tombent accidentellement. Evite que les outils tombent et augmente la productivité.

EN Retractable tool lanyard with 2 lock snaps and fixed loop. Nylon tether with steel spring inside to absorb the shock of a tool when it falls. Avoid that tools may cause injuries if they fall accidentally. Prevents tools from dropping and increases productivity.

IT Cordino retrattile per strutture con due chiusure automatiche e chiusura a fune. Cordino in nylon con molla di ritorno in acciaio per assorbire l'impatto. Impedisce che si provochino lesioni per cadute accidentali. Impedisce la caduta ed aumenta la produttività.

PT Corda retrátil para ferramentas com dois fechos automáticas e nó fixo. Corda de nylon com mola de aço interna para absorver o impacto quando cai uma ferramenta. Evita que as ferramentas causem ferimentos se caírem acidentalmente. Evita que as ferramentas caíam e assim aumenta a produtividade.

CON 2 MOSQUETONES / AVEC 2 MOUSQUETONS / WITH 2 CARABINERS  
CON 2 MOSCHETTONI / COM 2 MOSQUETÕES

Ref	↔	📦	📊
0940 0080	1,50 m	1	20,80

CON MOSQUETÓN Y NUDO / AVEC MOUSQUETON Et NOEUD / WITH CARABINER AND LOOP  
CON MOSCHETTONE E CHIUSURA A FUNE / COM MOSQUETÃO E NÓ

Ref	↔	📦	📊
0940 0081	1,70 m	1	19,15

BOLSA PORTAHERRAMIENTAS - 6 BOLSILLOS / PORTE OUTILS - 6 POCHEs / TOOL POUCH - 6 POCKETS  
CONTENITORE PORTA ATTREZZI - 6 TASCHE / PORTA-FERRAMENTAS - 6 BOLSOS



Ref	📦	📊
0940 0352	1	15,92

PORTAHERRAMIENTAS "SÚPER" CON CINTURÓN - 12 BOLSILLOS / PORTE OUTILS "SUPER" AVEC CEINTURE - 12 POCHEs  
DOUBLE TOOL POUCH WITH WEB BELT - 12 POCKETS / CINTURA PORTA ATTREZZI "SUPER" - 12 TASCHE  
CINTO PORTA-FERRAMENTAS, HIGHLINE, EM COURO - 12 BOLSOS



Ref	📦	📊
0940 0350	1	35,03

PORTAHERRAMIENTAS DOBLE CON CINTURÓN - 11 BOLSILLOS / PORTE OUTILS DOUBLE AVEC CEINTURE - 11 POCHEs  
DOUBLE TOOL POUCH WITH WEB BELT - 11 POCKETS / DOPPIA CINTURA PORTA ATTREZZI - 11 TASCHE  
DUPLO CINTO PORTA-FERRAMENTAS EM COURO - 11 BOLSOS



Ref	📦	📊
0940 0351	1	22,52





SETS HERRAMIENTAS PROFESIONAL 218 PCS / SET D'OUTILS PROFESSIONNEL 218 PCS / 218 PCS PROFESSIONAL TOOL SET  
SET DI CHIAVI PROFESSIONALE 218 PEZZI / JOGO DE FERRAMENTAS PROFISSIONAL 218 PÇS

218 pcs

1/4" - 1/2" - 3/8"

- ES Calidad profesional.
- FR Qualité professionnelle.
- EN Professional quality.
- IT Qualità professionale.
- PT Qualidade profissional.



458 x 380 x 81 mm

Ref			
	15 Vasos/sockets 1/2": 10-11-12-13-14-15-17-19-20-21-22-24-27-30-32mm		
	10 Vaso/socket 3/8" :10-11-12-13-14-15-16-17-18-19mm		
	13 Vasos/sockets 1/4": 4-4.5-5-5.5-6-7-8-9-10-11-12-13-14mm		
	5 Vasos largos/deep sockets 1/2" :16-17-18-19-22mm Super Lock		
	6 Vasos largos/deep sockets 3/8":10-11-12-13-14-15mm Super Lock		
	7 Vasos largos/deep sockets 1/4": 4-5-6-7-8-9-10mm Super Lock		
	3 Vaso Torx/star socket 1/2" E20-E22-E24 Knurled		
	6 Vaso Torx/star socket 3/8" E10-11-12-14-16-18 Knurled		
	5 Vaso Torx/star socket 1/4" E4-5-6-7-8 Knurled		
	3 Llaves de carraca/ratchet handle 1/2"+3/8"+1/4" 45T		
	3 Articulaciones universales/universal joint 1/2"+3/8"+1/4"		
	5 Barras de extensión/extension bar 1/2"x125-250mm		
	3/8"x125mm, 1/4"x50-100mm		
	1/2" Adaptador para barra deslizante/sliding T head(com.1/2"x250ext.)		
	3 Llaves de vaso para bujías/spark plug socket 1/2"x16+21mm		
	3/8"x18mm 60L		
1400 9018	1 Destornillador de vaso/screwdrive handle 1/4"	1	2
	1 Mango deslizante en T/sliding T handle 1/4"		
	1 Destornillador porta-vasos/spinner handle 1/4"		
	3 Adaptadores de punta hexagonal/bit adapter 1/2"+3/8" for 8mm bits, 1/4" for 1/4" bits		
	12 Llaves combinadas/Combination wrench: 8-9-10-11-12-13-14-15-16-17-18-19mm		
	30 Puntas de destornillador/bitsocket 1/4" CV-B.S.: PH1-2-3 ; FD4-5.5-6.5-7		
	PZ1-2-3 ; H3-4-5-6 ; T8-9-10-15-20-25-27-30		
	TT8-9-10-15-20-25-27-30(Temp)		
	30 bit 8x30mmL HX7-8-9-10-12 ;PH3-4 ;		
	FD8-10-12;M5-6-8-10;TX20-25-27-30-40-45-50;		
	TT20-25-27-30-40-45-50(Temp) ; PZ3-4		
	2 Puntas de destornillador/bitsocket 1/2"xT55-T60		
	44 bits 1/4"x25mmL HX3-4-5-6(Temp)		
	HX 3-4-5-6;S1-2-3;M4-5-6-8;PH1-2-3;PZ1-2-3;		
	FD3-4-5-5.5-6-6.5-7 ; T8-9-10-15-20-25-27-30		
	TT8-9-10-15-20-25-27-30(Temp)		
	10 Llaves Allen/hex key wrenches: 1.27-1.5-2-2.5-3-3.5-4-4.5-5-6mm		
			258,65

SETS HERRAMIENTAS PROFESIONAL 171 PCS / COFFRET D'OUTILS PROFESSIONNELS 171 PCS / 171 PCS PROFESSIONAL TOOL SET  
SET ATTREZZATURA PROFESSIONALE 171 PEZZI / CONJUNTO DE FERRAMENTAS PROFISSIONAL 171 PÇS

171 pcs

1/4" - 1/2" - 3/8"

- ES Calidad profesional.
- FR Qualité professionnelle.
- EN Professional quality.
- IT Qualità professionale.
- PT Qualidade profissional.



445 x 360 x 81 mm

Ref			
	1/4" Vasos/Sockets: 4, 4.5, 5, 5.5, 6,7,8,9,10,11,12,13, 14mm		
	3/8" Vasos/Sockets: 10-11-12-13-14-15-16-17-18-19mm		
	1/2" Vasos/Sockets: 10 - 22, 24, 27, 30, 32mm		
	1/2" Vaso largas/Deep Sockets: 16, 17, 18, 19, 22mm		
	3/8" Deep Sockets: 10, 11, 12, 13, 14, 15mm		
	1/4" Vaso largas/Deep Sockets: 4, 5, 6, 7, 8, 9, 10mm		
	1/2" Vaso largas Torx/Star Sockets: E20-24		
	3/8" Vaso largas Torx/Star Sockets: E10, 11, 12, 14, 16, 18		
	1/4" Vaso largas Torx/Star Sockets: E4, E5, E6, E7, E8		
	1/2" + 3/8" + 1/4" Llaves de carraca/Ratchet handle - 72T		
	1/4" Mango deslizante T/Sliding T handle		
	1/4" Destornillador porta-vasos/Spinner Handle		
	1/2" x 8mm + 3/8" x 8mm Adaptador de punta exagonal/Bit adapter		
	1/4" x 1/4" Adaptador de punta exagonal/Bit adapter		
1400 9017	30 1/4" Puntas de destornillador/Bit Sockets	1	4
	HX 3-4-5-6 / FD 4-5-5.5-6.5-7 / PH 0-1-2 / PZ 0-1-2		
	TX 8-9-10-15-20-25-27-30 / TT 8-9-10-15-20-25-27-30 (Temp)		
	1/2" + 3/8" + 1/4" Universal Joint		
	1/2" Adaptador para barra deslizante/Sliding T Head (com. 1/2"x250ext.)		
	Llaves Allen/Hex Key Wrenches: 1-1.5-2-2.5-3-4-5mm		
	5 1/2" Barras de extensión/Extension Bars: 125 & 250mm		
	3/8"x125mm / 1/4"x50-100mm		
	3 1/2" x 16 & 21mm - 3/8" x 18mm Spark Plug Sockets		
	Llaves de vaso para bujías/Bits 8x30mm L6150		
	HX7-8-10-12-14 / FD 8-10-12 / PH 3-4 / PZ 3-4		
	TX 40-45-50-55-60-70 / TT 40-45-50-55-60-70 (Temp)		
	1/4" x 25mm L Bits		
	TX 5-6-7 / TT7 (Temp) / RM 5-6-7-8-9 / M 5-6-8		
	TS 10-15-20-25-27-30-40-45 (Temp)		
	Set equipado en un maletín moldeado por soplado/Set in Blow Mold Case		



SETS HERRAMIENTAS 108 PCS / COFFRET D'OUTILS 108 PCS / 108 PCS TOOL SET  
SET ATTREZZATURA 108 PEZZI / CONJUNTO DE FERRAMENTAS 108 PÇS

108 pcs  
1/4" - 1/2"



380 x 270 x 80 mm



Ref				
1400 9016	13)	1/4" Llaves de vaso Dr./Dr. Sockets: 4, 4.5, 5, 5.5, 6,... - 14mm		
	17)	1/2" Llaves de vaso Dr./Dr. Sockets: 10 - 22, 24, 27, 30, 32mm		
	2)	1/4" Barras de extensión Dr./Dr. Ext Bars: 50 & 100mm		
	5)	1/2" Llaves de vaso largas Dr./Dr. Deep Sockets: 14, 15, 17, 19, 22mm		
		1/4" Destornillador porta-vasos Dr./Dr. Spinner Handle, Go Through Type		
	8)	1/2" Llaves de vaso Dr./Dr. Star Sockets: E10, E11, E12, E14, E16, E18, E20, E22		
		18) 1/4" Puntas de destornillador Dr./Dr. Insert Socket Bits:		
		4-Hex: 3, 4, 5, 6mm / 2-Ph: 1, 2 / 2-Poz: 1, 2		
		3-Slo: 4, 5.5, 6.5mm / 7-Torx: T8, T10, T15, T20, T25, T27, T30		
		1/4" Articulación universal Dr./Dr. Universal Joint		
		1/4" Barra deslizante en T/Dr. Sliding T Bar		
		4) Llaves Allen/Hex Key Wrenches: 1.27, 1.5, 2, 2.5mm		
		8) 1/4" Llaves de vaso largas Dr. 6PT/Dr. 6PT Deep Sockets: 6-13mm	1	4 124,93
		5) 1/4" Llaves de vaso Torx Dr./Dr. Star Sockets: E4, E5, E6, E7, E8		
		2) 1/2" Barras de extensión Dr./Dr. Extension Bars: 125 & 250mm		
		2) 1/2" Llaves de vaso para bujías Dr./Dr. Spark Plug Sockets: 16 & 21mm		
	1/2" Articulación universal Dr./Dr. Universal Joint			
	Adaptador/Adapter 3/8" (F) x 1/2" (M)			
	Adaptador para puntas/Bit Coupler: 1/2" (F) x 5/16" (F)			
	16) 5/16" Puntas/Bits:			
	4-Hex: 8, 10, 12, 14mm / 3-Slo: 8, 10, 12mm / 2-Ph: 3, 4			
	2-Poz: 3, 4 / 5-Torx: T40, T45, T50, T55, T60 (templados/tempered)			
	1/4" Mango de carraca Torx de liberación rápida/ Dr. Quick release ratchet handle, 24 dientes/teeth			
	1/2" Mango de carraca de liberación rápida/ Dr. Quick release ratchet handel, 24 dientes/teeth			
	Maletín moldeado por soplado/Blow Mould Case			

SETS HERRAMIENTAS 94 PCS / COFFRET D'OUTILS 94 PCS / 94 PCS TOOL SET  
SET ATTREZZATURA 94 PEZZI / CONJUNTO DE FERRAMENTAS 94 PÇS

94 pcs  
1/4" - 1/2"



380 x 270 x 80 mm

Ref				
1400 9011	18)	1/2" Llaves de vaso Dr. 6 caras/Dr. 6 Point Sockets: 10, 11, 12 13, 14, 15, 16, 17, 18, 19, 20, 21, 22, 23, 24, 27, 30, 32mm		
	4)	1/2" Llaves de vaso largas Dr./Dr. Deep Sockets (6pts): 14, 15, 17, 19mm		
	2)	1/4" Llaves de vaso para bujías Dr./Dr. Spark Plugs: 16 & 21mm		
	17)	1/4" puntas de destornillador Cr-V Dr./Dr. Cr-V Socket Bits:		
		4-Hex: 3, 4, 5, 6mm / 3-Planas/Slotted: 4, 5.5, 7mm / 2-Phillips: 1, 2		
		2-Pozi: 1, 2 / 6-Torx: T8, T10, T15, T20, T25, T30		
		1/2" Articulación universal Dr./Dr. Universal Joint		
	2)	1/2" Barras de extensión Dr./Dr. Extension Bars: 125 & 250mm		
	4)	Llaves Allen/Hex Key Wrenches: 1.27, 1.5, 2, 2.5mm		
	13)	1/4" Llaves de vaso 6 caras Dr./Dr. 6 Point Sockets: 4, 4.5, 5, 5.5, 6, 7, 8, 9, 10, 11, 12, 13, 14mm		
	8)	1/4" Llaves de vaso largas (6 caras) Dr./Dr. Deep Sockets (6pts): 6, 7, 8, 9, 10, 11, 12, 13mm		
		1/4" Articulación universal Dr./Dr. Universal Joint	1	4 108,51
	15)	5/16" Puntas de destornillador Cr-V Dr./Dr. Cr-V Socket Bits:		
		4-Hex: 8, 10, 12, 14mm / 3-Pl/Slo: 8, 10, 12mm / 2-Ph: 3, 4		
		2-Poz: 3, 4 / 5-Torx: T40, T45, T50, T55		
		1/4" Destornillador porta-vasos Dr./Dr. Spinner Handle, go through type		
	1/4" Barra deslizante en T Dr./Dr. Sliding T-bar			
	1/4" Adaptador para llaves de vaso Dr./Dr. Socket Adaptor			
2)	1/4" Barras de extensión Dr./Dr. Ext. Bars: 50 & 100 mm			
	1/4" Barra de extensión flexible Dr./Dr. Flex Drive Extension Bar			
	Destornillador porta-vasos con Go-through/Go through spinner handle			
	1/4" Mango de carraca Torx de liberación rápida/ Dr. Quick release ratchet handle, 24 dientes/teeth			
	1/2" Mango de carraca Torx de liberación rápida/ Dr. Quick release ratchet handel, 24 dientes/teeth			
	Maletín moldeado por soplado/Blow Mold Case			



SETS 14 UDS. BOCAS Y CARRACA 3/4" / 14 PCS DOUILLES ET CLIQUET 3/4" / 14 PCS OF SOCKETS AND RATCHET 3/4"  
14 PEZZI BUSSOLE E CHIAVE A CRICCHETTO 3/4" / CONJUNTO DE 14 PÇS SOQUETES E ROQUETE DE 3/4"

3/4"



Ref	↓	🔑	3/4"	3/4"	L - 10,2 cm	L - 20,3 cm	📦	📦
0951 8008	22-24-27-30-32-36-38-41-46-50 mm	3/4"	1	1	1	1	1	373,56
0951 8009	7/8" - 15/16" - 1" - 1"1/8 - 1"1/4 - 1"7/16 - 1"1/2 - 1"5/8 - 1"3/4 - 2"	3/4"	1	1	1	1	1	365,56

SETS 15 UDS. BOCAS Y CARRACA 1" / 15 PCS DOUILLES ET CLIQUET 1" / 15 PCS OF SOCKETS AND RATCHET 1"  
15 PEZZI BUSSOLE E CHIAVE A CRICCHETTO 1" / CONJUNTO DE 15 PÇS SOQUETES E ROQUETE DE 1"

1"



Ref	↓	🔑	1"	1"	20,3 cm	40,6 cm	📦	📦
0951 8010	36-41-46-50-55-60-65-70-75-80 mm	1"	1	1	1	1	1	674,05
0951 8011	1"13/16 - 1"7/8 - 2" - 2"3/16 - 2"1/4 - 2"3/8 - 2"1/2 - 2"5/8 - 2"3/4 - 3" 1/8	1"	1	1	1	1	1	1.228,40

MALETÍN 36 PCS PROFESIONAL VASOS / MALETTE 36 PCS PROFESSIONNELLE DOUILLES / 36PCS PROFESSIONAL SOCKET SET  
VALIGETTA 36 PZ PROFESSIONALE, BUSSOLE / MALA 36 PÇS PROFISSIONAL SOQUETES

36 pcs  
1/4"



Calidad profesional. / Qualité professionnelle. / Professional quality. / Qualità professionale. / Qualidade profissional.

Ref	↓	🔑	📦	📦	📦	📦
1400 9023	1 Carraca/Ratchet 1/4"					
	10 uds vasos/sockets 1/4" 4mm ~ 13mm					
	6 Vasos largos/Deep Sockets 6mm ~ 13mm					
	11 Puntas destornillador/Assorted Size Screwdriver Bits 1/4"					
	1 Adap. puntas/bits					
	2 Barra extensión/Extension Bars 1/4"	36 pcs	1	12	44,90	
	1 Articulación universal/Bit adaptor					
	1 Adap. puntas/bits 3/8" (F) x 1/4" (M)					
	3 llaves hexagonales/Hex Key Wrenches					
	1 Maletín cierre metal/Blow Mold Case with Metal lock					

MALETÍN 57 PCS PROFESIONAL VASOS Y PUNTAS / MALETTE 57 PCS PROFESSIONNELLE DOUILLES ET POINTES / 57 PCS SOCKET WRENCH SET  
VALIGETTA 57 PZ PROFESSIONALE, BUSSOLE E PUNTE / MALA 57 PÇS PROFISSIONAL SOQUETES E PONTAS

57 pcs  
1/4"



Ref	↓	🔑	📦	📦	📦	📦
1400 9024	13 Vasos/Sockets 1/4": 4 - 4,5 - 5 - 5,5 - 6 - 7 - 8 - 9 - 10 - 11 - 12 - 13 - 14 mm					
	8 Vasos largos/Deep sockets 1/4": 6 - 7 - 8 - 9 - 10 - 11 - 12 - 13 mm					
	5 Vasos Torx/Star sockets 1/4": E4 - 5 - 6 - 7 - 8 mm					
	22 Vasos con puntas/Bit sockets 1/4": PH1 - 2 - 3 // PZ1 - 2 - 3					
	HX3 - 4 - 5 - 6 // FD4 - 5 - 5,5 - 6					
	T8 - T9 - T10 - T15 - T20 - T25 - T27 - T30	57 pcs	1	10	56,90	
	1 Carraca/Ratchet 1/4"					
	1 Barra extensión/Extension Bars 1/4" x 50-100 mm					
	1 Articulación universal/Universal joint 1/4"					
	1 Maneral/Sliding T 1/4"					
	1 Destornillador para vasos/Spinner Handel, Go Through Type 1/4"					
	3 llaves hexagonales/Hex Key Wrenches 1,5 - 2 - 2,5 mm					
	1 Maletín cierre metal/Blow Mold Case with Metal lock					





**JUEGOS DE HERRAMIENTAS / KITS D'OUTILS À MAIN / HAND TOOL KITS  
KIT STRUMENTI A MANO / JOGOS DE FERRAMENTAS**



SET PUNTAS + ADAPTADOR 27 PCS / KIT POINTES + ADAPTATEUR 27 PCS / BITS + ADAPTER 27 PCS  
SET PUNTE + ADATTATORE 27 PCS / JOGO DE PONTAS + ADAPTADOR 27 PÇS



Ref					
1400 9031	PH, PZ, TORX, SL, HEX	27 pcs	1	29,05	✓

SET PUNTAS + ADAPTADOR 15 PCS / KIT POINTES + ADAPTATEUR 15 PCS / BITS + ADAPTER 15 PCS  
SET PUNTE + ADATTATORE 15 PCS / JOGO DE PONTAS + ADAPTADOR 15 PÇS



Ref					
1400 9032	PH, PZ, TORX, SL	15 pcs	1	18,50	✓

SET MINI CARRACA 1/4" CON PUNTAS / SET MINI CLIQUET POINTES 1/4" / MINI RATCHET SET BITS 1/4"  
SET MINI CRICCHETTO - PUNTE 1/4" / MINI MALA C/ROQUETE E BIT 'S



Ref				
1400 9020	SLOTTED 5	23 pcs	1	33,50
	PH 1 - PH 2			
	Torx 10 - Torx 25			
	Hex 1,5 - Hex 2 - Hex 2,5 - Hex 3 - Hex 4 - Hex 5 - Hex 6 - Hex 8			
	1 Adap. vasos/sockets 1/4"			
	1 Adap. puntas/bits 1/4" - 3/8"			
	1 Carraca/Ratchet			
5 uds vasos/sockets 1/4" (8 - 9 - 10 - 13 - 14)				
2 uds vasos/sockets 3/8" (15 - 16)				

SET MINI CARRACA, VASOS Y PUNTAS / SET MINI CLIQUET, DOUILLES ET POINTES / MINI RATCHET, SOCKETS AND BITS SET  
SET MINI CRICCHETTI, BUSSOLE E PUNTE / CONJUNTO MINI CARRACA, SOQUETES E PONTAS



Ref				
1400 9021	PZ 1 (x2) - PZ 2 (x2) - PZ 3 (x2)	33 pcs	1	35,70
	PH 1 - PH 2 (x2) - PH3			
	TORX 10 (x2) - T15 (x3) - T20 (x2) - T25 (x3) - T30 (x2) - T40 (x2)			
	Hex 4 - Hex 5 - Hex 6			
	SLOTTED 5,5 - 6 - 8			
	1 Adap. puntas/bits 25mm			
	1 Adap. vasos/sockets 1/4"			
1 Carraca/Ratchet				

EXPOSITOR 8 MALETINES MINI / PRESENTOIR 8 VALISETTES / DISPLAY STAND WITH 8 MINI KITS  
ESPOSITORE CON 8 MINI VALIGETTE / EXPOSITOR PARA 8 MINI MALETAS



CONTENIDO / CONTENT

Ref		M		
1400 9020	245,60	1/4"	4 uds	1
1400 9021		1/4"	4 uds	1



PLANO 1/4" / SLOTTED 1/4"

1/4"



Ref	MODEL 1/4"	↔	📦	📊	📄	Ref	MODEL 1/4"	↔	📦	📊	📄
0956 0001	P- 3x0,5	25 mm	10	1,61	✓	0956 0009	P-5,5x1	25 mm	10	1,61	✓
0956 0002	P- 3x0,5	50 mm	5	3,64	✓	0956 0010	P-5,5x1	50 mm	5	3,64	✓
0956 0003	P-4x0,5	25 mm	10	1,61	✓	0956 0011	P-6,5x1,2	25 mm	10	1,61	✓
0956 0004	P-4x0,5	50 mm	5	3,64	✓	0956 0012	P-6,5x1,2	50 mm	5	3,64	✓
0956 0005	P-4,5x0,6	25 mm	10	1,61	✓	0956 0013	P-8x1,2	25 mm	10	5,77	✓
0956 0006	P-4,5x0,6	50 mm	5	3,64	✓	0956 0014	P-8x1,2	50 mm	5	5,90	✓
0956 0007	P-5,5x0,8	25 mm	10	1,61	✓	0956 0015	P-8x1,6	25 mm	10	5,72	✓
0956 0008	P-5,5x0,8	50 mm	5	3,64	✓	0956 0016	P-8x1,6	50 mm	5	6,24	✓

ROBERTSON 1/4"

1/4"



Ref	MODEL 1/4"	↔	📦	📊	📄
0957 0001	R-1	25 mm	5	2,08	✓
0957 0002	R-1	50 mm	5	4,32	✓
0957 0003	R-2	25 mm	5	1,92	✓
0957 0004	R-2	50 mm	5	4,68	✓
0957 0005	R-3	25 mm	5	1,92	✓
0957 0006	R-3	50 mm	5	4,32	✓

HEXAGONAL 1/4"

1/4"



Ref	MODEL 1/4"	↔	📦	📊	📄	Ref	MODEL 1/4"	↔	📦	📊	📄
0958 0001	2	25 mm	10	1,61	✓	0958 0008	4	50 mm	5	3,22	✓
0958 0002	2	50 mm	5	3,22	✓	0958 0009	5	25 mm	10	1,60	✓
0958 0003	2,5	25 mm	10	1,61	✓	0958 0010	5	50 mm	5	3,22	✓
0958 0004	2,5	50 mm	5	3,22	✓	0958 0011	6	25 mm	10	1,61	✓
0958 0005	3	25 mm	10	1,61	✓	0958 0012	6	50 mm	5	3,22	✓
0958 0006	3	50 mm	5	3,22	✓	0958 0013	8	25 mm	10	3,64	✓
0958 0007	4	25 mm	10	1,61	✓	0958 0014	10	25 mm	10	3,69	✓

HEXAGONAL INVIOLEABLE / PINTE TOURNEVIS HEXAG. INVIOLEABLE / BIT STANDARD HEX INVIOLEABLE / PUNTA ESAGON.INVIOLEABLE / BIT ALLEN

1/4"



Ref	MODEL 1/4"	↔	📦	📊	📄
0959 0003	3 INVIOLEABLE	25 mm	5	3,82	✓
0959 0004	4 INVIOLEABLE	25 mm	5	3,85	✓
0959 0005	5 INVIOLEABLE	25 mm	5	3,85	✓
0959 0006	6 INVIOLEABLE	25 mm	5	3,82	✓

POZIDRIVE 1/4"

1/4"

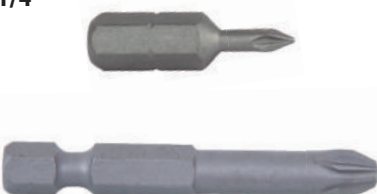

Ref	MODEL 1/4"	↔	📦	📊	📄
0952 0100	PZ-0	25 mm	10	1,50	✓
0952 0101	PZ-1	25 mm	10	1,04	✓
0952 0111	PZ-1	50 mm	5	2,10	✓
0952 0102	PZ-2	25 mm	10	1,04	✓
0952 0112	PZ-2	50 mm	5	2,10	✓
0952 0103	PZ-3	25 mm	10	1,04	✓
0952 0113	PZ-3	50 mm	5	2,10	✓
0952 0104	PZ-4	32 mm	10	3,64	✓



PHILLIPS



1/4"



Ref	MODEL 1/4"	↔			
0953 0100	PH-0	25 mm	10	1,50	✓
0953 0101	PH-1	25 mm	10	1,04	✓
0953 0111	PH-1	50 mm	5	2,10	✓
0953 0102	PH-2	25 mm	10	1,04	✓
0953 0112	PH-2	50 mm	5	2,10	✓
0953 0103	PH-3	25 mm	10	1,04	✓
0953 0113	PH-3	50 mm	5	2,10	✓
0953 0104	PH-4	32 mm	10	3,64	✓

TORX



1/4"



Ref	MODEL 1/4"	↔				Ref	MODEL 1/4"	↔			
0954 0106	T-6	25 mm	10	2,60	✓	0954 0220	T-20	50 mm	5	5,72	✓
0954 0107	T-7	25 mm	10	2,60	✓	0954 0125	T-25	25 mm	10	1,95	✓
0954 0108	T-8	25 mm	10	2,34	✓	0954 0225	T-25	50 mm	5	5,72	✓
0954 0109	T-9	25 mm	10	2,34	✓	0954 0127	T-27	25 mm	10	1,95	✓
0954 0110	T-10	25 mm	10	1,95	✓	0954 0227	T-27	50 mm	5	5,72	✓
0954 0210	T-10	50 mm	5	5,72	✓	0954 0130	T-30	25 mm	10	1,95	✓
0954 0115	T-15	25 mm	10	1,95	✓	0954 0230	T-30	50 mm	5	5,72	✓
0954 0215	T-15	50 mm	5	5,72	✓	0954 0140	T-40	25 mm	10	1,95	✓
0954 0120	T-20	25 mm	10	1,95	✓	0954 0240	T-40	50 mm	5	5,72	✓

TORX INVIOLEBLE / TORX INVIOLEBLE / TAMPER RESISTANCE TORX / TORX INVIOLEBLE / TORX COM FURO



1/4"



Ref	MODEL 1/4"	↔			
0954 1010	T-10 INVIOLEBLE	25 mm	10	3,50	✓
0954 1015	T-15 INVIOLEBLE	25 mm	10	3,50	✓
0954 1020	T-20 INVIOLEBLE	25 mm	10	3,50	✓
0954 1025	T-25 INVIOLEBLE	25 mm	10	3,50	✓
0954 1027	T-27 INVIOLEBLE	25 mm	10	3,50	✓
0954 1030	T-30 INVIOLEBLE	25 mm	10	3,50	✓
0954 1040	T-40 INVIOLEBLE	25 mm	10	3,50	✓

T.WING - T-SET - XZN EXTRA



1/4"

T.WING



Ref	MODEL 1/4"	↔			
0959 1001	1	25 mm	10	3,90	✓
0959 1002	2	25 mm	10	3,90	✓
0959 1003	3	25 mm	10	3,90	✓
0959 1004	4	25 mm	10	3,90	✓
0959 1005	5	25 mm	10	3,90	✓
0959 1006	6	25 mm	10	6,24	✓



1/4"

T-SET



Ref	MODEL 1/4"	↔			
0959 2001	2	25 mm	10	3,95	✓
0959 2002	3	25 mm	10	3,95	✓
0959 2003	4	25 mm	10	3,95	✓
0959 2004	5	25 mm	10	3,95	✓
0959 2005	6	25 mm	10	3,95	✓
0959 2006	8	25 mm	10	3,95	✓



1/4"

XZN EXTRA



Ref	MODEL 1/4"	↔			
0959 3001	M-4	25 mm	10	5,35	✓
0959 3002	M-5	25 mm	10	5,35	✓
0959 3003	M-6	25 mm	10	5,35	✓
0959 3004	M-8	25 mm	10	6,76	✓
0959 3005	M-10	25 mm	10	8,22	✓





TITANIO / TITANE / TITANIUM / TITANIO / TITANIUM



1/4"

POZIDRIVE



Ref	MODEL 1/4"	↔	📦	📊	📄
0952 0001	PZ - 1	25 mm	10	2,68	✓
0952 0002	PZ - 1	50 mm	5	4,46	✓
0952 0003	PZ - 2	25 mm	10	2,68	✓
0952 0004	PZ - 2	50 mm	5	4,46	✓
0952 0005	PZ - 3	25 mm	10	2,68	✓
0952 0006	PZ - 3	50 mm	5	4,46	✓



1/4"

PHILLIPS



Ref	MODEL 1/4"	↔	📦	📊	📄
0953 0001	PH - 1	25 mm	10	2,68	✓
0953 0002	PH - 1	50 mm	5	4,46	✓
0953 0003	PH - 2	25 mm	10	2,68	✓
0953 0004	PH - 2	50 mm	5	4,46	✓
0953 0005	PH - 3	25 mm	10	2,68	✓
0953 0006	PH - 3	50 mm	5	4,38	✓



1/4"

TORX



Ref	MODEL 1/4"	↔	📦	📊	📄
0954 0001	T-10	25 mm	5	3,85	✓
0954 0002	T-15	25 mm	5	3,85	✓
0954 0003	T-20	25 mm	5	3,85	✓
0954 0004	T-25	25 mm	5	3,85	✓
0954 0005	T-27	25 mm	5	3,85	✓
0954 0006	T-30	25 mm	5	3,85	✓
0954 0007	T-40	25 mm	5	3,85	✓

SET 2 PUNTAS 1/4" CON MAGNETISMO PH-2 / SET 2 POINTES 1/4 "AVEC MAGNÉTISME PH-2 / 2-BIT SET 1/4" WITH MAGNETIC HOLDER PH-2  
SET 2 PUNTE (PH-2) 1/4" CON MAGNETE / JOGO 2 BROCAS 1/4" COM MAGNETISMO PH-2



1/4"

PHILLIPS



ES Puntas para destornillador 1/4" con punta modelo PH2 de 50 mm de longitud fabricadas en acero. Incluye corona magnética pra evitar la caída de las tornillos y función limitador/ tope de profundidad para dejar perfectamente enrasado el tornillo sin deformar la superficie.

FR Pointes pour tournevis 1/4 avec pointe modèle PH2 de 50mm de longueur fabriquées en acier. Inclut couronne magnétique pour éviter la chute les vis et la fonction limiteur/limite de profondeur pour laisser la vis parfaitement plate sans déformer la surface.

EN 1/4" 50mm-long screwdriver bits, PH2 model and made from steel. It includes a magnetic crown to avoid the falling of screws and a depth limiting/stop to adjust perfectly the screw into the surface without distorting it.

IT Punte a croce, mod. PH2, per cacciavite 1/4". Punte fabbricate in acciaio, 50mm di lunghezza. Dotate di corona magnetica per evitare la caduta delle viti e funzione di limitazione/arresto di profondità affinché le stesse entrino perfettamente nella superficie senza che si deformi.

PT Brocas ou pontas para chave de fendas 1/4" com ponta modelo PH2 de 50 mm de comprimento feitas de aço. Inclui coroa magnética para evitar a queda dos parafusos e função de limitador/tope de profundidade para deixar perfeitamente nivelado o parafuso sem deformar a superfície.

Ref	📦	↔	📦	📊	📄
0959 4009	2 x PH2	50 mm	1	30	5,15



**PUNTAS DE ATORNILLAR 1/4" / EMBOUTS POR VISSEUSES / SCREW BITS  
PUNTE PER AVVITATORI / BIT'S PARA PARAFUSAR**

KITS DE PUNTAS 1/4" / SETS DE EMBOUTS 1/4" / KITS OF 1/4" BITS / KIT PUNTE 1/4" / KIT DE PONTAS 1/4"

1/4"



Ref	↓	📦	📊	📄
0959 4001	PH 1, 2, 3 x 25 mm ADAPT. 10x60 mm	1	10,40	✓

1/4"



Ref	↓	📦	📊	📄
0959 4002	PH 1, 2, 3 x 25 mm ADAPT. 10x60 mm	1	16,25	✓

1/4"

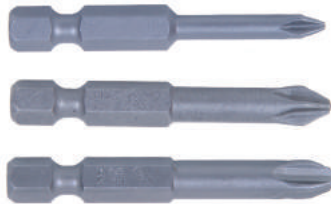

Ref	↓	📦	📊	📄
0959 4003	PH 1, 2, 3 x 50 mm	1	8,84	✓

1/4"

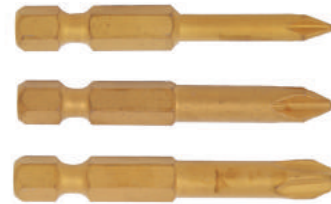

Ref	↓	📦	📊	📄
0959 4004	PH 1, 2, 3 x 50 mm	1	17,05	✓

1/4"



Ref	↓	📦	📊	📄
0959 4005	PZ 1, 2, 3 x 25 mm ADAPT. 10x60 mm	1	10,40	✓

1/4"



Ref	↓	📦	📊	📄
0959 4006	PZ 1, 2, 3 x 25 mm ADAPT. 10x60 mm	1	16,25	✓

1/4"

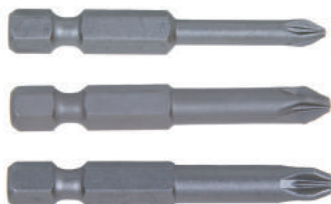

Ref	↓	📦	📊	📄
0959 4007	PZ 1, 2, 3 x 50 mm	1	8,84	✓

1/4"

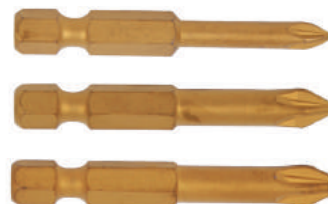

Ref	↓	📦	📊	📄
0959 4008	PZ 1, 2, 3 x 50 mm	1	17,16	✓



ADAPTADOR PARA TORNILLO HEXAGONAL IMANTADO / ADAPTATEUR POUR TOURNEVIS HEXAGONAL AVEC AIMANT  
MAGNETIC BIT HOLDER FOR HEXAGONAL SCREWS / ADATTATORE MAGNETICO PER VITI ESAGONALI  
ADAPTADOR PARA PARAFUSOS HEXAGONAL MAGNETIZADO



1/4"

Ref	SW				Ref	SW			
0952 0505	5 mm	1	9,57	✓	0952 0510	10 mm	1	10,56	✓
0952 0555	5,5 mm	1	9,57	✓	0952 0511	11 mm	1	11,44	✓
0952 0506	6 mm	1	9,98	✓	0952 0512	12 mm	1	11,44	✓
0952 0507	7 mm	1	9,98	✓	0952 0513	13 mm	1	12,27	✓
0952 0508	8 mm	1	9,98	✓					

PORTAPUNTAS SDS PLUS IMANTADO / ADAPTATEUR POINTES POUR VISSEUSES / MAGNETIC BIT HOLDER  
ADATTATORE PER PUNTE / PORTA-BITS MAGNETIZADO



SDS Plus

1/4"

Ref				
0952 9997	11x98 mm	17,90	1	✓

ADAPTADOR PUNTAS PARA TALADROS IMANTADO / ADAPTATEUR POINTES POUR VISSEUSES / MAGNETIC BIT HOLDER  
ADATTATORE MAGNETICO PER PUNTE / ADAPTADOR BITS PARA APARAFUSADORAS MAGNETIZADO



1/4"

1/4"

Ref				
0952 9998	11x75 mm	10,92	1	✓

PORTAPUNTAS DE CAMBIO RÁPIDO / ADAPTATEUR POINTES POUR VISSEUSES / BIT HOLDER QUICK GRIP  
ADATTATORE PORTAPUNTE, CAMBIO RAPIDO / PORTA-BITS DE ENGATE RÁPIDO



1/4"

1/4"

Ref				
0952 9999	1/4 x 77 mm	21,99	1	✓

ADAPTADORES DE CARRACA PARA PUNTAS DE 1/4" Y 5/16" / ADAPTATEUR POUR EMBOUTS DE 1/4" ET 5/16" / 1/4" AND 5/16" BIT ADAPTOR  
ADATTATORI PER PUNTE DA 1/4" E 5/16" / ADAPTADORES DE ROQUETE PARA BITS DE 1/4" E 5/16"

Bits 1/4"



Bits 5/16"



Ref			
1400 8198	1/2"	1	2,86
1400 8199	3/8"	1	2,60
1400 8200	1/4"	1	1,98

Ref			
1400 8195	1/2"	1	2,85
1400 8196	3/8"	1	1,60



PLANA / SLOTTED

5/16"



Ref	MODEL	↔			Ref	MODEL	↔		
1400 8025	SL-5	30 mm	5	0,93	1400 8028	SL-8	30 mm	5	0,70
1400 8055	SL-5	75 mm	5	1,14	1400 8058	SL-8	75 mm	5	1,14
1400 8026	SL-6	30 mm	5	0,70	1400 8029	SL-10	30 mm	5	1,00
1400 8056	SL-6	75 mm	5	1,14	1400 8059	SL-10	75 mm	5	1,57
1400 8027	SL-7	30 mm	5	0,70	1400 8030	SL-12	30 mm	5	1,22
1400 8057	SL-7	75 mm	5	1,14	1400 8060	SL-12	75 mm	5	1,57

PHILLIPS

5/16"



Ref	MODEL	↔		
1400 8001	PH-1	30 mm	5	0,70
1400 8031	PH-1	75 mm	5	1,14
1400 8002	PH-2	30 mm	5	0,83
1400 8032	PH-2	75 mm	5	1,14
1400 8003	PH-3	30 mm	5	0,70
1400 8033	PH-3	75 mm	5	1,30
1400 8004	PH-4	30 mm	5	0,70
1400 8034	PH-4	75 mm	5	1,14

POZIDRIVE

5/16"



Ref	MODEL	↔		
1400 8005	PZ-1	30 mm	5	0,70
1400 8035	PZ-1	75 mm	5	1,14
1400 8006	PZ-2	30 mm	5	0,73
1400 8036	PZ-2	75 mm	5	1,14
1400 8007	PZ-3	30 mm	5	0,70
1400 8037	PZ-3	75 mm	5	1,14
1400 8008	PZ-4	30 mm	5	0,73
1400 8038	PZ-4	75 mm	5	1,14

TORX

5/16"



Ref	MODEL	↔			Ref	MODEL	↔		
1400 8009	T-25	30 mm	5	0,70	1400 8013	T-45	30 mm	5	0,83
1400 8039	T-25	75 mm	5	1,14	1400 8043	T-45	75 mm	5	1,14
1400 8010	T-27	30 mm	5	0,70	1400 8014	T-50	30 mm	5	0,94
1400 8040	T-27	75 mm	5	1,14	1400 8044	T-50	75 mm	5	1,14
1400 8011	T-30	30 mm	5	0,73	1400 8015	T-55	30 mm	5	1,10
1400 8041	T-30	75 mm	5	1,14	1400 8045	T-55	75 mm	5	2,18
1400 8012	T-40	30 mm	5	0,88	1400 8016	T-60	30 mm	5	1,35
1400 8042	T-40	75 mm	5	1,14	1400 8046	T-60	75 mm	5	2,10

HEXAGONAL

5/16"



Ref	MODEL	↔			Ref	MODEL	↔		
1400 8017	H-3	30 mm	5	0,70	1400 8021	H-8	30 mm	5	0,73
1400 8047	H-3	75 mm	5	1,14	1400 8051	H-8	75 mm	5	1,14
1400 8018	H-4	30 mm	5	0,70	1400 8022	H-10	30 mm	5	1,02
1400 8048	H-4	75 mm	5	1,14	1400 8052	H-10	75 mm	5	1,74
1400 8019	H-5	30 mm	5	0,70	1400 8023	H-12	30 mm	5	1,15
1400 8049	H-5	75 mm	5	1,14	1400 8053	H-12	75 mm	5	1,97
1400 8020	H-6	30 mm	5	1,35	1400 8024	H-14	30 mm	5	1,79
1400 8050	H-6	75 mm	5	1,14	1400 8054	H-14	75 mm	5	3,61



MOD: CONFORT PLUS



ES Mango fabricado en material polipropileno. Equipado con mangos ergonómicos y antideslizantes, utilizando una materia prima no tóxica. Varilla fabricada en acero al cromo-molibdeno-vanadio. Permite aprietes un 30% superior a los destornilladores estándar. Todos los procesos de fabricación siguen la norma ISO 9002 y DIN 5262 ó 2380.

FR Tournevis fabriqué en polypropylène, équipé de manches ergonomiques et antidérapants. Fabriqué en matière première non-toxique. Tige fabriquée en acier au chrome-molybdène-vanadium. Permet un serrage 30% supérieur à celui d'un tournevis standard. Tous les processus de fabrication répondent à la norme ISO 9002 et DIN 5262 ou 2380.

EN The handle is made of Polypropylene. Ergonomic and anti-slippery handles. There are used non-toxic raw materials. Blade made from Chrome molybdenum vanadium steel. 30% better tightening than traditional screwdrivers. All manufacturing operations meet ISO 9002 and DIN 5262 or 2380.

IT Impugnatura in polipropilene. Ergonomica e antiscivolo, realizzata con materie prime non tossiche. Cacciavite realizzato in acciaio Cromo Molibdeno Vanadio. Permette un serraggio il 30% superiore rispetto ai cacciaviti standard. Tutti i processi di fabbricazione sono in accordo con le norme ISO 9002 e DIN 5262 o 2380.

PT Punho fabricado em polipropileno, ergonômicos e anti-deslizantes utilizando uma matéria prima não tóxica. Haste fabricada em aço cromo-molibdênio-vanádio, permite apertos até 30% superiores às chaves de fendas standard. Todos os processos de fabricação seguem a norma ISO 9002 e DIN 5265 o 2380.



PLANO - MECÁNICO / MECANICIEN / MECHANIC / PER MECCANICI / MECÂNICO

DIN 2380



ES Punta antideslizante.  
 FR Pointe antidérapante.  
 EN Non-slip tip.  
 IT Punta antiscivolo.  
 PT Ponta anti-deslizante.



Ref	MODEL						
0950 6025	SL - 3	60 mm	132 mm	1	12	2,70	✓
0950 6026	SL - 4	80 mm	170 mm	1	12	3,06	✓
0950 6027	SL - 5,5	125 mm	215 mm	1	12	3,85	✓
0950 6028	SL - 6,5	100 mm	207 mm	1	12	3,95	✓
0950 6029	SL - 6,5	150 mm	257 mm	1	12	4,74	✓
0950 6030	SL - 8	150 mm	268 mm	1	12	4,89	✓
0950 6031	SL - 8	200 mm	318 mm	1	12	5,10	✓

PLANO - CON HEXÁGONO / AVEC HEXAGONE / WITH HEX WRENCH / CON ESAGONO / COM SEXTAVADO

DIN 2380



ES Punta antideslizante.  
 FR Pointe antidérapante.  
 EN Non-slip tip.  
 IT Punta antiscivolo.  
 PT Ponta anti-deslizante.



Ref	MODEL						
0950 6035	SL - 5,5	125 mm	215 mm	1	12	4,60	✓
0950 6036	SL - 6,5	100 mm	207 mm	1	12	4,47	✓
0950 6037	SL - 6,5	150 mm	257 mm	1	12	4,78	✓
0950 6038	SL - 8	150 mm	268 mm	1	12	5,98	✓
0950 6039	SL - 8	200 mm	318 mm	1	12	6,50	✓

PLANO-ELECTRICISTA / ELECTRICIEN / ELECTRICIAN / PER ELETTRICISTI / ELETRICISTA

DIN 2380-D



ES Punta antideslizante.  
 FR Pointe antidérapante.  
 EN Non-slip tip.  
 IT Punta antiscivolo.  
 PT Ponta anti-deslizante.



Ref	MODEL						
0950 6015	SL - 3	60 mm	132 mm	1	12	3,06	✓
0950 6016	SL - 4	80 mm	170 mm	1	12	3,31	✓
0950 6017	SL - 5	125 mm	215 mm	1	12	3,70	✓
0950 6018	SL - 6	150 mm	257 mm	1	12	4,37	✓
0950 6019	SL - 6	200 mm	307 mm	1	12	4,58	✓





TRIPLE ALETA / TRIPLE NAGEOIRE / TRI-WING / TRE PUNTE / TRIPARTIDA



Ref	MODEL						
0950 6090	TRI-WING 1	100 mm	172 mm	1	12	4,36	✓
0950 6091	TRI-WING 2	100 mm	172 mm	1	12	4,37	✓
0950 6092	TRI-WING 3	100 mm	190 mm	1	12	4,42	✓
0950 6093	TRI-WING 4	100 mm	190 mm	1	12	4,42	✓

POZIDRIVE

DIN ISO 8764



Ref	MODEL						
0950 6045	PZ - 0	60 mm	132 mm	1	12	2,91	✓
0950 6046	PZ - 1	80 mm	170 mm	1	12	3,22	✓
0950 6047	PZ - 2	100 mm	207 mm	1	12	4,10	✓
0950 6048	PZ - 3	150 mm	268 mm	1	12	5,36	✓

POZIDRIVE - CON HEXÁGONO / AVEC HEXAGONE / WITH HEX WRENCH / CON ESAGONO / COM SEXTAVADO

DIN ISO 8764-1



Ref	MODEL						
0950 6050	PZ - 1	80 mm	170 mm	1	12	3,99	✓
0950 6051	PZ - 2	100 mm	207 mm	1	12	4,76	✓
0950 6052	PZ - 3	125 mm	243 mm	1	12	6,06	✓
0950 6053	PZ - 3	150 mm	268 mm	1	12	6,08	✓

PHILLIPS

DIN ISO 5262



Ref	MODEL						
0950 6001	PH - 0	60 mm	132 mm	1	12	3,02	✓
0950 6002	PH - 1	80 mm	170 mm	1	12	3,31	✓
0950 6003	PH - 2	100 mm	207 mm	1	12	3,99	✓
0950 6004	PH - 2	150 mm	257 mm	1	12	4,35	✓
0950 6005	PH - 3	125 mm	243 mm	1	12	5,04	✓
0950 6006	PH - 3	150 mm	268 mm	1	12	5,36	✓

PHILLIPS - CON HEXÁGONO / AVEC HEXAGONE / WITH HEX WRENCH / CON ESAGONO / COM SEXTAVADO

DIN ISO 5262



Ref	MODEL						
0950 6010	PH - 1	80 mm	170 mm	1	12	3,85	✓
0950 6011	PH - 2	100 mm	207 mm	1	12	4,74	✓
0950 6012	PH - 3	125 mm	243 mm	1	12	6,29	✓





CARROCERO / TOM POUCE / STUBBY / CACCIAVITI NANI / CHAVE DE FENDA TOCO

DIN-5262/2380 ISO 8764-1



Ref	MODEL						
0950 6055	PH- 2 PHILLIPS	38 mm	92 mm	1	12	2,87	✓
0950 6056	SL- 6,5 PLANO	38 mm	92 mm	1	12	3,37	✓
0950 6057	PZ-2 POZIDRIVE	38 mm	92 mm	1	12	3,17	✓

TORX

DIN ISO 5262



Ref	MODEL						
0950 6060	T - 6	60 mm	132 mm	1	12	2,81	✓
0950 6061	T - 7	60 mm	132 mm	1	12	2,81	✓
0950 6062	T - 8	60 mm	132 mm	1	12	2,81	✓
0950 6063	T - 10	80 mm	170 mm	1	12	2,86	✓
0950 6064	T - 15	80 mm	170 mm	1	12	2,91	✓
0950 6065	T - 20	100 mm	207 mm	1	12	3,47	✓
0950 6066	T - 25	100 mm	207 mm	1	12	3,56	✓
0950 6067	T - 27	125 mm	232 mm	1	12	4,16	✓
0950 6068	T - 30	125 mm	243 mm	1	12	4,76	✓
0950 6069	T - 40	150 mm	268 mm	1	12	5,20	✓

TORX INVOLABLE / TORX INVOLABLE / TAMPER RESISTANCE TORX / TORX INVOLABILE / TORX COM FURO

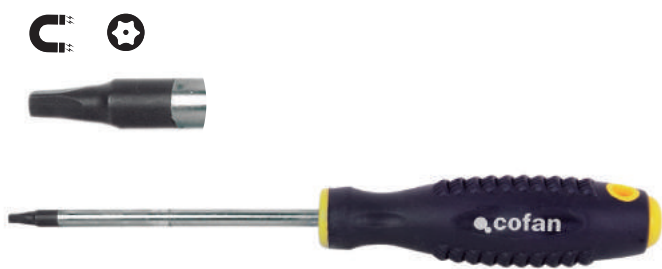

Ref	MODEL						
0950 6070	T - 6	60 mm	132 mm	1	12	3,02	✓
0950 6071	T - 7	60 mm	132 mm	1	12	3,02	✓
0950 6072	T - 8	60 mm	132 mm	1	12	3,02	✓
0950 6073	T - 10	80 mm	170 mm	1	12	3,28	✓
0950 6074	T - 15	80 mm	170 mm	1	12	3,90	✓
0950 6075	T - 20	100 mm	207 mm	1	12	4,07	✓
0950 6076	T - 25	100 mm	207 mm	1	12	4,11	✓
0950 6077	T - 30	125 mm	243 mm	1	12	5,03	✓
0950 6078	T - 40	150 mm	268 mm	1	12	5,51	✓

ALLEN - PUNTA BOLA / TETE SPHERIQUE / BALL TIP / TESTA SFERICA / PONTA ESFÉRICA



Ref	MODEL						
0950 6095	2,0	75 mm	147 mm	1	12	3,02	✓
0950 6096	2,5	100 mm	172 mm	1	12	3,74	✓
0950 6097	3,0	100 mm	172 mm	1	12	3,85	✓
0950 6098	4,0	100 mm	190 mm	1	12	4,11	✓
0950 6099	5,0	100 mm	190 mm	1	12	4,37	✓
0950 6100	6,0	125 mm	232 mm	1	12	4,78	✓
0950 6101	8,0	150 mm	268 mm	1	12	6,40	✓
0950 6102	10,0	200 mm	318 mm	1	12	7,64	✓

SPANNER

DIN ISO 5262



Ref	MODEL						
0950 6085	4	100 mm	172 mm	1	12	3,43	✓
0950 6086	6	100 mm	172 mm	1	12	3,43	✓
0950 6087	8	100 mm	190 mm	1	12	4,85	✓
0950 6088	10	100 mm	190 mm	1	12	4,85	✓



**MOD: CONFORT PLUS**  
**DESTORNILLADORES / TOURNEVIS / SCREWDRIVERS / CACCIAVITI / CHAVES DE FENDAS**



CR-MOLIBDENO CUADRADO R-2X100 / TOURNEVIS MAGNETIQUE R-2 / SQUARE SCREWDRIVER 2X100  
 CR-MOLIBDENO QUADRATO R-2X100 / ROBERTSON QUADRADA MOD"CONFORT" R 2X100



Ref	MODEL						
0950 6082	R - 2	100 mm	207 mm	1	12	3,85	✓

SETS FLEXIBLE CON VASOS DE 1/4" INCLUYE 9 VASOS (5-13 MM) / FLEXIBLE 1/4" INCLUT: 9 DOUILLES (5-13 MM)  
 FLEXIBLE 1/4" CONTAINS: 9 SOCKETS (5-13 MM) / FLESSIBILE 1/4" CONTIENE: 9 BUSSOLE (5-13 MM)  
 JOGO DE CHAVES DE FENDA FLEXÍVEL DE 1/4" INCLUI 9 SOQUETES (5-13 MM)



Ref	MODEL						
0950 6124	1/4"	150 mm	270 mm	1	12	14,82	✓

FLEXIBLE PARA VASOS DE 1/4" / FLEXIBLE POUR DOUILLES 1/4" / FLEXIBLE DRIVER FOR 1/4" SOCKETS  
 CACCIAVITE FLESSIBILE, BUSSOLE DA 1/4" / FLEXÍVEL PARA SOQUETES 1/4"



Ref	MODEL						
0950 6123	1/4"	150 mm	270 mm	1	12	8,22	✓

FLEXIBLE PARA PUNTAS 1/4" / FLEXIBLE DRIVER FOR 1/4" BITS / FLEXIBLE 1/4" BIT DRIVER  
 CACCIAVITE FLESSIBILE PER PUNTE DA 1/4" / FLEXÍVEL PARA PONTAS DE 1/4"



Ref	MODEL						
0950 6126	1/4"	150 mm	270 mm	1	12	8,27	✓

PORTA PUNTAS DE CAMBIO RÁPIDO 1/4" / TOURNEVIS PORTE-EMBOUITS 1/4" / 1/4" BIT QUICK-RELEASE CHUCK  
 CACCIAVITE PORTA INSERTI 1/4" / FLEXÍVEL PARA PONTAS TROCA RÁPIDA DE 1/4"



Ref	MODEL						
0950 6125	1/4"	125 mm	234 mm	1	12	8,27	✓



SET 8 PIEZAS - SET 6 PIEZAS / SET DE 8 PIÈCES - SET DE 6 PIÈCES / 8 PCS KIT - 6 PCS KIT  
 SET 8 PEZZI - SET 6 PEZZI / JOGO DE 8 PEÇAS - JOGO DE 6 PEÇAS

6 UNITS



Ref	↓	📦	📊	🚚
0950 6500	PH 1x80 - PH 2x100 - PH 3x125 SL 4x80 - SL 6,5x100 - SL 8x150	1	26,21	✓

8 UNITS



Ref	↓	📦	📊	🚚
0950 6501	PH 0x60 - PH 1x80 - PH 2x100 PH 2x150 - SL 3x60 - SL 5,5x125 SL 6,5x100 - SL 6,5x150	1	28,33	✓

SET 5 PIEZAS / SET DE 5 PIÈCES / 5 PCS KIT / SET 5 PEZZI / JOGO DE 5 PEÇAS



Ref	↓	📦	📊	🚚
0950 6502	PH 1x80 - PH 2x100 - SL 4,0x80 SL 5,5x125 - SL 6,5x150	1	17,16	

SET 6 PIEZAS / SET DE 6 PIÈCES / 6 PCS KIT / SET 6 PEZZI / JOGO DE 6 PEÇAS



Incluye display / Avec display / With display  
 Con display / Inclui display



Ref	↓	📦	📊	🚚
0950 6503	PH 1x80 - PH 2x100 - PH 3x125 SL 4x80 - SL 6,5x100 - SL 8x150	1	27,46	



**DESTORNILLADORES VASOS HEXAGONALES / TOURNEVIS POINTE HEXAGONALE / SCREWDRIVERS WITH HEX SOCKET**  
**CACCIAVITE BUSSOLA ESAGONALE / CHAVES DE FENDAS SOQUETE HEXAGONAL**



ES Destornilladores punta de vaso hexagonales con mango ergonómico y antideslizante. Punta magnética que evita caídas imprevistas y facilita el posicionamiento. Varilla de acero al carbono y vaso de cromo vanadio.

FR Tournevis pointe hexagonale avec manche ergonomique et antidérapant. Pointe magnétique qui évite des chutes inattendues et facilite le positionnement de l'outil. Tige d'acier au carbone et vase en chrome vanadium.

EN Screwdrivers with hexagonal socket and ergonomic non-slip handle. Magnetic tip that prevents sudden falls and facilitates positioning. Carbon steel rod and chrome vanadium steel socket.

IT Cacciavite con punta a bussola esagonale e manico ergonomico e antiscivolo. Punta magnetica che evita cadute impreviste e facilita il posizionamento.

PT Chaves de fenda com ponta de soquete hexagonal, com pega ergonômica e anti-deslizante. Ponta magnética evitando quedas imprevistas e facilita o posicionamento. Haste de aço de carbono e soquete de cromo vanádio.

Ref	↔	⊙	📦	📦	📦	📦
<b>0950 6105</b>	125 mm	SW 5	1	12	<b>8,74</b>	✓
<b>0950 6106</b>	125 mm	SW 6	1	12	<b>9,31</b>	✓
<b>0950 6107</b>	125 mm	SW 7	1	12	<b>9,58</b>	✓
<b>0950 6108</b>	125 mm	SW 8	1	12	<b>9,62</b>	✓
<b>0950 6109</b>	125 mm	SW 9	1	12	<b>9,94</b>	✓
<b>0950 6110</b>	125 mm	SW 10	1	12	<b>10,21</b>	✓
<b>0950 6111</b>	125 mm	SW 11	1	12	<b>10,76</b>	✓
<b>0950 6112</b>	125 mm	SW 12	1	12	<b>11,34</b>	✓
<b>0950 6113</b>	125 mm	SW 13	1	12	<b>11,70</b>	✓
<b>0950 6114</b>	125 mm	SW 14	1	12	<b>12,90</b>	✓

**DESTORNILLADORES VASO HEXAGONALES AISLADOS 1000V / TOURNEVIS ISOLÉS HEXAGONALE 1000V POUR DOUILLES**  
**ISOLATED SCREWDRIVERS 1000V WITH HEX SOCKET / CACCIAVITE CON BUSSOLA ESAGONALE ISOLATA 1000V**  
**CHAVES DE FENDA SOQUETE HEXAGONAL ISOLADO 1000V**



ES Destornilladores 1000V aislados con punta de vaso hexagonal, con mango ergonómico y antideslizante. Mango especial aislante con huellas de rotación que facilitan su uso a una mano.

FR Tournevis 1000V isolés pointe hexagonale, avec manche ergonomique et antidérapant. Manche spécial isolant avec des formes de rotation qui facilitent leur utilisation d'une seule main.

EN 1000V isolated screwdriver with hex socket, with ergonomic and non-slip handle. Special isolated handle with rotation marks that facilitate their use by only one hand.

IT Cacciavite isolato 1000V con punta a bussola esagonale, con manico ergonomico e antiscivolo. Manico speciale isolato e con impugnatura che ne facilita la rotazione con una sola mano.

PT Chaves de fenda 1000V isoladas com ponta de soquete hexagonal, com pega ergonômica e anti-deslizante. Pega especial isolante com aderência de rotação que facilita a sua utilização apenas com uma mão.

Ref	↔	⊙	📦	📦	📦	📦
<b>0950 8054</b>	125 mm	SW 4	1	12	<b>7,90</b>	✓
<b>0950 8055</b>	125 mm	SW 5	1	12	<b>8,27</b>	✓
<b>0950 8056</b>	125 mm	SW 6	1	12	<b>8,27</b>	✓
<b>0950 8057</b>	125 mm	SW 7	1	12	<b>8,27</b>	✓
<b>0950 8058</b>	125 mm	SW 8	1	12	<b>8,63</b>	✓
<b>0950 8059</b>	125 mm	SW 9	1	12	<b>8,84</b>	✓
<b>0950 8060</b>	125 mm	SW 10	1	12	<b>8,84</b>	✓
<b>0950 8061</b>	125 mm	SW 11	1	12	<b>9,29</b>	✓
<b>0950 8062</b>	125 mm	SW 12	1	12	<b>9,29</b>	✓
<b>0950 8063</b>	125 mm	SW 13	1	12	<b>10,24</b>	✓

**FLEXIBLE CON HEXÁGONO HEMBRA SW - 6, 7 Y 8 MM / FLEXIBLE HEXAGONAL FEMELLE SW - 6, 7 ET 8 MM**  
**FLEXIBLE WITH HEX WRENCH, FEMALE SW - 6, 7 AND 8 MM / CACCIAVITE FEMMINA FLESSIBILE CON ESAGONO SW - 6, 7 E 8 MM**  
**FLEXÍVEL COM HEXAGONO FÊMEA SW - 6,7 E 8 M**



Ref	SW	🔧	🔧	📦	📦	📦	📦
<b>0950 6120</b>	6 mm	150 mm	240 mm	1	12	<b>7,70</b>	✓
<b>0950 6121</b>	7 mm	150 mm	240 mm	1	12	<b>7,70</b>	✓
<b>0950 6122</b>	8 mm	150 mm	240 mm	1	12	<b>7,70</b>	✓



MOD: VICTORIA



ES Material: chrome molybdenum vanadium dureza: HRC 52° - 56°. Grip: Fabricado de ABS y neopreno, totalmente antideslizante, magnético.

FR Materiel: chrome molybdenum vanadium durezza: HRC 52° - 56°. Grip: Fabrique avec ABS et néoprène, totalement anti glissement, magnétique.

EN Material: chrome molybdenum vanadium. Hardness: HRC 52° - 56°. Grip: Made from ABS and neoprene, anti-sliding, magnetic tip.

IT Materiale: cromo molibdeno vanadio, durezza HRC 52°-56°. Impugnatura: Fabbricata in ABS e neoprene, tenuta antiscivolo.

PT Material :chrome molybdenum vanadium dureza: HRC 52 - 56 Punho: Fabricado de ABS e neopreno, totalmente antideslizante, ponta magnética.



ES ABS y neopreno.  
FR ABS et néoprène.  
EN ABS and neoprene.  
IT ABS e neoprene.  
PT ABS e neoprene.



ES Antideslizante.  
FR Antidérapant.  
EN Anti-Slippery.  
IT Antiscivolo.  
PT Antiderrapante.

PLANO / SLOTTED



Ref	MODEL				
0950 0030	SL 3 x 60 mm	1	12	2,91	✓
0950 0040	SL 4 x 80 mm	1	12	2,87	✓
0950 0055	SL 5.5 x 125 mm	1	12	3,45	✓
0950 0065	SL 6.5 x 150 mm	1	12	4,10	✓
0950 0080	SL 8 x 200 mm	1	12	5,60	✓

PHILLIPS



Ref	MODEL				
0950 1000	PH 0 x 60 mm	1	12	2,78	✓
0950 1001	PH 1 x 80 mm	1	12	3,02	✓
0950 1002	PH 2 x 100 mm	1	12	3,76	✓
0950 1003	PH 3 x 150 mm	1	12	4,86	✓

POZIDRIVE



Ref	MODEL				
0950 1200	PZ 0 x 60 mm	1	12	2,69	✓
0950 1201	PZ 1 x 80 mm	1	12	2,92	✓
0950 1202	PZ 2 x 100 mm	1	12	3,80	✓
0950 1203	PZ 3 x 150 mm	1	12	5,44	✓





TORX



Ref	MODEL				
0950 1708	TORX 8x60 mm	1	12	3,03	✓
0950 1709	TORX 9x60 mm	1	12	2,70	✓
0950 1710	TORX 10x80 mm	1	12	3,56	✓
0950 1715	TORX 15x80 mm	1	12	3,40	✓
0950 1720	TORX 20x100 mm	1	12	3,13	✓
0950 1725	TORX 25x100 mm	1	12	3,86	✓
0950 1730	TORX 30x125 mm	1	12	5,56	✓
0950 1740	TORX 40x150 mm	1	12	4,42	✓

EXPOSITOR DESTORNILLADORES 48 UDS. / PRESENTOIR TOURNEVIS "48 UNITES" / SCREWDRIVER DISPLAY STAND 48 PCS  
ESPOSITORE CACCIAVITI 48 PEZZI / EXPOSITOR DE CHAVES DE FENDAS 48 PEÇAS

DIN ISO - 2380



Ref	MODEL	Ref	MODEL				
0950 9011	●	0950 0030	SL 3 x 60 mm	6	1	238,26	
		0950 0055	SL 5,5 x 125 mm	6			
		0950 0065	SL 6,5 x 150 mm	6			
		0950 0080	SL 8 x 200 mm	6			
	⊕	0950 1000	PH - 0 mm	6			
		0950 1001	PH - 1 mm	6			
		0950 1002	PH - 2 mm	6			
		0950 1003	PH - 3 mm	6			

SET DESTORNILLADORES 5 PCS / SET DE 5 TOURNEVIS / SET OF 5 SCREWDRIVERS / SET DA 5 CACCIAVITI / JOGO DE CHAVES DE FENDA 5 PEÇAS



Ref	MODEL				
0950 9001	SET 5 pcs SL 4x8 - SL 5,5x125 PH-SL SL 6,5x150 - PH 1x80 - PH 2x100	1	16,79		
0950 9006	SET 5 pcs TORX T-10 - T-15 - T-20 - T-25 - T-30	1	20,95		

SET DESTORNILLADORES 7 PCS / SET DE 7 TOURNEVIS / SET OF 7 SCREWDRIVERS / SET DA 7CACCIAVITI / JOGO DE CHAVES DE FENDA 7 PEÇAS



Ref	MODEL				
0950 9003	7 pcs PH-SL SL 4x80 - SL 5,5x125 SL 6,5 x 150 - SL 8x200 PH 1x80 - PH 2x100 ; PH 3 x150	1	30,24		

DESTORNILLADOR PARA VASOS / TOURNEVIS POUR DOUILLES / SOCKET SCREWDRIVER / CACCIAVITE PER BOCCOLE / CHAVE DE FENDA PARA BITS



Ref			
0950 2005	1	6	6,14



SLOTTED - AISLADOS 1000 V / ISOLE 1000 V / ISOLATED 1000 V / ISOLATO 1000 V / FENDA-ISOLADA 1000 V



Ref	↔	⊖	⚙	📏	📦	📊	📄
0950 8001	75 mm	0,5 mm	2,4	1	16	3,64	✓
0950 8002	100 mm	0,8 mm	4	1	16	3,90	✓
0950 8003	125 mm	1 mm	5,5	1	8	4,68	✓
0950 8004	150 mm	1,2 mm	6,5	1	6	5,10	✓
0950 8005	175 mm	1,6 mm	8	1	6	6,40	✓

PHILLIPS - AISLADOS 1000 V / ISOLE 1000 V / ISOLATED 1000 V / ISOLATO 1000 V / ISOLADO 1000V



Ref	↔	⊕	📏	📦	📊	📄
0950 8006	60 mm	PH-0	1	12	3,64	✓
0950 8007	80 mm	PH-1	1	12	3,90	✓
0950 8008	100 mm	PH-2	1	12	4,89	✓
0950 8009	150 mm	PH-3	1	12	5,10	✓

POZIDRIVE - AISLADOS 1000 V / ISOLE 1000 V / ISOLATED 1000 V / ISOLATO 1000 V / ISOLADO 1000V



Ref	↔	⊕	📏	📦	📊	📄
0950 8010	60 mm	PZ-0	1	16	3,64	✓
0950 8011	80 mm	PZ-1	1	8	3,90	✓
0950 8012	100 mm	PZ-2	1	8	4,68	✓
0950 8013	150 mm	PZ-3	1	6	6,40	✓

SET 5 PCS 1000V / SET DE 5 UNITES 1000 V / SET OF 5 UNITS 1000 V / SET 5 PEZZI 1000 V / JOGO 5 PEÇAS 1000 V



Ref	📦	📊	📄
0950 9015	PH 1x80 - PH 2x100 - PZ 2x100 SL 4x100 - SL 6,5x150	1	22,36

EXPOSITOR DESTORNILLADORES 1000V - 48 UDS. / PRESENTOIR TOURNEVIS 1.000 V - 48 UNITES / 1000V SCREWDRIVER EXHIBITOR - 48 PCS  
 ESPOSITORE CACCIAVITI 1000V - 48 PEZZI / EXPOSITOR DE CHAVE DE FENDAS ISOLADAS 1000V - 48 PEÇAS



Ref	MODEL	Ref	MODEL	📦	📊	📄
0950 9012	⊖	0950 8001	SL 2,4 x 75 mm	1	239,41	✓
		0950 8002	SL 4 x 100 mm			
		0950 8003	SL 5,5 x 125 mm			
	0950 8004	SL 6,5 x 150 mm				
	0950 8006	PH - 0 mm				
	0950 8007	PH - 1 mm				
	0950 8008	PH - 2 mm				
	0950 8009	PH - 3 mm				
	0950 8009	PH - 3 mm	6			



# DESTORNILLADORES DE IMPACTO / TOURNEVIS A IMPACT / IMPACT SCREWDRIVERS CACCIAVITI AD IMPATTO / CHAVES DE FENDAS DE IMPACTO



## DESTORNILLADORES DE IMPACTO / TOURNEVIS A IMPACT / IMPACT SCREWDRIVERS CACCIAVITI AD IMPATTO / CHAVES DE FENDAS DE IMPACTO



ES Material: Cromo vanadio y varilla hexagonal de 3000 kg de resistencia. En la cabeza, hexágono para uso con llave.

FR Matériel: Chrome vanadium et tige hexagonale de 3000 kg de résistance. dans la tête hexagone pour utilisation avec clé.

EN Material: Chromium-vanadium and hexagonal bar up to 3000kg tensile strength. hexagonal head to use with a wrench.

IT Material: Cromo-vanádio e barra hexagonal de 3000 kg de resistência. cabeça hexagonal para uso com uma chave.

PT Material: Cromo vanadio e barra esagonale, resistencia fino a 3000kg. testa esagonale per utilizzo con chiave.

## PHILLIPS - DE IMPACTO / A IMPACT / IMPACT / AD IMPATTO / DE IMPACTO



Ref	MODEL				
0950 2501	PH 1x75	1	12	3,90	✓
0950 2502	PH 2x100	1	12	5,39	✓
0950 2503	PH 3x125	1	12	7,51	✓

## POZIDRIVE - DE IMPACTO / A IMPACT / IMPACT / AD IMPATTO / DE IMPACTO



Ref	MODEL				
0950 2513	PZ 1x75	1	12	3,95	✓
0950 2514	PZ 2x100	1	12	5,04	✓
0950 2515	PZ 3x125	1	12	7,58	✓

## PLANO DE IMPACTO / PLANO DE IMPACTO / IMPACT SLOTTED / CACCIAVITE PIATTO AD IMPATTO / FENDA DE IMPACTO



Ref	MODEL				
0950 2504	SL 4x75	1	12	4,78	✓
0950 2505	SL 5,5x100	1	12	4,15	✓
0950 2506	SL 6,5x125	1	12	6,12	✓
0950 2507	SL 6,5x150	1	12	6,45	✓
0950 2508	SL 8x150	1	12	7,70	✓
0950 2509	SL 8x200	1	12	8,22	✓
0950 2510	SL 9,5x175	1	12	8,67	✓
0950 2511	SL 9,5x200	1	12	9,13	✓
0950 2512	SL 9,5x250	1	12	9,46	✓

## EXPOSITOR DESTORNILLADOR IMPACTO - 45 UDS. / PRESENTOIR TOURNEVIS - 45 UNITES / IMPACT SCREWDRIVER EXHIBITOR - 45 UNITS ESPOSITORE CACCIAVITI - 45 PEZZI / EXPOSITOR DE CHAVES DE FENDAS DE IMPACTO - 45 PEÇAS



Ref			
0950 2600	45 uds	1	365,23

Ref	MODEL		Ref	MODEL	
9502501	PH 1x75	3	9502509	SL 8x200	3
9502502	PH 2x100	3	9502510	SL 9,5x175	3
9502503	PH 3x125	3	9502511	SL 9,5x200	3
9502504	SL 4x75	3	9502512	SL 9,5x250	3
9502505	SL 5,5x100	3	9502513	PZ 1x75	3
9502506	SL 6,5x125	3	9502514	PZ 2x100	3
9502507	SL 6,5x150	3	9502515	PZ 3x125	3
9502508	SL 8x150	3	EXPOSITOR6		1



PLANO DE ALTA PRECIÓN / PLAT DE HAUTE PRÉCISION / HIGH PRECISION SLOTTED  
CACCIAVITI PIATTI AD ALTA PRECISIONE / FENDA DE ALTA PRECIÃO



Ref	MODEL						
0950 7001	SL - 1,6	50 mm	148 mm	1	24	2,33	✓
0950 7002	SL - 2,0	50 mm	148 mm	1	24	2,42	✓
0950 7003	SL - 2,4	50 mm	148 mm	1	24	2,60	✓
0950 7004	SL - 2,4	75 mm	173 mm	1	24	2,81	✓
0950 7005	SL - 3,0	60 mm	158 mm	1	24	2,24	✓
0950 7006	SL - 3,0	100 mm	198 mm	1	24	2,50	✓

PHILLIPS - DE ALTA PRECIÓN / DE HAUTE PRÉCISION / HIGH PRECISION / AD ALTA PRECISIONE / DE ALTA PRECIÃO



Ref	MODEL						
0950 7010	PH - 00	50 mm	148 mm	1	24	2,12	✓
0950 7011	PH - 00	75 mm	173 mm	1	24	2,34	✓
0950 7012	PH - 0	50 mm	148 mm	1	24	2,03	✓
0950 7013	PH - 0	60 mm	158 mm	1	24	2,34	✓
0950 7014	PH - 0	100 mm	198 mm	1	24	2,55	✓
0950 7015	PH - 1	125 mm	223 mm	1	24	2,91	✓

POZIDRIVE - DE ALTA PRECIÓN / DE HAUTE PRÉCISION / HIGH PRECISION / AD ALTA PRECISIONE / DE ALTA PRECIÃO



Ref	MODEL						
0950 7020	PZ-0	50 mm	148 mm	1	24	2,24	✓
0950 7021	PZ-0	60 mm	158 mm	1	24	2,24	✓

TORX - DE ALTA PRECIÓN / DE HAUTE PRÉCISION / HIGH PRECISION / AD ALTA PRECISIONE / DE ALTA PRECIÃO



Ref	MODEL						
0950 7025	T-5	50 mm	148 mm	1	24	2,91	✓
0950 7026	T-6	50 mm	148 mm	1	24	2,91	✓
0950 7027	T-7	50 mm	148 mm	1	24	2,91	✓
0950 7028	T-8	50 mm	148 mm	1	24	2,91	✓
0950 7029	T-9	50 mm	148 mm	1	24	2,91	✓
0950 7030	T-10	50 mm	148 mm	1	24	2,91	✓
0950 7031	T-15	50 mm	148 mm	1	24	2,91	✓
0950 7032	T-20	50 mm	148 mm	1	24	2,91	✓

SET 7 PIEZAS DE ALTA PRECIÓN AISLADOS / SET 7 PIÈCES DE HAUTE PRÉCISION / KIT OF 7 HIGH PRECISION SCREWDRIVERS  
SET DA 7 PEZZI AD ALTA PRECISIONE / JOGO DE CHAVES DE ALTA PRECIÃO 7 PEÇAS



Ref						
0950 7099	PH 0x50 - PH 00x50	SL 1,6x50 - 2,0x50 - 2,4x50 - 2,4x75 - 3,0x60	1	16,86	✓	





**DESTORNILLADOR MANGO "T" / TOURNEVIS MANCHE "T" / "T" HANDLE SCREWDRIVERS  
CACCIAVITI IMPUGNATURA A "T" / CHAVE DE FENDAS COM CABO EM "T"**



DESTORNILLADORES MANGO EN "T" PUNTA ALLEN / TOURNEVIS MANCHE EN "T" EMBOUT ALLEN / "T" HANDLE, ALLEN TIP SCREWDRIVER  
CACCIAVITI IMPUGNATURA A "T" PUNTA ALLEN / CHAVE DE FENDAS COM CABO EM "T", PUNTA ALLEN



Ref	MODEL				
0950 1820	H - 2	1	12	3,48	✓
0950 1825	H - 2,5	1	12	4,19	✓
0950 1830	H - 3	1	12	3,95	✓
0950 1840	H - 4	1	12	4,24	✓
0950 1850	H - 5	1	12	5,30	✓
0950 1860	H - 6	1	12	5,46	✓
0950 1880	H - 8	1	12	7,21	✓

SET 7 PCS MANGO EN "T" PUNTA ALLEN / KIT 7 PCS TOURNEVIS MANCHE EN "T" EMBOUT ALLEN / "T" HANDLE, ALLEN TIP SCREWDRIVER 7 PCS SET  
SET CACCIAVITI A 7 PEZZI, IMPUGNATURA A "T", PUNTA ALLEN / JOGO DE 7 PEÇAS COM CABO EM "T", PUNTA ALLEN



Ref					
0950 9009	H-2; H-2,5; H-3; H-4; H-5; H-6; H-8	1	12	37,96	

DESTORNILLADORES MANGO EN "T" PUNTA TORX / TOURNEVIS MANCHE EN "T" EMBOUT TORX / "T" HANDLE, TORX TIP SCREWDRIVER  
CACCIAVITI CON MANICO A "T" PER VITI TORX / CHAVE DE FENDAS COM CABO EM "T", PUNTA TORX

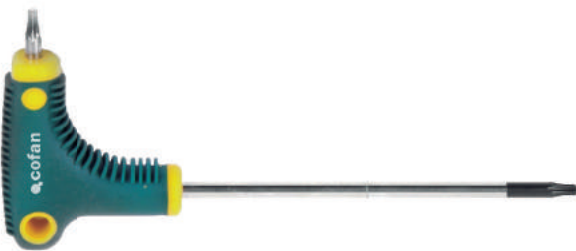

Ref	MODEL				
0950 1910	T-10	1	12	3,74	✓
0950 1915	T-15	1	12	4,66	✓
0950 1920	T-20	1	12	4,71	✓
0950 1925	T-25	1	12	4,07	✓
0950 1927	T-27	1	12	5,90	✓
0950 1930	T-30	1	12	5,16	✓
0950 1940	T-40	1	12	7,19	✓

DESTORNILLADORES MANGO EN "T" PUNTA TORX / TOURNEVIS MANCHE EN "T" EMBOUT TORX / "T" HANDLE, TORX TIP SCREWDRIVER  
CACCIAVITI CON MANICO A "T" PER VITI TORX / CHAVE DE FENDAS COM CABO EM "T", PUNTA TORX



Ref					
0950 9918	T-10; T-15; T-20; T-25; T-27; T-30; T-40	1	12	46,60	





MAGNETIZADOR - DESMAGNETIZADOR / BLOC À AIMANTER / MAGNETIZER - DEMAGNETIZER  
 MAGNETIZZATORE - SMAGNETIZZATORE / MAGNETIZADOR - DESMAGNITIZADOR



Ref			
0950 8018	1	12	7,99

DESTORNILLADOR PORTAPUNTAS VARILLA FLEXIBLE / TOURNEVIS PORTE POINTES TIGE FLEXIBLE / FLEXIBLE SHAFT RATCHET SCREWDRIVER  
 CACCIAVITE PORTAPUNTE CON ASTA FLESSIBILE / CHAVE DE FENDA CARREGADOR PONTAS HASTE FLEXÍVEL



Ref			
0952 9983	1	6	32,38

DESTORNILLADOR CON 6 PUNTAS LARGAS SURTIDAS / TOURNEVIS AVEC 6 LONGUES POINTES FOURNIES / SCREWDRIVER WITH 6 LONG BITS SUPPLIED  
 CACCIAVITE CON 6 PUNTE LUNGHE ASSORTITE / CHAVE DE FENDA COM 6 PONTAS COMPRIDAS SORTIDAS

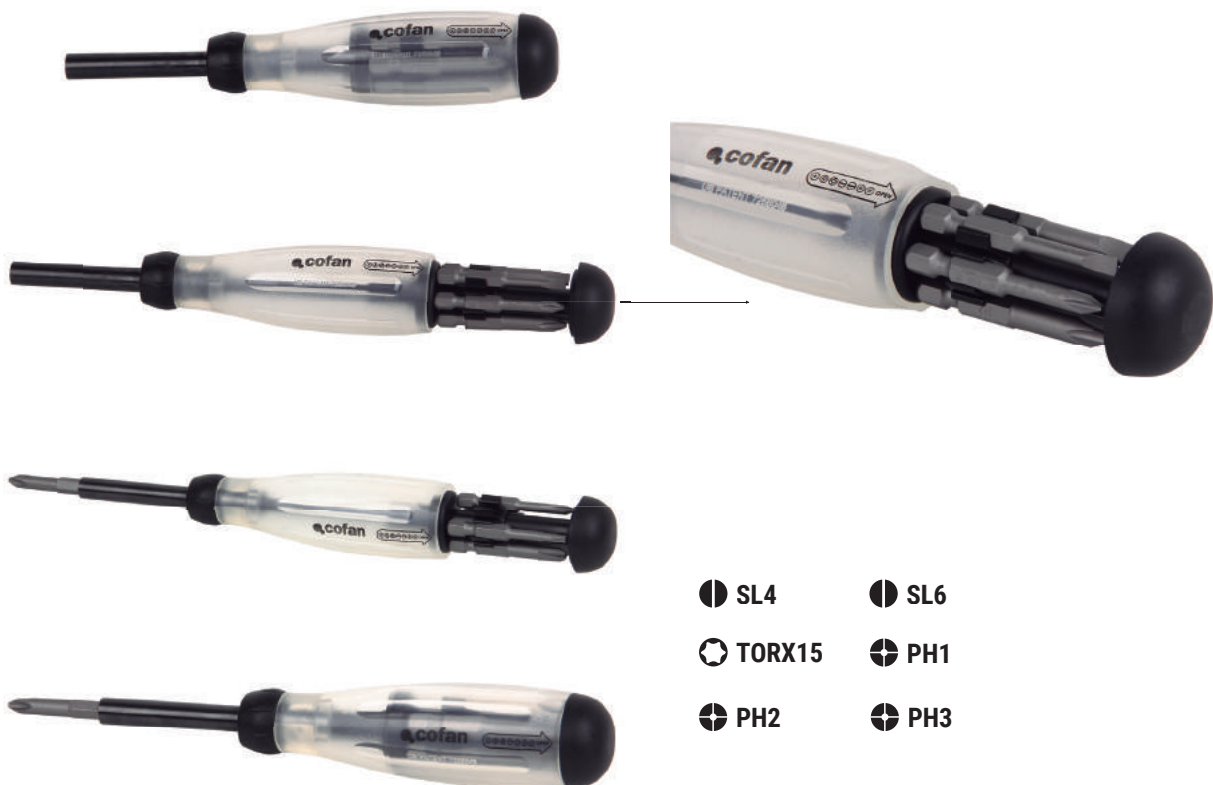

Ref			
0951 9985	1	6	22,78



SET DESTORNILLADOR EN "T" CON CARRACA / SET TOURNEVIS EN "T" AVEC CLIQUET / "T" SCREWDRIVER SET WITH RATCHET  
SET DI CACCIAVITI IN "T" CON SONAGLIO / JOGO CHAVES EM "T"



# 26 pcs

**HRC 51-54**

**Cr/V 6150**

SW 5 mm - 6 mm - 7 mm - 8 mm - 9 mm - 10 mm

**Cr/V**

- SL3   ● SL4   ● SL5   ● SL6
- ⊕ PH0   ⊕ PH1   ⊕ PH2   ⊕ PH3
- ⊗ T10   ⊗ T15

Ref			
0952 9984	1	6	20,28

SET DESTORN. CARRACA "T" CONVERTER VELOCIDAD 5:1 / SET TOURNEVIS CLIQUET "T" CONVERTER "5:1 VITESSES"  
SCREWDRIVER SET "T" RATCHET CONVERTER "5:1-GEAR SPEED" / SET DI CACCIAVITI CARRACA "T" CONVERTITORI "5:1 VELOCITA"  
JOGO CHAVES EM "T" CONVERTER "5:1 VELOCIDADES"



# 19 pcs

## VELOCIDAD 5:1

**Cr/V**

- SL3   ● SL4   ● SL5   ● SL6
- PH3
- ⊕ PH0   ⊕ PH1   ⊕ PH2   ⊕ T25   ⊗ T27   ⊗ T30
- ⊗ T10   ⊗ T15   ⊗ T20   ⊗ PZ3   ⊕ PZ2   ⊕ PZ2
- ⊕ PZ0   ⊕ PZ1   ⊕ PZ2   ⊕

Ref			
0952 9986	1	6	25,64



DESTORNILLADOR REVERSIBLE CORTO / TOURNEVIS REVERSIBLES COURT / SHORT REVERSIBLE SCREWDRIVER  
CACCIAVITI REVERSIBILI CORTI / CHAVE DE FENDA CURTA REVERSÍVEL



Ref						
0950 0002	6 x 38 mm	PH - SL	1	12	3,48	✓

DESTORNILLADOR REVERSIBLE / TOURNEVIS REVERSIBLES / REVERSIBLE SCREWDRIVER / CACCIAVITI REVERSIBILI / CHAVE DE FENDA REVERSÍVEL



Ref						
0950 0001	6 x 100 mm	PH - SL	1	12	4,84	✓

BUSCAPOLOS / TESTEUR DE COURANT / VOLTAGE TESTER / CERCAFASE / BUSCA-PÓLOS

BUSCAPOLOS / TESTEUR DE COURANT / VOLTAGE TESTER / CERCAFASE / BUSCA-PÓLOS



Ref					
0950 8022	100-250 V	150 mm	1	6	4,89
0950 8023	100-250 V	190 mm	1	6	6,47

BUSCAPOLOS DIGITAL / TESTEUR DE COURANT DIGITAL / DIGITAL VOLTAGE TESTER / CERCAFASE DIGITALE / BUSCA-PÓLOS DIGITAL



Ref				
0950 8024	0-220 AC/DC	1	6	9,64

BUSCAPOLOS / TESTEUR DE COURANT / VOLTAGE TESTER / CERCAFASE / BUSCA-PÓLOS



Ref					
0950 8016	100-250 V	140 mm	1	12	5,13
0950 8017	100-250 V	190 mm	1	12	6,89



TÉSTER ELECTRÓNICO MEDIDOR DE TENSION 2 EN 1 / TESTEUR ELECTRONIQUE A MESURE DE TENSION 2 EN 1 / ELECTRONIC TESTER 2 IN 1  
TESTER ELETTRONICO MISURA TENSIONE 2 IN 1 / DETECTOR ELETRÔNICO DE TENSÃO 2 EM 1



<b>Ref</b>				
0950 8025	3-400 V	1	6	16,57

**ALICATES CRIMPAR / PINCE A SERTIR / CRIMPING PLIERS  
PINZE TERMINALI CAVI / ALICATES CRIMPADORES**

ALICATES DE CRIMPAR PARA TERMINALES AISLADOS / PINCES A SERTIR LES COSSES / CRIMPING PLIERS  
PINZA TERMINALI CAVI / ALICATES DE CRIMPAR PARA TERMINAIS ISOLADOS

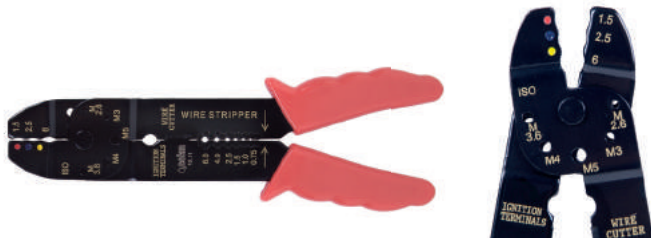

<b>Ref</b>					
0950 8020	0,75 - 6 mm	200 mm	1	6	13,85

ALICATES DE CRIMPAR PARA TERMINALES AISLADOS Y TERMINALES ESTAÑADOS / PINCES A SERTIR LES COSSES  
CRIMPING PLIERS / PINZA TERMINALI CAVI / ALICATE PARA TERMINAIS ISOLADOS E TERMINAIS ESTANHADOS



<b>Ref</b>					
0950 8021	0,75 - 6 mm	200 mm	1	6	14,40

PELACABLES MULTIFUNCIÓN (0,8-2,6) / PELE CABLES MULTIFUNCIÓN / MULTI-FUNCTION WIRE STRIPPER  
PELACAVI MULTIFUNZIONE / ALICATE PARA DECAPAR MULTI-FUNÇÃO



<b>Ref</b>				
0950 8029	0,8 - 2,6 mm	1	6	48,60



ALICATES UNIVERSALES / PINCE UNIVERSELLE / UNIVERSAL PLIERS / PINZE UNIVERSALI / ALICATES UNIVERSAIS



Ref					
0960 0017	6" 160 mm	1	6	11,91	✓
0960 0018	7" 180 mm	1	6	14,77	✓
0960 0020	8" 200 mm	1	6	17,58	✓

ALICATES PUNTA / PINCE TÉLÉPHONE / LONG NOSE PLIERS / PINZE TELEFONISTI / ALICATE DE PONTAS



Ref					
0960 0182	6" 160 mm	1	6	11,91	✓
0960 0183	8" 200 mm	1	6	18,20	✓

ALICATES PELACABLES / PINCE A DÉNUDER CÂBLE / WIRESTRIPPER PLIERS / PINZE PELACAVI / ALICATE DE DESCARNAR



Ref					
0960 0181	6" 160 mm	1	6	17,50	✓

TENAZAS DE CANAL / PINCE MULTIPRISES ENTREPASSÉE / BOX JOINT PLIERS / PINZE REGOLABILI / ALICATE DE MULTIFIXAÇÃO



Ref					
0960 0221	10" 250 mm	1	6	21,11	✓





ALICATES CORTE DIAGONAL / PINCE COUPE DIAGONALE / DIAGONAL CUTTING PLIERS / PINZE TAGLIO DIAGONALE / ALICATE DE CORTE DIAGONAL



Ref					
0960 0160	6" 160 mm	1	6	12,12	✓

ALICATES PUNTA CURVA / PINCE TÉLÉPHONE COURBÉE / BENT NOSE PLIERS / PINZE TELEFONISTI A PUNTE RICURVE / ALICATE PONTAS CURVAS



Ref					
0960 0192	6" 160 mm	1	6	12,22	✓
0960 0193	8" 200 mm	1	6	17,11	✓

EXPOSITOR ALICATES ALTO RENDIMIENTO - 36 UNIDADES / PRESENTOIR DE PINCES - 36 UNITES / PLIERS EXHIBITOR - 36 PCS  
ESPOSITORE PINZE - 36 PEZZI / EXPOSITOR ALICATES DE ALTO RENDIMENTO - 36 UNIDADES







Ref			
0450 0960	0960 0017 x 3	1	645,74
	0960 0018 x 3		
	0960 0020 x 3		
	0960 0160 x 3		
	0960 0181 x 3		
	0960 0182 x 3		
	0960 0183 x 3		
	0960 0221 x 3		
	0960 0251 x 3		
	0960 0255 x 3		
	0960 0261 x 3		
	0960 0265 x 3		



ES Norma IEC DIN EN-60900, apto hasta 1000V AC. Acero cromo vanadio con tratamiento especial resistente al calor.  
 FR Norme IEC DIN EN-60900, jusqu'à 1000 V AC. Acier chromé vanadium avec traitement spécial pour résistance à la chaleur.  
 EN IEC Norm DIN EN-60900, up to 1000V AC. Chrome vanadium steel and special heat treatment.  
 IT Normativa IEC DIN EN-60900, idonee fino a 1000V AC. Acciaio cromo vanadio con trattamento speciale di resistenza al calore.  
 PT Norma IEC DIN EN-60900 apto até 1000V AC. Aço cromo vanadio com tratamento especial resistente ao calor.

ALICATES UNIVERSALES / PINCE UNIVERSELLE / UNIVERSAL PLIERS / PINZE UNIVERSALI / ALICATE UNIVERSAL



Ref					
<b>0960 0301</b>	6" 160 mm	1	6	<b>17,70</b>	✓
<b>0960 0302</b>	7" 180 mm	1	6	<b>19,98</b>	✓
<b>0960 0303</b>	8" 200 mm	1	6	<b>21,90</b>	✓

ALICATES PUNTA / PINCE TELEPHONE / LONG NOSE PLIERS / PINZE TELEFONISTI / ALICATE DE PONTAS



Ref					
<b>0960 0306</b>	6" 160 mm	1	6	<b>21,68</b>	✓
<b>0960 0307</b>	8" 200 mm	1	6	<b>25,32</b>	✓

ALICATES BOCA CURVA / PINCE TELEPHONE BEC C. ISLOEE / PLIERS / PINZA TELEF. RACCORDO CURVA / ALICATE PONTAS CURVAS



Ref					
<b>0960 0304</b>	6" 160 mm	1	6	<b>20,80</b>	✓
<b>0960 0305</b>	8" 200 mm	1	6	<b>24,20</b>	✓



ALICATES PUNTA REDONDA / PINCE RONDES / ROUND NOSE PLIERS / PINZE BECCHI TONDI / ALICATES PONTAS REDONDAS



Ref					
<b>0960 0309</b>	6" 160 mm	1	6	<b>18,18</b>	✓

ALICATES PUNTA PLANA / PINCE PUNTE PLATE / FLAT NOSE PLIERS / PINZE PUNTE PIATTE / ALICATES PONTAS PLANAS



Ref					
<b>0960 0313</b>	6" 160 mm	1	6	<b>18,18</b>	✓

ALICATES CORTA ALAMBRES REFORZADO / PINCE COUPANTES RENFORCÉES / HEAVY DUTY CUTTING  
PINZE TAGLIAFILFI RINFORZATO / ALICATES DE CORTE REFORÇADO

Ref					
<b>0960 0310</b>	6" 180 mm	1	6	<b>21,05</b>	✓
<b>0960 0311</b>	7" 200 mm	1	6	<b>23,76</b>	✓

ALICATES CORTA ALAMBRES DIAGONAL / PINCE COUPANTES RENFORCÉES / HEAVY DUTY DIAGONAL CUTTING PLIERS  
PINZE TAGLIAFILFI DIAGONALE / ALICATES DE CORTE DIAGONAL

Ref					
<b>0960 0308</b>	6" 160 mm	1	6	<b>18,20</b>	✓



TENAZAS DE CANAL / MULTIPRISE ENTREPASSÉE / BOX JOINT / A PAPPAGALLO / ALICATE DE MULTIFIXAÇÃO



Ref					
0960 0314	10"	1	6	32,97	✓

ALICATES PELACABLES / PINCE À DENUDER LES CÂBLES / WIRESTRIPPER PLIERS / PINZE PELACAVI / ALICATES DE DESCARNAR



Ref					
0960 0312	6" 160 mm	1	6	18,42	✓

EXPOSITOR ALICATES - 39 UNIDADES / PRESENTOIR DE PINCES - 39 UNITES / PLIERS EXHIBITOR - 39 PCS  
ESPOSITORE PINZE - 39 PEZZI / EXPOSITOR ALICATES - 39 UNIDADES



Ref			
0450 0961	0960 0301 x 3	1	801,25
	0960 0302 x 3		
	0960 0303 x 3		
	0960 0304 x 3		
	0960 0305 x 3		
	0960 0306 x 3		
	0960 0307 x 3		
	0960 0308 x 3		
	0960 0309 x 3		
	0960 0310 x 3		
	0960 0311 x 3		
	0960 0312 x 3		
	0960 0313 x 3		



ES Sensación de agarre fácil. Diseño ergonómico. Presión/Agarre superior en un 30% al tradicional. Mango bimetálico. Muelle perfectamente acoplado para evitar el riesgo de caída

FR Sensation de prise en main facile. Design ergonomique. Pression de serrage supérieure de 30% min a la pression habituelle. Manche a double materiaux. Ressort parfaitement adapte pour eviter tout risque de chute

EN Easy and comfortable grip. Ergonomic design. 30% better grip than usual. Bimaterial Handle. The spring is well fixed with no trouble of falling.

IT Facile presa. Disegno ergonomico. Pressione di serraggio superiore del 30% ad una tradizionale pinza. Impugnatura bi-materiale. Molle perfettamente adatte per evitare rischi di caduta

PT Boa aderência e confortável. Desenho ergonómico. Pressão 30% melhor aderência do que o habitual. Cabo bimetálico. A mola está bem fixa, sem problemas de queda.

ALICATES UNIVERSALES / PINCE UNIVERSELLE / UNIVERSAL PLIERS / PINZE UNIVERSALI / ALICATES UNIVERSAIS



Ref	↔	📦	📦	📦	📦
0960 0267	6" 160 mm	1	6	16,89	✓
0960 0268	7" 180 mm	1	6	17,91	✓
0960 0269	8" 200 mm	1	6	21,00	✓

ALICATES PUNTA / PINCE TÉLÉPHONE / LONG NOSE PLIERS / PINZE TELEFONISTI / ALICATES DE PONTAS



Ref	↔	📦	📦	📦	📦
0960 0271	6" 160 mm	1	6	16,64	✓
0960 0272	8" 200 mm	1	6	22,26	✓

ALICATES PUNTA BOCA CURVA / PINCES POINTE DOUBLE AVEC RESSORT / BENT NOSE PLIERS  
PINZE PUNTA DOPPIA C/MOLLA / ALICATES PONTAS CURVAS



Ref	↔	📦	📦	📦	📦
0960 0273	6" 160 mm	1	6	16,18	✓
0960 0274	8" 200 mm	1	6	22,15	✓

CORTA ALAMBRES CORTE DIAGONAL / PINCE COUPANTE AVEC RESSORT / DIAGONAL CUT  
PINZA DA TAGLIO C/MOLLA / ALICATE CORTA CABOS DIAGONAL



Ref	↔	📦	📦	📦	📦
0960 0270	6" 160 mm	1	6	16,38	✓





TENAZA MULTICIRCLIPS / TENAILLES MULTICIRCLIP / SEEGER CIRCLIP PLIERS / TENAGLIA MULTI CIRCLIPS / ALICATE MULTI-ANÉIS



Ref	∅				
0960 0259	10 - 50 mm	1	6	26,28	✓

EXTERIOR RECTO / EXTERIEUR DROIT / EXTERNAL STRAIGHT / ESTERNO PUNTE DRITTE / EXTERIOR RECTO



ES Gran superficie en los mangos: Máxima transmisión de fuerza.

FR Longueur importante des manches: Transmission maximale de l'effort.

EN Great extension handles: Strength transmission.

IT Grande distanza fra le maniglie: Massima trasmissione della forza.

PT Grande extensão das pegas: Máxima transmissão de força.

Ref		∅				
0960 0250	125 mm	10 - 25 mm	1	6	14,53	✓
0960 0251	175 mm	19 - 60 mm	1	6	17,87	✓
0960 0252	225 mm	40 - 100 mm	1	6	28,77	✓
0960 0253	300 mm	80 - 200 mm	1	6	42,15	✓

EXTERIOR CURVO / EXTERIOR COUDE / EXTERNAL BENT / ESTERNO PUNTE RICURVE / EXTERIOR CURVO



Ref		∅				
0960 0254	125 mm	10 - 25 mm	1	6	14,53	✓
0960 0255	175 mm	19 - 60 mm	1	6	17,87	✓
0960 0256	225 mm	40 - 100 mm	1	6	28,77	✓

INTERIOR RECTO / INTERIEUR DROIT / INTERNAL STRAIGHT / INTERNO PUNTE DRITTE / INTERIOR RECTO



Ref		∅				
0960 0260	125 mm	10 - 25 mm	1	6	14,53	✓
0960 0261	175 mm	19 - 60 mm	1	6	17,87	✓
0960 0262	225 mm	40 - 100 mm	1	6	28,77	✓
0960 0263	300 mm	80 - 200 mm	1	6	42,15	✓

INTERIOR CURVO / INTERIEUR COUDE / INTERNAL BENT / INTERNO PUNTE RICURVE / INTERIOR CURVO



Ref		∅				
0960 0264	125 mm	10 - 25 mm	1	6	14,53	✓
0960 0265	175 mm	19 - 60 mm	1	6	17,87	✓
0960 0266	225 mm	40 - 100 mm	1	6	28,77	✓



ALICATES MINI BOCA PLANA 5" / MINI PINCE PLATE 5" / 5" MINI PLAIN NOSE PLIERS / MINI PINZA A PUNTE PIATTE 5" / ALICATE MINI BOCA PLANA 5"



Ref	↔	📦	📦	📦	📦
0960 0322	5" 127 mm	1	6	7,59	✓

ALICATES MINI CORTE FRONTAL 4" / MINI PINCE COUPE FRONTALE 4" / 4" MINI FRONT CUTTING PLIERS  
MINI PINZA CON TAGLIO FRONTALE 4" / ALICATE MINI CORTE FRONTAL 4"

Ref	↔	📦	📦	📦	📦
0960 0323	4" 100 mm	1	6	7,59	✓

ALICATES MINI UNIVERSAL 5" / MINI PINCE UNIVERSELLE 5" / 5" MINI UNIVERSAL PLIERS / MINI PINZA UNIVERSALE 5" / ALICATE MINI UNIVERSAL 5"



Ref	↔	📦	📦	📦	📦
0960 0324	5" 127 mm	1	6	7,59	✓

ALICATES MINI TELEFONISTA 5" / MINI PINCE UNIVERSELLE 5" / 5" MINI TELEPHONIST PLIERS  
MINI PINZA TELEFONISTA 5" / ALICATE MINI TELEFONISTA 5"

Ref	↔	📦	📦	📦	📦
0960 0325	5" 127 mm	1	6	7,59	✓

ALICATES MINI BOCA AGUJA 6" / MINI PINCE AIGUILLE 6" / 6" MINI LONG NOSE PLIERS  
MINI PINZA A BECCO TONDO 6" / ALICATES MINI BICO AGULHA 6"

Ref	↔	📦	📦	📦	📦
0960 0320	6" 152 mm	1	6	7,59	✓

ALICATES MINI CORTE DIAGONAL 4" / MINI PINCE COUPE COUDE 4" / 4" MINI DIAGONAL CUTTING PLIERS  
MINI PINZA CON TAGLIO RICURVE 4" / ALICATE MINI CORTE DIAGONAL 4"

Ref	↔	📦	📦	📦	📦
0960 0321	4" 100 mm	1	6	7,59	✓



TENAZAS DE CANAL CON AUTO GRIP / MULTIPRISE ENTREPASSÉE / BOX JOINT / A PAPPAGALLO / TENAZES DE CANAL COM AUTO ADERÊNCIA

**AUTO GRIP**



Botón de ajuste rápido.  
Bouton de réglage rapide.  
Fast adjusting button.  
Pulsante di regolazione rapida.  
Botão de ajuste rápido.

Ref	↔	📦	📦	📦	📦
0951 1003	7"	1	6	27,14	✓
0951 1004	10"	1	6	30,68	✓
0951 1071	12"	1	6	37,68	✓

TENAZAS DE CANAL EFECTO MUELLE / PINCE EFFET RESSORT / BOX JOINT PINCER SPRING EFFECT  
PINZA A PAPPAGALLO / ALICATE BOMBA D'AGUA COM MOLA



Ref	↔	📦	📦	📦	📦
0951 1000	7"	1	6	36,08	✓
0951 1001	10"	1	6	45,18	✓
0951 1002	12"	1	6	55,02	✓

TENAZAS DE CANAL / MULTIPRISE ENTREPASSÉE / BOX JOINT / A PAPPAGALLO / TENAZES DE CANAL



Ref	↔	🔧	📦	📦	📦	📦
0951 1008	7"	✓	1	6	20,18	✓
0951 1009	10"	✓	1	6	24,86	✓
0951 1010	12"	✓	1	6	35,57	✓
0951 1070	16"	✓	1	6	74,65	✓

TENAZAS PICO DE LORO CON AUTO GRIP / MULTIPRISE A CRÉMAILLÈRE / GROOVE JOINT  
PINZE REGOLABILI / ALICATE BOMBA D'AGUA COM AUTO ADERÊNCIA

**AUTO GRIP**



Botón de ajuste rápido.  
Bouton de réglage rapide.  
Fast adjusting button.  
Pulsante di regolazione rapida.  
Botão de ajuste rápido.

Ref	↔	📦	📦	📦	📦
0951 1025	8"	1	6	36,76	✓
0951 1027	12"	1	6	61,15	✓

TENAZAS PICO DE LORO / MULTIPRISE A CRÉMAILLÈRE / GROOVE JOINT / TENAGLIE REGOLABILI / ALICATE BOMBA D'AGUA



Ref	↔	📦	📦	📦	📦
0951 1021	7" ½	1	6	32,83	✓
0951 1022	10"	1	6	40,53	✓
0951 1023	12"	1	6	58,23	✓
0951 1024	16"	1	6	91,56	✓



TENAZAS DE CARPINTERO / TENAILLE DE MENUISIER / CARPENTER PINCER / TENAGLIE DA CARPENTIERE / TORQUÊS CARPINTEIRO



Ref	↔	📦	📦	📦	📦
0951 1032	6"	1	6	16,12	✓
0951 1033	7"	1	6	17,58	✓
0951 1034	8"	1	6	18,62	✓
0951 1035	9"	1	6	21,42	✓

TENAZAS DE CARPINTERO / TENAILLE DE MENUISIER / CARPENTER PINCER  
TENAGLIE DA CARPENTIERE / TORQUÊS CARPINTEIRO

Ref	↔	📦	📦	📦	📦
0951 1028	6"	1	6	18,90	✓
0951 1029	7"	1	6	17,95	✓
0951 1030	8"	1	6	24,67	✓
0951 1031	9"	1	6	27,61	✓

TENAZAS RUSAS / TENAILLE RUSSE / TOWER PINCERS / PIEGATRICE / TORQUÊS ARMADOR



Ref	↔	📦	📦	📦	📦
0951 1039	9"	1	6	20,13	✓
0951 1040	10"	1	6	20,96	✓
0951 1041	11"	1	6	22,05	✓

TENAZAS PARA ALAMBRE / MULTIPRISE A CRÉMAILLÈRE / FENCING PLIER / PINZE REGOLABILI / ALICATE FAZENDEIRO



Ref	↔	📦	📦	📦	📦
0951 1046	10"	1	6	27,40	✓



BOCA CURVA / PINCE ÉTAU À COUPE / GRIP PLIERS WITH WIRE CUTTER / PINZA A MORSETTO CON TAGLIACAVI / MORDENTE CURVO



Ref	↔	🔪	🏋️	📏	📦	📦	📦
0951 1056	4"	CURVA	100 g	1	6	15,68	
0951 1057	5"		170 g	1	6	18,83	
0951 1058	7"		380 g	1	6	25,39	
0951 1059	10"		640 g	1	6	29,19	

BOCA RECTA / PINCE ÉTAU / STRAIGHT NOSE PLIERS / PINZA A MOLLA A GANASCE DRITTE / MORDENTE RETO



Ref	↔	🔪	🏋️	📏	📦	📦	📦
0951 1060	10"	RECTA	640 g	1	6	29,20	

BOCA LARGA / BECS LONGS / LONG NOSE PLIERS / A PUNTE LUNGHE / MORDENTE COMPRIDO



Ref	↔	🔪	🏋️	📏	📦	📦	📦
0951 1061	6,5"	LARGA	185 g	1	6	23,16	
0951 1062	8,5"	LARGA	360 g	1	6	36,66	

CON MORDAZAS PARA CHAPA / POUR TOLE / SHEET METAL GRIP PLIERS / CON GANASCE PER LAMIERA / COM MORDENTES PARA CHAPA



Ref	↔	🔪	🏋️	📏	📦	📦	📦
0951 1063	8"	P/ CHAPA	490 g	1	6	40,94	

CON MORDAZAS PARA SOLDADURA / POUR CORNIÈRE / WELDING GRIP PLIERS / CON GANASCE PER SALDATURA / COM MORDENTES PARA SOLDA



Ref	↔	🔪	🏋️	📏	📦	📦	📦
0951 1064	9"	P/SOLDAR	575 g	1	6	32,75	
0951 1065	11"	P/SOLDAR	815 g	1	6	36,38	





## TENAZAS / TENAILLE / PINCERS / TENAGLIE / TENAZES

CON MORDAZAS EN "C" BASCULANTES / PINCE-ETAU A MACHOIRES BASCULANTES / "C" SWIVEL - PAD CLAMPS  
CON GANASCE A "C" BASCULANTI / COM MORDENTES EM "C" BASCULANTES



Ref	↔	🔪	🏋️	📦	📦	📦
0951 1066	7"		300 g	1	6	<b>38,11</b>
0951 1067	11"	EN "C"	785 g	1	6	<b>52,12</b>
0951 1068	18"		1455 g	1	6	<b>77,90</b>

CON MORDAZAS EN "C" / PINCE-ETAU A MACHOIRES / "C" PAD CLAMPS / CON GANASCE A "C" / COM MORDENTES EM "C"



Ref	↔	🔪	🏋️	📦	📦	📦
0951 1069	11"	EN "C"	760 g	1	6	<b>41,30</b>

## TIJERAS / CISAILLES / SCISSORS / FORBICI / TESOURAS

TIJERAS ELECTRICISTA PROFESIONAL / CISEAUX D'ÉLECTRICIEN PROFESSIONNELS / PROFESSIONAL ELECTRICIAN SCISSORS  
FORBICI DA ELETTRICISTA PROFESSIONALE / TESOURA PROFISSIONAL DE ELECTRICISTA



Pelacables / Crimpar  
Pincés À Dénuder / Sertir  
Wire Strippers / Crimping  
Spelafili / Crimpare  
Desencapador / Crimpar

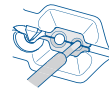

Ref	↔	🔪	📦	📦	📦	→
0950 8040	160 mm	Recta / Straight	1	6	<b>27,56</b>	

TIJERAS ELECTRICISTA PROFI MULTIFUNCIÓN / CISEUX D'ÉLECTRICIEN "PROFI" MULTIFONCTIONS / MULTI-PURPOSE ELECTRICIAN SCISSORS "PROFI"  
FORBICI DA ELETTRICISTA "PROFI" MULTIUSO / TESOURA DE ELECTRICISTA "PROFI" MULTIFUNCIONAL



Ref	↔	🔪	📦	📦	📦	→
0950 8045	150 mm	Recta / Straight	1	6	<b>17,06</b>	

TIJERAS PARA CHAPA / CISAILLES A TOLE / TIN SNIPS / LAMA PER LAMIERA / TESOURA CORTE CHAPA



Ref	↔	🔪	📦	📦	📦
0951 1052	250 mm - 10"	1.2	1	6	<b>19,86</b>



TIJERAS ARTICULADAS / CISAILLE ARTICULÉE / AVIATION TIN SNIPS / FORBICI ARTICOLATE / TESOURAS ARTICULADAS



Corte central / Coupe centrale / Center cut / Taglio centrale / Corte Central

Ref	↔	✂	📦	📦	📦
<b>0951 1048</b>	250 mm - 10"	1.2	1	6	<b>15,49</b>

TIJERAS ARTICULADAS / CISAILLE ARTICULÉE / AVIATION TIN SNIPS / FORBICI ARTICOLATE / TESOURAS ARTICULADAS



Corte derecha / Coupe droite / Right Cut / Taglio a destra / Corte p/ direita

Ref	↔	✂	📦	📦	📦
<b>0951 1047</b>	250 mm - 10"	1.2	1	6	<b>16,22</b>

TIJERAS ARTICULADAS / CISAILLE ARTICULÉE / AVIATION TIN SNIPS / FORBICI ARTICOLATE / TESOURAS ARTICULADAS



Corte izquierda / Coupe gauche / Left cut / Taglio a sinistra / Corte p/ esquerda

Ref	↔	✂	📦	📦	📦
<b>0951 1049</b>	250 mm - 10"	1.2	1	6	<b>16,22</b>

TENAZAS CORTABRIDAS / TENAILLES POUR BRIDE / CABLE TIES PLIERS / PINZA TAGLIACAVI / ALICATE DE CORTE



Ref	↔	📦	📦	📦
<b>0950 8000</b>	150 mm	1	6	<b>17,71</b>

CIZALLA ROEDORA DE CHAPA / GRIGNOTEUSE / RATCHET SNIPS / CESCOIE PER LAMIERE / TESOURA ROEDORA DE CHAPA



Ref	↔	✂	📦	📦	📦	
<b>0951 1050</b>	250 mm - 10"	1.2	465 mm	1	6	<b>89,44</b>

CUCHILLA RECAMBIO / LAME DE RECHANGE / SPARE BLADE  
SOSTITUZIONE LAMA / LÂMINA DE REPOSIÇÃO

Ref	📦	📦	📦
<b>0951 1051</b>	1	6	<b>9,44</b>



CORTAVARILLAS MINI / COUPE BOULONS / BOLT CUTTERS / TAGLIA BARRE / CORTA-CABOS MINI



Ref	↔	>0< cap 140 Kg/mm <sup>2</sup>	📦	📦	📦
0951 1133	205 mm	3	1	6	33,25

CORTAVARILLAS / COUPE BOULONS / BOLT CUTTERS / TAGLIABARRE / ALICATE DE CORTAR FERRO C/REGULADOR CENTRAL



Ref	↔	50 Kg/mm <sup>2</sup>	140 Kg/mm <sup>2</sup>	📦	📦	📦
0951 1107	14"	7	5	1.100 g	1	39,90
0951 1108	18"	8	6	1.500 g	1	49,50
0951 1109	24"	10	8	2.400 g	1	69,90
0951 1110	30"	13	10	3.700 g	1	95,35
0951 1111	36"	16	12	5.800 g	1	107,40

CORTAVARILLAS DE MESA / COUPE-BOULONS HORIZONTAL / BOLT CUTTER BENCH TYPE / TAGLIERINA DA BANCO / CORTA-CABOS DE MESA



Ref	↔	50 Kg/mm <sup>2</sup>	140 Kg/mm <sup>2</sup>	📦	📦
0951 1114	24"	10	8	1	308,22

CORTAVARILLAS MANGOS FORJADOS / MANCHES FORGÉS / FORGED HANDLES / MANICI FORGIATI / CORTA-CABOS COM PEGAS FORJADAS



Ref	↔	📦	📦
0951 4083	18"	1	160,24
0951 4084	24"	1	183,28
0951 4085	30"	1	239,29
0951 4086	36"	1	320,49

CORTACABLES DE ACERO REFORZADO / COUPE CÂBLES EN ACIER RENFORCÉ / HD WIRE ROPE CUTTER  
TAGLIACAVO IN ACCIAIO RINFORZATO / CORTA-CABOS DE AÇO REFORÇADO



Cables de acero / Inox  
Steel / Stainless steel cables

Ref	↔	50 Kg/mm <sup>2</sup>	140 Kg/mm <sup>2</sup>	📦	📦
0951 1115	24"	14	10	1	312,75
0951 1116	36"	18	12	1	424,28
0951 1117	42"	22	13	1	501,48



CORTACABLES DE MESA / COUPE-BOULONS HORIZONTAL / WIRE ROPE CUTTER BENCH TYPE / TAGLIACAVO DA BANCO / CORTA-CABOS DE MESA



Acero / Inox  
Steel / Stainless Steel

Ref	↔	50 Kg/mm2	140 Kg/mm2		
0951 1118	24"	10	8	1	559,80

TENAZAS CORTACABLES / COUPE CABLES / CABLE CUTTER / TENAGLIA TAGLIACAVI / TESOURA CORTA CABOS



ES Para cobre y aluminio.  
FR Pour cuivre et aluminium.  
EN For copper & aluminium.  
IT Per rame e alluminio.  
PT Para cobre e alumínio.

Ref	↔	>0< cap	TPI			
0951 4231	220 mm	12	390 g	1	6	29,41

TENAZAS CORTACABLES / COUPE CABLES / CABLE CUTTER / TENAGLIA TAGLIACAVI / TESOURA CORTA CABOS



ES Para cobre y aluminio.  
FR Pour cuivre et aluminium.  
EN For copper & aluminium.  
IT Per rame e alluminio.  
PT Para cobre e alumínio.

Ref	↔	>0< cap	TPI		
0951 4232	600 mm	10	1700 g	1	248,91

ARCO SIERRA MADERA CONFORT / SCIE A BOIS CONFORT / HACK SAW, WOOD COMFORT  
SEGHETTO AD ARCO CONFORT, LEGNO / ARCO DE SERRA MADEIRA CONFORT



Ref	↔				
0951 4411	300 mm - 12"	575 g	1	5	19,74



ARCO SIERRA MADERA PUNTA CONFORT / SCIE A BOIS CONFORT / BOW SAW WOOD COMFORT  
SEGHETTO AD ARCO CONFORT, LEGNO / ARCO DE SERRA MADEIRA CONFORT



Ref	↔	kg	📦	📦	📦
0951 4412	533 mm - 21"	670 g	1	5	19,74

ARCO SIERRA MADERA CONFORT / SCIE A BOIS CONFORT / HACK SAW, WOOD COMFORT  
SEGHETTO AD ARCO CONFORT, LEGNO / ARCO DE SERRA MADEIRA CONFORT



Ref	↔	kg	📦	📦	📦
0951 4413	533 mm - 21"	670 g	1	5	19,74

ARCO SIERRA MADERA CONFORT / SCIE A BOIS CONFORT / HACK SAW, WOOD COMFORT  
SEGHETTO AD ARCO CONFORT, LEGNO / ARCO DE SERRA MADEIRA CONFORT



Ref	↔	kg	📦	📦	📦
0951 4414	610 mm - 24"	740 g	1	5	20,80
0951 4415	762 mm - 30"	850 g	1	5	21,74

ARCO SIERRA MADERA ESTÁNDAR / SCIE A BOIS STANDARD / HACK SAW, WOOD STANDARD  
SEGHETTO AD ARCO STANDARD, LEGNO / ARCO DE SERRA MADEIRA STANDARD



Ref	↔	kg	📦	📦	📦
0951 4432	533 mm - 21"	460 g	1	12	6,77
0951 4433	610 mm - 24"	610 g	1	12	7,86
0951 4434	762 mm - 30"	710 g	1	12	8,63





ARCO SIERRA MADERA PUNTA PROTECT / SCIE A BOIS POINTE PROTECT / WOODEN HACKSAW FRAME PROTECT TIP  
SEGHETTO AD ARCO A PUNTA PROTECT, LEGNO / ARCO DE SERRA MADEIRA PONTA PROTECT



Ref	↔	kg	📦	📦	📦
0951 4417	300 mm - 12"	670 g	1	12	6,76

ARCO SIERRA MADERA PROTECT / SCIE A BOIS PROTECT / HACK SAW, WOOD PROTECT  
SEGHETTO AD ARCO CON PROTEZIONE, LEGNO / ARCO DE SERRA MADEIRA PROTECT



Ref	↔	kg	📦	📦	📦
0951 4422	533 mm - 21"	460 g	1	12	8,16
0951 4423	610 mm - 24"	610 g	1	12	9,26
0951 4424	762 mm - 30"	710 g	1	12	9,96

HOJAS DE SIERRA MADERA SECA / FEUILLES DE SCIE BOIS SEC / SAW BLADES, DRY WOOD  
LAME SEGHETTO, LEGNO SECCO / LÁMINAS DE SERRA MADEIRA SECA



Ref	↔	📦	📦
0951 4441	300 mm - 12"	1	1,61
0951 4443	533 mm - 21"	1	2,07
0951 4444	610 mm - 24"	1	2,32
0951 4445	762 mm - 30"	1	2,58

HOJAS DE SIERRA MADERA VERDE / FEUILLES DE SCIE BOIS VERT / SAW BLADES, GREEN WOOD  
LAME SEGHETTO, LEGNO VERDE / LÁMINAS DE SERRA MADEIRA VERDE



Ref	↔	📦	📦
0951 4451	300 mm - 12"	1	1,61
0951 4453	533 mm - 21"	1	2,07
0951 4454	610 mm - 24"	1	2,32
0951 4455	762 mm - 30"	1	2,58

SERRUCHO CARPINTERO / SCIE DE CHARPENTIER / HAND SAW, CARPENTER / SEGHETTO FALEGNAME / SERROTE CARPINTEIRO



Ref	↔	📦	📦	📦
0951 4461	400 mm - 16"	1	12	11,49
0951 4462	450 mm - 18"	1	12	12,12
0951 4463	500 mm - 20"	1	12	12,74
0951 4464	550 mm - 22"	1	12	13,68



ARCO SIERRA METAL ESTÁNDAR / SCIE METALLIQUE STANDARD / HACK SAW, METAL STANDARD  
 SEGHEtto AD ARCO STANDARD, METALLO / ARCO DE SERRA METAL STANDARD

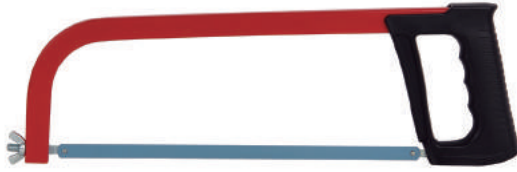

ACERO / STEEL / ACIER

Ref	↔	⚖️	📦	📦	📦
0951 4289	300 mm	380 g	1	12	9,96

ARCOS DE SIERRA PROFESIONAL / SCIE PROFESSIONNEL / SAW ARC / SEGHEtto PROFESSIONALE / SERROTE CORTAR FERRO



ACERO / STEEL / ACIER

Ref	↔	⚖️	📦	📦	📦
0951 4280	300 mm	480 g	1	6	14,62

ARCOS DE SIERRA / MONTURE A SCIE À MÉTAUX / HACK SAW / SEGA AD ARCO / ARCO DE SERRA



ACERO / STEEL / ACIER

Ref	↔	⚖️	📦	📦	📦
0951 4228	0° - 90°	450 g	1	6	15,82

ARCO DE SIERRA TENSIÓN AJUSTABLE METAL / ARC DE SCIE TENSION REGLABLE (METAL) / HACKSAW FRAME ADJUSTABLE TENSION METAL  
 SEGA AD ARCO TENSIOne REGOLABILE (METAL) / SERROTE TENSÃO AJUSTÁVEL



Ref	↔	⚖️	📦	📦	📦
0951 4470	300 mm	650 g	1	6	29,64

HOJA DE SIERRA BI-METAL / LAMES DE SCIE BI-METAL / BI-METAL SAW BLADE / LAMA PER SEGA BI-METALLO / FOLHA DE SERRA BI-METAL



Ref	▨	📦	TPI	📦	📦	📦
0951 4230	Bi-Metal	300x13x0,65 mm	24	1	100	2,09



CÚTTER ZAMAK / COUTEAU DE SECURITE / TRIMMING KNIFE / TAGLIERINA CON LAMA / XIS-ATO ZAMAK

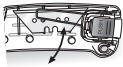

ES Apertura del cuchillo sin necesidad de herramientas.  
FR Ouverture du couteau sans besoin d'outils.  
EN Easy-opening system - for changing the blade, no need of tool.  
IT Cambio lama senza necessità di ulteriore attrezzatura.  
PT Abertura do xis-ato sem necessidade de ferramentas.

Ref				
0951 4350	1	10	8,91	✓

CÚTTER RETRACTIL ZAMAK AUTOMÁTICO / COUTEAU AUTOMATIQUE / AUTOMATIC UTILITY KNIFE  
TAGLIERINA AUTOMATICA CON LAMA RETRATTILE / XIS-ATO RETRACTIL ZAMAK AUTOMATICO

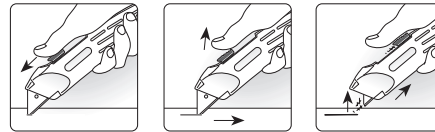
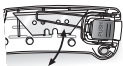

Ref				
0951 4351	1	10	9,60	✓

PACK 5 CUCHILLAS TRAPEZOIDALES 60 mm / PACK 5 LAMES TRAPÉZOÏDALES 60 mm / 5 SPARE BLADES PACK 60 mm  
CONFEZIONE DA 5 LAME TRAPEZOIDALI DA 60 mm / PACOTE DE 5 LÂMINAS 60 mm

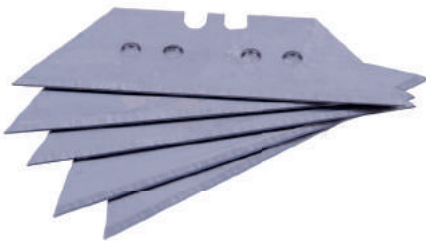

Válido para: / Valide pour: / Valid for: / Valido per: / Válido para: 0951 4350 - 0951 4351

Ref		PACK				Precio x pack Price x pack
0951 4352	60 x 19 x 0,65 mm	5 uds.	1 pack	20 packs	1,40	

PACK 5 CUCHILLAS TIPO GANCHO CÚTTER ZAMAK / PACK 5 LAMES TYPE CROCHET CUTTER ZAMAK / PACK OF 5 HOOK BLADES ZAMAK BOX CUTTER  
CONFEZIONE 5 LAME PER TAGLIERINO ZAMAK / PACK 5 LÂMINAS TIPO GANCHO XIS-ATO ZAMAK



Válido para: / Valide pour: / Valid for: / Valido per: / Válido para: 0951 4350 - 0951 4351



Ref		PACK				Precio x pack Price x pack
0951 4353	60 x 19 x 0,65 mm	5 uds.	1 pack	20 packs	2,70	

CÚTTER ESPECIAL FLEJES CUCHILLA OCULTA / CUTTER SÉCIAL FEUILLARDS LAME OCULTE / SPECIAL BOX CUTTER, HIDDEN BLADE  
TAGLIERINA SPECIALE A LAMA NASCOSTA / CORTADOR ESPECIAL TIRAS LÂMINA OCULTA



Ref			
1054 0012	4,21	1	✓



CÚTTER HOJA PARTIBLE, CUERPO ZAMAK 18 mm / CUTTER / KNIFE / TAGLIERINA / XISATO

18 mm



Ref				
1054 0003	6-76 mm	1	18,17	✓

CÚTTER CON CUCHILLAS INTERCAMBIABLES / CUTTER AVEC LAMES DE RECHANGES / KNIFE WITH EXCHANGEABLE BLADES  
TAGLIERINE CON LAME INTERCAMBIABILI / XIS-ATO COM LÂMINAS TROCÁVEIS

18 mm



ES Contiene 3 cuchillas. Sistema automático cambio de cuchillas.  
FR Contient 3 lames. Systeme automatique de changement de lames.  
EN 3 blades included. Automatic blade-change system.  
IT Contiene 3 lame. Dispositivo di cambio lame automatico.  
PT Inclui 3 lâminas. Sistema automático de troca de lâminas.

Ref				
1054 0001	6-76 mm	1	12	4,30 ✓

CÚTTER ESTÁNDAR EN ABS / CUTTER ABS / ABS UTILITY KNIFE / TAGLIERINO STANDARD IN ABS / CORTADOR STANDARD ABS

18 mm



Ref				
1054 0011	18x100 mm	1	12	1,05 ✓

RECAMBIOS CUCHILLAS / PIECES DE RECHANGE / EXTRA BLADES / LAME DI RICAMBIO / SUBSTITUIÇÃO DE LÂMINAS

18 mm



Válido para: / Valide pour: / Valid for: / Valido per: / Válido para:  
1054 0001 - 1054 0003 - 1054 0011

Precio x pack  
Price x pack

Ref	PACK			
1054 1001	10 uds.	1 pack	1,70	✓

CÚTTER METÁLICO INOX / CUTTER INOX METALLIQUE / STAINLESS STEEL KNIFE / TAGLIERINA METALLICA INOX / XISATO METÁLICO EM INOX

9 mm  
INOX



Ref				
1054 0002	1	24	1,42	✓



CÚTTER ABS EN BLÍSTER / CUTTER ABS BLISTER / ABS UTILITY KNIFE IN BLISTER / BLISTER TAGLIERINO IN ABS / CORTADOR ABS EM BLISTER

3 UDS



9 mm

Precio x pack  
Price x pack

Ref	↔	PACK	📦	📦	📦	📦
1054 0013	9 mm	3 uds.	1	10	1,75	✓

RECAMBIOS CUCHILLAS / PIECES DE RECHANGE / EXTRA BLADES / LAME DI RICAMBIO / SUBSTITUIÇÃO DE LÂMINAS

Válido para: / Valide pour: / Valid for: / Valido per: / Válido para: 1054 0002 - 1054 0013

9 mm



Precio x pack  
Price x pack

Ref	PACK	📦	📦
1054 1002	10 uds.	1 pack	0,99

NAVAJAS / CANIF / PENKNIFE / COLTELLI / NAVALHAS



Ref	🔪	🔪	🏷️	📦	📦	📦
0951 6052	68 mm	85 mm	40 g	1	12	24,36
0951 6053	75 mm	100 mm	50 g	1	12	30,26

NAVAJAS / CANIF / PENKNIFE / COLTELLI / NAVALHAS



Ref	🔪	🔪	🏷️	📦	📦	📦
0950 8030	84 mm	110 mm	70 g	1	12	19,39

NAVAJAS / CANIF / PENKNIFE / COLTELLI / NAVALHAS



Ref	🔪	🔪	🏷️	📦	📦	📦
0950 8031	73 mm	120 mm	70 g	1	12	38,40





GRANETES / DISPOSITIF DE TRACER / CENTRE PUNCH / BULINI / PUNÇÕES



Ref	↔	∅	📦	📦	📦
<b>0962 5200</b>	90 mm - 3" 1/2	2 mm - 5/64"	1	10	<b>2,81</b>
<b>0962 5201</b>	108 mm - 4" 1/4	3 mm - 1/8"	1	10	<b>3,17</b>
<b>0962 5202</b>	125 mm - 5"	4 mm - 5/32"	1	10	<b>3,54</b>
<b>0962 5203</b>	150 mm - 6"	6 mm - 1/4"	1	10	<b>5,51</b>
<b>0962 5204</b>	160 mm - 6" 1/4	10 mm - 3/8"	1	10	<b>8,42</b>

ES Juego granetes. 5 pcs.

FR Dispositifs de tracer. 5 pcs.

EN Centre punches kit. 5 pcs.

IT Kit bulini. 5 pcs.

PT Jogo de punções. 5 pcs.

Ref	📦	📦	📦
<b>0962 5205</b>	2 - 3 - 4 - 6 - 10 mm	1	<b>23,14</b>

GRANETE AUTOMÁTICO / POINÇONS AUTOMATIQUES / AUTOMATIC CENTRE PUNCHES / BULINO AUTOMATICO / PUNÇÃO AUTOMÁTICO



Ref	↔	∅	📦	📦
<b>0962 5000</b>	120 mm	4 mm 5/32"	1	<b>11,28</b>

BOTADORES CILÍNDRICOS / CHASSE CLOU CYLINDRIQUE / CYLINDRICAL PIN PUNCHES / BULINI CILINDRICI / PERFURADORES CILÍNDRICOS



Ref	↔	∅	📦	📦	📦
<b>0962 5600</b>	100 mm - 4"	1,5 mm - 1/16"	1	10	<b>2,29</b>
<b>0962 5601</b>	112 mm - 4" 1/2	2,5 mm - 3/32"	1	10	<b>3,17</b>
<b>0962 5602</b>	119 mm - 4" 3/4	3 mm - 1/8"	1	10	<b>2,76</b>
<b>0962 5603</b>	125 mm - 5"	4 mm - 5/32"	1	10	<b>2,81</b>
<b>0962 5604</b>	132 mm - 5" 1/4	5 mm - 3/16"	1	10	<b>3,33</b>
<b>0962 5605</b>	138 mm - 5" 1/2	5,5 mm - 7/32"	1	10	<b>3,48</b>
<b>0962 5606</b>	145 mm - 5" 3/4	6 mm - 1/4"	1	10	<b>4,11</b>
<b>0962 5607</b>	150 mm - 6"	8 mm - 5/16"	1	10	<b>5,36</b>
<b>0962 5608</b>	163 mm - 6" 1/2	10 mm - 3/8"	1	10	<b>6,66</b>

ES Juego botadores cilíndricos. 7 pcs.

FR Kit chasse clou cylindrique. 7 pcs.

EN Kit of pin punches. 7 pcs.

IT Kit punzoni cilindrici. 7 pcs.

PT Jogo de perfuradores cilíndricos. 7 pcs.

Ref	📦	📦	📦
<b>0962 5611</b>	1,5 - 2,5 - 3 - 4 - 5 - 5,5 - 6 mm	1	<b>23,19</b>



PUNZONES DE NÚMEROS - LETRAS / SET IMPRESION CHIFFRES - LETTRES / STEEL STAMPS NUMBERS - LETTERS  
PUNZONI LETTERE - NUMERI / PUNÇÕES DE NÚMEROS - LETRAS



Ref	∅			
<b>0962 5902</b>	3 mm	9 pcs - (0-9)	1	<b>8,94</b>
<b>0962 5905</b>	6 mm	9 pcs - (0-9)	1	<b>15,18</b>

Ref	∅			
<b>0962 6102</b>	3 mm	27 pcs - (A-Z)	1	<b>24,39</b>
<b>0962 6105</b>	6 mm	27 pcs - (A-Z)	1	<b>42,54</b>

SACABOCADOS CILÍNDRICOS / EXTRACTEUR MATÉRIAUX LÉGERS / CYLINDRICAL HOLLOW PUNCHES  
PUNZONI CILINDRICI / PERFURADOR CILÍNDRICO OCO



Ref				
<b>0962 6302</b>	2 mm - 3/32"	1	10	<b>2,50</b>
<b>0962 6303</b>	3 mm - 1/8"	1	10	<b>2,50</b>
<b>0962 6304</b>	4 mm - 5/32"	1	10	<b>2,70</b>
<b>0962 6305</b>	5 mm - 3/16"	1	10	<b>2,91</b>
<b>0962 6306</b>	6 mm - 1/4"	1	10	<b>3,22</b>
<b>0962 6307</b>	7 mm - 9/32"	1	10	<b>3,54</b>
<b>0962 6308</b>	8 mm - 5/16"	1	10	<b>3,74</b>
<b>0962 6309</b>	9 mm - 23/64"	1	10	<b>4,11</b>
<b>0962 6310</b>	10 mm - 3/8"	1	10	<b>4,99</b>
<b>0962 6311</b>	11 mm - 7/16"	1	10	<b>5,72</b>
<b>0962 6312</b>	12 mm - 1/2"	1	10	<b>6,19</b>
<b>0962 6313</b>	13 mm - 17/32"	1	10	<b>7,49</b>
<b>0962 6314</b>	14 mm - 9/16"	1	10	<b>7,64</b>
<b>0962 6315</b>	15 mm - 19/32"	1	10	<b>8,94</b>
<b>0962 6316</b>	16 mm - 5/8"	1	10	<b>9,78</b>
<b>0962 6317</b>	17 mm - 11/16"	1	10	<b>9,98</b>
<b>0962 6318</b>	18 mm - 23/32"	1	10	<b>10,92</b>
<b>0962 6319</b>	19 mm - 3/4"	1	10	<b>11,02</b>
<b>0962 6320</b>	20 mm - 13/16"	1	10	<b>11,23</b>
<b>0962 6321</b>	21 mm - 27/32"	1	10	<b>11,96</b>
<b>0962 6322</b>	22 mm - 7/8"	1	10	<b>12,27</b>
<b>0962 6323</b>	23 mm - 29/32"	1	10	<b>13,73</b>
<b>0962 6324</b>	24 mm - 15/16"	1	10	<b>14,46</b>
<b>0962 6325</b>	25 mm - 1"	1	10	<b>15,50</b>

ES Juego sacabocados cilíndricos. 6 pcs.

FR Kit extration cylindrique. 6 pcs.

EN Hollow punches kit. 6 pcs.

IT Kit punzoni cilindrici. 6 pcs.

PT Jogo de perfuradores cilíndricos. 6 pcs.

Ref			
<b>0962 6391</b>	5 - 6 - 8 - 10 - 11 - 12 mm 3/10" - 1/4" - 5/16" - 3/8" - 7/16" - 12"	1	<b>27,56</b>



SACABOCADOS TIPO ESTRELLA / PINCE EMPORTE - PIECE / REVOLVING PUNCH PLIERS  
PINZA FUSTELLATRICE / FURADOR PERFURADOR TIPO ESTRELLA



ES Cabezal giratorio con 6 pinzas sacabocados.  
FR Tête pivotante avec 6 pinces à punch mesures.  
EN Spring loaded revolving head incorporates 6 punches.  
IT Testa girevole a 6 punzoni.  
PT Cabeça giratória com 6 pinos furadores.

Ref			
<b>0962 6392</b>	2 mm - 5/64" // 2,5 mm - 3/32" 3 mm - 1/8" // 3,5 mm - 9/64" 4 mm - 5/32" // 4,5 mm - 3/16"	1	<b>16,38</b>

KIT COMPLETO OJETES Y OLLAOS / KIT COMPLET ŒILLETS / COMPLETE GROMMET KIT  
KIT COMPLETO OCCHIELLI E ANELLI DI TENUTA / KIT COMPLETO DE ILHÓS E ANILHAS



Ref			
<b>0951 0501</b>	10 y 12 mm	1	<b>20,70</b>

KIT DE 12 SETS DE OJETES / KIT DE 12 ŒILLETS COMPLETS / 12-SET KIT COMPOSED OF GROMMETS AND WASHERS  
KIT DI 12 OCCHIELLI / KIT DE 12 JOGOS DE ILHÓS

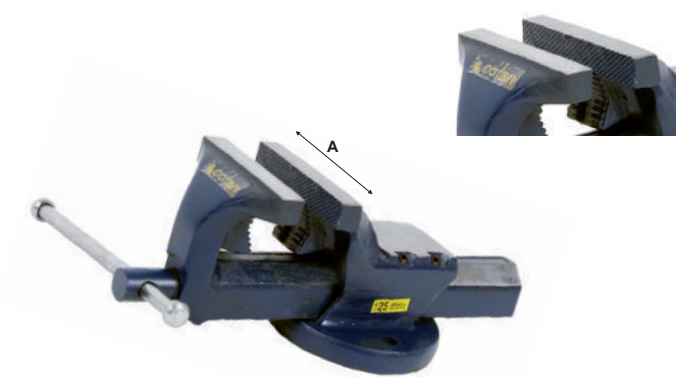

Ref			
<b>0951 0502</b>	10 mm	1	<b>5,15</b>
<b>0951 0503</b>	12 mm	1	<b>8,11</b>

**TORNILLO DE BANCO PARALELO / ETAU A MORS PARALLELES / PARALLEL BENCH VICE  
MORSA PARALLELA DA BANCO / TORNO DE BANCADA PARALELO**

ES Mordazas para tubo. Acero forjado.  
FR Avec machoires pour tube. Acier forge.  
EN With pipe jaws. Forged steel.  
IT Con ganasce per tubo. In acciaio forgiato.  
PT Torno de bancada para tubos . Aço forjado.

Ref	∅	A	kg		
<b>0951 8000</b>	100 mm	4"	6,50 kg	1	<b>98,79</b>
<b>0951 8001</b>	125 mm	5"	17,50 kg	1	<b>156,20</b>
<b>0951 8002</b>	150 mm	6"	20,50 kg	1	<b>260,70</b>

**TORNILLO DE BANCO PARALELO GIRATORIO / ETAU A MORS PARALLELES / ROTATORY PARALLEL BENCH VICE  
MORSA PARALLELA DA BANCO / TORNO DE BANCADA PARALELO GIRATÓRIO**

ES Mordazas para tubo. Acero forjado.  
FR Avec machoires pour tube. Acier forge.  
EN With pipe jaws. Forged steel.  
IT Con ganasce per tubo. In acciaio forgiato.  
PT Torno de bancada para tubos . Aço forjado.

Ref	∅	A	kg		
<b>0951 8003</b>	100 mm	4"	7,50 kg	1	<b>108,88</b>
<b>0951 8004</b>	125 mm	5"	18,50 kg	1	<b>163,73</b>
<b>0951 8005</b>	150 mm	6"	21,50 kg	1	<b>300,60</b>

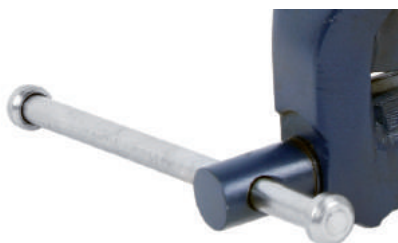
**BARRA DEL TORNILLO / BARRE DE LA VIS / BENCH VICE BAR / BARRA DELLA MORSA / BARRA DO PARAFUSO**

Ref			
<b>0951 8000.01</b>	4"	1	<b>12,00</b>
<b>0951 8001.01</b>	5"	1	<b>12,00</b>
<b>0951 8002.01</b>	6"	1	<b>12,00</b>

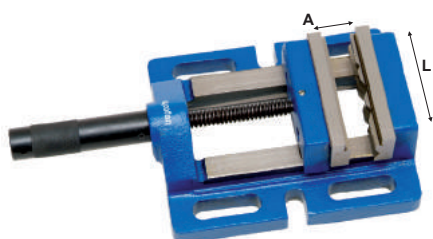
**MORZAS PARA TALADRO DE BANCO / SUPPORT POUR PERCEUSE / DRILL CLAMPS / MORSE PER TRAPANO DA BANCO / GRAMPOS PARA PERFURAÇÃO**

Ref	L	A		
<b>0951 8012</b>	100 mm	92 mm	1	<b>99,40</b>
<b>0951 8013</b>	120 mm	110 mm	1	<b>178,65</b>



EXTRACTOR 2 Y 3 GARRAS ARTICULADAS 2 POSICIONES / EXTRACTEUR 2 ET 3 GRIFFES ARTICULÉES, 2 POSITIONS / 2 AND 3 JAW GEAR PULLER, 2 POSITIONS  
 ESTRATTORE 2 E 3 BRACCI ARTICOLATI, 2 POSIZIONI / EXTRATOR COM 2 E 3 GARRAS ARTICULADAS

**GARRAS REVERSIBLES****3 in 1**

Ref	H	Tn		
0951 3263	50 - 80 mm	2	1	<b>88,92</b>
0951 3264	100 - 150 mm	5	1	<b>140,40</b>
0951 3265	125 - 218 mm	7	1	<b>187,20</b>

EXTRACTOR 2 GARRAS ARTICULADAS 2 POSICIONES / EXTRACTEUR 2 GRIFFES ARTICULÉES, 2 POSITIONS / 2 JAW GEAR PULLER, 2 POSITIONS  
 ESTRATTORE 2 BRACCI ARTICOLATI, 2 POSIZIONI / EXTRATOR COM 2 GARRAS ARTICULADAS

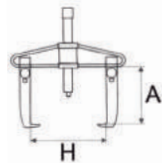
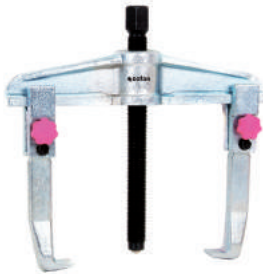
**Cr/V**

Ref	H	A		
0951 6040	25-80 mm	100 mm	1	<b>123,40</b>
0951 6041	25-130 mm	100 mm	1	<b>130,84</b>
0951 6042	50-160 mm	150 mm	1	<b>211,21</b>
0951 6043	60-200 mm	150 mm	1	<b>233,01</b>
0951 6044	80-250 mm	200 mm	1	<b>381,46</b>

EXTRACTOR 3 GARRAS ARTICULADAS REVERSIBLES / EXTRACTEUR 3 GRIFFES ARTICULÉES REVERSIBLES / 3 JAW REVERSIBLE GEAR PULLER  
 ESTRATTORE 3 BRACCI ARTICOLATI REVERSIBILI / EXTRATOR COM 3 GARRAS ARTICULADAS REVERSÍVEIS

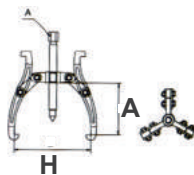
**Cr/V**

Ref	Ø	H	A		
0951 1147	3"	15-80 mm	70 mm	1	<b>25,40</b>
0951 1148	6"	25-160 mm	140 mm	1	<b>30,25</b>
0951 1149	8"	30-210 mm	180 mm	1	<b>42,30</b>
0951 1150	12"	50-317 mm	280 mm	1	<b>378,99</b>

DESMONTABLE NEUMÁTICOS / DEMONTE PNEUS / TYRE LEVER / CHIAVE SMONTAGGIO PNEUMATICI / DESMONTA PNEUS

**Cr/V**

Ref				
0951 7138	200 x 19	1	2	<b>14,64</b>
0951 7139	300 x 25	1	2	<b>18,47</b>
0951 7140	400 x 25	1	2	<b>22,28</b>
0951 7141	600 x 19	1	2	<b>24,20</b>





MARTILLO DE BOLA / MARTEAU BOULE / BALL PEIN HAMMER / MARTELLO SFERICO / MARTELO DE BOLA



Ref		MODEL			
0951 5009	230 g	A	1	6	<b>6,20</b>
0951 5010	330 g	B	1	6	<b>8,32</b>
0951 5011	450 g	C	1	6	<b>9,56</b>
0951 5012	700 g	E	1	6	<b>12,13</b>
0951 5013	900 g	F	1	6	<b>13,07</b>
0951 5106	1200 g	G	1	6	<b>15,39</b>

MACETA CUADRADA / MASSETTE / STONING HAMMER / MAZZETA QUADRATA / MARRETA QUADRADO



Ref				
0951 5018	1.000 g	1	6	<b>13,71</b>
0951 5020	1.500 g	1	6	<b>17,75</b>

MACETA MODELO ESPAÑOL / MASSETTE / SPANISH TYPE STONING HAMMER / MAZZETTA MODELLO SPAGNOLO / MARRETA MOD. ESPANHOL



Ref				
0951 5021	700 g	1	6	<b>13,46</b>
0951 5022	1.000 g	1	6	<b>15,13</b>
0951 5023	1.400 g	1	6	<b>17,87</b>

MARTILLO DE EBANISTA / MASSETTE / STONING HAMMER / MAZZETTA QUADRATA / MARTELO DE PENNA



Ref		MODEL			
0951 5025	140 g	A-18 mm	1	6	<b>6,34</b>
0951 5026	180 g	B-20 mm	1	6	<b>7,59</b>
0951 5027	230 g	C-22 mm	1	6	<b>7,63</b>
0951 5028	320 g	D-25 mm	1	6	<b>8,31</b>

MOD. AMERICANO

MARTILLO UÑA / MARTEAU D'EMBALLER / CLAW HAMMER / MARTELLO / MARTELO DE UNHA



Ref		$\varnothing$			
0951 5111	620 g	25 mm	1	6	<b>10,03</b>
0951 5112	720 g	27 mm	1	6	<b>10,46</b>



MACETA DE GOMA / MARTEAU EN CAOUTCHOUC / RUBBER HAMMER / MAZZETTA IN GOMMA / MAÇO DE BORRACHA



Ref				
0951 5135	340 g	1	6	<b>6,55</b>
0951 5136	680 g	1	6	<b>8,83</b>
0951 5137	900 g	1	6	<b>10,07</b>

PICO DE CAVAR / PIOCHE / DIGGER PICK / PICCONE PER SCAVARE / PICADEIRA

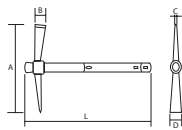

Ref		A	B	C	D			
0951 7074	500 g	237 mm	41 mm	6 mm	35 mm	385 mm	1	<b>15,26</b>

MAZA CUADRADA MANGO LARGO / MASE CARREE / STONING HAMMER / MAZZA QUADRATA MANICO LUNGO / MARRETA QUADRADA



Ref				
0951 5056	3000 g	1	6	<b>41,23</b>
0951 5057	4000 g	1	6	<b>48,91</b>
0951 5058	5000 g	1	6	<b>57,14</b>

MAZA CUÑA (MANGO FIBRA DE VIDRIO) / MASSE COIN (MANGUE FIBRE DE VERRE) / WEDGE HAMMER (FIBERGLASS HANDLE)  
 MARTELLO A CUNEO (MANICO IN FIBRA DI VETRO) / MARTELO DE CUNHA (CABO FIBRA DE VIDRO)

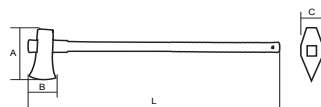

Ref	A	B	C				
0951 4097	204 mm	65 mm	55 mm	900 mm	2700 g	1	<b>44,05</b>



MARTILLO DE NYLON/PU / MARTEAU NYLON/PU / NYLON HAMMER/PU / MARTELO IN NYLON/PU / MARTELO DE NYLON/PU



Ref	∅			
0951 5040	28 mm	1	6	13,94
0951 5041	35 mm	1	6	15,38
0951 5042	45 mm	1	6	21,69

**A**

**B**



Nylon

PU

Recambio / Rechange / Spare parts / Pieces de rechange / Recarga

Ref		∅		
0951 5040.2	A	28 mm	1	1,57
0951 5040.3	B	28 mm	1	1,57
0951 5041.2	A	35 mm	1	2,16
0951 5041.3	B	35 mm	1	2,00
0951 5042.2	A	45 mm	1	3,43
0951 5042.3	B	45 mm	1	3,19

MARTILLO UÑA CABEZA CUADRADA / MASE CARREE / CLAW HAMMER / MAZZA QUADRATA MANICO LUNGO / MARTELO DE UNHA BASE QUADRADA



Ref				
0951 5150	400 g	1	6	24,95

MARTILLO ALEMÁN / MARTEAU MÉCANICIEN / MACHINIST HAMMER / MARTELO DA MECCANICO / MARTELO TIPO ALEMÃO



Ref				
0951 5120	200 g	1	6	7,62
0951 5121	300 g	1	6	9,24
0951 5122	400 g	1	6	10,10
0951 5123	500 g	1	6	11,51
0951 5124	600 g	1	6	12,47
0951 5125	800 g	1	6	16,06
0951 5126	1000 g	1	6	17,32



DINAMOMÉTRICA PROFESIONAL / DYNAMOMETRIQUE PROFESSIONNEL / PROFESSIONAL TORQUE WRENCH  
 CHIAVE DINAMOMETRICA PFESSIONALE / CHAVE DE TORQUE-BINÁRIO PROFISSIONALL



ES Llave dinamométrica de alta precisión con características inigualables en seguridad y confort. Carraca de 48 dientes que permite un ángulo de oscilación ideal de 7,5°, proporcionando tanto un ajuste preciso como un uso antideslizante. Cuadrillo de acero Cr-Mo. Llave dinamométrica ligera, con empuñadura de fácil agarre y visor para la lectura clara del valor fijado. Precisión de lectura de +/- 4%, fabricado según el estándar ISO 9000.

FR Clé dynamométrique haute précision, avec caractéristiques uniques en sécurité et confort. 48 dents à cliquet permettant un angle d'engagement de 7,5° qui est idéal; permet un réglage précis sans glissement. Embout carré en alliage d'acier chrome-molybdène. Léger avec une poignée de confort et une lentille pour une lecture claire de la valeur de consigne. Précis à +/- 4% de la lecture. En accord avec ISO 9000.

EN High Accuracy Torque Wrench, with unmatched features, safety & comfort. 48 th Ratchet allows for an engagement angle of 7-1/2° which is ideal providing both precise adjustment & non slip use. Cr-Mo Steel Square Drive. Lightweight with a comfort grip handle & lens for clear reading or the set value. Accurate to +/- 4% or reading, manufactured to ISO 9000 standard. Fully Serviceable.

IT Chiave dinamometrica ad alta precisione con caratteristiche ineguagliabili in sicurezza e confort. Cricchetto da 48 denti che consente un angolo di oscillazione ideale da 7,5°, consentendo sia una regolazione precisa che un utilizzo antiscivolo. Quadrillo in acciaio Cr-Mo. Chiave dinamometrica leggera, con impugnatura di facile presa e display per una lettura chiara del valore impostato. Precisione di lettura + 4%, in conformità con la ISO 9000.

PT Dinamômetro profissional de alta precisão, com características incomparáveis em segurança e conforto. A catraca de 48 dentes permite um ângulo de inclinação ideal de 7,5°, proporcionando um ajuste preciso e um uso antiderrapante. Quadrado de liga de aço cromo-molibdênio. Chave dinamométrica leve, com punho aderente e visor para a leitura clara do valor ajustado. Precisão de leitura +/- 4%. De acordo com a norma ISO 9000.

Ref	Nm			
0951 2091	5 - 25	3/8"	1	186,30
0951 2092	20 - 100	1/2"	1	198,45
0951 2093	40 - 200	1/2"	1	198,45
0951 2094	60 - 340	1/2"	1	243,00
0951 2095	150 - 750	3/4"	1	719,40
0951 2096	200 - 1000	1"	1	992,25

EXPOSITOR METAL PARA DINAMOMÉTRICAS 6 UDS / PRESENTOIR METAL POUR DYNAMOMETRIQUES 6 UNITES  
 METAL DISPLAY FOR TORQUE WRENCHES 6 PCS / ESPOSITORE IN METALLO PER DINAMOMETRI 6 PCS  
 EXPOSITOR DE METAL P/ DINAMÓMETROS 6 UDS



Sólo expositor  
 Only display

Ref	A	B	C		
0951 9999	900 mm	200 mm	460 mm	1	121,50



DINAMOMÉTRICA DIGITAL + MANÓMETRO / DYNAMOMETRIQUE NUMÉRIQUE + MANOMÈTRE / DIGITAL TORQUE ADAPTOR + TYRE GAUGE  
 CHIAVE DINAMOMETRICA DIGITALE + MANOMETRO / DINAMOMETRICA DIGITAL + MANÓMETRO

1-100 PSI (PRESIÓN/PRESSUERE)

1/2"

40-200 Nm

ISO 6789



ES Dinamométrica digital que incluye un manómetro incorporado. Una herramienta imprescindible para todo mecánico. Memoria que puede almacenar hasta 50 lecturas. Gran pantalla LCD de fácil lectura con retroiluminación y una precisión de 0,1. Indicador luminoso y sonoro con 3 luces led que cambian de verde a rojo cuando alcanza el nivel de par deseado. Medidor de presión en 5 unidades: PSI, Kpa, Bar, kg/cm<sup>2</sup> y Nm. Pilas: 2 AAA.

FR Clé dynamométrique numérique qui incorpore un manomètre. Il est un outil indispensable pour les mécaniciens. Mémoire intégrée pour un maximum de 50 lectures. Un grand écran facile à lire avec de rétroéclairage et une précision de 0,1. Indicateur lumineux et sonore avec 3 voyants LED qui changent de couleur vert à rouge lorsque atteint le niveau de couple souhaité. Manomètre en 5 unités de mesure de pression : psi, kPa, bar, kg/cm<sup>2</sup> et Nm. 2 piles AAA.

EN Electronic torque wrench with an integrated tyre gauge. It is an essential tool for every mechanic. Built-in memory for 50 different readings. Large & easy-to-read LCD display with backlight and a 0.1 accuracy. Sound/light indicator with 3 LED changeable lights from green to red as the desired torque level is reached. The unit of pressure of our pressure gauge is displayed in "PSI", "Kpa", "Bar", "kg/cm<sup>2</sup>" & "Nm". 2 AAA Batteries.

IT Chiave dinamometrica digitale compresa nel manometro incorporato. È uno strumento essenziale per ogni meccanico. Memoria incorporata per 50 differenti letture. Display LCD ampio di facile lettura con retroilluminazione e precisione di 0,1. Indicatore luminoso e sonoro con 3 luci LED che cambiano colore da verde a rosso quando si raggiunge il livello di torque desiderato. Manometro in 5 unità di misura della pressione: psi, bar, Kpa, kg/cm<sup>2</sup> e Nm. 2 batterie AAA.

PT Dinamometrica digital que inclui um manómetro incorporado. É uma ferramenta imprescindível para qualquer mecânico. Memória interna para armazenar 50 leituras. Mostrador grande de fácil leitura com retroiluminação e precisão de 0,1. Indicador sonoro/lumínico com 3 luzes LED que mudam de cor verde a vermelho quanto for atingido o nível desejado. Manómetro em 5 unidades de pressão: psi, bar, Kpa, kg/cm<sup>2</sup> e Nm. 2 pilhas AAA

Ref	Nm			
0951 2090	40 - 200	1/2"	1	157,50

LLAVES FIJAS DOBLE BOCA / CLÉS À FOURCHES / OPEN-END WRENCHES / CHIAVI FISSE / CHAVES FIXAS DUPLA BOCA



Ref						
0960 1001	6x7	30 g	1	10	1,85	✓
0960 1002	8x9	45 g	1	10	2,01	✓
0960 1003	10x11	56 g	1	10	2,27	✓
0960 1004	12x13	76 g	1	10	2,67	✓
0960 1005	14x15	94 g	1	10	3,36	✓
0960 1006	16x17	114 g	1	10	4,33	✓
0960 1007	18x19	157 g	1	5	5,44	✓
0960 1008	20x22	223 g	1	5	6,31	✓
0960 1009	21x23	223 g	1	5	7,60	✓
0960 1010	24x26	336 g	1	5	9,47	✓
0960 1011	25x28	356 g	1	5	10,43	✓
0960 1012	27x29	431 g	1	5	12,35	✓
0960 1013	30x32	553 g	1	5	13,59	✓
0960 1014	34x36	558 g	1	5	14,66	✓
0960 1015	36x38	650 g	1	5	15,86	✓
0960 1016	41x46	990 g	1	4	19,28	✓
0960 1017	50x55	870 g	1	2	37,40	✓
0960 1018	55x60	1982 g	1	2	51,70	✓

SET LLAVES FIJAS DOBLE BOCA / CLÉS À FOURCHES / KIT OF OPEN-END WRENCHES / SET CHIAVI FISSE / JOGO DE CHAVES FIXAS DUPLA BOCA



Ref				
0960 1050	6 pcs	6x7; 8x9; 10x11; 12x13; 14x15; 16x17	1	20,54
0960 1051	8 pcs	6x7; 8x9; 10x11; 12x13; 14x15; 16x17; 18x19; 20-22	1	26,72
0960 1052	10 pcs	6x7; 8x9; 10x11; 12x13; 14x15; 16x17; 18x19; 20-22; 21x23; 24x26	1	50,28
0960 1053	12 pcs	6x7; 8x9; 10x11; 12x13; 14x15; 16x17; 18x19; 20x22; 21x23; 24x26; 25x28; 30x32	1	66,86





## LLAVES ABIERTAS PARA RACORES / POLYAGONALES FENDUES / FLARE NUT / CHIAVE PER RACCORDI / CHAVE ABERTA PARA CONEXÃO



Ref	📏	📦	📦	📦
0951 2040	8x10	1	10	25,89
0951 2041	9x11	1	10	27,21
0951 2042	10x11	1	10	28,32
0951 2043	11x13	1	10	28,37
0951 2044	12x14	1	10	31,38
0951 2045	17x19	1	10	39,03
0951 2046	19x22	1	5	39,92
0951 2047	22x24	1	5	48,30
0951 2048	24x27	1	5	55,50
0951 2049	30x32	1	5	71,53

## LLAVES COMBINADAS / CLÉS MIXTES / COMBINATION WRENCHES / CHIAVI COBINATE / CHAVES BOCA-LUNETETA



Ref	📏	📦	📦	📦	📦	📦	Ref	📏	📦	📦	📦	📦	📦	📦
0960 2001	6	19 g	1	10	1,78	✓	0960 2021	26	389 g	1	5	9,74	✓	
0960 2002	7	27 g	1	10	2,01	✓	0960 2022	27	411 g	1	5	11,80	✓	
0960 2003	8	50 g	1	10	2,06	✓	0960 2023	28	921 g	1	5	12,83	✓	
0960 2004	9	32 g	1	10	2,12	✓	0960 2024	29	450 g	1	5	14,68	✓	
0960 2005	10	44 g	1	10	2,27	✓	0960 2025	30	542 g	1	5	14,68	✓	
0960 2006	11	52 g	1	10	2,33	✓	0960 2026	32	640 g	1	5	15,71	✓	
0960 2007	12	69 g	1	10	2,54	✓	0960 2027	33	919 g	1	2	25,32	✓	
0960 2008	13	78 g	1	10	2,82	✓	0960 2028	34	963 g	1	2	25,32	✓	
0960 2009	14	99 g	1	10	3,02	✓	0960 2029	35	1139 g	1	2	31,57	✓	
0960 2010	15	98 g	1	10	3,36	✓	0960 2030	36	1130 g	1	2	32,60	✓	
0960 2011	16	118 g	1	10	3,91	✓	0960 2031	38	1363 g	1	2	37,20	✓	
0960 2012	17	135 g	1	10	4,25	✓	0960 2032	40	1342 g	1	2	39,88	✓	
0960 2013	18	182 g	1	5	4,80	✓	0960 2033	41	1678 g	1	2	39,90	✓	
0960 2014	19	202 g	1	5	5,28	✓	0960 2034	42	1690 g	1	2	44,93	✓	
0960 2015	20	229 g	1	5	5,70	✓	0960 2035	43	1635 g	1	2	45,65	✓	
0960 2016	21	277 g	1	5	6,25	✓	0960 2036	44	1975 g	1	2	53,33	✓	
0960 2017	22	214 g	1	5	7,00	✓	0960 2037	46	2034 g	1	2	60,22	✓	
0960 2018	23	273 g	1	5	8,03	✓	0960 2038	48	2082 g	1	2	72,21	✓	
0960 2019	24	285 g	1	5	8,31	✓	0960 2039	50	2595 g	1	2	73,52	✓	
0960 2020	25	361 g	1	5	9,00	✓								

## SET LLAVES COMBINADAS / CLÉS MIXTES / KIT OF COMBINATION WRENCHES / SET CHIAVI COBINATE / JOGO DE CHAVES DE BOCA-LUNETETA



Ref	📦	📏	📦	📦
0960 2050	6 pcs	8, 10, 12, 14, 17, 19	1	24,02
0960 2051	8 pcs	8, 10, 12, 13, 14, 17, 19, 22	1	33,71
0960 2052	10 pcs	8, 9, 10, 11, 12, 13, 14, 17, 19, 22	1	43,58
0960 2053	12 pcs	6, 7, 8, 9, 10, 11, 12, 13, 14, 15, 16, 17	1	37,68
0960 2054	17 pcs	6, 7, 8, 9, 10, 11, 12, 13, 14, 15, 16, 17, 18, 19, 20, 21, 22	1	66,40
0960 2055	26 pcs	6, 7, 8, 9, 10, 11, 12, 13, 14, 15, 16, 17, 18, 19, 20, 21, 22, 23, 24, 25, 26, 27, 28, 29, 30, 32	1	150,25



LLAVE COMBINADA ARTICULADA 180° DE CARRACA / CLÉ MIXTE À CLIQUET ARTICULÉE / FLEXIBLE COMBINATION GEAR WRENCH 180°  
CHIAVE COMBINATA ARTICULATA 180° A CRICCHETTO / CHAVE COMBINADA ARTICULADA 180° DE CARRACA



**Cr/V  
STEEL**      **72  
TEETH**

Ref	⬡	↔	📦	📦	📦	📦
0966 08140	8	140 mm	1	25	13,55	✓
0966 09150	9	150 mm	1	25	13,69	✓
0966 10160	10	160 mm	1	25	14,04	✓
0966 11165	11	165 mm	1	25	14,58	✓
0966 12170	12	170 mm	1	25	15,07	✓
0966 13178	13	178 mm	1	25	15,61	✓
0966 14190	14	190 mm	1	25	16,33	✓
0966 15200	15	200 mm	1	25	17,17	✓
0966 16208	16	208 mm	1	10	17,89	✓
0966 17228	17	228 mm	1	10	18,74	✓
0966 18238	18	238 mm	1	10	19,41	✓
0966 19248	19	248 mm	1	10	19,95	✓
0966 20248	10	248 mm	1	10	20,30	✓
0966 21290	21	290 mm	1	10	32,78	✓
0966 22290	22	290 mm	1	10	32,78	✓
0966 23320	23	320 mm	1	10	39,88	✓
0966 24320	24	320 mm	1	10	39,88	✓

LLAVES ESTRELLA PLANA / POLYAGONALE A DROITE / FLAT DOUBLE ENDED RING SPANNER / STELLA PIANA / CHAVES LUNETA PLANA



Ref	⬡	📦	📦	📦	📦
0951 2001	6x7	1	10	1,48	✓
0951 2002	8x9	1	10	1,60	✓
0951 2003	10x11	1	10	1,85	✓
0951 2004	12x13	1	10	2,06	✓
0951 2005	14x15	1	10	2,22	✓
0951 2006	16x17	1	10	2,54	✓
0951 2007	17x19	1	10	2,97	✓
0951 2008	18x19	1	10	3,91	✓
0951 2009	20x22	1	5	4,45	✓
0951 2010	21x23	1	5	4,70	✓
0951 2011	24x27	1	5	9,38	✓
0951 2012	25x28	1	5	11,69	✓
0951 2013	30x32	1	5	13,15	✓

SET DE 8 LLAVES ESTRELLA PLANA / SET POLYAGONALE A DROITE 8 UNITES / SET OF 8 FLAT DOUBLE RING SPANNERS  
SET 8 PEZZI POLIGONALE DIRITTA / JOGO DE 8 CHAVES LUNETA PLANA



Ref	📦	↓	📦	📦
0950 4056	8 pcs	6x7, 8x9, 10x11, 12x13, 14x15, 16x17 18x19, 21x23	1	40,44



## LLAVES DE MEDIA LUNA / DEMI-LUNE / HALF MOON / A MEZZA LUNA / CHAVE CURVA LUNETA



Ref			
0951 2050	11x13	1	22,16
0951 2051	13x17	1	24,87
0951 2052	14x17	1	24,87
0951 2053	19x22	1	29,60

## LLAVES ESTRELLA ACODADAS / CLÉS POLIGONALES / DOUBLE OFFSET RING WRENCHES / CHIAVI A GOMITO / CHAVE LUNETA



Ref						
0960 3001	6x7	50 g	1	10	3,22	✓
0960 3002	8x9	65 g	1	10	3,57	✓
0960 3003	10x11	85 g	1	10	3,85	✓
0960 3004	12x13	110 g	1	10	4,12	✓
0960 3005	14x15	140 g	1	10	4,73	✓
0960 3006	16x17	180 g	1	5	5,49	✓
0960 3007	18x19	225 g	1	5	6,45	✓
0960 3008	20x22	360 g	1	5	9,13	✓
0960 3009	21x23	400 g	1	5	9,82	✓
0960 3010	24x26	490 g	1	5	11,80	✓
0960 3011	25x28	450 g	1	5	12,63	✓
0960 3013	27x29	600 g	1	5	15,14	✓
0960 3014	30x32	700 g	1	5	19,40	✓
0960 3015	36x41	1080 g	1	2	29,71	✓
0960 3016	46x50	1970 g	1	1	88,89	✓
0960 3017	55x60	3510 g	1	1	125,35	✓
0960 3018	65x70	4950 g	1	1	267,40	✓

SET LLAVES ESTRELLA ACODADAS / CLÉS POLIGONALES / KIT OF DOUBLE OFFSET RING WRENCHES  
SET CHIAVI A GOMITO / JOGO DE CHAVES LUNETA

Ref				
0960 3050	6 pcs	6x7; 8x9; 10x11; 12x13; 14x15; 16x17	1	29,79
0960 3051	8 pcs	6x7; 8x9; 10x11; 12x13; 14x15; 16x17; 18x19; 20x22	1	39,33
0960 3052	10 pcs	6x7; 8x9; 10x11; 12x13; 14x15; 16x17; 18x19; 20x22; 21x23; 24x26	1	54,90
0960 3053	12 pcs	6x7; 8x9; 10x11; 12x13; 14x15; 16x17; 18x19; 20x22; 21x23; 24x26; 25x28; 30x32	1	84,35



## LLAVE ARTICULADA EN "T" / CLÉ ARTICULÉE EN T / JOINTED WRENCH / CHIAVE A SNODO / CHAVE ARTICULADA

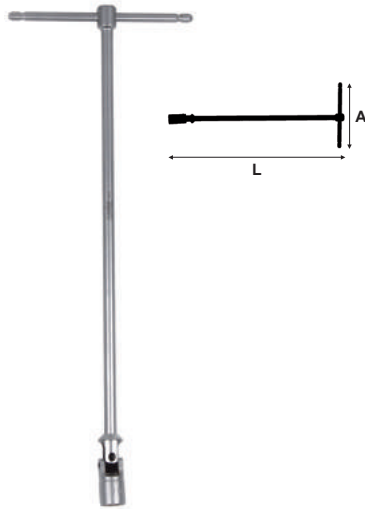

Ref	⬡	L	A	📦	📦
0951 3241	6 mm	390 mm	165 mm	1	39,05
0951 3242	7 mm	390 mm	165 mm	1	39,13
0951 3243	8 mm	390 mm	165 mm	1	44,94
0951 3244	9 mm	390 mm	165 mm	1	39,88
0951 3245	10 mm	450 mm	180 mm	1	50,30
0951 3246	11 mm	450 mm	180 mm	1	49,42
0951 3247	12 mm	450 mm	180 mm	1	48,22
0951 3248	13 mm	450 mm	180 mm	1	56,78
0951 3249	14 mm	450 mm	180 mm	1	53,92
0951 3250	15 mm	500 mm	180 mm	1	59,78
0951 3251	16 mm	500 mm	180 mm	1	60,66
0951 3252	17 mm	500 mm	180 mm	1	64,26
0951 3253	18 mm	500 mm	180 mm	1	59,42
0951 3254	19 mm	500 mm	230 mm	1	73,95
0951 3255	20 mm	500 mm	230 mm	1	72,63
0951 3256	21 mm	500 mm	230 mm	1	75,75
0951 3257	22 mm	500 mm	230 mm	1	73,97
0951 3259	24 mm	500 mm	230 mm	1	76,83

LLAVE COMBINADA CON CARRACA REVERSIBLE / CLÉ MIXTE A CLIQUET RÉVERSIBLE / REVERSIBLE COMBINATION RATCHET WRENCHES  
CHIAVI MISTE CON CRICCHETTO REVERSIBILE / CHAVES COMBINADAS COM ROQUETE REVERSÍVEL

ES Su innovador diseño de estrella permite apretar múltiples y diferentes cabezas de tornillo, tales como Spherical, 6 lados, 12 lados, E-Torx y cuadrados, incluso en cabezas redondeadas hasta en un 50% por el desgaste.

FR Son design novateur en étoile, permet de serrer de multiples et différentes têtes de vissage, telles que sphériques, 6 pans, 12 pans, E-Torx et carrées, y compris des têtes arrondies à 50% par usure.

EN Innovative box drive allows to tighten multiple nut heads such as Spherical, 6-point, 12-point, Square and E-Torx, as well as with 50% rounded off nuts.

IT Il suo innovativo disegno a stella permette di serrare con la stessa chiave molteplici teste viti: esagonali, dodecagonali, Torx e quadrate. Permette inoltre il serraggio di teste viti arrotondate dall'usura, fino ad un 50%.

PT O seu desenho de estrela permite apertar múltiplas e diferentes cabeças de parafusos, tais como spherical, 6 lados, 12 lados, E-torx e quadrados, inclusive cabeças redondas até 50% de desgaste.

Ref	⬡	📦	📦	📦	📦	📦
0951 2020	8	50 g	1	5	14,82	✓
0951 2021	9	55 g	1	5	13,99	✓
0951 2022	10	60 g	1	5	14,66	✓
0951 2023	11	80 g	1	5	14,77	✓
0951 2024	12	87 g	1	5	16,48	✓
0951 2025	13	100 g	1	5	16,74	✓
0951 2026	14	120 g	1	5	17,99	✓
0951 2027	15	130 g	1	5	18,15	✓
0951 2028	16	150 g	1	5	18,62	✓
0951 2029	17	180 g	1	5	22,05	✓
0951 2030	18	204 g	1	5	22,46	✓
0951 2031	19	240 g	1	5	23,87	✓
0951 2032	21	310 g	1	5	38,38	✓
0951 2033	22	340 g	1	5	38,48	✓
0951 2034	24	450 g	1	5	33,38	✓
0951 2035	27	610 g	1	5	45,14	✓

SET DE 8 LLAVES CARRACA REVERSIBLE / SET 8 CLÉ A CLIQUET RÉVERSIBLE / SET OF 8 RATCHET WRENCHES  
SET 8 CHIAVI CRICCHETTO REVERSIBILE / JOGO DE 8 CHAVES ROQUETE REVERSÍVEL

Ref	📦	📦	📦	📦
0950 4055	8 pcs	8, 10, 12, 13, 14, 17, 19, 21	1	162,10



LLAVES DE PIPA ABIERTAS / CLÉS A PIPE DÉBOUCHÉES / ANGLED OPEN SOCKET / CHIAVI A PIPA APERTA / CHAVES DE PIPA ABERTAS



Ref	⊕	📦	📦	📦	📦
0951 2330	6 mm	1	5	4,60	✓
0951 2331	7 mm	1	5	5,25	✓
0951 2332	8 mm	1	5	4,80	✓
0951 2333	9 mm	1	5	4,85	✓
0951 2334	10 mm	1	5	5,50	✓
0951 2335	11 mm	1	5	5,90	✓
0951 2336	12 mm	1	5	5,95	✓
0951 2337	13 mm	1	5	6,95	✓
0951 2338	14 mm	1	5	7,05	✓
0951 2339	15 mm	1	5	9,10	✓
0951 2340	16 mm	1	5	9,50	✓
0951 2341	17 mm	1	5	9,75	✓
0951 2342	18 mm	1	5	10,05	✓
0951 2343	19 mm	1	5	11,90	✓
0951 2344	20 mm	1	5	12,90	✓
0951 2345	21 mm	1	5	14,55	✓
0951 2346	22 mm	1	5	13,40	✓
0951 2347	23 mm	1	1	16,95	✓
0951 2348	24 mm	1	1	17,50	✓
0951 2349	25 mm	1	1	21,20	✓
0951 2350	26 mm	1	1	22,60	✓
0951 2351	27 mm	1	1	25,74	✓
0951 2352	28 mm	1	1	30,66	✓
0951 2353	29 mm	1	1	32,38	✓
0951 2354	30 mm	1	1	34,21	✓
0951 2355	32 mm	1	1	35,76	✓

SETS DE 8, 10 Ó 17 LLAVES DE PIPA ABIERTAS / SET CLÉS A PIPE DÉBOUCHÉES 8, 10 ET 17 UNITÉS / SET OF 8, 10 OR 17 ANGLED OPEN SOCKETS  
SET DA 8, 10 O 17 CHIAVI A PIPA / JOGO DE CHAVES DE PIPA ABIERTAS 8, 10 E 17 CHAVES



Ref	📦	⬇️	📦	📦
0950 4050	8 pcs	8, 9, 10, 11, 12, 13, 14, 17	1	55,40
0950 4051	10 pcs	8, 9, 10, 11, 12, 13, 14, 17, 19, 21	1	85,90
0950 4052	17 pcs	6, 7, 8, 9, 10, 11, 12, 13, 14, 15, 16, 17, 18, 19, 20, 21, 24	1	149,35





LLAVES DE TUBO DOBLE BOCA / EN TUBE DROITE FORGÉE / TUBULAR SPANNER  
 CHIAVI A TUBO A DOPPIA BOCCA / CHAVE TUBULAR DE DUPLA BOCA



Ref					
0951 2300	6x7	1	10	9,54	✓
0951 2301	8x9	1	10	9,80	✓
0951 2302	10x11	1	10	10,14	✓
0951 2303	12x13	1	10	12,05	✓
0951 2304	14x15	1	10	14,00	✓
0951 2305	16x17	1	10	15,17	✓
0951 2306	18x19	1	10	19,08	✓
0951 2307	20x22	1	10	20,25	✓
0951 2308	21x23	1	10	23,50	✓
0951 2309	24x26	1	10	26,56	✓
0951 2310	25x28	1	10	28,56	✓
0951 2311	27x29	1	10	28,56	✓
0951 2312	30x32	1	10	36,45	✓



Ref			
0950 4044	6x19	1	3,74
0950 4045	20x32	1	4,83

JUEGOS LLAVES DE TUBO (8 Y 12 PIEZAS) / KIT CLÉS EN TUBE (8 ET 12 UNITÉS) / SET OF TUBULAR SPANNERS (8 AND 12 UNITS)  
 KIT CHIAVI A TUBO (8 E 12 PEZZI) / JOGO DE CHAVES TUBULARES (8 E 12 PEÇAS)



Ref				
0950 4042	8 pcs	6x7; 8x9; 10x11; 12x13; 14x15; 16x17; 18x19; 20x22	1	109,90
0950 4043	12 pcs	6x7; 8x9; 10x11; 12x13; 14x15; 16x17; 18x19; 20x22; 21x23; 24x26; 25x28; 30x32	1	198,20

LLAVE DE CARRACA 1/4" / CLIQUET RÉVERSIBLE / REVERSIBLE RATCHET HANDLE / CHIAVE A CRICCHETTO / CHAVE DE CATRACA

1/4"



Ref						
0951 3204	1/4"	160 g	1	6	17,37	✓

1/4" MÉTRICA "mm" - VASO LARGO / METRIQUE - DOUILLE LONGUE / METRIC - LONG SOCKET  
 METRICA - BRUGOLE LUNGHE / MÉTRICA - SOQUETE LONGO

1/4" LONG

6 Caras / 6 Faces / 6 Point / 6 Facce / 6 Lados



Ref	M				Ref	M			
1400 8187	6 mm	1	2,35	✓	1400 8191	10 mm	1	2,35	✓
1400 8188	7 mm	1	2,35	✓	1400 8192	11 mm	1	2,35	✓
1400 8189	8 mm	1	2,35	✓	1400 8193	12 mm	1	2,35	✓
1400 8190	9 mm	1	2,35	✓	1400 8194	13 mm	1	2,35	✓



1/4" MÉTRICA "mm" - VASO / METRIQUE - DOUILLE / METRIC - SOCKET / METRICA - BRUGOLE / MÉTRICA - SOQUETES

1/4"

6 Caras / 6 Faces / 6 Point / 6 Facce / 6 Lados



Ref	M					Ref	M				
0951 3000	4 mm	1	10	2,45	✓	0951 3005	9 mm	1	10	2,45	✓
0951 3001	5 mm	1	10	2,45	✓	0951 3006	10 mm	1	10	2,45	✓
0951 3012	5,5 mm	1	10	2,45	✓	0951 3007	11 mm	1	10	2,45	✓
0951 3002	6 mm	1	10	2,45	✓	0951 3008	12 mm	1	10	2,45	✓
0951 3003	7 mm	1	10	2,45	✓	0951 3009	13 mm	1	10	2,45	✓
0951 3004	8 mm	1	10	2,45	✓	0951 3010	14 mm	1	10	2,45	✓

TORX 1/4" - VASO HEMBRA / DOUILLE FEMELLE / SOCKET FEMALE / BUSSOLA FEMMINA / SOQUETE FÊMEA

1/4"



Ref	M			
1400 8201	E - 4	1	2,35	✓
1400 8202	E - 5	1	2,35	✓
1400 8203	E - 6	1	2,35	✓
1400 8204	E - 7	1	2,35	✓
1400 8205	E - 8	1	2,35	✓
1400 8206	E - 10	1	2,35	✓
1400 8207	E - 11	1	2,35	✓

ARTICULACIÓN UNIVERSAL 1/4" / CARDAN UNIVERSEL / UNIVERSAL JOINT / SNODO UNIVERSALE / ARTICULAÇÃO UNIVERSAL

1/4"



Ref				
0951 3226	1/4"	1	5	6,40

MANGO CORREDIZO EN "T" 1/4" / POIGNÉE COULISSANTE / SLIDING "T" HANDLE / MANICO SCORREVOLE A "T" / CABO DE CORRER EM "T"

1/4"



Ref				
0951 3209	1/4"	1	5	6,55

ADAPTADOR PORTA VASOS DE 1/4" / ADAPTATEUR PORTE DOUILLES / NUT DRIVER SOCKETS  
ADATTATORE PORTA BUSSOLE / ADAPTADOR PARA SOQUETES

1/4"



Ref				
0952 9995	25 mm	1	4,07	✓
0952 9996	50 mm	1	5,77	✓



ALARGADERA 1/4" / RALLONGE / EXTENSION / PROLUNGA / EXTENSÃO

1/4"



Ref				
0951 3215	1/4" x 51 mm	1	5	4,90
0951 3216	1/4" x 153 mm	1	5	5,10

ADAPTADOR VASOS 1/4 - 3/8" / SOCKET ADAPTER 1/4 - 3/8"



Ref				
0951 3011	1/4 - 3/8" mm	1	10	10,02

EXTENSIÓN FLEXIBLE 1/4" / EXTENSION FLEXIBLE / FLEXIBLE EXTENSION / PROLUNGA FLESSIBILE / EXTENSÃO FLEXÍVEL

1/4"



Ref				
1400 8250	1/4" x 150 mm	1	10	3,74

LLAVE DE CARRACA 3/8" / CLIQUET RÉVERSIBLE / REVERSIBLE RATCHET HANDLE / CHIAVE A CRICCHETTO / CHAVE DE CATRACA

3/8"



Ref					
0951 3205	3/8"	1	10	21,22	✓

3/8" MÉTRICA "mm" - VASO / METRIQUE - DOUILLE / METRIC - SOCKET / METRICA - BRUGOLE / MÉTRICA - SOQUETE

3/8"



6 Caras / 6 Faces / 6 Point / 6 Facce / 6 Lados

Ref	M				Ref	M			
0951 3022	8 mm	1	10	2,55	0951 3030	16 mm	1	10	2,55
0951 3023	9 mm	1	10	2,55	0951 3031	17 mm	1	10	2,70
0951 3024	10 mm	1	10	2,55	0951 3032	18 mm	1	10	2,70
0951 3025	11 mm	1	10	2,55	0951 3033	19 mm	1	10	2,70
0951 3026	12 mm	1	10	2,55	0951 3034	20 mm	1	10	2,70
0951 3027	13 mm	1	10	2,55	0951 3035	21 mm	1	10	2,70
0951 3028	14 mm	1	10	2,55	0951 3036	22 mm	1	10	2,70
0951 3029	15 mm	1	10	2,55					



ALARGADERA 3/8" / RALLONGE / EXTENSION / PROLUNGA / EXTENSÃO

3/8"



Ref				
0951 3217	3/8" x 127 mm	1	5	6,30
0951 3218	3/8" x 254 mm	1	5	7,85

MANGO CORREDIZO EN "T" 3/8" / POIGNEE COULISSANTE / SLIDING "T" HANDLE / MANICO SCORREVOLE A "T" / CABO DE CORRER EM "T"

3/8"



Ref				
0951 3210	3/8"	1	5	6,76

ARTICULACIÓN UNIVERSAL 3/8" / CARDAN UNIVERSEL / UNIVERSAL JOINT / SNODO UNIVERSALE / ARTICULAÇÃO UNIVERSAL

3/8"



Ref				
0951 3227	3/8"	1	5	31,00

ADAPTADOR VASOS 3/8" / ADAPTATEUR DOUILLES / SOCKET ADAPTER / ADATTATORE BUSSOLA / ADAPTADOR SOQUETES



Ref				
0951 3020	3/8" - 1/4"	1	5	12,23



Ref				
0951 3021	3/8" - 1/2"	1	5	12,85



LLAVE DE CARRACA GIRATORIA 360° / CLE DE CLIQUET ROTATIVE 360° / SWIVEL RATCHET WRENCH 360°  
 CHIAVE A CRICCHETTO GIREVOLE 360° / CHAVE DE ROQUETE ROTATIVA 360°



Ref	Nm				
0951 3261	5 - 25	1/4"	1	6	44,46
0951 3262	20 - 100	1/2"	1	6	70,72

CARRACA DUAL DOBLE ACCIÓN 52 DIENTES / CLIQUET DUAL DOUBLE ACTION 52 DENTS / DUAL RATCHET DOUBLE ACTION 52 TEETH  
 CRICCHETTO DOPPIA AZIONE 52 DENTI / CARRACA DUAL DUPLA ACÇÃO 52 DIENTES



Botón de liberación rápida  
 Quick release push button  
 Mecanismo intercambiable de uso fácil  
 Easy use switch mechanism  
 Fabricado en Cromo/Vanadio  
 Chrome Vanadium Construction

Cabezal cuadrado de Cromo Molibdeno  
 Chrome Molybdenum Square Drive

Mango bimateria  
 Dual material Super Grip

Ref						
0951 3267	1/4"	52	1	6	73,01	✓
0951 3269	1/2"	52	1	6	92,66	✓

LLAVE DE CARRACA 1/2" / REVERSIBLE RATCHET HANDLE

1/2"



Ref					
0951 3206	1/2"	1	6	23,82	✓





½" MÉTRICA "mm" - VASO / MÉTRIQUE - DOUILLE / METRIC - SOCKET / METRICA - BRUGOLE / MÉTRICA - SOQUETE

1/2"

6 Caras / 6 Faces / 6 Point / 6 Facce / 6 Lados



Ref	M			
0951 3063	8 mm	1	4,06	✓
0951 3064	9 mm	1	4,06	✓
0951 3065	10 mm	1	4,06	✓
0951 3066	11 mm	1	4,68	✓
0951 3067	12 mm	1	4,68	✓
0951 3068	13 mm	1	4,68	✓
0951 3069	14 mm	1	4,68	✓
0951 3070	15 mm	1	4,68	✓
0951 3071	16 mm	1	4,68	✓
0951 3072	17 mm	1	4,68	✓
0951 3073	18 mm	1	4,68	✓
0951 3074	19 mm	1	4,68	✓

Ref	M			
0951 3075	20 mm	1	5,10	✓
0951 3076	21 mm	1	5,10	✓
0951 3077	22 mm	1	5,10	✓
0951 3078	23 mm	1	5,10	✓
0951 3079	24 mm	1	5,10	✓
0951 3080	25 mm	1	5,10	✓
0951 3081	26 mm	1	5,10	✓
0951 3082	27 mm	1	5,10	✓
0951 3083	28 mm	1	6,76	✓
0951 3084	29 mm	1	6,76	✓
0951 3085	30 mm	1	6,76	✓
0951 3086	32 mm	1	6,76	✓

½" MÉTRICA "mm" - VASO / MÉTRIQUE - DOUILLE / METRIC - SOCKET / METRICA - BRUGOLE / MÉTRICA - SOQUETE

1/2"

24 Caras / 24 Faces / 24 Point / 24 Facce / 24 Lados



Ref	M				
0951 3087	8 mm	1	10	4,06	✓
0951 3088	9 mm	1	10	4,06	✓
0951 3089	10 mm	1	10	4,06	✓
0951 3090	11 mm	1	10	4,68	✓
0951 3091	12 mm	1	10	4,68	✓
0951 3092	13 mm	1	10	4,68	✓
0951 3093	14 mm	1	10	4,68	✓
0951 3094	15 mm	1	10	4,68	✓
0951 3095	16 mm	1	10	4,68	✓
0951 3096	17 mm	1	10	4,68	✓
0951 3097	18 mm	1	10	4,68	✓
0951 3098	19 mm	1	10	4,68	✓

Ref	M				
0951 3099	20 mm	1	10	5,10	✓
0951 3100	21 mm	1	10	5,10	✓
0951 3101	22 mm	1	10	5,10	✓
0951 3102	23 mm	1	5	5,10	✓
0951 3103	24 mm	1	5	5,10	✓
0951 3104	25 mm	1	5	5,10	✓
0951 3105	26 mm	1	5	5,10	✓
0951 3106	27 mm	1	5	5,10	✓
0951 3107	28 mm	1	5	6,76	✓
0951 3108	29 mm	1	5	6,76	✓
0951 3109	30 mm	1	5	6,76	✓
0951 3110	32 mm	1	5	6,76	✓

½" MÉTRICA "mm" - VASO LARGO / DOUILLE LONGUE / LONG SOCKET / BRUGOLE LUNGHE / SOQUETE LONGO

LONG 1/2"

6 Caras / 6 Faces / 6 Point / 6 Facce / 6 Lados



Ref	M				
0951 3049	10 mm	1	10	7,18	✓
0951 3050	11 mm	1	10	7,18	✓
0951 3051	12 mm	1	10	7,18	✓
0951 3052	13 mm	1	10	7,18	✓
0951 3053	14 mm	1	10	7,18	✓
0951 3054	15 mm	1	10	7,18	✓
0951 3055	16 mm	1	10	7,18	✓

Ref	M				
0951 3056	17 mm	1	10	7,18	✓
0951 3057	18 mm	1	10	7,18	✓
0951 3058	19 mm	1	10	7,18	✓
0951 3059	21 mm	1	10	7,80	✓
0951 3060	22 mm	1	10	7,80	✓
0951 3061	23 mm	1	10	7,80	✓
0951 3062	24 mm	1	10	7,80	✓

TORX 1/2" - VASO HEMBRA / DOUILLE FEMELLE / SOCKET FEMALE / BUSSOLA FEMMINA / SOQUETE FÊMEA

1/2"

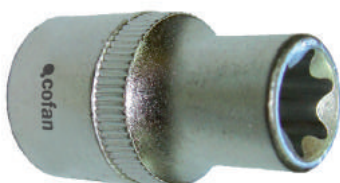

Ref	M			
1400 8208	E - 10	1	5,10	✓
1400 8209	E - 11	1	5,10	✓
1400 8210	E - 12	1	5,10	✓
1400 8211	E - 14	1	5,10	✓
1400 8212	E - 16	1	5,10	✓
1400 8213	E - 18	1	5,10	✓
1400 8214	E - 20	1	5,10	✓
1400 8215	E - 22	1	5,10	✓
1400 8216	E - 24	1	5,10	✓



MANGO CORREDIZO EN "T" 1/2" / POIGNÉE COULISSANTE / SLIDING "T" HANDLE / MANICO SCORREVOLE A "T" / CABO DE CORRER EM "T"

1/2"



Ref					
0951 3211	1/2" - 250 mm	1	5	9,95	✓

ALARGADERA 1/2" / RALLONGE / EXTENSION / PROLUNGA / EXTENSÃO

1/2"



Ref					
0951 3219	1/2" x 80 mm	1	5	10,40	✓
0951 3220	1/2" x 125 mm	1	5	11,55	✓
0951 3221	1/2" x 250 mm	1	5	12,65	✓

ARTICULACIÓN UNIVERSAL 1/2" / CARDAN UNIVERSEL / UNIVERSAL JOINT / SNODO UNIVERSALE / ARTICULAÇÃO UNIVERSAL

1/2"



Ref					
0951 3228	1/2"	1	5	10,45	✓

ALARGADERA 3/4" / RALLONGE / EXTENSION / PROLUNGA / EXTENSÃO

3/4"



Ref					
0951 3222	3/4" x 102 mm	1	5	35,02	✓
0951 3223	3/4" x 203 mm	1	5	50,47	✓



ADAPTADOR VASOS 1/2" / ADAPTATEUR DOUILLES / SOCKET ADAPTER / ADATTATORE BUSSOLA / ADAPTADOR SOQUETES



Ref				
0951 3047	1/2" - 3/8"	1	10	15,40



Ref				
0951 3048	1/2" - 3/4"	1	10	18,23

LLAVE DE CARRACA 3/4" / CLIQUET REVERSIBLE / REVERSIBLE RATCHET HANDLE / CHIAVE A CRICCHETTO / CHAVE DE CATRACA

3/4"



Ref					
0951 3207	3/4"	1	6	109,62	✓

3/4" MÉTRICA "mm" - VASO / MÉTRIQUE - DOUILLE / METRIC - SOCKET / METRICA - BRUGOLE / MÉTRICA - SOQUETE

3/4"

6 Caras / 6 Faces / 6 Point / 6 Facce / 6 Lados



Ref	M					Ref	M				
0951 3149	19 mm	1	10	14,93	✓	0951 3161	34 mm	1	10	20,61	✓
0951 3150	22 mm	1	10	14,93	✓	0951 3162	35 mm	1	10	20,61	✓
0951 3151	23 mm	1	10	15,74	✓	0951 3163	36 mm	1	10	21,82	✓
0951 3152	24 mm	1	10	15,74	✓	0951 3164	38 mm	1	10	23,77	✓
0951 3153	25 mm	1	10	15,83	✓	0951 3166	41 mm	1	10	26,09	✓
0951 3154	26 mm	1	10	16,46	✓	0951 3167	42 mm	1	10	26,09	✓
0951 3155	27 mm	1	10	17,06	✓	0951 3168	46 mm	1	10	30,80	✓
0951 3156	28 mm	1	10	19,06	✓	0951 3169	50 mm	1	10	35,32	✓
0951 3157	29 mm	1	10	19,06	✓	0951 3170	55 mm	1	10	38,19	✓
0951 3158	30 mm	1	10	19,98	✓	0951 3171	60 mm	1	10	45,60	✓
0951 3159	32 mm	1	10	19,98	✓						

MANGO CORREDIZO EN "T" 3/4" / POIGNÉE COULISSANTE / SLIDING "T" HANDLE / MANICO SCORREVOLE A "T" / CABO DE CORRER EM "T"

3/4"



Ref					
0951 3212	3/4"	1	5	48,05	✓



# Cr/V

## LLAVES DE VASO / DOUILLES / SOCKETS / BRUGOLE / SOQUETES

ADAPTADOR VASOS 3/4" / ADAPTATEUR DOUILLES / SOCKET ADAPTER / ADATTATORE BUSSOLA / ADAPTADOR SOQUETES



Ref					
0951 3147	3/4 - 1"	1	6	29,81	✓



Ref					
0951 3148	3/4 - 1/2"	1	6	23,56	✓

LLAVE DE CARRACA 1" / CLIQUET RÉVERSIBLE / REVERSIBLE RATCHET HANDLE / CHIAVE A CRICCHETTO / CHAVE DE CATRACA

1"



Ref				
0951 3208	1"	1	175,24	✓

1" MÉTRICA "mm" - VASO / METRIQUE - DOUILLE / METRIC - SOCKET / METRICA - BRUGOLE / MÉTRICA - SOQUETE

1"



Ref	M				Ref	M			
0951 3187	36 mm	1	28,37	✓	0951 3195	63 mm	1	53,20	✓
0951 3188	41 mm	1	30,89	✓	0951 3196	65 mm	1	54,50	✓
0951 3189	46 mm	1	36,82	✓	0951 3197	67 mm	1	57,93	✓
0951 3190	50 mm	1	39,94	✓	0951 3198	70 mm	1	60,53	✓
0951 3191	54 mm	1	49,50	✓	0951 3199	71 mm	1	61,46	✓
0951 3192	55 mm	1	50,86	✓	0951 3200	75 mm	1	65,73	✓
0951 3193	58 mm	1	51,48	✓	0951 3201	77 mm	1	68,02	✓
0951 3194	60 mm	1	52,21	✓	0951 3202	80 mm	1	73,06	✓



MANGO CORREDIZO EN "T" 1" / PIGNEE COULISSANTE / SLIDING "T" HANDLE / MANICO SCORREVOLE A "T" / CABO DE CORRER EM "T"

1"



Ref					
0951 3213	1"	1	2	100,18	✓

ALARGADERA 1" / RALLONGE / EXTENSION / PROLUNGA / EXTENSÃO

1"



Ref				
0951 3224	1" - 203 mm	1	43,16	✓
0951 3225	1" - 406 mm	1	67,76	✓

ARTICULACIÓN UNIVERSAL 1" / CARDAN UNIVERSEL / UNIVERSAL JOINT / SNODO UNIVERSALE / ARTICULAÇÃO UNIVERSAL

1"



Ref					
0951 3229	1"	1	6	101,10	✓

ADAPTADOR VASOS 1" / DOUILLES / SOCKET ADAPTER / ADATTATORE BUSSOLA / ADAPTADOR SOQUETES

1" - 3/4"



Ref			
0951 3186	1" - 3/4"	1	56,16





## PHILLIPS



1/4"

Ref	M				
1400 8061	PH-0	1/4"	1	3,32	✓
1400 8062	PH-1	1/4"	1	3,32	✓
1400 8063	PH-2	1/4"	1	3,32	✓
1400 8064	PH-3	1/4"	1	3,32	✓

3/8"

Ref	M				
1400 8102	PH-0	3/8"	1	4,00	✓
1400 8103	PH-1	3/8"	1	4,00	✓
1400 8104	PH-2	3/8"	1	4,00	✓
1400 8105	PH-3	3/8"	1	4,00	✓

## POZIDRIVE



1/4"

Ref	M				
1400 8065	PZ-0	1/4"	1	3,32	✓
1400 8066	PZ-1	1/4"	1	3,32	✓
1400 8067	PZ-2	1/4"	1	3,32	✓
1400 8068	PZ-3	1/4"	1	3,32	✓

3/8"

Ref	M				
1400 8106	PZ-0	3/8"	1	4,00	✓
1400 8107	PZ-1	3/8"	1	4,00	✓
1400 8108	PZ-2	3/8"	1	4,00	✓
1400 8109	PZ-3	3/8"	1	4,00	✓

## HEXAGONAL



1/4"

Ref	M				
1400 8080	H-1,5	1/4"	1	3,32	✓
1400 8081	H-2	1/4"	1	3,32	✓
1400 8082	H-2,5	1/4"	1	3,32	✓
1400 8083	H-3	1/4"	1	3,32	✓
1400 8084	H-4	1/4"	1	3,32	✓
1400 8085	H-5	1/4"	1	3,32	✓
1400 8086	H-6	1/4"	1	3,32	✓
1400 8087	H-7	1/4"	1	3,61	✓
1400 8088	H-8	1/4"	1	3,61	✓

3/8"

Ref	M				
1400 8124	H-3	3/8"	1	4,00	✓
1400 8125	H-4	3/8"	1	4,00	✓
1400 8126	H-5	3/8"	1	4,00	✓
1400 8127	H-6	3/8"	1	4,00	✓
1400 8128	H-7	3/8"	1	4,00	✓
1400 8129	H-8	3/8"	1	4,00	✓
1400 8130	H-10	3/8"	1	4,00	✓
1400 8131	H-12	3/8"	1	4,00	✓

## TORX



1/4"

Ref	M				
1400 8069	T-6	1/4"	1	3,32	✓
1400 8070	T-7	1/4"	1	3,32	✓
1400 8071	T-8	1/4"	1	3,32	✓
1400 8072	T-9	1/4"	1	3,32	✓
1400 8073	T-10	1/4"	1	3,32	✓
1400 8074	T-15	1/4"	1	3,32	✓
1400 8075	T-20	1/4"	1	3,32	✓
1400 8076	T-25	1/4"	1	3,32	✓
1400 8077	T-27	1/4"	1	3,32	✓
1400 8078	T-30	1/4"	1	3,32	✓
1400 8079	T-40	1/4"	1	3,32	✓

3/8"

Ref	M				
1400 8110	T-8	3/8"	1	4,00	✓
1400 8111	T-9	3/8"	1	4,00	✓
1400 8112	T-10	3/8"	1	4,00	✓
1400 8113	T-15	3/8"	1	4,00	✓
1400 8114	T-20	3/8"	1	4,00	✓
1400 8115	T-25	3/8"	1	4,00	✓
1400 8116	T-27	3/8"	1	4,00	✓
1400 8117	T-30	3/8"	1	4,00	✓
1400 8118	T-40	3/8"	1	4,00	✓
1400 8119	T-45	3/8"	1	4,00	✓
1400 8120	T-47	3/8"	1	4,00	✓
1400 8121	T-50	3/8"	1	4,00	✓
1400 8122	T-55	3/8"	1	4,00	✓
1400 8123	T-60	3/8"	1	4,00	✓



PLANO



1/4"

Ref	M				
1400 8089	SL-4	1/4"	1	3,32	✓
1400 8090	SL-5,5	1/4"	1	3,32	✓
1400 8091	SL-6,5	1/4"	1	3,32	✓
1400 8092	SL-7	1/4"	1	3,32	✓

3/8"

Ref	M				
1400 8132	SL-4	3/8"	1	4,00	✓
1400 8133	SL-5,5	3/8"	1	4,00	✓
1400 8134	SL-6,5	3/8"	1	4,00	✓
1400 8135	SL-7	3/8"	1	4,00	✓
1400 8136	SL-8	3/8"	1	4,00	✓
1400 8137	SL-10	3/8"	1	4,00	✓
1400 8138	SL-12	3/8"	1	4,00	✓

PHILLIPS



1/2"

Ref	M				
1400 8139	PH-2	1/2"	1	5,15	✓
1400 8140	PH-3	1/2"	1	5,15	✓

POZIDRIVE



1/2"

Ref	M				
1400 8141	PZ-2	1/2"	1	5,15	✓
1400 8142	PZ-3	1/2"	1	5,15	✓

TORX



1/2"

Ref	M				
1400 8143	T-20	1/2"	1	5,15	✓
1400 8144	T-25	1/2"	1	5,15	✓
1400 8145	T-27	1/2"	1	5,15	✓
1400 8146	T-30	1/2"	1	5,15	✓
1400 8147	T-40	1/2"	1	5,15	✓
1400 8148	T-45	1/2"	1	5,15	✓
1400 8149	T-50	1/2"	1	5,15	✓
1400 8150	T-55	1/2"	1	5,15	✓



## HEXAGONAL



1/2"



Ref	M				
1400 8151	H-4	1/2"	1	5,15	✓
1400 8152	H-5	1/2"	1	5,15	✓
1400 8153	H-6	1/2"	1	5,15	✓
1400 8154	H-7	1/2"	1	5,15	✓
1400 8155	H-8	1/2"	1	5,15	✓
1400 8156	H-10	1/2"	1	5,15	✓

## SLOTTED



1/2"



Ref	M				
1400 8157	SL-8	1/2"	1	5,15	✓
1400 8158	SL-10	1/2"	1	5,15	✓

## XZN



1/2"



Ref	M				
1400 8159	XZN-5	1/2"	1	5,15	✓
1400 8160	XZN-6	1/2"	1	5,15	✓
1400 8161	XZN-8	1/2"	1	5,15	✓
1400 8162	XZN-10	1/2"	1	5,15	✓

## PHILLIPS - EXTRA LARGA 65 mm / EXTRA LONGUE / EXTRA LONG / EXTRA LUNGA / EXTRA LONGA



1/2"

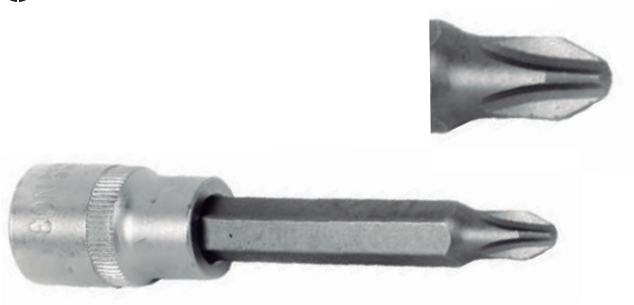

Ref	M				
1400 8163	PH-2	1/2"	1	5,67	✓
1400 8164	PH-3	1/2"	1	5,67	✓



POZIDRIVE - EXTRA LARGA 65 mm / EXTRA LONGUE / EXTRA LONG / EXTRA LUNGA / EXTRA LONGA



1/2"

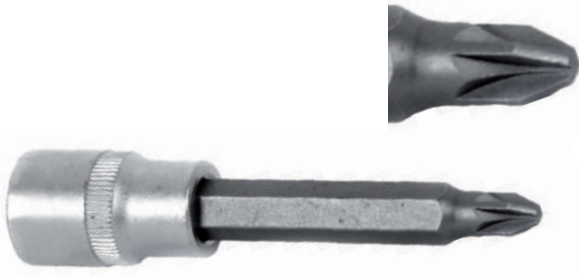

Ref	M				
1400 8165	PZ-2	1/2"	1	5,67	✓
1400 8166	PZ-3	1/2"	1	5,67	✓

TORX - EXTRA LARGA 65 mm / EXTRA LONGUE / EXTRA LONG / EXTRA LUNGA / EXTRA LONGA



1/2"

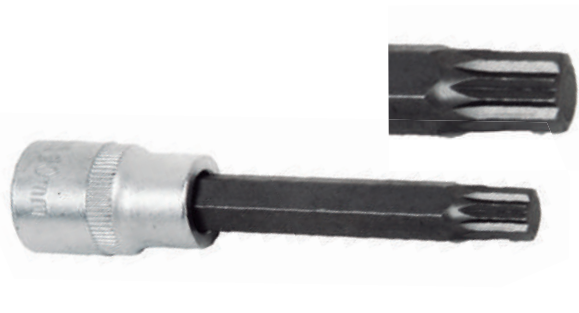

Ref	M				
1400 8167	T-20	1/2"	1	5,67	✓
1400 8168	T-25	1/2"	1	5,67	✓
1400 8169	T-27	1/2"	1	5,67	✓
1400 8170	T-30	1/2"	1	5,67	✓
1400 8171	T-40	1/2"	1	5,67	✓
1400 8172	T-45	1/2"	1	5,67	✓
1400 8173	T-50	1/2"	1	5,67	✓
1400 8174	T-55	1/2"	1	5,67	✓

ALLEN - EXTRA LARGA 65 mm / EXTRA LONGUE / EXTRA LONG / EXTRA LUNGA / EXTRA LONGA



1/2"

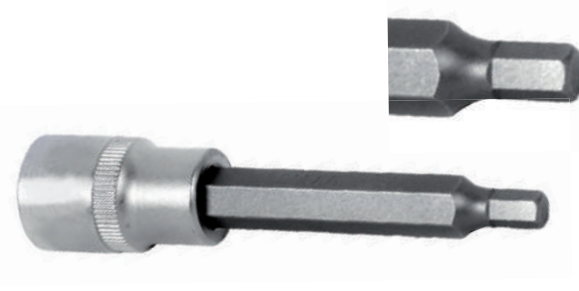

Ref	M				
1400 8175	H-4	1/2"	1	5,67	✓
1400 8176	H-5	1/2"	1	5,67	✓
1400 8177	H-6	1/2"	1	5,67	✓
1400 8178	H-7	1/2"	1	5,67	✓
1400 8179	H-8	1/2"	1	5,67	✓
1400 8180	H-10	1/2"	1	5,67	✓

PLANA - EXTRA LARGA 65 mm / PLATE - EXTRA LONGUE / SLOTTED - EXTRA LONG / PIATTA - EXTRA LUNGA / PLANA - EXTRA LONGA



1/2"

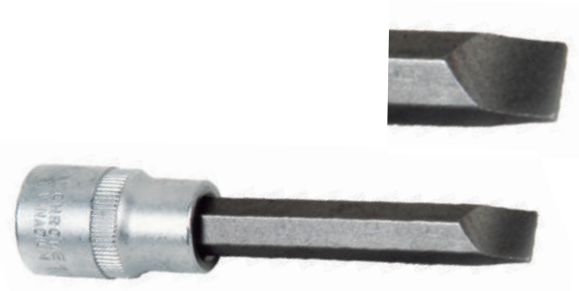

Ref	M				
1400 8181	SL-8	1/2"	1	5,67	✓
1400 8182	SL-10	1/2"	1	5,67	✓

XZN - EXTRA LARGA 65 mm / EXTRA LONGUE / EXTRA LONG / EXTRA LUNGA / EXTRA LONGA



1/2"

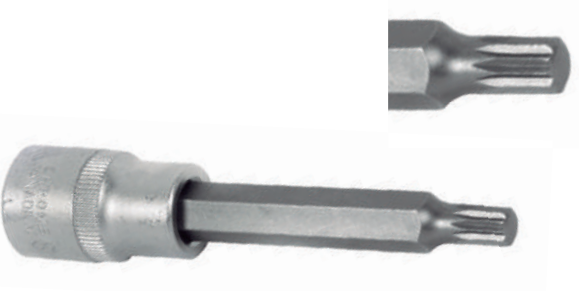

Ref	M				
1400 8183	XZN-5	1/2"	1	5,67	✓
1400 8184	XZN-6	1/2"	1	5,67	✓
1400 8185	XZN-8	1/2"	1	5,67	✓
1400 8186	XZN-10	1/2"	1	5,67	✓



LLAVE FIJA REFORZADA UNA BOCA / CLE FIXE RENFORCEE UNE FOURCHE / SINGLE OPEN-END JAW SPANNER  
CHIAVI FISSE RINFORZATE, AD UNA BOCCA / CHAVE FIXA REFORÇADA UMA BOCA



Ref	M			
0951 2176	8	1	10	4,42
0951 2177	9	1	10	4,46
0951 2178	10	1	10	4,64
0951 2179	11	1	10	4,82
0951 2180	12	1	10	4,94
0951 2181	13	1	10	5,34
0951 2182	14	1	10	5,21
0951 2183	15	1	10	5,70
0951 2184	16	1	10	5,50
0951 2185	17	1	10	5,85
0951 2186	18	1	10	7,22
0951 2187	19	1	10	7,39
0951 2188	21	1	10	8,37
0951 2189	22	1	10	8,68
0951 2190	24	1	5	11,72
0951 2191	27	1	5	13,64
0951 2192	30	1	5	16,98
0951 2193	32	1	5	17,54
0951 2194	34	1	5	23,08
0951 2195	36	1	5	24,56
0951 2196	38	1	5	28,53
0951 2197	41	1	5	31,05
0951 2198	46	1	1	38,10
0951 2199	50	1	1	49,86
0951 2200	55	1	1	57,62
0951 2201	60	1	1	67,73
0951 2202	65	1	1	88,50

LLAVE FIJA REFORZADA DOBLE BOCA / CLE FIXE RENFORCEE 2 FOURCHES / DOUBLE OPEN-END WRENCH  
CHIAVI FISSE RINFORZATE, A DUE BOCCHE / CHAVE FIXA REFORÇADA DUPLA BOCA



Ref	M				Ref	M			
0951 2109	6 - 7	1	10	3,84	0951 2131	17 - 22	1	5	9,32
0951 2110	7 - 8	1	10	3,97	0951 2132	19 - 22	1	5	8,84
0951 2111	8 - 9	1	10	3,73	0951 2133	20 - 22	1	5	8,98
0951 2112	8 - 10	1	10	4,12	0951 2134	19 - 24	1	5	9,82
0951 2113	9 - 11	1	10	3,72	0951 2135	21 - 23	1	5	11,00
0951 2114	10 - 11	1	10	4,48	0951 2136	21 - 24	1	5	11,00
0951 2115	10 - 12	1	10	4,88	0951 2137	22 - 24	1	5	10,45
0951 2116	10 - 13	1	10	4,94	0951 2138	22 - 27	1	5	11,51
0951 2117	11 - 13	1	10	4,86	0951 2139	24 - 27	1	5	14,49
0951 2118	12 - 13	1	10	5,29	0951 2140	25 - 28	1	5	14,83
0951 2119	12 - 14	1	10	4,44	0951 2141	24 - 30	1	5	15,77
0951 2120	13 - 14	1	10	4,77	0951 2142	27 - 30	1	5	18,23
0951 2121	13 - 15	1	10	5,34	0951 2143	27 - 32	1	5	19,39
0951 2122	13 - 16	1	10	5,07	0951 2144	30 - 32	1	5	19,39
0951 2123	14 - 15	1	5	5,91	0951 2145	30 - 34	1	5	23,96
0951 2124	13 - 17	1	5	5,91	0951 2146	30 - 36	1	5	23,96
0951 2125	14 - 17	1	5	5,65	0951 2147	32 - 36	1	5	23,96
0951 2126	16 - 17	1	5	6,83	0951 2148	34 - 36	1	1	31,33
0951 2127	16 - 18	1	5	6,43	0951 2149	36 - 41	1	1	36,62
0951 2128	17 - 19	1	5	6,83	0951 2150	41 - 46	1	1	42,97
0951 2129	18 - 19	1	5	8,75	0951 2151	46 - 50	1	1	59,11
0951 2130	18 - 21	1	5	8,98	0951 2152	50 - 55	1	1	68,61





LLAVE DE IMPACTO ESTRELLA / POLIGONALE À FRAPPER / SLOGGING RING SPANNER / A STELLA A PERCUSSIONE / CHAVES DE IMPACTO LUNETETA



Ref	M		
0951 2203	24	1	30,30
0951 2204	27	1	35,07
0951 2205	30	1	40,57
0951 2206	32	1	39,44
0951 2207	36	1	49,39
0951 2208	41	1	61,87
0951 2209	42	1	64,92
0951 2210	46	1	66,24
0951 2211	50	1	80,37
0951 2212	55	1	93,04
0951 2213	60	1	109,29
0951 2214	65	1	136,28
0951 2215	70	1	162,62
0951 2216	75	1	176,02
0951 2217	80	1	221,42
0951 2218	85	1	267,91
0951 2219	90	1	324,16
0951 2220	95	1	385,11
0951 2221	100	1	432,70
0951 2222	105	1	467,33
0951 2223	110	1	514,06
0951 2224	115	1	565,46
0951 2225	120	1	638,97

LLAVE DE IMPACTO FIJA UNA BOCA / A FOURCHE A FRAPPER / SLOGGING OPEN-END SPANNER  
 FISSA A PERCUSSIONE / CHAVES DE IMPACTO FIXA UMA BOCA



Ref	M		
0951 2153	24	1	32,43
0951 2154	27	1	35,60
0951 2155	30	1	35,06
0951 2156	32	1	36,30
0951 2157	36	1	37,92
0951 2158	41	1	62,44
0951 2159	46	1	73,67
0951 2160	50	1	81,03
0951 2161	55	1	100,86
0951 2162	60	1	116,99
0951 2164	65	1	146,23
0951 2165	70	1	182,79
0951 2166	75	1	201,08
0951 2167	80	1	224,91
0951 2168	85	1	390,17
0951 2169	90	1	321,60
0951 2170	95	1	367,22
0951 2171	100	1	532,53
0951 2172	105	1	682,32
0951 2173	110	1	716,43
0951 2174	115	1	931,35
0951 2175	120	1	1.009,35



¼" TORX - VASO DE IMPACTO HEMBRA / DOUILLES A CHOC FEMELLE / IMPACT SOCKETS FEMALE  
BUSSOLE A PERCUSSIONE FEMMINA / SOQUETES DE IMPACTO FÈMEA



1/4"



Ref	M			
0976 5301	E-4	1	3,72	✓
0976 5302	E-5	1	3,72	✓
0976 5303	E-6	1	3,72	✓
0976 5304	E-7	1	3,72	✓
0976 5305	E-8	1	3,72	✓
0976 5306	E-10	1	4,35	✓
0976 5307	E-11	1	4,35	✓
0976 5308	E-12	1	4,35	✓

¼" TORX - VASO DE IMPACTO MACHO / DOUILLES A CHOC MALE / IMPACT SOCKETS MALE  
BUSSOLE A PERCUSSIONE MASCHIO / SOQUETES DE IMPACTO MACHO



1/4"



Ref	M				Ref	M			
0976 5401	T-5	1	6,75	✓	0976 5407	T-15	1	6,75	✓
0976 5402	T-6	1	6,75	✓	0976 5408	T-20	1	6,75	✓
0976 5403	T-7	1	6,75	✓	0976 5409	T-25	1	6,75	✓
0976 5404	T-8	1	6,75	✓	0976 5410	T-27	1	6,75	✓
0976 5405	T-9	1	6,75	✓	0976 5411	T-30	1	6,75	✓
0976 5406	T-10	1	6,75	✓					

ALARGADERA DE IMPACTO ¼" / RALLONGE / EXTENSION / PROLUNGA / EXTENSÃO

1/4"



Ref				
0900 0001	¼"	50 mm	1	17,32

ARTICULACIÓN UNIVERSAL DE IMPACTO ¼" / CARDAN UNIVERSAL / UNIVERSAL JOINT / SNODO UNIVERSALE / ARTICULAÇÃO UNIVERSAL

1/4"



Ref				
0900 0014	¼"	¼"	1	36,12

ADAPTADOR DE IMPACTO ¼" / ADAPTATEUR / ADAPTER / ADATTATORE / ADAPTADOR

1/4" - 3/8"

3/8" - 1/4"



Ref	H	M		
0900 0019	¼"	3/8"	1	17,35
0900 0020	3/8"	¼"	1	17,35



**BOCAS DE IMPACTO / DOUILLES A CHOC / IMPACT SOCKETS  
BUSSOLE A PERCUSSIONE / SOQUETES DE IMPACTO**

**Cr/V**

3/8" TORX - VASO DE IMPACTO HEMBRA / DOUILLES À CHOC FEMELLE / IMPACT SOCKETS FEMALE  
BUSSOLE A PERCUSSIONE FEMMINA / SOQUETES DE IMPACTO FÈMEA



3/8"



Ref	M			
0976 5320	E-5	1	4,46	✓
0976 5321	E-6	1	4,46	✓
0976 5322	E-7	1	4,46	✓
0976 5323	E-8	1	4,46	✓
0976 5324	E-10	1	4,46	✓
0976 5325	E-11	1	4,46	✓
0976 5326	E-12	1	4,46	✓
0976 5327	E-14	1	4,46	✓
0976 5328	E-16	1	4,46	✓

3/8" TORX - VASO DE IMPACTO MACHO / DOUILLES À CHOC MALE / IMPACT SOCKETS MALE  
BUSSOLE A PERCUSSIONE MASCHIO / SOQUETES DE IMPACTO MACHO



3/8"



Ref	M				Ref	M			
0976 5420	T-9	1	9,38	✓	0976 5426	T-30	1	9,38	✓
0976 5421	T-10	1	9,38	✓	0976 5427	T-40	1	9,38	✓
0976 5422	T-15	1	9,38	✓	0976 5428	T-45	1	9,38	✓
0976 5423	T-20	1	9,38	✓	0976 5429	T-47	1	9,38	✓
0976 5424	T-25	1	9,38	✓	0976 5430	T-50	1	9,38	✓
0976 5425	T-27	1	9,38	✓					

3/8" HEXAGONAL - VASO DE IMPACTO MACHO / DOUILLES À CHOC MALE / IMPACT SOCKETS MALE  
BUSSOLE A PERCUSSIONE MASCHIO / SOQUETES DE IMPACTO MACHO



3/8"



Ref	M				Ref	M			
0976 5500	3 mm	1	9,38	✓	0976 5507	10 mm	1	9,38	✓
0976 5501	4 mm	1	9,38	✓	0976 5508	11 mm	1	9,38	✓
0976 5502	5 mm	1	9,38	✓	0976 5509	12 mm	1	9,38	✓
0976 5503	6 mm	1	9,38	✓	0976 5510	13 mm	1	9,38	✓
0976 5504	7 mm	1	9,38	✓	0976 5511	14 mm	1	9,38	✓
0976 5505	8 mm	1	9,38	✓	0976 5512	15 mm	1	9,38	✓
0976 5506	9 mm	1	9,38	✓	0976 5513	16 mm	1	9,38	✓

PROLONGADOR DE IMPACTO 3/8" / RALLONGE À CHOC / IMPACT EXTENSION / PROLUNGA A PERCUSSIONE / EXTENSÃO DE IMPACTO

3/8"



Ref				
0900 0002	3/8"	75 mm	1	18,77
0900 0003	3/8"	125 mm	1	20,22
0900 0004	3/8"	250 mm	1	33,22

ARTICULACIÓN UNIVERSAL DE IMPACTO 3/8" / CARDAN UNIVERSAL / UNIVERSAL JOINT  
SNODO UNIVERSALE / ARTICULAÇÃO UNIVERSAL DE IMPACTO

3/8"



Ref				
0900 0015	3/8"	3/8"	1	36,13



ADAPTADOR DE IMPACTO 3/8" / ADAPTATEUR / ADAPTER / ADATTATORE / ADAPTADOR

3/8" - 1/2"

1/2" - 3/8"



Ref	H	M		
0900 0021	3/8"	1/2"	1	17,35
0900 0022	1/2"	3/8"	1	16,69

1/2" TORX - VASO DE IMPACTO HEMBRA / DOUILLES A CHOC FEMELLE / IMPACT SOCKETS FEMALE  
BUSSOLE A PERCUSSIONE FEMMINA / SOQUETES DE IMPACTO FÊMEA

1/2"



Ref	M			
0976 5340	E-10	1	5,38	✓
0976 5341	E-11	1	5,38	✓
0976 5342	E-12	1	5,38	✓
0976 5343	E-14	1	5,38	✓
0976 5344	E-16	1	5,38	✓
0976 5345	E-18	1	5,38	✓
0976 5346	E-20	1	7,21	✓
0976 5347	E-22	1	7,21	✓
0976 5348	E-24	1	7,21	✓

1/2" TORX - VASO DE IMPACTO MACHO / DOUILLES A CHOC MALE / IMPACT SOCKETS MALE  
BUSSOLE A PERCUSSIONE MASCHIO / SOQUETES DE IMPACTO MACHO

1/2"



Ref	M				Ref	M			
0976 5440	T-20	1	11,29	✓	0976 5446	T-47	1	11,29	✓
0976 5441	T-25	1	11,29	✓	0976 5447	T-50	1	11,29	✓
0976 5442	T-27	1	11,29	✓	0976 5448	T-55	1	11,29	✓
0976 5443	T-30	1	11,29	✓	0976 5449	T-60	1	11,29	✓
0976 5444	T-40	1	11,29	✓	0976 5450	T-70	1	11,29	✓
0976 5445	T-45	1	11,29	✓					

1/2" HEXAGONAL - VASO DE IMPACTO MACHO / DOUILLES A CHOC MALE / IMPACT SOCKETS MALE  
BUSSOLE A PERCUSSIONE MASCHIO / SOQUETES DE IMPACTO MACHO

1/2"



Ref	M			
0976 5520	4 mm	1	11,29	✓
0976 5521	5 mm	1	11,29	✓
0976 5522	6 mm	1	11,29	✓
0976 5523	7 mm	1	11,29	✓
0976 5524	8 mm	1	11,29	✓
0976 5525	9 mm	1	11,29	✓
0976 5526	10 mm	1	11,29	✓
0976 5527	11 mm	1	11,29	✓
0976 5528	12 mm	1	11,29	✓
0976 5529	13 mm	1	11,29	✓
0976 5530	14 mm	1	11,29	✓
0976 5531	15 mm	1	11,29	✓
0976 5532	16 mm	1	12,66	✓
0976 5533	17 mm	1	12,66	✓
0976 5534	18 mm	1	13,38	✓
0976 5535	19 mm	1	13,38	✓



SERIE NORMAL 1/2" DE IMPACTO / SERIE NORMAL À CHOC / STANDARD SERIES / SERIE NORMALE / SERIE NORMAL

○  
1/2"



Ref	M			
0976 5008	8 mm	1	9,72	✓
0976 5009	9 mm	1	9,72	✓
0976 5010	10 mm	1	9,72	✓
0976 5011	11 mm	1	9,72	✓
0976 5012	12 mm	1	9,72	✓
0976 5013	13 mm	1	10,35	✓
0976 5014	14 mm	1	10,35	✓
0976 5015	15 mm	1	10,35	✓
0976 5016	16 mm	1	10,35	✓
0976 5017	17 mm	1	10,35	✓
0976 5018	18 mm	1	10,35	✓
0976 5019	19 mm	1	11,12	✓
0976 5021	21 mm	1	11,38	✓
0976 5022	22 mm	1	11,38	✓
0976 5023	23 mm	1	12,50	✓
0976 5024	24 mm	1	12,50	✓
0976 5026	26 mm	1	12,50	✓
0976 5027	27 mm	1	15,27	✓
0976 5028	28 mm	1	18,04	✓
0976 5029	29 mm	1	18,04	✓
0976 5030	30 mm	1	19,43	✓
0976 5032	32 mm	1	19,43	✓

JUEGO VASOS DE IMPACTO 1/2" / KIT DOUILLES A CHOC 1/2" / 1/2" IMPACT SOCKET WRENCHES SET  
KIT BUSSOLE PER CHIAVE A PERCUSSIONE 1/2" / JOGO DE SOQUETES DE IMPACTO 1/2"

1/2"



Ref	M		
0976 5001	10 - 11 - 12 - 13 - 14 - 17 - 19 - 21 - 22 - 24	1	61,57

VASO DE IMPACTO SERIE LARGA 1/2" / SERIE LONGUE / LONG SERIES / SERIE LUNGA / SERIE LONGA

○  
1/2"



Ref	M			
0976 5010L	10 mm	1	16,65	✓
0976 5011L	11 mm	1	16,65	✓
0976 5012L	12 mm	1	16,65	✓
0976 5013L	13 mm	1	16,65	✓
0976 5014L	14 mm	1	16,65	✓
0976 5015L	15 mm	1	16,65	✓
0976 5016L	16 mm	1	16,65	✓
0976 5017L	17 mm	1	16,65	✓
0976 5018L	18 mm	1	18,48	✓
0976 5019L	19 mm	1	18,48	✓
0976 5021L	21 mm	1	19,71	✓
0976 5022L	22 mm	1	19,71	✓
0976 5023L	23 mm	1	22,29	✓
0976 5024L	24 mm	1	22,29	✓
0976 5026L	26 mm	1	23,60	✓
0976 5027L	27 mm	1	26,38	✓





ALARGADERA 1/2" / RALLONGE / EXTENSION / PROLUNGA / EXTENSÃO

1/2"



Ref		$\longleftrightarrow$		
0900 0005	1/2"	75 mm	1	20,22
0900 0006	1/2"	125 mm	1	21,68
0900 0007	1/2"	250 mm	1	37,55

ARTICULACIÓN UNIVERSAL 1/2" / CARDAN UNIVERSEL / UNIVERSAL JOINT / SNODO UNIVERSALE / ARTICULAÇÃO UNIVERSAL

1/2"



Ref		$\longleftrightarrow$		
0900 0016	1/2"	1/2"	1	36,11

ADAPTADOR 1/2" / ADAPTATEUR / ADAPTER / ADATTATORE / ADAPTADOR

1/2" - 3/4"

3/4" - 1/2"



Ref	H	M		
0900 0023	1/2"	3/4"	1	18,77
0900 0024	3/4"	1/2"	1	33,22

VASO DE IMPACTO 3/4" - SERIE NORMAL / SERIE NORMAL / STANDARD SERIES / SERIE NORMALE / SERIE NORMAL



3/4"



Ref	M		
0976 5117	17 mm	1	23,12
0976 5118	18 mm	1	23,12
0976 5119	19 mm	1	23,12
0976 5121	21 mm	1	23,12
0976 5122	22 mm	1	23,12
0976 5123	23 mm	1	23,12
0976 5124	24 mm	1	23,12
0976 5126	26 mm	1	23,12
0976 5127	27 mm	1	23,12
0976 5128	28 mm	1	25,99
0976 5129	29 mm	1	25,99
0976 5130	30 mm	1	25,99
0976 5132	32 mm	1	27,43
0976 5133	33 mm	1	28,87
0976 5135	35 mm	1	28,87
0976 5136	36 mm	1	30,32
0976 5138	38 mm	1	34,64
0976 5141	41 mm	1	40,44
0976 5142	42 mm	1	43,32
0976 5146	46 mm	1	50,54
0976 5150	50 mm	1	76,52



**BOCAS DE IMPACTO / DOUILLES A CHOC / IMPACT SOCKETS  
BUSSOLE A PERCUSSIONE / SOQUETES DE IMPACTO**

**Cr/V**

VASO DE IMPACTO 3/4" - SERIE LARGA / SERIE LONGUE / LONG SERIES / SERIE LUNGA / SERIE LONGA



Ref	M			Ref	M		
0976 5119L	19 mm	1	41,84	0976 5129L	29 mm	1	43,32
0976 5121L	21 mm	1	41,84	0976 5130L	30 mm	1	43,32
0976 5122L	22 mm	1	41,84	0976 5132L	32 mm	1	43,32
0976 5123L	23 mm	1	41,84	0976 5133L	33 mm	1	46,20
0976 5124L	24 mm	1	41,84	0976 5135L	35 mm	1	47,63
0976 5126L	26 mm	1	43,32	0976 5136L	36 mm	1	53,44
0976 5127L	27 mm	1	43,32	0976 5138L	38 mm	1	56,84
0976 5128L	28 mm	1	43,32	0976 5141L	41 mm	1	66,44

VASO DE IMPACTO MACHO 3/4" HEXAGONAL / DOUILLES MALE / SOCKETS MALE / BUSSOLE MASCHIO / SOQUETES



Ref	M			
0976 5540	10 mm	1	35,56	✓
0976 5541	12 mm	1	35,56	✓
0976 5542	14 mm	1	35,56	✓
0976 5543	17 mm	1	35,56	✓
0976 5544	19 mm	1	35,56	✓
0976 5545	22 mm	1	35,56	✓
0976 5546	24 mm	1	35,56	✓
0976 5547	27 mm	1	35,56	✓

ALARGADERA DE IMPACTO 3/4" / RALLONGE À CHOC / IMPACT EXTENSION / PROLUNGA A PERCUSSIONE / EXTENSÃO DE IMPACTO



Ref					
0900 0008	3/4"	100 mm	1	41,88	✓
0900 0009	3/4"	175 mm	1	50,55	✓
0900 0010	3/4"	250 mm	1	59,21	✓

ARTICULACIÓN UNIVERSAL 3/4" / CARDAN UNIVERSEL À CHOC / IMPACT UNIVERSAL JOINT  
SNODO UNIVERSALE A PERCUSSIONE / ARTICULAÇÃO UNIVERSAL DE IMPACTO



Ref				
0900 0017	3/4"	3/4"	1	86,67

ADAPTADOR DE IMPACTO 3/4" / ADAPTATEUR À CHOC / IMPACT ADAPTER / ADATTATORE A PERCUSSIONE / ADAPTADOR DE IMPACTO



Ref	H	M		
0900 0025	3/4"	1"	1	40,46

VASOS DE IMPACTO 1" HEXAGONAL / DOUILLES A CHOC HEX / IMPACT SOCKETS HEX  
BUSSOLE A PERCUSSIONE ESAGONALE / SOQUETES DE IMPACTO SEXTAVADO○  
1"

Ref	M			
0976 5560	10 mm	1	41,07	✓
0976 5561	12 mm	1	41,07	✓
0976 5562	14 mm	1	41,07	✓
0976 5563	17 mm	1	41,07	✓
0976 5564	19 mm	1	41,07	✓
0976 5565	22 mm	1	41,07	✓

VASO DE IMPACTO 1" - SERIE NORMAL / SERIE NORMAL À CHOC / STANDARD SERIES / SERIE NORMALE / SERIE NORMAL DE IMPACTO

○



Ref	M			Ref	M		
0976 5221	21 mm	1	41,88	0976 5242	42 mm	1	57,75
0976 5222	22 mm	1	41,88	0976 5246	46 mm	1	64,99
0976 5223	23 mm	1	41,88	0976 5250	50 mm	1	72,20
0976 5224	24 mm	1	41,88	0976 5252	52 mm	1	77,97
0976 5226	26 mm	1	41,88	0976 5254	54 mm	1	85,20
0976 5227	27 mm	1	41,88	0976 5255	55 mm	1	93,87
0976 5228	28 mm	1	43,32	0976 5258	58 mm	1	103,96
0976 5229	29 mm	1	43,32	0976 5260	60 mm	1	109,74
0976 5230	30 mm	1	43,32	0976 5265	65 mm	1	116,95
0976 5232	32 mm	1	43,32	0976 5270	70 mm	1	158,82
0976 5233	33 mm	1	44,75	0976 5275	75 mm	1	199,62
0976 5235	35 mm	1	46,40	0976 5280	80 mm	1	213,69
0976 5236	36 mm	1	46,40	0976 5285	85 mm	1	235,40
0976 5238	38 mm	1	56,31	0976 5290	90 mm	1	310,25
0976 5241	41 mm	1	56,31				

VASO DE IMPACTO 1" - SERIE LARGA / SERIE LONGUE / LONG SERIES / SERIE LUNGA / SERIE LONGA

○  
1"

Ref	M		
0976 5221L	21 mm	1	59,21
0976 5222L	22 mm	1	59,21
0976 5223L	23 mm	1	59,21
0976 5224L	24 mm	1	59,21
0976 5226L	26 mm	1	59,21
0976 5227L	27 mm	1	59,21
0976 5228L	28 mm	1	59,21
0976 5229L	29 mm	1	59,21
0976 5230L	30 mm	1	63,51
0976 5232L	32 mm	1	63,51
0976 5233L	33 mm	1	64,99
0976 5235L	35 mm	1	64,99
0976 5236L	36 mm	1	64,99
0976 5238L	38 mm	1	67,87
0976 5241L	41 mm	1	69,21
0976 5242L	42 mm	1	72,20
0976 5246L	46 mm	1	79,42
0976 5250L	50 mm	1	90,96
0976 5252L	52 mm	1	106,84
0976 5254L	54 mm	1	115,51
0976 5255L	55 mm	1	115,51
0976 5258L	58 mm	1	129,95
0976 5260L	60 mm	1	158,84



ARTICULACIÓN UNIVERSAL 1" / CARDAN UNIVERSEL / UNIVERSAL JOINT / SNODO UNIVERSALE / ARTICULAÇÃO UNIVERSAL

○  
1"



Ref					
0900 0018	1"	1"	1	129,95	✓

ADAPTADOR DE IMPACTO 1" / ADAPTATEUR / ADAPTER / ADATTATORE / ADAPTADOR DE IMPACTO

1" - 3/4"



Ref	H	M			
0900 0026	1"	3/4"	1	53,44	✓

ALARGADERA DE IMPACTO 1" / RALLONGE / EXTENSION / PROLUNGA / EXTENSÃO

1"



Ref					
0900 0011	1"	175 mm	1	92,40	✓
0900 0012	1"	250 mm	1	101,08	✓
0900 0013	1"	330 mm	1	114,07	✓

KIT MULTIPLICADOR DE PAR / KIT DEMULTIPLICATEUR DE FORCE POUR BOULONS A ROUES / TORQUE REPLICATOR KIT  
KIT MOLTIPLICATORE DI GIRI / KIT CHAVE DE RODAS



Ref	OUT N.M.	RATIO					
0951 8015	3500 Nm	1:56	1"	210 mm	8,8 kg	1	192,25



JUEGOS LLAVES HEXAGONALES / SET HEXAGONAL KEY WRENCHES



Ref					
0950 8535	8 - ALLEN	2-2,5-3-4-5-6-8-10	1	19,70	✓



Ref					
0950 8536	6 - ALLEN	2,5-3-4-5-6-8	1	16,80	✓



Ref					
0950 8538	8-stand.	1, 5-2-2, 5-3-4-5-5, 5-6	1	7,80	✓
0950 8539	10-stand.	1, 5-2-2,5-3-4-5-5, 5-6-8-10	1	15,50	✓

LLAVES HEXAGONALES / CLÉS MALES / HEXAGONAL KEY WRENCHES / CHIAVI ESAGONALI / CHAVE SEXTAVADA



STANDARD



Ref				
0950 8601	0,9 mm	1	10	0,62
0950 8602	1,5 mm	1	10	0,62
0950 8603	2 mm	1	10	0,79
0950 8604	2,5 mm	1	10	0,68
0950 8605	3 mm	1	10	0,68
0950 8606	3,5 mm	1	10	0,73
0950 8607	4 mm	1	10	0,73
0950 8608	4,5 mm	1	10	0,78
0950 8609	5 mm	1	10	0,83
0950 8610	5,5 mm	1	10	0,94
0950 8611	6 mm	1	10	1,25
0950 8612	8 mm	1	5	1,56
0950 8613	9 mm	1	5	1,66
0950 8614	10 mm	1	5	2,18
0950 8615	11 mm	1	5	3,02
0950 8616	12 mm	1	1	4,22
0950 8617	13 mm	1	1	5,04
0950 8618	14 mm	1	1	5,41
0950 8619	15 mm	1	1	7,18
0950 8620	16 mm	1	1	7,96
0950 8621	17 mm	1	1	9,62
0950 8622	19 mm	1	1	13,36
0950 8623	21 mm	1	1	17,47
0950 8624	22 mm	1	1	17,47
0950 8625	24 mm	1	1	25,01





**LLAVES ALLEN Y TORX / CLÉ ALLEN ET TORX / ALLEN & TORX WRENCHES  
CHIAVI ALLEN E TORX / CHAVES ALLEN E TORX**

MALETÍN SURTIDO DE LLAVES ALLEN / VALISSETTE ASSORTIMENT DE CLES ALLEN / BOX OF ALLEN KEY WRENCHES  
VALIGETTA ASSORTITA DI CHIAVI ALLEN / CAIXA SORTIDA DE CHAVES ALLEN



Ref				
0950 8699	0,9 - 10 mm	140 uds	1	160,40

Ref		
0940 0226	46x32x8 cm	1
0950 8601	M-0,90	10
0950 8602	M-1,5	10
0950 8603	M-2	10
0950 8604	M-2,5	10
0950 8605	M-3	10
0950 8606	M-3,5	10
0950 8607	M-4	10
0950 8608	M-4,5	10
0950 8609	M-5	10
0950 8610	M-5,5	10
0950 8611	M-6	10
0950 8612	M-8	10
0950 8613	M-9	10
0950 8614	M-10	10

LLAVES HEXAGONALES SERIE LARGA / CLÉS MALES SERIE LONGUE / HEXAGONAL KEY WRENCHES LONG  
CHIAVE ESAGONALE SERIE LUNGA / CHAVE SEXTAVADA SÉRIE LONGA



**LONG**



Ref				
0950 8515	1,5 mm	1	5	0,74
0950 8516	2 mm	1	5	0,78
0950 8517	2,5 mm	1	5	0,97
0950 8518	3 mm	1	5	1,25
0950 8519	4 mm	1	5	1,30
0950 8520	5 mm	1	5	1,35
0950 8521	5,5 mm	1	5	1,46
0950 8522	6 mm	1	5	1,56
0950 8523	8 mm	1	5	2,91
0950 8524	10 mm	1	5	3,95

JUEGOS LLAVES HEXAGONALES / JEUX CLES MALES / SET HEXAGONAL KEY WRENCHES / KIT CHIAVI ESAGONALI / JOGO DE CHAVES SEXTAVADAS



**LONG**



Ref					
0950 8540	7-long	2,5-3-4-5-6-8-10	1	14,00	✓



LLAVES HEXAGONALES SERIE LARGA / CLÉS MALES SERIE LONGUE / HEXAGONAL KEY WRENCHES LONG  
CHIAVE ESAGONALE SERIE LUNGA / CHAVE SEXTAVADA SÉRIE LONGA



**BOLA / BOULE / BALL / SFERICA / BOLA**

Ref	Hex	Grid	Box	Stack	Price
0951 5167	1,5 mm	1	5		1,52
0951 5168	2 mm	1	5		1,65
0951 5169	2,5 mm	1	5		1,72
0951 5170	3 mm	1	5		1,75
0951 5171	4 mm	1	5		1,87
0951 5172	5 mm	1	5		2,08
0951 5173	5,5 mm	1	5		2,91
0951 5174	6 mm	1	5		3,33
0951 5175	8 mm	1	5		4,68
0951 5176	10 mm	1	5		7,28

JUEGOS LLAVES HEXAGONALES / JEUX CLES MALES / SET HEXAGONAL KEY WRENCHES / KIT CHIAVI ESAGONALI / JOGO DE CHAVES SEXTAVADAS



**BALL LONG**

Ref	Grid	Down Arrow	Box	Stack	Checkmark
0950 8541	10-ball long	1,5-2-2,5-3-4-5-5, 5-6-8-10	1	24,80	✓

LLAVES HEXAGONALES DE BOLA (PULGADAS) / CLES HEXAGONALES BOULES (POUCES)  
HEXAGONAL KEY WRENCHES BALL (INCHES) / CHIAVI ESAGONALI CON SFERA TERMINALE (POLLICI)  
CHAVES HEXAGONAIS DE BOLA (POLEGADAS)



**PULGADAS / INCHES**

Ref	Hex	Grid	Box	Stack	Price	Ref	Hex	Grid	Box	Stack	Price
0950 8501	0,05"	1	10		0,98	0950 8508	5/32"	1	10		1,96
0950 8502	1/16"	1	10		1,01	0950 8509	3/16"	1	10		1,54
0950 8503	5/64"	1	10		1,04	0950 8510	7/32"	1	10		1,84
0950 8504	3/32"	1	10		1,08	0950 8511	1/4"	1	10		2,00
0950 8505	7/64"	1	10		1,13	0950 8513	5/16"	1	10		2,86
0950 8506	1/8"	1	10		1,29	0950 8514	3/8"	1	10		4,06
0950 8507	9/64"	1	10		1,36						

SET 13 LLAVES HEXAGONALES (ALLEN) DE BOLA (PULGADAS) / SET 13 CLES HEXAGONALES (ALLEN) BOULES (POUCES)  
SET HEXAGONAL KEY WRENCHES (ALLEN) BALL (INCHES) / SET 13 CHIAVI ESAGONALI (ALLEN) CON SFERA TERMINALE (POLLICI)  
CONJUNTO 13 CHAVES HEXAGONAIS (ALLEN) DE BOLA (POLEGADAS)



**PULGADAS / INCHES**

Ref	Down Arrow	Box	Stack	Checkmark
0950 8500	0,05" - 1/16" - 5/64" 3/32" - 7/64" - 1/8" 9/64" - 5/32" - 3/16" 7/32" - 1/4" 5/16" - 3/8"	1	25,00	✓



LLAVES TORX / CLÉS TORX / TORX KEY WRENCHES / CHIAVI TORX / CHAVES TORX



Ref					Ref				
0950 4002	T-7	1	5	2,29	0950 4009	T-27	1	5	3,38
0950 4003	T-8	1	5	2,29	0950 4010	T-30	1	5	3,64
0950 4004	T-9	1	5	2,29	0950 4011	T-40	1	1	4,16
0950 4005	T-10	1	5	2,39	0950 4012	T-45	1	1	4,99
0950 4006	T-15	1	5	2,50	0950 4013	T-50	1	1	6,03
0950 4007	T-20	1	5	2,70	0950 4014	T-55	1	1	8,22
0950 4008	T-25	1	5	3,12	0950 4015	T-60	1	1	9,36

SET LLAVES TORX / JEUX CLES TORX / SET TORX KEY WRENCHES / KIT CHIAVI TORX / JOGO DE CHAVES TORX



Ref				
0950 4000	T-10, T-15, T-20 T-25, T-27, T-30 T-40, T-45, T-50	1	25,99	✓



Ref					
0950 8537	6 - TORX	T10-T15-T20 T25-T27-T30	1	16,80	✓

LLAVES RIBE ACODADAS / CLÉ RIBE COURBEE / CRANKED WRENCH KEY RIBE / CHIAVI RIBE CURVE / CHAVE RIBE CURVA



Ref	M		
0950 4021	4	1	4,82
0950 4022	5	1	5,95
0950 4023	6	1	6,27
0950 4024	7	1	7,87
0950 4025	8	1	9,34
0950 4026	10	1	13,44

JUEGO DE LLAVES RIBE - 7 UNIDADES / JEU DE CLÉS RIBE - 7 PIÈCES / CRANKED WRENCH KEY KIT - 7 PIECES  
 KIT DI CHIAVI - 7 PEZZI / JOGO DE CHAVES RIBE - 7 UNIDADES



Ref			
0950 8542	M4 - M5 - M6 - M7 M8 - M9 - M10	1	52,41



LLAVE AJUSTABLE 1000V MOLETA CENTRAL / CLÉ RÉGLABLE 1000V MOLETTE CENTRALE / ADJUSTABLE SPANNER 1000V, NUT CENTRED  
CHIAVE REGOLABILE 1000V CON VITE CENTRALE / CHAVE AJUSTÁVEL 1000V, AJUSTE CENTRAL



Ref					
0951 4911	25 mm	8"	271 g	1	55,95
0951 4912	33 mm	10"	519 g	1	69,21

LLAVE AJUSTABLE MOLETA CENTRAL - CONFORT / CLÉ RÉGLABLE MOLETTE CENTRALE - CONFORT / ADJUSTABLE SPANNER, NUT CENTRED - CONFORT  
CHIAVE REGOLABILE CON VITE CENTRALE - CONFORT / CHAVE AJUSTÁVEL, AJUSTE CENTRAL - CONFORT



Ref						
0951 4901	20 mm	6"	128 g	1	10	13,26
0951 4902	25 mm	8"	254 g	1	5	15,68
0951 4903	33 mm	10"	482 g	1	5	19,92

LLAVE AJUSTABLE MOLETA LATERAL / CLÉ RÉGLABLE MOLETA LATÉRALE / ADJUSTABLE SPANNER, NUT LATERAL  
CHIAVE REGOLABILE CON VITE LATERALE / CHAVE AJUSTÁVEL, AJUSTE LATERAL



Ref						
0951 4941	25 mm	6"	166 g	1	6	20,97
0951 4942	30 mm	8"	281 g	1	6	25,20
0951 4943	33 mm	10"	500 g	1	6	31,97
0951 4944	40 mm	12"	830 g	1	6	39,79
0951 4945	51 mm	16"	1622 g	1	1	69,86
0951 4946	65 mm	20"	2634 g	1	1	133,30

LLAVE AJUSTABLE MOLETA CENTRAL / CLÉ RÉGLABLE MOLETA CENTRALE / ADJUSTABLE SPANNER, NUT CENTRED  
CHIAVE REGOLABILE CON VITE CENTRALE / CHAVE AJUSTÁVEL, AJUSTE CENTRAL



Ref						
0951 4921	18 mm	4"	64 g	1	10	13,40
0951 4922	25 mm	6"	147 g	1	10	13,95
0951 4923	30 mm	8"	267 g	1	5	16,73
0951 4924	33 mm	10"	452 g	1	5	20,52
0951 4925	38 mm	12"	690 g	1	5	25,59
0951 4926	50 mm	15"	1285 g	1	4	51,24
0951 4927	60 mm	18"	1730 g	1	5	88,89
0951 4928	70 mm	24"	3045 g	1	1	173,54



**LLAVES INGLESAS / CLÉS ANGLAISES / ADJUSTABLE SPANNERS  
CHIAVI INGLESÌ / CHAVE AJUSTÁVEL**

LLAVE AJUSTABLE GRAN APERTURA / CLÉ RÉGLABLE GRANDE OUVERTURE / ADJUSTABLE SPANNER, WIDE OPENING  
CHIAVE REGOLABILE A GRANDE APERTURA / CHAVE AJUSTÁVEL GRANDE ABERTURA



Ref						
<b>0951 4931</b>	35 mm	6"	165 g	1	6	<b>18,91</b>
<b>0951 4932</b>	40 mm	8"	300 g	1	6	<b>23,46</b>
<b>0951 4933</b>	50 mm	10"	525 g	1	5	<b>30,11</b>



Ref					
<b>0951 4950</b>	28 mm	6"	115 g	1	<b>18,51</b>
<b>0951 4951</b>	32 mm	8"	210 g	1	<b>22,72</b>
<b>0951 4952</b>	43 mm	10"	368 g	1	<b>29,48</b>
<b>0951 4953</b>	53 mm	12"	480 g	1	<b>41,91</b>

LLAVE AJUSTABLE GRAN APERTURA REVERSIBLE / CLÉ À MOLETTE GRANDE OUVERTURE RÉVERSIBLE / BIG MOUTH ADJUSTABLE WRENCH REVERSIBLE  
CHIAVE REGOLABILE GRANDE APERTURA REVERSIBILE / CHAVE AJUSTÁVEL DE GRANDE ABERTURA REVERSÍVEL



**REVERSIBLE  
RÉVERSIBLE  
REVERSIBLE  
REVERSIBILE  
REVERSÍVEL**

- ES Mango de goma confort
- FR Manche en caoutchouc pour un meilleur confort
- EN Rubber grip for comfort
- IT Manico in gomma per maggiore comfort
- PT Pega de borracha para mais conforto

Ref					
<b>0951 4960</b>	200 mm	8"	300 g	1	<b>26,90</b>





STILLSON REFORZADA ESTÁNDAR / RENFORCÉE / REINFORCED / RINFORZATA STANDARD / REFORÇADA STANDARD



Ref						
0951 4100	3/4"	8"	300 g	1	6	6,37
0951 4101	1"	10"	650 g	1	6	8,46
0951 4102	1 1/4"	12"	800 g	1	6	10,50
0951 4103	1 1/2"	14"	1100 g	1	6	14,49
0951 4104	2"	18"	1900 g	1	6	19,66
0951 4105	2 1/2"	24"	3100 g	1	1	31,44
0951 4106	4"	36"	6300 g	1	1	54,40

STILLSON HEAVY DUTY / CLÉ SERRE TUBES / HEAVY DUTY WRENCH / IMPEGNO GRAVOSO / CHAVE STILLSON HEAVY DUTTY



Ref						
0951 4107	1"	8"	400 g	1	6	6,54
0951 4108	1 1/2"	10"	800 g	1	6	9,06
0951 4109	2"	12"	1300 g	1	6	12,91
0951 4110	2"	14"	1700 g	1	6	16,33
0951 4111	2 1/2"	18"	2600 g	1	3	26,82
0951 4112	3"	24"	4500 g	1	1	41,09
0951 4113	5"	36"	9500 g	1	1	68,33
0951 4114	6"	48"	14000 g	1	1	580,57
0951 4321	8"	60"	20000 g	1	1	651,91

STILLSON DE ALUMINIO / CLÉ ALLIAGE LÉGER / ALUMINIUM WRENCH / CHIAVE IN ALLUMINIO / CHAVE STILLSON ALUMÍNIO



Ref						
0951 4167	1"	10"	476 g	1	6	20,75
0951 4168	1 1/4"	12"	743 g	1	6	26,62
0951 4115	2"	14"	960 g	1	6	31,15
0951 4116	2 1/2"	18"	1540 g	1	3	39,94
0951 4117	3"	24"	2650 g	1	1	58,76
0951 4118	5"	36"	4960 g	1	1	126,98

LLAVE PARA TUBO "MASTERGRIP" / CLE SERRE-TUBE "MASTERGRIP" / PIPE WRENCH "MASTERGRIP"  
CHIAVE "MASTERGRIP" / CHAVE PARA TUBO "MASTERGRIP"

Diámetros de Tubo / Diámetros de Tube / Tube diameters  
Diámetro del tubo / Diámetros de tubo



Ref				
0951 4128	1/4" - 1 1/2"	10"	1	58,99
0951 4129	1/2" - 2"	14"	1	70,96



LLAVE PARA TUBO MASTERGRIP ALUMINIO / CLÉS SERRE-TUBES / PIPE WRENCH / CHIAVE GIRATUBI / CHAVE PARA TUBO MASTERGRIP ALUMÍNIO



Diámetros de Tubo / Diâmetros de Tube / Tube diameters  
 Diámetro del tubo / Diâmetros de tubo



Ref	∅	↔	📦	📦
0951 4047	3/4" - 3"	18"	1	144,07

LLAVE SUECA 45° / SERRE TUBES SUEDOISE 45° / SWEDISH PIPE WRENCH 45° / CHIAVI SVEDESI 45° / CHAVE MODELO SUECO 45°

45°



Ref	∅	↔	🏋️	📦	📦	📦
0951 4135	1/2"	235 mm	420 g	1	6	53,12
0951 4136	1"	330 mm	750 g	1	6	66,40
0951 4137	1 1/2"	425 mm	1400 g	1	3	89,55
0951 4138	2"	535 mm	2320 g	1	3	139,22

REBABADOR 3-42 MM (1/8" - 1" 5/8") / EBAVUREUR POUR TUBES / PIPE REAMER / SVASATORE / REBARBADOR



Ref	∅	📦	📦	📦	📦
0951 4380	3-42 mm	1	10	11,23	✓



CORTATUBOS / COUPE TUBES / PIPE CUTTER / TAGLIATUBI / CORTA-TUBOS

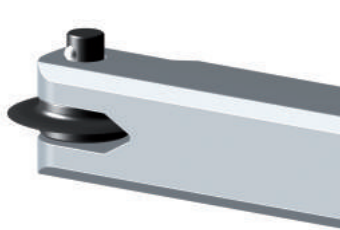

ES Con sistema ICS (instant change system), cambio de cuchilla instantáneo sin necesidad de herramientas. Para tubos de cobre, latón, aluminio, inox y acero de pared delgada.

FR Avec système ICS (instant change system). Changement instantané de la molette sans besoin d'outil. Pommeau ergonomique. Pour tubes en cuivre, laiton, aluminium, inox et tubes en acier à paroi mince.

EN With ICS system (instant change system). No tool required for instant wheel change. Ergonomic knob. For copper, brass, aluminium, stainless steel and thinwalled steel tubes.

IT Con sistema ICS (sistema cambio istantaneo). Cambio lama istantaneo senza necessita' di ulteriore attrezzatura. Manopola ergonomica. Per tubi in rame, ottone, alluminio, inox e in acciaio di spessore sottile.

PT Com sistema ICS (instant change system) troca de lâmina instantanea sem necessidade de ferramentas. Para tubos de cobre, latão, alumínio, inox e aço de parede fina.

ICS

CORTATUBOS 4 RODILLOS CON REBABADOR 3-35 mm (1/8" - 1" 3/8") Y 3-45 mm (1/8" - 1" 3/4") / COUPE TUBES AVEC 4 ROULEAUX  
PIPE CUTTER WITH 4 WHEELS / TAGLIATUBI CON 4 RULLI / CORTA-TUBOS 4 CILINDROS COM REBARBADOR

ICS



STEEL / ALU / CU / INOX

ES 4 rodillos para mejor agarre del tubo. Con rebabador NOGA integrado para diestros y zurdos.

FR Avec 4 rouleaux pour un meilleur accrochage du tube. Avec ebavureur NOGA pour droits et gauchers.

EN With 4 rolls for a better hold of the tube. NOGA professional reamer for right and left handed included.

IT 4 rulli per una presa migliore del tubo. Con sbavatore NOGA integrato per destri e mancini.

PT 4 cilindros para uma melhor aderência do tubo. Com rebardador NOGA integrado para direitos e canhotos.

Ref	Ø				
0951 4365	3-35 mm	1	3	38,99	✓
0951 4366	3-45 mm	1	3	44,35	✓

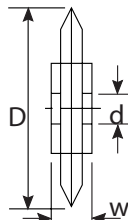

Cuchilla para cortar tubos / Molette recharge  
Spare wheel for pipe cutter / Rotella per cortatubi  
Lâmina para cortar tubos

Ref	D	d	w				
0951 4370	19 mm	5 mm	5 mm	1	30	3,48	

CORTATUBOS 4 RODILLOS PARA TUBOS DE METAL 6-76 mm / COUPE TUBES / PIPE CUTTER WITH 4 WHEELS FOR METAL TUBES  
TAGLIATUBI CON 4 RULLI PER TUBI IN METALLO / CORTA-TUBOS 4 CILINDROS PARA TUBOS DE METAL

ICS



STEEL / ALU / CU / INOX

ES 4 rodillos para mejor agarre del tubo.

FR Avec 4 rouleaux pour un meilleur accrochage du tube.

EN With 4 rolls for a better hold of the tube.

IT 4 Rulli per una presa migliore del tubo.

PT 4 cilindros para uma melhor aderência do tubo.

Ref	Ø			
0951 4375	6-76 mm	1	74,96	✓

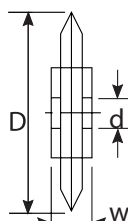

Cuchilla para cortar tubos / Molette recharge  
Spare wheel for pipe cutter / Rotella per cortatubi  
Lâmina para cortar tubos

Ref	D	d	w				
0951 4371	19 mm	4,85 mm	6,20 mm	1	50	3,38	



CORTATUBOS 4 RODILLOS PARA TUBOS DE PLÁSTICO 6-76 mm / COUPE TUBES / PIPE CUTTER WITH 4 WHEELS FOR PLASTIC TUBES  
TAGLIATUBI CON 4 RULLI PER TUBI IN PLASTICA / CORTA-TUBOS 4 CILINDROS PARA TUBOS DE PLÁSTICO

## ICS



### PLÁSTICO Y MULTICAPAS PVC AND MULTILAYER

ES 4 rodillos para mejor agarre del tubo.  
FR Avec 4 rouleaux pour un meilleur accrochage du tube.  
EN With 4 rolls for a better hold of the tube.  
IT 4 Rulli per una presa migliore del tubo.  
PT 4 cilindros para uma melhor aderência do tubo.

Ref	Ø			
0951 4376	6-76 mm	1	83,49	✓

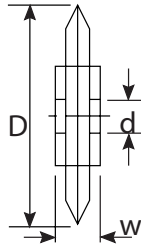

Cuchilla para cortar tubos / Molette recharge  
Spare wheel for pipe cutter / Rotella per cortatubi  
Lâmina para cortar tubos

Ref	D	d	w			
0951 4372	26 mm	4,85 mm	6,20 mm	1	6,71	✓

CORTATUBOS 4 RODILLOS PARA INOX 6-76 mm / COUPE TUBE 4 LAMES ROTATIVES / PIPE CUTTER WITH 4 WHEELS FOR ST. STEEL  
TAGLIACAVI 4 RULLI PER INOX / CORTA-TUBOS 4 CILINDROS PARA INOX

## ICS



### INOX



Ref	Ø			
0951 4377	6-76 mm	1	103,27	✓

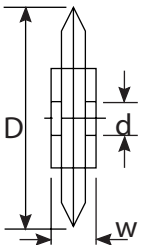

Cuchilla recambio 19x6,2 inox con corona agujas / Lame de rechange inox avec couronne d'aiguilles.  
Cutter spare part / Lama ricambio inox con corona dentellata.  
Lâmina de reposição inox coroa de agulhas.

Ref	D	d	w			
0951 4378	19 mm	4,85 mm	6,20 mm	1	6,40	✓

CORTATUBOS MINI ZAMAK 3-25 mm (1/8" - 1") Y 3-30 mm (1/8" - 1 1/8") / MINI COUPE TUBES / MINI PIPE CUTTER  
MINI TAGLIATUBI / CORTA-TUBOS MINI ZAMAK

## ICS



### STEEL / ALU / CU / INOX

Ref	Ø				
0951 4360	3-25 mm	1	10	16,99	✓
0951 4361	3-30 mm	1	10	21,45	✓

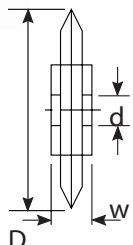

Cuchilla para cortar tubos / Molette recharge  
Spare wheel for pipe cutter / Rotella per cortatubi  
Lâmina para cortar tubos

Ref	D	d	w			
0951 4370	19 mm	5 mm	5 mm	1	10	3,48



CORTATUBOS 2 RODILLOS 3-30 mm (1/8" - 1" 1/8") / COUPE TUBES AVEC 2 ROULEAUX / PIPE CUTTER WITH 2 WHEELS  
TAGLIATUBI CON 2 RULLI / CORTA-TUBOS 2 CILINDROS

STEEL / ALU / CU / INOX

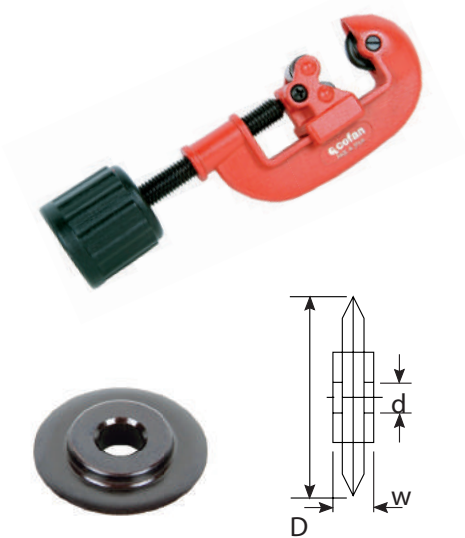

Ref	Ø				
0951 4362	3-30 mm	1	5	17,75	✓

Cuchilla para cortar tubos / Molette recharge  
Spare wheel for pipe cutter / Rotella per cortatubi  
Lâmina para cortar tubos

Ref	D	d	w			
0951 4370	19 mm	5 mm	5 mm	1	50	3,48

CORTATUBOS TIJERA PARA PLÁSTICO / COUPE TUBES POUR PLASTIQUE / PLASTIC TUBE CUTTER  
TAGLIATUBI PER TUBI IN PLASTICA / TESOURA CORTA-TUBOS PLÁSTICO

ICS



26 mm (1")

Material: PE, PP, PB, PEX, MLP/MSR, VPE, CPVC, PVC, PVDF



Spare blades

Ref	Ø				
0951 4381	26 mm - 1"	1	4	38,46	✓

Ref			
0951 4383	1	15,29	✓

ICS



35 mm (1" - 3/8")

Material: PE, PP, PB, PEX, MLP/MSR, VPE, CPVC, PVC, PVDF



Spare blades

Ref	Ø				
0951 4382	35 mm - 1" 3/8"	1	4	50,36	✓

Ref			
0951 4384	1	23,82	✓

ICS



45 mm (1" 5/8)

Material: PE, PP, PB, PEX, MLP/MSR, VPE, CPVC, PVC, PVDF



Spare blades

Ref	Ø				
0951 4385	42 mm - 1" 5/8"	1	4	66,44	✓

Ref			
0951 4387	1	27,98	✓

ICS



63 mm (2" 1/2)

Material: PE, PP, PB, PEX, MLP/MSR, VPE, CPVC, PVC, PVDF



Spare blades

Ref	Ø				
0951 4386	63 mm - 2" 1/2"	1	4	100,57	✓

Ref			
0951 4388	1	50,32	✓





CORTATUBOS TIJERA MULTICAPA / CISEAU MULTICOUCHE COUPE TUBE / MULTILAYER PIPE CUTTER  
CESOIA TAGLIATUBI MULTISTRATO / CORTA-TUBOS TESOURA MULTI CAMADA

TUBOS MULTICAPA / MULTILAYER PIPE



Ref	∅			
0951 4389	26 mm (1")	1	50	61,40

CORTAMANGUERAS TIJERA / CISEAU COUPE TUBE / PIPE CUTTER FOR HOSE / CESOIA TAGLIATUBI / CORTA-MANGUEIRAS TESOURA



Ref	∅			
0951 4395	14 mm (9/16")	1	60	32,41



Ref	∅			
0951 4396	28 mm (1" 1/8")	1	50	52,87

DESATASCADOR DE MUELLE / DÉBOUCHEUR / SPRING PIPE CLEANER / MOLLA LIBERA TUBI / DESENTUPIDOR DE CANOS TIPO MOLA



Ref	↔			
0951 4207	3 m	1	12	11,83
0951 4208	5 m	1	20	42,25
0951 4209	10 m	1	12	76,04

DESATASCADOR DE TAMBOR / DÉBOUCHEUR / PIPE CLEANER / LIBERA TUBI A TAMBORO / DESENTUPIDOR DE TAMBOR



Ref	↔		
0951 4210	4,6 m	1	59,15



TENAZAS CURVATUBOS / PINCE A CINTRER / TUBE BENDER / TENAGLIA CURVATUBI / CURVADOR DE TUBOS

180°



Ref	Ø		
0951 4195	6	1	72,03
0951 4196	8 - 5/16"	1	85,58
0951 4197	10	1	89,18
0951 4198	12	1	95,49
0951 4199	14	1	114,43
0951 4200	15	1	116,91
0951 4201	16 - 5/8"	1	128,72
0951 4202	1/4"	1	88,59
0951 4203	3/8"	1	99,25
0951 4204	1/2"	1	139,30

180°



Ref	Ø		
0951 4205	1/8" - 3/16" - 1/4"	1	43,21
0951 4206	1/4" - 5/16" - 3/8"	1	44,29

ABOCINADORES / APPAREIL A BATTRE COLLETS / FLARING TOOL / FLANGIATUBI / QUEIMA FERRAMENTA



Ref				
0951 4213	3/16" - 1/4"	1	2	82,66
	5/16" - 3/8"			
	1/2" - 5/8"			

LLAVE DE LAVABO / CLE LAVABO / BASIN WRENCH / CHIAVE LAVABO / CHAVE DE LAVATÓRIO



Ref				
0951 4216	288 mm	1	6	33,79



Ref				
0951 4217	460 mm	1	6	50,71



LLAVE FILTROS AUTORREGULABLE / CLÉ FILTRES AUTORÉGLABLE / OIL FILTER WRENCH CLAW TYPE  
CHIAVE FILTRI AUTOREGOLABILI / CHAVE FILTROS AUTO REGULÁVEL



Ref	Ø		
0950 3250	65 - 110 mm	1	28,56

LLAVE AJUSTABLE PARA FILTROS ACEITE / CLÉ RÉGLABLE POUR FILTRES A HUILE / SWIVEL HANDLE OIL FILTER WRENCH  
CHIAVE REGOLABILE PER FILTRO OLIO / CHAVE AJUSTÁVEL PARA FILTROS DE ÓLEO



Ref	Ø		
0950 3255	60 - 73 mm	1	22,95
0950 3256	73 - 85 mm	1	23,36
0950 3257	85 - 95 mm	1	24,24
0950 3258	95 - 110 mm	1	25,09

TENAZA PARA FILTROS DE ACEITE / TENAILLES POUR FILTRES D'HUILE / OIL FILTER WRENCH  
TENAGLIA PER FILTRO OLIO / ALICATE PARA FILTROS DE ÓLEO



Ref	Ø		
0950 3259	60 - 90 mm	1	29,68

LLAVE DE CORREA / CLÉ A SANGLE / STRAP WRENCH / CHIAVE A CINGHIA / CHAVE DE CORREIA



Ref	↔	Ø			
0951 4153	450 mm	3"	270 g	1	60,35
0951 4154	1000 mm	8"	290 g	1	71,69



RECAMBIO / SPARE PART

Ref	Ø			
0951 4155	3"	120 g	1	12,88
0951 4156	8"	210 g	1	14,44



LLAVE DE CADENA REVERSIBLE / CLÉ À CHAÎNE REVERSIBLE / REVERSIBLE CHAIN WRENCH  
CHIAVE A CATENA REVERSIBILE / CHAVE DE CORRENTE REVERSÍVEL



Ref	↔	∅	⚖️	📦	📦	📦
0951 4143	300 mm	4"	750 g	1	6	76,04



RECAMBIO / SPARE PART

Ref	∅	⚖️	📦	📦
0951 4144	4"	290 g	1	29,60

LLAVE DE CADENA REVERSIBLE "REFORZADA" / CLÉ À CHAÎNE REVERSIBLE "RENFORCÉES" / REVERSIBLE CHAIN WRENCH "REINFORCED"  
CHIAVE A CATENA REVERSIBILE "RINFORZATA" / CHAVE DE CORRENTE REVERSÍVEL "REFORÇADA"



Ref	↔	∅	⚖️	📦	📦
0951 4145	900 mm	4"	5800 g	1	253,49
0951 4146	900 mm	6"	6500 g	1	482,31
0951 4147	1100 mm	8"	12500 g	1	629,78
0951 4148	1100 mm	10"	14800 g	1	881,81



RECAMBIO / SPARE PART

Ref	∅	⚖️	📦	📦
0951 4149	4"	980 g	1	49,16
0951 4150	6"	1325 g	1	73,33
0951 4151	8"	2790 g	1	91,00
0951 4152	10"	3520 g	1	112,93

LLAVES DE GANCHO / CLÉ CROCHET / HOOK WRENCH / CHIAVI A GANCIO / CHAVE DE GANCHO



Ref	∅	📦	📦
0951 2231	16-20	1	10,11
0951 2232	25-28	1	10,11
0951 2233	30-32	1	10,11
0951 2234	34-36	1	13,19
0951 2235	40-42	1	14,48
0951 2236	45-50	1	14,80
0951 2237	52-55	1	15,68
0951 2238	58-62	1	17,34
0951 2239	68-75	1	17,34
0951 2241	80-90	1	30,09
0951 2243	95-100	1	30,09
0951 2244	110-115	1	40,11
0951 2245	120-130	1	41,67
0951 2246	135-145	1	59,33
0951 2247	150-165	1	80,28



**LLAVES PARA RUEDAS / CLÉS POUR ROUES / WHEEL WRENCHES  
CHIAVI RUOTA / CHAVES PARA RODAS**

**Cr/V**

LLAVE EN CRUZ PARA CAMIÓN Y TURISMO / CAMIONS ET VOITURES / TRUCK AND CAR  
CAMION E AUTOVETTURA / CHAVES EM CRUZ PARA CAMIÕES E CARROS



Ref					
0940 0053	17x19x21x1/2"	380 mm	1		13,48
0940 0054	24x27x32x3/4"	625 mm	1		47,50



Ref					
0951 3230	17x19x22x13/16"	380 mm	1		13,50

LLAVES DE RUEDAS PARA CAMIÓN Y AUTOCAR / CAMINONS ET BUS TRUCK / TRUCK AND BUS / CAMION E AUTOBUS / CAMIÃO E AUTOCARRO



Ref						
0940 0050	24 x 27	400 mm	2000 g	1		28,08
0940 0051	27 x 30	400 mm	2000 g	1		28,08
0940 0052	30 x 32	400 mm	2870 g	1		28,08

LLAVES EXTENSIBLES PARA RUEDAS (SW 17-19) / CLÉS À ROUES EXTENSIBLE / EXTENSIBLE WHEEL WRENCH  
ESTENSIBILE PER RUOTE / CHAVE PARA RODAS EXTENSÍVEL



Ref						
0951 3232	17-19	550 mm	1	3		60,62

LLAVES DE BUJÍAS ARTICULADAS / CLÉS A BOUGIE ART / SPARK PLUG WRENCH / SNODATA, DA CANDELE / CHAVE DE VELAS DE IGNIÇÃO



Ref					
0951 3233	16x240 mm - 5/8"	1	5		4,95
0951 3234	21x240 mm - 13/16"	1	5		4,95





CEPILLOS PARA MADERA / RABOTS / JACK PLANES / PIALLA / PLAINAS



Ref	↔	📦	📦
0951 4249	250 mm	1	90,66
0951 4250	350 mm	1	106,40

FORMONES / CISEAUX A BOIS / FIRMER CHISELS / CESELLI DI LEGNO / FORMÕES

Bimaterial  
Cromo



Ref	↔	📦	📦
0951 4251	6 mm	1	15,65
0951 4252	8 mm	1	15,80
0951 4253	10 mm	1	16,12
0951 4254	12 mm	1	16,80
0951 4255	14 mm	1	17,38
0951 4256	15 mm	1	17,99
0951 4257	16 mm	1	18,38
0951 4258	18 mm	1	18,81
0951 4259	20 mm	1	19,75
0951 4260	22 mm	1	20,75
0951 4261	25 mm	1	22,42
0951 4262	30 mm	1	24,36
0951 4263	32 mm	1	26,65
0951 4264	35 mm	1	28,85

SARGENTOS / SERRE JOINTS / CLAMPS / MORSETTI / GRAMOS

Mod. G



Ref	L	A	📦	📦	📦
0951 4233	50 mm	30 mm	1	6	10,76
0951 4234	75 mm	52 mm	1	6	19,91
0951 4235	100 mm	60 mm	1	6	24,44
0951 4236	150 mm	75 mm	1	3	29,70
0951 4237	200 mm	83 mm	1	3	37,89

Mod. F



Ref	L	A	📦	📦	📦
0951 4238	150 mm	50 mm	1	6	18,50
0951 4239	200 mm	50 mm	1	6	18,45
0951 4240	200 mm	80 mm	1	6	19,53
0951 4241	250 mm	80 mm	1	6	20,13
0951 4243	300 mm	120 mm	1	2	37,82
0951 4244	400 mm	120 mm	1	2	40,25
0951 4246	600 mm	120 mm	1	2	44,56
0951 4247	800 mm	120 mm	1	2	49,46
0951 4248	1.000 mm	120 mm	1	2	53,69



LIMAS DE MEDIA CAÑA / LIMES DEMI-RONDES / HALF-ROUND FILES / LIMA SEMITONDA / LIMAS DE MEIA CANA

Modelo/Model 1: basta / batarde / bastard / bastardo / grossa

Modelo/Model 2: entrefina / demi douce / 2nd cut / mezzo dolce / média

Modelo/Model 3: fina / douce / smooth / dolce / fina

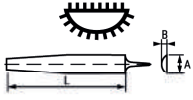

Ref	L	MODEL		A	B			
0951 6002	100 mm	2	A	10 mm	3 mm	1	12	11,95
0951 6005	150 mm	2	B	15 mm	4 mm	1	12	12,73
0951 6007	200 mm	1	C	20 mm	5,5 mm	1	12	14,18
0951 6008	200 mm	2	C	20 mm	5,5 mm	1	12	15,04
0951 6009	200 mm	3	C	20 mm	5,5 mm	1	12	16,52
0951 6010	250 mm	1	D	24 mm	7 mm	1	12	18,75
0951 6011	250 mm	2	D	24 mm	7 mm	1	12	19,69
0951 6012	250 mm	3	D	24 mm	7 mm	1	12	20,57
0951 6014	300 mm	2	E	29 mm	8,2 mm	1	6	24,97
0951 6017	350 mm	2	E	34 mm	9,5 mm	1	6	28,84

LIMA TRIANGULAR / LIMES TRIANGULAIRES / THREE SQUARE FILES / LIMA TRIANGOLARE / LIMA TRIANGULARE

Modelo/Model 1: basta / batarde / bastard / bastardo / grossa

Modelo/Model 2: entrefina / demi douce / 2nd cut / mezzo dolce / média

Modelo/Model 3: fina / douce / smooth / dolce / fina

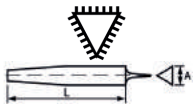

Ref	L	MODEL		A			
0951 6020	100 mm	2	A	7 mm	1	12	10,71
0951 6023	150 mm	2	B	10 mm	1	12	10,43
0951 6025	200 mm	1	C	14 mm	1	12	13,61
0951 6026	200 mm	2	C	14 mm	1	12	13,63
0951 6027	200 mm	3	C	14 mm	1	12	15,69
0951 6028	250 mm	1	D	17 mm	1	12	16,14
0951 6029	250 mm	2	D	17 mm	1	12	16,92
0951 6030	250 mm	3	D	17 mm	1	12	18,75
0951 6032	300 mm	2	E	20 mm	1	6	26,89
0951 6035	350 mm	2	E	23 mm	1	6	31,58

LIMA TRIANGULAR DELGADA PARA AFILADO / LIME TRIANGOLAIRE ETROITE / SLIM TAPER SAW FILE  
LIMA TRIANGOLARE SOTTILE PER AFFILARE / LIMA TRIANGULAR FINA AGUÇADA

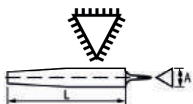

Modelo/Model 4: extrafina / extrafine / dead smooth / dolcissimo / extra fina

Ref	L	MODEL		A			
0951 6117	100 mm	4	A	4,5 mm	1	12	7,97
0951 6118	125 mm	4	B	5,0 mm	1	12	9,16

LIMA TRIANGULAR EXTRADELGADA PARA AFILADO / LIME EXTRA-FINE TRIANGOLAIRE POUR AFFÛTAGE / EXTRA-SLIM TAPER SAW FILE  
LIMA TRIANGOLARE EXTRA-SOTTILE PER AFFILARE / LIMA TRIANGULAR EXTRA FINA AGUÇADA

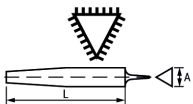

Modelo/Model 4: extrafina / extrafine / dead smooth / dolcissimo / extra fina

Ref	L	MODEL		A			
0951 6119	100 mm	4	A	3,6 mm	1	12	8,75
0951 6120	125 mm	4	B	4,2 mm	1	12	9,66

LIMA PLANA / LIME PLATE / FARMER'S OWN FILE / LIMA PIATTA / LIMA PLANA

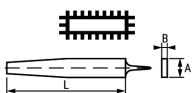

Model 2: entrefina / demi douce / 2nd cut / mezzo dolce / média

Ref	L	MODEL	A	B			
0951 6108	200 mm	2	25 mm	5 mm	1	12	11,96



LIMA UNIVERSAL PARALELA ENTREFINA / LIME UNIVERSELLE PARALLELE ENTREFINE / FLAT FILE SECOND CUT  
LIMA PIATTA PARALLELA / LIMA UNIVERSAL PARALELA MÉDIA

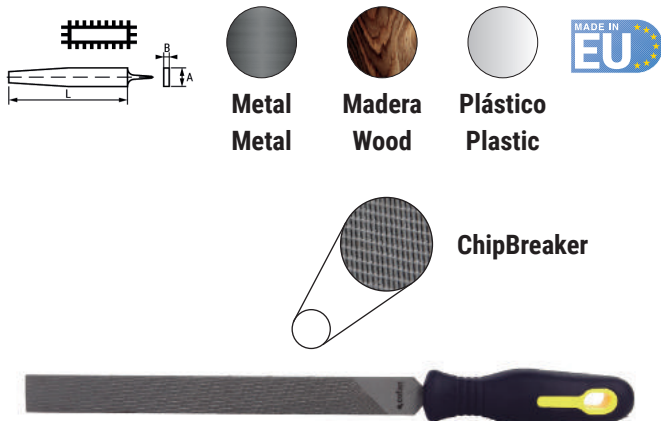

- Metal**  
**Metal**
- Madera**  
**Wood**
- Plástico**  
**Plastic**

**ChipBreaker**

ES Lima universal especial con ranuras longitudinales (también llamado «ChipBreaker») en ambos lados para trabajar con metales blandos y plásticos duros, ya que elimina el material rápidamente y evita que la lima se emboce. Lima indicada para usar en fierros, bronce, latón, plásticos y maderas.

FR Lime universelle spéciale avec rainures longitudinales (également appelées « ChipBreaker ») des deux côtés pour travailler les métaux mous et les plastiques durs, car elle enlève rapidement la matière et empêche la lime de s'engorger. Lime indiquée pour une utilisation sur le fer, le bronze, le laiton, les plastiques et le bois.

EN The special diamond pattern, also acts as a chip breaker, removes the material quickly and reduces chip clogging. It can be used on soft metals and hard plastic. Also suitable for iron, bronze, brass, plastic and wood.

IT Questa lima con un speciale profilo a rombi nelle due lati rimuove rapidamente il materiale e riduce l'intasamento del truciolo. Adatto per metalli teneri e plastici rigidi. Può essere usato per ferro, bronzo, ottone, plastica e legno.

PT Lima universal com ranhuras longitudinais (também chamado de « ChipBreaker») em ambos os lados para trabalhar com metais suaves e plásticos duros, já que elimina o material rapidamente e evita que a lima se obstrua. Lima indicada para usar em ferros, bronze, latão, plásticos e madeira.

Ref	L	A	B				
0951 6155	250 mm	24 mm	6 mm	D	1	12	21,43

LIMA PLANA PARALELA / LIMES PLATES PARALLELES / FLAT FILE  
LIMA PIATTA PARALLELA / LIMA CHATA PARALELA

- Modelo/Model 1: basta / batarde / bastard / bastardo / grossa
- Modelo/Model 2: entrefina / semi douce / 2nd cut / mezzo dolce / média
- Modelo/Model 3: fina / douce / smooth / dolce / fina



Ref	L	MODEL		A	B			
0951 5180	100 mm	2	A	11 mm	2,5 mm	1	12	8,98
0951 5183	150 mm	2	B	15 mm	3,5 mm	1	12	9,54
0951 5185	200 mm	1	C	20 mm	4,5 mm	1	12	11,39
0951 5186	200 mm	2	C	20 mm	4,5 mm	1	12	11,84
0951 5187	200 mm	3	C	20 mm	4,5 mm	1	12	12,41
0951 5188	250 mm	1	D	24 mm	6 mm	1	12	14,57
0951 5189	250 mm	2	D	24 mm	6 mm	1	12	15,57
0951 5190	250 mm	3	D	24 mm	6 mm	1	12	15,90
0951 5192	300 mm	2	E	29 mm	6,5 mm	1	6	19,94
0951 5195	350 mm	2	E	33,5 mm	7,5 mm	1	6	25,55

LIMA PLANA DE PUNTA / LIMES PLATES DE BOUT / FLAT FILE  
LIMA PIATTA APPUNTITA / LIMA CHATA AGULHA

- Modelo/Model 1: basta / batarde / bastard / bastardo / grossa
- Modelo/Model 2: entrefina / semi douce / 2nd cut / mezzo dolce / média
- Modelo/Model 3: fina / douce / smooth / dolce / fina



Ref	L	MODEL		A	B			
0951 6055	100 mm	2	A	11 mm	2,5 mm	1	12	9,04
0951 6058	150 mm	2	B	15 mm	3,5 mm	1	12	10,26
0951 6060	200 mm	1	C	20 mm	4,5 mm	1	12	11,75
0951 6061	200 mm	2	C	20 mm	4,5 mm	1	12	12,03
0951 6062	200 mm	3	C	20 mm	4,5 mm	1	12	12,59
0951 6063	250 mm	1	D	24 mm	6 mm	1	12	14,85
0951 6064	250 mm	2	D	24 mm	6 mm	1	12	15,44
0951 6065	250 mm	3	D	24 mm	6 mm	1	12	16,26
0951 6067	300 mm	2	E	29 mm	6,5 mm	1	6	20,33
0951 6070	350 mm	2	E	33,5 mm	7,5 mm	1	6	25,17

LIMA CUADRADA / LIMES CARRÉES / SQUARE FILE  
LIMA QUADRATA / LIMA QUADRADA

- Modelo/Model 1: basta / batarde / bastard / bastardo / grossa
- Modelo/Model 2: entrefina / semi douce / 2nd cut / mezzo dolce / média
- Modelo/Model 3: fina / douce / smooth / dolce / fina

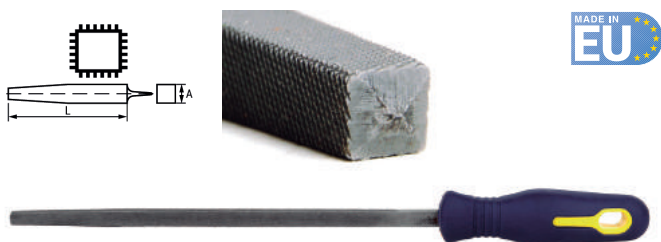

Ref	L	MODEL		A			
0951 6073	100 mm	2	A	3,8 mm	1	12	10,26
0951 6076	150 mm	2	B	5,6 mm	1	12	10,70
0951 6078	200 mm	1	C	7,5 mm	1	12	12,11
0951 6079	200 mm	2	C	7,5 mm	1	12	12,51
0951 6080	200 mm	3	C	7,5 mm	1	12	12,80
0951 6081	250 mm	1	D	9,5 mm	1	12	14,57
0951 6082	250 mm	2	D	9,5 mm	1	12	15,44
0951 6083	250 mm	3	D	9,5 mm	1	12	16,26
0951 6085	300 mm	2	E	11,5 mm	1	6	21,79
0951 6088	350 mm	2	E	14,5 mm	1	6	28,36



LIMAS AFILADO PARA CADENA DE MOTOSIERRA / FICHIERS D'AFFÛTAGE POUR CHAÎNE DE TRONÇONNEUSE / ROUND OR FLAT CHAINSAW FILES  
LIMA PER CATENA MOTOSEGA / LIMA AFIADA PARA CORRENTES DE MOTO SERRA

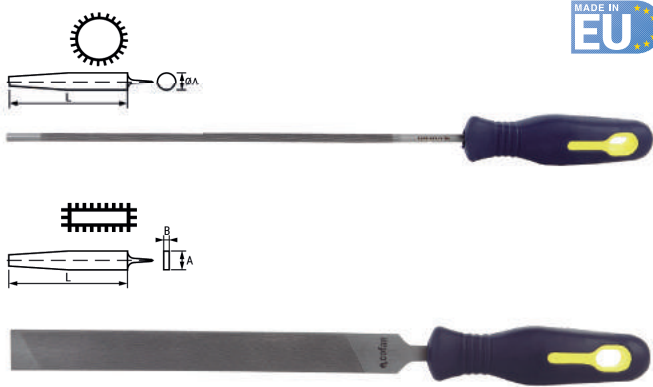

Para/For:



Ref	L	Ø			
0951 6150	200 mm	4,0 mm	A	1	5,82
0951 6151	200 mm	4,8 mm	B	1	5,82
0951 6152	200 mm	5,5 mm	B	1	6,24

Ref	L	A	B			
0951 6153	150 mm	15 mm	3,0 mm	B	1	9,00

LIMAS REDONDAS / LIMES RONDES / ROUND FILES / LIME TONDE / LIMA REDONDA

Modelo/Model 1: basta / batarde / bastard / bastardo / grossa

Modelo/Model 2: entrefina / semi douce / 2nd cut / mezzo dolce / média

Modelo/Model 3: fina / douce / smooth / dolce / fina



Ref	L	MODEL		A			
0951 6091	100 mm	2	A	4 mm	1	12	8,43
0951 6094	150 mm	2	B	5,5 mm	1	12	9,55
0951 6096	200 mm	1	C	7,5 mm	1	12	10,74
0951 6097	200 mm	2	C	7,5 mm	1	12	11,14
0951 6098	200 mm	3	C	7,5 mm	1	12	11,68
0951 6099	250 mm	1	D	9,5 mm	1	12	13,52
0951 6100	250 mm	2	D	9,5 mm	1	12	14,19
0951 6101	250 mm	3	D	9,5 mm	1	12	14,84
0951 6103	300 mm	2	E	11,5 mm	1	6	18,99
0951 6106	350 mm	2	E	14,5 mm	1	6	21,99

LIMA CUCHILLO ENTREFINA DOBLE PICADO / LIME COUPEAU MI DOUCE DOUBLE PIC / KNIFE EDGE SECOND CUT FILE DOUBLE CUT TEETH  
LIMA A COLTELLO A TAGLIO MEZZO DOLCE E INCROCIATO / LIMA DE FACA DUPLO PICADO



Ref	L	MODEL		A	B		
0951 6160	150 mm	2	B	17 mm	4,5 mm	1	20,30
0951 6161	200 mm	2	C	21 mm	5,0 mm	1	28,27

LIMA DE PUNTA ENTREFINA PARA LLAVES / LIME POINTE MI DOUCE POUR LES CLES / SECOND CUT WARDING FILE  
LIMA PER CHIAVI A TAGLIO MEZZO DOLCE / LIMA DE PONTA PARA CHAVES



Para/For:

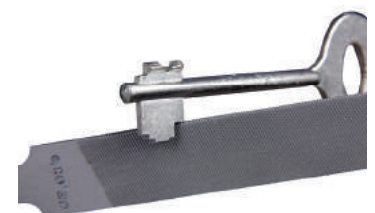

Ref	L	MODEL		A	B		
0951 6165	150 mm	3	B	16 mm	2,0 mm	1	23,74



ESCOFINA PLANA PARALELA / RAPES PLATES PARALLELES / FLAT RASP / RASPA PIATTA PARALLELA / GROSA PLANA PARALELA

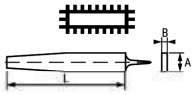

Modelo/Model 3: fina / douce / smooth / dolce / fina



Ref	L		A	B			
0951 6109	250 mm	D	25 mm	7,0 mm	1	6	17,37
0951 6110	300 mm	E	30 mm	7,5 mm	1	6	21,47

ESCOFINA MEDIA CAÑA / RAPES DEMI-ROND / HALF ROUND RASP / RASPA SEMITONDA / GROSA MEIA CANA

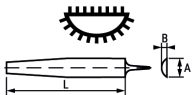

Modelo/Model 3: fina / douce / smooth / dolce / fina



Ref	L		A	B			
0951 6111	150 mm	B	15 mm	5 mm	1	6	14,32
0951 6112	200 mm	C	20 mm	6,5 mm	1	6	19,46
0951 6113	250 mm	D	24 mm	7,5 mm	1	6	23,95
0951 6114	300 mm	E	29 mm	9,0 mm	1	6	27,84

ESCOFINA REDONDA / RAPES RONDES / ROUND RASP / RASPA TONDA / GROSA REDONDA

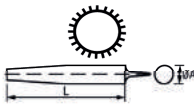

Modelo/Model 3: fina / douce / smooth / dolce / fina



Ref	L		Ø			
0951 6115	200 mm	C	10,0 mm	1	6	13,19
0951 6116	250 mm	D	12,5 mm	1	6	16,26

ESCOFINA DE HERRADOR NORMAL 6 DIENTES / BROSE A CHEVAL NORMALE 6 DENTS / HORSE RASP 6 TEETH  
RASPA E LIMA PER CAVALLI 6 DENTI / GROSA NORMAL DE 6 DENTES



Para/For:

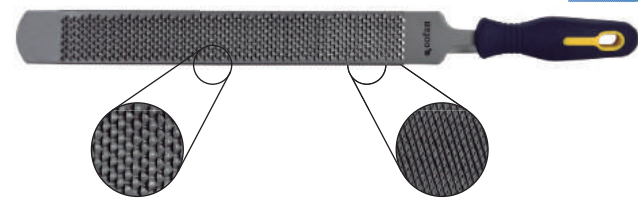

ANVERSO / FRONT

REVERSO / BACK

Ref	L	MODEL	A	B			
0951 6171	350 mm	Normal	45 mm	5 mm	E	1	46,27

MANGO ERGONÓMICO PARA LIMA / POIGNÉE ERGONOMIQUE POUR LIME / ERGONOMIC FILE HANDLE  
MANICO ERGONOMIC PER LIME / PEGA ERGONÓMICA PARA LIMA

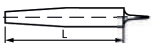

COD.	Ref	L		
A	0951 6141	100 mm	1	2,80
B	0951 6142	125-150 mm	1	2,80
C	0951 6143	200 mm	1	2,80
D	0951 6144	250 mm	1	2,80
E	0951 6145	300-350 mm	1	2,80





JUEGO DE LIMAS PARA LLAVES 6UDS. / JEU DE LIMES POUR CLÉS 6 PCS. / 6 PIECE WARDING FILE SET  
SET DI 6 LIME PER CHIAVI / JOGA DE LIMAS PARA CHAVES 6 UNI.



6 Uds

Para/For:

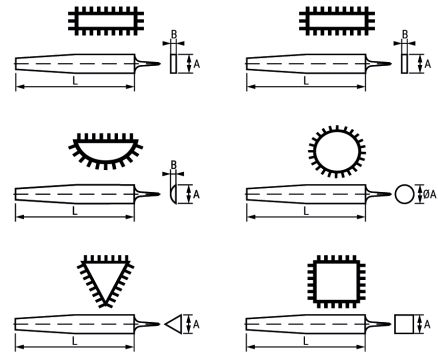

Ref	↓	L	MODEL	📦	📦
0951 6166	6	100 mm	3	1	38,82

JUEGO DE LIMAS DE AGUJA / JEU DE LIMES / NEEDLE FILES SET / SET DI LIME AD AGO / JOGO DE LIMA DE AGULHA



6 Uds

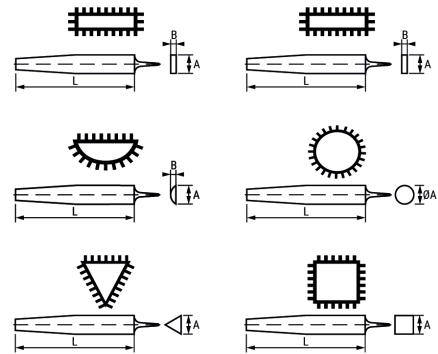

12 Uds

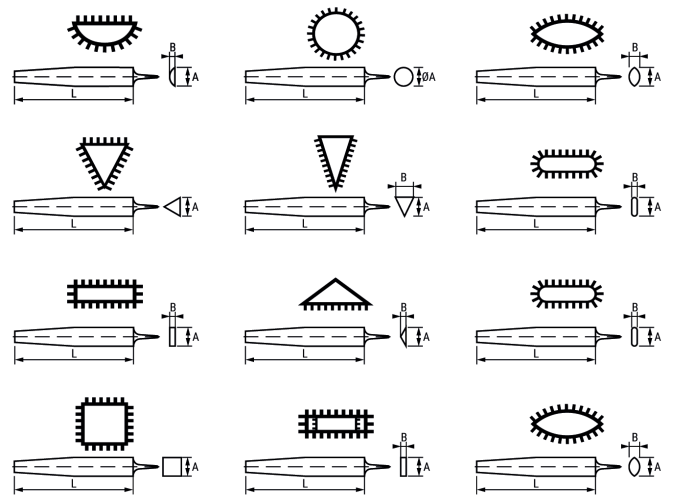

Ref	↓	L	MODEL	📦	📦
0951 6135	6	140 mm	3	1	45,32
0951 6136	12	140 mm	3	1	85,50





LIMA DE AGUJA PLANA PARALELA / LIMES PLATES PARALLÈLES / FLAT NEEDLE FILE  
LIMA AD AGO PIATTA APPUNTITA / LIMA DE AGULHA CHATA PARALELA

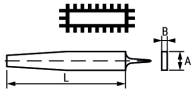

Ref	L	MODEL	A	B			
0951 6129	140 mm	3	5,8 mm	1,5 mm	1	12	8,76

LIMA DE AGUJA PLANA PUNTA / LIMES PLATES POINTES / FLAT WARDING NEEDLE FILE / LIMA AD AGO PIATTA / LIMA AGULHA CHATA COM PONTA

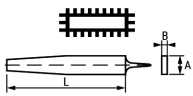

Ref	L	MODEL	A	B			
0951 6130	140 mm	3	5,2 mm	1,5 mm	1	12	8,76

LIMA DE AGUJA DE MEDIA CAÑA / LIMES DEMI-RONDES / HALF-ROUND NEEDLE FILE / LIMA AD AGO SEMITONDA / LIMA AGULHA MEIA CANA

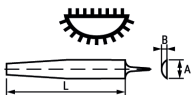

Ref	L	MODEL	A	B			
0951 6131	140 mm	3	5,3 mm	2,0 mm	1	12	14,03

LIMA DE AGUJA REDONDA / LIME RONDE / ROUND NEEDLE FILE / LIMA AD AGO TONDA / LIMA AGULHA REDONDA

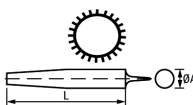

Ref	L	MODEL	A			
0951 6132	140 mm	3	Ø 3 mm	1	12	8,06

LIMA DE AGUJA TRIANGULAR / LIME TRIANGULAIRE / THREE SQUARE NEEDLE FILE / LIMA AD AGO TRIANGOLARE / LIMA AGULHA TRIANGULAR

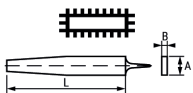

Ref	L	MODEL	A			
0951 6133	140 mm	3	3,3 mm	1	12	8,70

LIMA DE AGUJA CUADRADA / LIME CARRÉE / SQUARE NEEDLE FILE / LIMA AD AGO QUADRATA / LIMA AGULHA QUADRADA

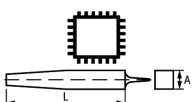

Ref	L	MODEL	A			
0951 6134	140 mm	3	2,8 mm	1	12	8,16



POLVO AZUL PARA PLOMADA / POUDRE BLEUE POUR MARQUAGE / MARKING BLUE POWDER  
POLVERE AZZURRA PER TRACCIATURA / PÓ AZUL PARA MARCAÇÃO



Ref					
0951 4357	100 g	1	6	3,20	✓
0951 4358	250 g	1	6	4,14	✓
0951 4390	500 g	1	6	5,71	✓
0951 4391	1000 g	1	6	9,51	✓

PLOMADA TRAZADORA / CORDEUR TRACEUR / CHALK LINE / LINEA DI GESSO / FIO MARCADOR



Gancho dentado.  
Crochet denté.  
Bent tips hook.  
Gancio dentato.  
Gancho dentado.



Permite extraer el cordel sin que gire la manilla.  
Permet au cordeau de sortir sans que la manivelle tourne.  
Crank will not spin when pulling out the line.  
Per estrarre la stringa senza girare la manovella.  
Permite extender o cordel sem girar a manivela.

Ref					
0951 4355	15 m	1	6	15,43	✓
0951 4356	30 m	1	6	15,90	✓

PLOMADA TRAZADORA POLIPROPILENO / FIL À PLOMB TRACEUR POLYPROPYLÈNE / POLYPROPYLENE CHALK LINE  
TRACCIATORE FILO DI PIOMBO IN POLIPROPILENO / FIO MARCADOR POLIPROPILENO



Ref					
0951 4359	30 m	1	6	12,17	✓

CORTA AZULEJOS MANUAL / COUPE CARREAUX MANUELS / HAND TILE CUTTERS / TABLIAPIASTRELLE / CORTADOR DE AZULEJOS MANUAL



Ref			
0951 4300	40 cm	1	125,25



Cuchilla recambio / Lame de rechange / Spare blade / Lama di ricambio / Lâmina de posição

Ref		
0951 4313	1	10,76

PALANCA ENCOFRADOR / PIED DE BICHE / CROW-BAR / PIEDE DI PORCO / ALAVANCA PÉ DE CABRA



Ref			
0951 7130	300 x 16 mm	1	6,86
0951 7131	400 x 16 mm	1	9,15
0951 7132	500 x 19 mm	1	11,49
0951 7133	600 x 19 mm	1	16,07
0951 7134	700 x 19 mm	1	19,50
0951 7135	750 x 19 mm	1	21,22
0951 7136	900 x 19 mm	1	25,84
0951 7137	1000 x 19 mm	1	28,13



LLANA RECTANGULAR / PLAT RECTANGULAIRE / RECTANGULAR TROWEL / FRATTONE LAMA RETTANGOLARE / PLANO RETANGULAR



ES Mango de madera.  
FR Poignée en bois.  
EN Wooden handle.  
IT Manico in legno.  
PT Pega de madeira.

Ref				
<b>0951 7030</b>	300x150x0,7 mm	1	6	<b>19,29</b>

LLANA MODELO RECTANGULAR MANGO PLÁSTICO / TRUELLE MOD. RECTANGULAIRE MANCHE PLASTIQUE  
RECTANGULAR TROWEL WITH PLASTIC HANDLE / FRATTAZZO MOD. RETTANGOLARE CON MANIGLIA IN PLASTICA  
TALOCHA MOD. RETANGULAR CABO PLÁSTICO



ES Mango de plástico.  
FR Poignée en plastique.  
EN Plastic handle.  
IT Manico in plastica.  
PT Pega de plástico.

Ref				
<b>0951 7193</b>	300x150x0,7 mm	1	6	<b>16,60</b>

LLANA DENTADA / PLAT DENTÉ / TROWEL WITH TEETH / FRATTONE LAMA DENTATA / PLANO DENTADO



8 x 8 mm

ES Mango de madera.  
FR Poignée en bois.  
EN Wooden handle.  
IT Manico in legno.  
PT Pega de madeira.

Ref				
<b>0951 7032</b>	300x150x0,7 mm	1	6	<b>20,64</b>

LLANA DENTADA MANGO PLÁSTICO / TRUELLE DENTÉE MANCHE PLASTIQUE / NOTCHED TROWEL WITH PLASTIC HANDLE  
FRATTAZZO DENTATO, MANIGLIA IN PLASTICA / TALOCHA DENTADA CABO PLÁSTICO



8 x 8 mm

ES Mango de plástico.  
FR Poignée en plastique.  
EN Plastic handle.  
IT Manico in plastica.  
PT Pega de plástico.

Ref				
<b>0951 7194</b>	300x150x0,7 mm	1	6	<b>17,50</b>

LLANA RASCADOR MONOCAPA / TRUELLE RACLETTE MONO COUCHE / RENDER SCRATCHING FLOAT FOR SINGLE COAT  
FRATTAZZO RASCHIATORE / TALOCHA PARA RASCAR MONOCAMADA

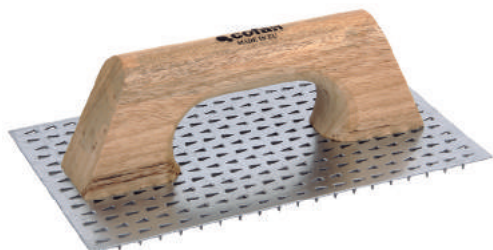

ES Mango de madera.  
FR Poignée en bois.  
EN Wooden handle.  
IT Manico in legno.  
PT Pega de madeira.

Ref				
<b>0951 7190</b>	250x150 mm	1	6	<b>20,07</b>



RASCADOR DE MONOCAPA / DÉCAPEUSE MONOCOUCHE / MONOCAPPA SCRAPER  
RASCHIATORE MONOSTRATO / RASCADOR DE CAPA ÚNICA



Ref				
<b>0951 7150</b>	250X150 mm	1	6	<b>18,72</b>

FRATÁS PLÁSTICO RECTÁNGULO / TRUELLE PLASTIQUE FORME RECTANGULAIRE / RECTANGLE PLASTIC TROWEL  
FRATTAZZO RETTANGOLARE IN PLASTICA / TALOCHA DE PLÁSTICO RETANGULAR



Ref			
<b>0951 7160</b>	270X180 mm	1	<b>6,40</b>
<b>0951 7161</b>	410X260 mm	1	<b>8,99</b>

FRATÁS PLÁSTICO PUNTA / TRUELLE PLASTIQUE EN POINTE / POINTED PLOASTIC TROWEL  
FRATTAZZO IN PLASTICA A PUNTA / TALOCHA DE PLÁSTICO EM BICO



Ref			
<b>0951 7163</b>	270X180 mm	1	<b>6,40</b>

LLANA PVC BLANCO EFECTO CHIRRIANTE / TRUELLEVE PVC BLANCHE, EFFET / WHITE PVC TROWEL, SCREECH EFFECT  
CAZZUOLA PVC BIANCA, EFFETTO / TALOCHA PVC BRANCO EFEITO ÁSPERO



Ref				
<b>0951 7187</b>	280x130x2,5 mm	1	6	<b>12,79</b>

LLANA PARA MICROCEMENTO / TRUELLE POUR MICROBÉTON / TROWEL FOR MICROCEMENT  
CAZZUOLA PER MICROCEMENTO / TALOCHA PARA MICROCIMENTO



Ref				
<b>0951 7188</b>	280x120x0,4 mm	1	6	<b>12,79</b>





LLANA VENECIANA INOX / TRUELLE VÉNITIENNE INOX / "VENECIANA" ST. STEEL / CAZZUOLA VENEZIANA INOX / TALOCHA VENEZIANA INOX

**INOX**



ES Pulido espejo.  
FR Poli miroir.  
EN Polished bricklayer.  
IT Lucido a specchio.  
PT Polida espelho.

Ref				
<b>0951 7169</b>	200 x 80 mm	1	6	<b>19,03</b>
<b>0951 7170</b>	240 x 100 mm	1	6	<b>21,53</b>
<b>0951 7171</b>	280 x 120 mm	1	6	<b>24,54</b>

LLANA VENECIANA INOX EXTRA-FLEXIBLE / TRUELLE VÉNITIENNE INOX EXTRA-FLEXIBLE / EXTRA-FLEXIBLE ST. STEEL TROWEL  
FRATTAZZO VENEZIANO INOX - SUPERFLESSIBILE / TALOCHA VENEZIANA INOX EXTRA-FLEXÍVEL



**EXTRA-FLEXIBLE**

Ref				
<b>0951 7182</b>	240x100x0,3 mm	1	6	<b>33,07</b>

LLANA EXTRA-FLEXIBLE INOX RECTANGULAR / TRUELLE EXTRA-FLEXIBLE INOX RECTANGULAIRE / EXTRA-FLEXIBLE, RECTANGULAR ST. STEEL TROWEL  
FRATTAZZO INOX SUPERFLESSIBILE RETTANGOLARE / TALOCHA EXTRA FLEXÍVEL INOX RETANGULAR



**EXTRA-FLEXIBLE**

Ref				
<b>0951 7183</b>	405x110x0,3 mm	1	6	<b>61,26</b>

LLANA EXTRA-LARGA PARA MICROCEMENTO / TRUELLE EXTRA LARGE POUR MICROBÉTON / EXTRA-LONG TROWEL FOR MICROCEMENT  
CAZZUOLA SUPERLUNGA PER MICROCEMENTE / TALOCHA EXTRA LONGA PARA MICROCEMENTO



Ref				
<b>0951 7189</b>	500x120x0,4 mm	1	6	<b>23,60</b>

FRATÁS DE ESPONJA DENSA / TRUELLE EN ÉPONGE DENSE / DENSE CELLS SPONGE TROWEL  
FRATTAZZO IN SPUGNA DENSA / TALOCHA COM ESPONJA DENSA

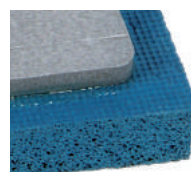

Ref				
<b>0951 7154</b>	210 x 130 mm	15 mm	1	12 <b>15,08</b>



FRATÁS DE ESPONJA GRUESA / TRUELLE EN ÉPONGE LOURDE / VERY DENSE CELLS SPONGE TROWEL  
FRATTAZZO IN SPUGNA A GRANA GROSSA / TALOCHA COM ESPONJA GROSSA



Ref					
<b>0951 7151</b>	210 x 130 mm	15 mm	1	12	<b>18,25</b>
<b>0951 7152</b>	240 x 100 mm	15 mm	1	12	<b>13,62</b>
<b>0951 7153</b>	280 x 140 mm	15 mm	1	12	<b>17,68</b>

FRATÁS DE GOMA RÍGIDA / TRUELLE CAOUTCHOUC RIGIDE / COARSE CELLS SPONGE TROWEL  
FRATTAZZO IN GOMMA RIGIDA / TALOCHA DE BORRACHA RÍGIDA

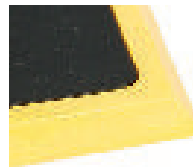

Ref					
<b>0951 7157</b>	250x110 mm	15 mm	1	6	<b>20,07</b>

LLANA ESPONJA PARA LIMPIAR AZULEJOS / TRUELLE ÉONGE DE NIVEAU POUR NETTOYER DES CARREAUX / SPONGE FLOAT FOR CLEANING TILES  
FRATTAZZO SPUGNA PER LA PULIZIA DELLE MATTONELLE / TALOCHA ESPONJA LIMPA AZULEJOS



Ref				
<b>0951 7191</b>	280x140x30 mm	1	6	<b>20,05</b>

RECAMBIO LLANA ESPONJA PARA LIMPIAR AZULEJOS / PIÈCE DE RECHANGE TRUELLE ÉPONGE DE NIVEAU NETTOYAGE CARREAUX  
SPARE SPONGE FLOAT FOR CLEANING TILES / RICAMBIO PER FRATTAZZO IN SPUGNA PER LA PULIZIA DELLE MATTONELLE  
REPOSIÇÃO ESPONJA TALOCHA LIMPA AZULEJOS



Ref				
<b>0951 7192</b>	280x140x30 mm	1	6	<b>11,90</b>



JUEGO DE ESPÁTULAS INOX / JEU DE SPATULES INOX / STAINLESS STEEL JAPANESE SET / SET SPATOLE INOX / JOGO DE ESPÁTULAS EM INOX



Ref	↔	📦	📦	📦
0951 7158	6, 8, 10, 12 cm	1	12	17,68

ESPÁTULA INOX LIMPIEZA LATAS PINTURA / SPATULE INOX LARGE NETTOYAGE PEINTURE / ST. STEEL SCRAPER FOR CLEANING PAINT CANS  
SPATOLA INOX PER PULIZIA PITTURA / ESPÁTULA INOX LIMPEZA LATAS TINTA



Ref	↔	📦	📦	📦
0951 7184	140 x 30 mm	1	12	27,72

ESPÁTULA INOX MEZCLA PINTURA / SPATULE INOX MÉLANGE PEINTURE / ST. STEEL TROWEL FOR MIXING PAINT  
SPATOLA INOX PER MISCELARE LA PITTURA / ESPÁTULA INOX MISTURA TINTA



Ref	↔	📦	📦	📦
0951 7185	190 mm	1	12	15,96

ESPÁTULA INOX PARA PINTURA / SPATULE INOX POUR PEINTURE / ST. STEEL TROWEL FOR PAINT  
SPATOLA INOX PER PITTURA / ESPÁTULA INOX PARA PINTURA



Ref	↔	📦	📦	📦
0951 7186	110 x 60 mm	1	12	33,26



ESPÁTULAS / SPATULES / SCRAPER / SPATOLE / ESPÁTULAS



Ref	↔	🏠	📦	📦
0951 7001	30 mm	1	12	4,11
0951 7002	40 mm	1	12	4,23
0951 7003	50 mm	1	12	4,50
0951 7004	60 mm	1	12	4,98
0951 7005	70 mm	1	12	5,32
0951 7006	80 mm	1	12	5,54
0951 7008	100 mm	1	12	6,85

ESPÁTULA INOX CON MANGO ABS / SPATULE INOX AVEC MANCHE ABS / ST. STEEL SCRAPER WITH ABS HANDLE  
SPATOLA INOX CON MANICO ABS / ESPÁTULA INOX COM CABO ABS

INOX



Ref	↔	🏠	📦	📦
0951 7175	40 mm	1	12	7,80
0951 7176	60 mm	1	12	8,83
0951 7177	80 mm	1	12	9,68
0951 7178	100 mm	1	12	10,74
0951 7179	120 mm	1	12	13,44
0951 7180	150 mm	1	12	16,12
0951 7181	200 mm	1	12	16,67

MOD. ARABIA



Ref	🏠	🏠	📦	📦
0951 5197	180 mm	1	6	15,29
0951 5198	200 mm	1	6	16,43

MANGO GOMA  
RUBBER HANDLE



Ref	↔	🏠	📦	📦
0951 5201	180 mm	1	6	12,43
0951 5202	200 mm	1	6	12,74

PALETÍN PUNTA AGUDA / TRUELLE PINTE FINE / SHARP TIP BRICKLAYERS / CAZZUOLINO PUNTA ACUTA / COLHER PONTA AGUDA



Ref	🏠	🏠	📦	📦
0951 7015	130 mm	1	6	11,34

MANGO GOMA  
RUBBER HANDLE



Ref	🏠	🏠	📦	📦
0951 5205	130 mm	1	6	10,82



MOD. SEVILLA



Ref					
0951 7025	180 mm	1	6		16,80

MANGO GOMA  
RUBBER HANDLE



Ref					
0951 5235	180 mm	1	6		13,42

MOD. PORTUGAL



Ref					
0951 7028	250x130 mm	1	6		17,58
0951 7029	220x120 mm	1	6		15,90

MANGO GOMA  
RUBBER HANDLE



Ref					
0951 5240	250x130 mm	1	6		16,12
0951 5241	220x120 mm	1	6		15,90

PUNTA CUADRADA / PINTE CARRÉE / SQUARE TIP / PUNTA QUADRA / PONTA QUADRADA



Ref					
0951 7027	260x130x65 mm	1	6		18,72

MANGO GOMA  
RUBBER HANDLE



Ref					
0951 5250	260x130x65 mm	1	6		18,35

PALETÍN ALICATADOR / TRUELLE DROIT / TILER BRICKLAYERS / CAZZUOLINO PIASTRELLISTA / COLHER LADRILHADOR



Ref					
0951 7026	125x125x65 mm	1	6		18,51

MANGO GOMA  
RUBBER HANDLE



Ref					
0951 5245	260x130x65 mm	1	6		17,58





PALETÍN PUNTA REDONDA / TRUELLE PINTE ARRONDIE / ROUND TIP BRICKLAYERS / CAZZUOLINO PUNTA ROTONDA / COLHER PONTA REDONDA



Ref					
0951 7016	130 mm	1	6		11,44

MANGO GOMA  
RUBBER HANDLE



Ref					
0951 5210	130 mm	1	6		10,76

MOD. NORTE



Ref					
0951 7017	180x130x110 mm	1	6		17,89
0951 7018	190x117x95 mm	1	6		17,89

MANGO GOMA  
RUBBER HANDLE



Ref					
0951 5220	180x130x110 mm	1	6		14,46
0951 5221	190x117x95 mm	1	6		14,46

MOD. MADRID



Ref					
0951 7021	140 mm	1	6		12,12
0951 7022	160 mm	1	6		12,90
0951 7023	180 mm	1	6		16,43
0951 7024	200 mm	1	6		17,99
0951 7033	230 mm	1	6		18,30

MANGO GOMA  
RUBBER HANDLE



Ref					
0951 5225	140 mm	1	6		11,23
0951 5226	160 mm	1	6		11,80
0951 5227	180 mm	1	6		13,31
0951 5228	200 mm	1	6		14,46
0951 5229	230 mm	1	6		14,82

MOD. CATALANA



Ref					
0951 7020	165 mm	1	6		18,20

MANGO GOMA  
RUBBER HANDLE



Ref					
0951 5215	165 mm	1	6		15,81



ES Palas para uso profesional, en acero. Su espesor de chapa así como su exclusivo proceso de tratamiento térmico en 3 fases les provee de la resistencia y elasticidad necesarias para las soleras de más altas exigencias. Su acabado superficial evita la adherencia de arena, tierra, etc. y facilita su mantenimiento.

FR Pelles et cosses pour un usage professionnel, fabriquées en acier. L'épaisseur ainsi bien que leur procédé exclusif du traitement thermique à 3 étapes leur fournissent une résistance et une élasticité nécessaires pour les sols les plus exigeants.

EN Shovels for professional use, made of steel. The thickness of them as well as their exclusive 3-step treatment process provide them with the necessary resistance and elasticity for the most demanding soils.

IT Pale per uso professionale, in acciaio. Lo spessore della lamiera, così come l'esclusivo processo di trattamento termico in 3 fasi, assicurano la resistenza e l'elasticità necessarie per l'uso più esigente. La finitura superficiale evita l'aderenza di fango e terra e ne facilita la manutenzione.

PT Pás para uso profissional, em aço. A sua espessura da chapa assim como o seu exclusivo processo de tratamento térmico em 3 fases faz com que sejam muito resistentes e flexíveis para as necessidades de trabalho mais exigentes. O acabamento na sua superfície evita a aderência de areia, terra etc., e facilita a sua manutenção.

PALA PICO PUÑO ABIERTO / PELLE PIOCHE MANCHE POIGNÉE OUVERTE / T-HANDLE PICK SHOVEL  
PALA PICCONE IMPUGNATURA APERTA / PÁ EM BICO PUNHO ABERTO



Ref	↔	A	B	📦	📦	📦
0951 7099	1020 mm	340 mm	290 mm	1	6	14,47

PALA PICO PUÑO CERRADO / PELLE PIOCHE MANCHE BOIS POIGNÉE FERMÉE / D-HANDLE PICK SHOVEL  
PALA PICCONE IMPUGNATURA CHIUSA / PÁ EM BICO PUNHO FECHADO



Ref	↔	A	B	📦	📦	📦
0951 7101	1020 mm	340 mm	290 mm	1	6	14,47

Válido para: / Valide pour: / Valid for: / Valido per: / Válido para:  
0951 7101 - 0951 7106 - 0951 7107

Ref	📦	📦	📦
0951 9445	1	6	9,54

PALA CUADRADA PUÑO ABIERTO / PELLE CARRÉE MANCHE POIGNÉE OUVERTE / T-HANDLE SQUARE SHOVEL  
PALA QUADRATA IMPUGNATURA APERTA / PÁ QUADRADA PUNHO ABERTO



Ref	↔	A	B	📦	📦	📦
0951 7104	1030 mm	340 mm	260 mm	1	6	14,47

PALA CUADRADA PUÑO CERRADO / PELLE CARRÉE MANCHE POIGNÉE FERMÉE / D-HANDLE SQUARE SHOVEL  
PALA QUADRATA IMPUGNATURA CHIUSA / PÁ QUADRADA PUNHO FECHADO



Ref	↔	A	B	📦	📦	📦
0951 7106	1030 mm	340 mm	260 mm	1	6	15,29



## PALA SIN PUÑO / PELLE PIOCHE MANCHE BOIS / SHOVEL / PALA SENZA IMPUGNATURA / PÁ SEM PUNHO



Pico / Pioche / Pick / Piccone / Em bico

Ref	↔	A	B		
0951 7103	1400 mm	325 mm	265 mm	1	25,72

Cuadrada / Carrée / Square / Quadrata / Quadrada

Ref	↔	A	B		
0951 7108	1400 mm	325 mm	265 mm	1	26,57
0951 7109	1400 mm	335 mm	285 mm	1	31,21

## PALA ALUMINIO / PELE ALUMINIUM / ALUMINIUM SHOVEL / PALA IN ALLUMINIO / PÁ EM ALUMÍNIO



Ref	↔	A	B		
0951 7110	1620 mm	345 mm	390 mm	1	59,86

PALOTE CUADRADO SIN PUÑO / PELLE CARRÉE MANCHE SANS POIGNÉE / SQUARE SHOVEL  
PALA QUADRATA SENZA IMPUGNATURA / PÁ QUADRADA SEM PUNHO

Ref	A	B		
0951 9335	280 mm	170 mm	1	30,89

MANGO / MANCHE / HANDLE / MANICO / PUNHO

Válido para: / Valide pour: / Valid for: / Valido per: / Válido para: 0951 9335

Ref		
0951 9449	1	6,17

## HACHA / HACHE / AXE / ASCIA / MACHADO

HACHA VIZCAÍNA MANGO MADERA / HACHE BISCAYENNE MANGUE BOIS / VIZCAINA AXE WOOD HANDLE  
ASCIA VIZCAINA MANICO IN LEGNO / MACHADO VISCAINA CABO MADEIRA

Ref	A			
0951 9221	380 mm	300 g	1	20,78
0951 9223	400 mm	500 g	1	24,20
0951 9226	450 mm	800 g	1	26,46
0951 9227	600 mm	1000 g	1	38,91
0951 9229	800 mm	1500 g	1	44,02
0951 9230	900 mm	2000 g	1	48,74
0951 9231	900 mm	2500 g	1	58,55
0951 9234	900 mm	3000 g	1	72,55

MANGO / MANCHE / HANDLE / MANICO / PUNHO

Ref	A			
0951 9421	380 mm	300 g	1	3,04
0951 9423	400 mm	500 g	1	3,47
0951 9426	450 mm	800 g	1	4,56
0951 9427	600 mm	1000 g	1	5,96
0951 9429	800 mm	1000 g	1	7,69
0951 9430	900 mm	2000 - 2500 - 3000 g	1	10,05

## HACHA DE MANO / HACHE MANUELLE / HANDLE AXE / ASCIA AD UNA MANO / MACHADINHA



Ref			
0951 5160	600 g	1	17,74
0951 5161	800 g	1	22,57
0951 5162	1000 g	1	27,05



AZADA 690-1 Y 690-2 / HOUE 690-1 ET 690-2 / HOE 690-1 AND 690-2 / ZAPPA 690-1 E 690-2 / ENXADA 690-1 E 690-2



Ref	A	B	Ø	ADAP	M		
<b>0951 9146</b>	270 mm	110 mm	44 mm	69-B	M2	1	<b>24,23</b>
<b>0951 9147</b>	310 mm	120 mm	44 mm	69-A	M2	1	<b>26,42</b>

AZADA 100-1, 100-2 Y 100-3 / HOUE 100-1, 100-2 Y 100-3 / HOE 100-1, 100-2 Y 100-3 / ZAPPA 100-1, 100-2 Y 100-3 / ENXADA 100-1, 100-2 Y 100-3



Ref	A	B	Ø	ADAP	M		
<b>0951 9111</b>	130 mm	80 mm	33 mm	1-A	M2	1	<b>12,34</b>
<b>0951 9112</b>	150 mm	90 mm	33 mm	1-B	M2	1	<b>14,09</b>
<b>0951 9113</b>	160 mm	105 mm	33 mm	1-C	M2	1	<b>15,41</b>

AZADILLA 2280-1 Y 2280-2 / HOUE 2280-1 Y 2280-2 / LITTLE HOE 2280-1 Y 2280-2 / ZAPETTA 2280-1 Y 2280-2 / SACHOLA 2280-1 Y 2280-2



Ref	A	B	Ø	ADAP	M		
<b>0951 9125</b>	270 mm	70 mm	33 mm	228-A	M2	1	<b>14,98</b>
<b>0951 9126</b>	300 mm	75 mm	33 mm	228-B	M2	1	<b>16,30</b>

AZADILLA 2320-1, 2320-2 Y 2320-3 / HOUE 2320-1, 2320-2 Y 2320-3 / LITTLE HOE 2320-1, 2320-2 Y 2320-3 / APPETA 2320-1, 2320-2 Y 2320-3 / SACHOLA 2320-1, 2320-2 Y 2320-3



Ref	A	B	Ø	ADAP	M		
<b>0951 9131</b>	110 mm	70 mm	33 mm	232-A	M2	1	<b>12,33</b>
<b>0951 9132</b>	120 mm	75 mm	33 mm	232-B	M2	1	<b>13,66</b>
<b>0951 9133</b>	130 mm	90 mm	33 mm	232-C	M2	1	<b>14,98</b>

AZADA 1820 / HOUE 1820 / HOE 1820 / ZAPPA 1820 / ENXADA 1820



Ref	A	B	Ø	ADAP	M		
<b>0951 9155</b>	150 mm	50 mm	33 mm	182	M2	1	<b>16,84</b>



AZADA 200-1 Y 200-2 / AZADA 200-1 Y 200-2 / AZADA 200-1 Y 200-2 / AZADA 200-1 Y 200-2 / ENXADA 200-1 Y 200-2

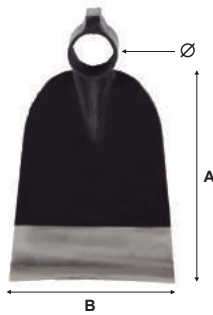

Ref	A	B	Ø	ADAP	M		
<b>0951 9115</b>	180 mm	140 mm	38 mm	2-A	M3	1	<b>18,50</b>
<b>0951 9116</b>	195 mm	145 mm	38 mm	2-B	M3	1	<b>19,82</b>

AZADA 400-1 Y 400-2 / HOUE 400-1 Y 400-2 / HOE 400-1 Y 400-2 / ZAPPA 400-1 Y 400-2 / ENXADA 400-1 Y 400-2



Ref	A	B	Ø	ADAP	M		
<b>0951 9117</b>	200 mm	165 mm	38 mm	4-A	M3	1	<b>21,58</b>
<b>0951 9118</b>	210 mm	190 mm	38 mm	4-B	M3	1	<b>22,90</b>

AZADA 3200 / HOUE 3200 / HOE 3200 / ZAPPA 3200 / ENXADA 3200



Ref	A	B	Ø	ADAP	M		
<b>0951 9119</b>	220 mm	190 mm	38 mm	320	M3	1	<b>22,90</b>

AZADA 530-1 Y 530-2 / HOUE 530-1 Y 530-2 / HOE 530-1 Y 530-2 / ZAPPA 530-1 Y 530-2 / ENXADA 530-1 Y 530-2



Ref	A	B	Ø	ADAP	M		
<b>0951 9120</b>	225 mm	75 mm	38 mm	53-A	M3	1	<b>21,80</b>
<b>0951 9121</b>	245 mm	85 mm	38 mm	53-B	M3	1	<b>23,34</b>

AZADA PUNTA REDONDA N°0, 1, 1 ½, 2, 2 ½, 3 / HOUE POINTE RONDE N°0, 1, 1 ½, 2, 2 ½, 3 / HOE NO.0, 1, 1 ½, 2, 2 ½, 3 ROUND POINT  
ZAPPA PUNTA ROTONDA N°0, 1, 1 ½, 2, 2 ½, 3 / ENXADA PONTA REDONDA N°0, 1, 1 ½, 2, 2 ½, 3

Ref	A	Ø	ADAP	M		
<b>0951 9136</b>	175 mm	33 mm	72-0	M2	1	<b>18,69</b>
<b>0951 9137</b>	200 mm	38 mm	72-1	M3	1	<b>19,82</b>
<b>0951 9140</b>	225 mm	38 mm	72-A 1,5L	M3	1	<b>21,80</b>
<b>0951 9141</b>	240 mm	38 mm	72-B 2L	M3	1	<b>24,44</b>
<b>0951 9142</b>	260 mm	38 mm	72-C 2,5L	M3	1	<b>27,09</b>
<b>0951 9143</b>	295 mm	38 mm	72-D 3L	M3	1	<b>29,17</b>





AZADA PUNTA N° 2 / HOUE POINTE N°2 / HOE NO.2 POINT / ZAPPA PUNTA N°2 / ENXADA PONTA N°2

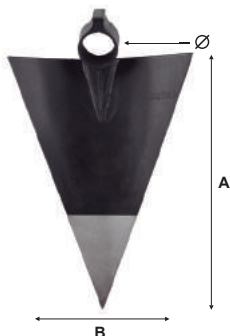

Ref	A	Ø	ADAP	M		
<b>0951 9150</b>	270 mm	38 mm	150-A	M3	1	<b>19,26</b>

AZADA MODELO 81 / HOUE COFAN 81 / HOE 81 / ZAPPA COFAN 81 / ENXADA COFAN 81

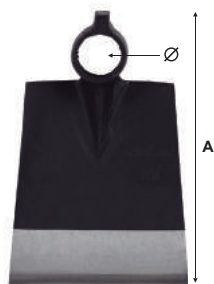

Ref	S	A	Ø	M		
<b>0951 9160</b>	000	185	33 mm	M2	1	<b>14,82</b>
<b>0951 9161</b>	00	195	33 mm	M2	1	<b>16,10</b>
<b>0951 9162</b>	0	205	33 mm	M2	1	<b>18,13</b>
<b>0951 9163</b>	1	220	38 mm	M3	1	<b>19,08</b>
<b>0951 9164</b>	1,5	235	38 mm	M3	1	<b>19,82</b>
<b>0951 9165</b>	2	250	38 mm	M3	1	<b>20,88</b>
<b>0951 9166</b>	2,5	255	38 mm	M3	1	<b>21,73</b>
<b>0951 9167</b>	3	265	38 mm	M3	1	<b>22,58</b>

RASTRILLO DIENTES PIEDRA / RATEAU DENTS PIERRE / STONE TEETH RAKE / RASTRELLO DENTI IN PIETRA / ANCINHO DENTES PEDRA

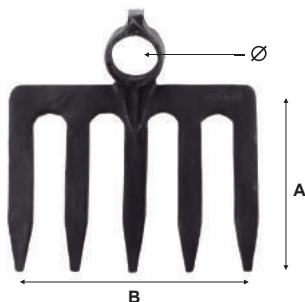

Ref	A	B		Ø	ADAP	M		
<b>0951 9381</b>	165 mm	200 mm	5	44 mm	5753-B	M4	1	<b>21,62</b>

AZADÓN 8010-0 / HOUE 8010-0 / MATTOCK 8010-0 / ZAPPETA 8010-0 / CAVADOR 8010-0



Ref	A	B	Ø	ADAP	M		
<b>0951 9134</b>	265 mm	75 mm	50 mm	801-0	M7	1	<b>45,35</b>

RAEDERA / RACLOIR / HOE / RASCHIETTO / RASPADOR



Ref	A	B	Ø	ADAP	M			
<b>0951 9397</b>	160 mm	260 mm	29 mm	5701-0	M1	1000 g	1	<b>24,34</b>



## RASTRILLO FORJADO / RATEAU FORGÉ / FORGED RAKE / RASTRELLO FORGIATO / ANCINHO FORJADO



Ref	A	B	Ø	▲▲▲	M		
0951 9352	178 mm	100 mm	29 mm	6	M-952	1	12,72
0951 9353	245 mm	100 mm	29 mm	8	M-952	1	13,66
0951 9354	305 mm	100 mm	29 mm	10	M-952	1	14,78
0951 9355	375 mm	100 mm	29 mm	12	M-952	1	16,09
0951 9356	435 mm	100 mm	29 mm	14	M-952	1	17,40
0951 9357	500 mm	100 mm	29 mm	16	M-952	1	18,90
0951 9358	565 mm	100 mm	29 mm	18	M-952	1	20,96

## ZACHO RECTO / SERFOUETTE DROITE / STRAIGHT LITTLE HOE / ZAPPA DOPPIA DRITTA / SACHO RETO 1 PONTA



Ref	A	B	▲▲▲	Ø	M		
0951 9371	80 mm	230 mm	1	26 mm	M1	1	10,29
0951 9372	80 mm	230 mm	2	26 mm	M1	1	10,87
0951 9373	80 mm	230 mm	3	26 mm	M1	1	11,61

## MANGO GUADAÑA / MANCHE FAUX COFAN / SCYTHE HANDLE / MANICO FALCE COFAN / CABO P/ GADANHA COFAN

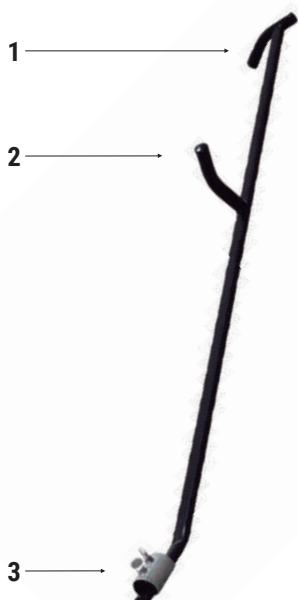

1 Mango.  
Manche.  
Handle.  
Manico.  
Cabo.



2 Mango.  
Manche.  
Handle.  
Manico.  
Cabo.



3 Fijación para cuchilla.  
Fixation pour lame.  
Blade fastening.  
Fissaggio per lama.  
Fixação para lâmina.

Ref		
0951 9388	1	25,00



HORCAS MANGO METAL / FOURCHE MANCHE MÉTAL / PITCHFORKS WITH METAL HANDLE  
FORCHE CON MANICO IN METALLO / FORQUILHA CABO METAL

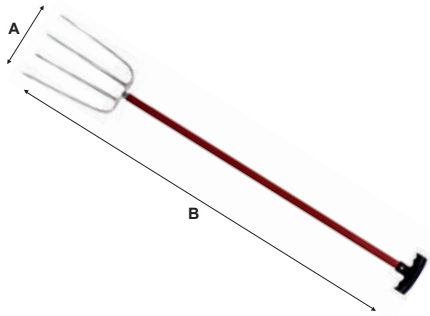

Ref	A	B	▲▲▲	📦	📊
0951 9331	230 mm	1450 mm	4	1	29,07
0951 9332	260 mm	1450 mm	5	1	30,87
0951 9333	280 mm	1450 mm	6	1	32,59

HORCAS / FOURCHES / PITCHFORKS / FORCHE / FORQUILHAS

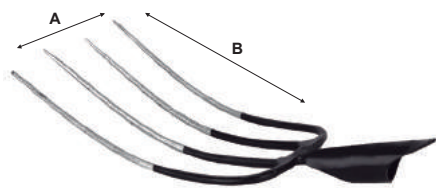

Ref	A	B	▲▲▲	∅	M	📦	📊
0951 9311	230 mm	320 mm	4	31 mm	M-901	1	22,01
0951 9312	260 mm	320 mm	5	31 mm	M-901	1	22,89
0951 9313	280 mm	320 mm	6	31 mm	M-901	1	24,66

GARABATOS / FOURCHE A GRIFFES / CURVED PITCHFORKS / FORCHE CURVE / FORQUILHA CURVA

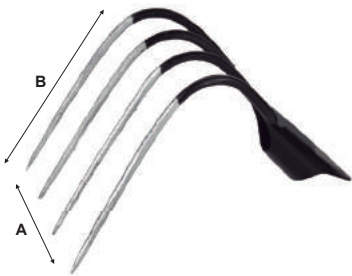

Ref	A	B	▲▲▲	∅	M	📦	📊
0951 9321	230 mm	300 mm	4	31 mm	M-901	1	22,89
0951 9322	260 mm	300 mm	5	31 mm	M-901	1	24,23

MANGOS / MANCHES / HANDLES / MANICI / PUNHO



Ref	↔	∅	M	📦	📊
0951 9458	390 mm	26 mm	M1	1	1,73
0951 9400	1000 mm	33 mm	M2	1	3,40
0951 9402	1200 mm	33 mm	M2	1	4,13
0951 9405	1000 mm	38 mm	M3	1	3,98
0951 9407	1200 mm	38 mm	M3	1	4,79
0951 9410	1000 mm	42 - 44 mm	M4	1	4,84
0951 9412	1200 mm	42 - 44 mm	M4	1	5,55
0951 9447	900 mm	50 mm	M7	1	5,81
0951 9452	1200 mm	29 mm	M-952	1	4,07
0951 9454	1400 mm	29 mm	M-952	1	4,89

MANGO HORCAS Y GARABATOS / MANCHES FOURCHES ET GRIFFES / HANDLES FOR PITCHFORKS AND CURVED PITCHFORKS  
MANICO FORCHE E FORCHE CURVE / CABOS FORQUILHAS E FORQUILHA CURVA



Ref	↔	∅	M	📦	📊
0951 9441	1200 mm	29x36x39 mm	M-901	1	5,55
0951 9442	1400 mm	29x36x39 mm	M-901	1	6,47



**CAVAHOYOS DE ACERO / CREUSE-TROUS ACIER / STEEL POST HOLE DIGGERS  
SCAVABUCHI IN ACCIAIO / CAVADEIRA DE AÇO**

CUÑA METAL LEÑA / POINTE MÉTAL BOIS / METAL WEDGE/FIREWOOD / CUNEO IN METALLO/LEGNO / CUNHA METAL LENHA



Ref	↔	📏	📦	📦	📦
<b>0951 9361</b>	180 mm	1000 g	1	1	<b>8,45</b>
<b>0951 9362</b>	195 mm	1500 g	1	1	<b>11,11</b>
<b>0951 9363</b>	210 mm	2000 g	1	1	<b>14,82</b>
<b>0951 9364</b>	230 mm	2500 g	1	1	<b>18,95</b>
<b>0951 9365</b>	245 mm	3000 g	1	1	<b>23,23</b>

CAVAHOYOS DE ACERO / CREUSE-TROUS ACIER / STEEL POST HOLE DIGGERS / SCAVABUCHI IN ACCIAIO / CAVADEIRA DE AÇO



Ref	📏	📦	📦	📦
<b>0951 9339</b>	1500 x 160 mm	1	1	<b>48,46</b>

**CINCELES Y CORTAFRÍOS / BURINS ET CISEAUX DE MACONS / COLD CHISELS & CHISELS  
SCALPELLI E TAGLIA-GHIACCIO / CINZÉIS E CORTA-FRIOS**

CORTAFRÍOS / BURINS / COLD CHISEL / TAGLIA GHIACCIO / CORTA-FRIOS



Ref	📏	📏	📦	📦	📦
<b>0951 7034</b>	15 x 125 mm		1	6	<b>9,23</b>
<b>0951 7035</b>	21 x 200 mm		1	6	<b>9,94</b>
<b>0951 7036</b>	22 x 200 mm		1	6	<b>11,87</b>

CINCEL CHAPISTA / BURIN DE CARROSSIER / EXTRA FLAT COLD CHISEL / SCALPELLO / CINZEL CHAPISTA



Ref	📏	📏	📦	📦	📏	📦
<b>0951 7037</b>	20 x 200 mm		1	6	245 g	<b>16,62</b>



CINCEL HEXAGONAL / CISEAUX DE MAÇON HEXAGONAL / CHISEL HEXAGONAL / SCALPELLO ESAGONALE / CINZEL HEXAGONAL



Ref	↔	A	B	📦	📦	📦
<b>0951 7038</b>	200 mm	23 mm	16 mm	1	6	<b>11,15</b>
<b>0951 7040</b>	300 mm	24 mm	16 mm	1	6	<b>12,67</b>
<b>0951 7041</b>	300 mm	25 mm	18 mm	1	6	<b>13,80</b>
<b>0951 7042</b>	350 mm	26 mm	18 mm	1	6	<b>14,99</b>
<b>0951 7044</b>	400 mm	27 mm	20 mm	1	6	<b>17,86</b>
<b>0951 7045</b>	500 mm	28 mm	20 mm	1	6	<b>20,17</b>

CON MANGO / AVEC MANCHE / WITH HANDLE / CON MANICO / COM PUNHO



Ref	↔	A	B	📦	📦	📦
<b>0951 7046</b>	200 mm	23 mm	16 mm	1	6	<b>16,01</b>
<b>0951 7048</b>	300 mm	24 mm	16 mm	1	6	<b>17,50</b>
<b>0951 7049</b>	300 mm	25 mm	18 mm	1	6	<b>18,67</b>
<b>0951 7050</b>	350 mm	26 mm	18 mm	1	6	<b>19,79</b>
<b>0951 7052</b>	400 mm	27 mm	20 mm	1	6	<b>22,83</b>
<b>0951 7053</b>	500 mm	28 mm	20 mm	1	6	<b>24,98</b>

PUNTERO / POINÇON / CENTRE PUNCH / PUNZONE / PONTEIRO



Ref	📦	📦	📦	📦
<b>0951 7054</b>	16 x 200 mm	1	6	<b>8,90</b>
<b>0951 7056</b>	16 x 300 mm	1	6	<b>10,42</b>
<b>0951 7058</b>	18 x 350 mm	1	6	<b>13,76</b>
<b>0951 7059</b>	18 x 400 mm	1	6	<b>14,19</b>
<b>0951 7061</b>	20 x 500 mm	1	6	<b>14,92</b>

CON MANGO / AVEC MANCHE / WITH HANDLE / CON MANICO / COM PUNHO



Ref	📦	📦	📦	📦
<b>0951 7062</b>	16 x 200 mm	1	6	<b>11,63</b>
<b>0951 7064</b>	16 x 300 mm	1	6	<b>12,67</b>
<b>0951 7066</b>	18 x 350 mm	1	6	<b>15,69</b>
<b>0951 7067</b>	18 x 400 mm	1	6	<b>16,09</b>
<b>0951 7069</b>	20 x 500 mm	1	6	<b>18,67</b>

CINCEL PARA LADRILLOS / CISEAUX A BRIQUES / BOLSTER CHISEL / SCALPELLO PER MATTONI / CINZEL PARA LADRILHOS



Ref	📦	📦	📦	📦
<b>0951 7070</b>	60 x 220 mm	1	6	<b>19,51</b>
<b>0951 7071</b>	75 x 240 mm	1	6	<b>20,34</b>

CON MANGO / AVEC MANCHE / WITH HANDLE / CON MANICO / COM PUNHO

Ref	📦	📦	📦	📦
<b>0951 7072</b>	60 x 220 mm	1	6	<b>22,91</b>
<b>0951 7073</b>	75 x 240 mm	1	6	<b>24,18</b>





NIVEL TRAPEZOIDAL PROFESIONAL / NIVEAU TRAPÉZOÏDAL PROFESSIONNEL / PROFESSIONAL BRIDGE SPIRIT LEVEL  
LIVELLA TRAPEZOIDALE PROFESSIONALE / NÍVEL TRAPEZÓIDE PROFISSIONAL



Ref	↔	📦	📊
0951 7201	400 mm	1	14,56
0951 7202	600 mm	1	19,04

NIVEL MAGNÉTICO ALUMINIO / NIVEAU MAGNÉTIQUE ALUMINIUM / ALUMINIUM MAGNETIC SPIRIT LEVEL  
LIVELLA MAGNETICA IN ALLUMINIO / NÍVEL MAGNÉTICO ALUMÍNIO



Ref	↔	📦	📊
0951 7205	300 mm	1	14,15
0951 7206	400 mm	1	15,64
0951 7207	500 mm	1	17,57
0951 7208	600 mm	1	18,82
0951 7209	800 mm	1	20,99
0951 7210	1000 mm	1	26,96
0951 7211	1200 mm	1	30,33
0951 7212	1500 mm	1	35,24

NIVEL ALUMINIO PROFESIONAL / NIVEAU ALUMINIUM PROFESSIONNEL / PROFESSIONAL ALUMINIUM SPIRIT LEVEL  
LIVELLA PROFESSIONALE IN ALLUMINIO / NÍVEL ALUMÍNIO PROFISSIONAL



Ref	↔	📦	📊
0951 7221	400 mm	1	14,06
0951 7222	500 mm	1	15,84
0951 7223	600 mm	1	16,94

NIVEL ALUMINIO HEAVY DUTY PROFES. / NIVEAU ALUMINIUM HEAVY DUTY PROFES. PROFESSIONAL / ALUMINIUM SPIRIT LEVEL HEAVY DUTY  
LIVELLA IN ALLUMINIO HEAVY DUTY PROFESS. / NÍVEL ALUMÍNIO HEAVY DUTY PROFES.



Ref	↔	📦	📊
0951 7230	500 mm	1	30,18



NIVEL MAGNÉTICO ALUM. MOD. TORPEDO / NIVEAU MAGNÉTIQUE ALUM. MOD. TORPEDO / ALUMINIUM MAGNETIC SPIRIT LEVEL TORPEDO MODEL  
LIVELLA MAGNETICA IN ALLUM. MOD. TORPEDO / NÍVEL MAGNÉTICO ALUM. MOD. TORPEDO



ES Burbujas en acrílico duraderas, de lectura vertical, horizontal y 45°. Marco sólido de aluminio. Práctico visor superior para facilitar la lectura. Ranura en V para trabajos con tubos. Magnético.

FR Bulles en acrylique durables pour lecture verticale, horizontale et à 45°. Cadre solide en aluminium. Viseur supérieur pratique pour faciliter la lecture. Cannelure en V pour travaux avec tubes. Aimants.

EN Long-lasting acrylic vials read plumb, horizontal and 45°. Solid aluminium frame. Convenient top reading window. V-grooved for pipe works. Magnetics.

IT Bolle in acrilico resistente a lettura verticale, orizzontale e 45°. Struttura solida in alluminio. Pratico display superiore per facilitarne la lettura. Fessura a V per lavori con tubi. Magneti.

PT Bolhas em acrílico duráveis de leitura vertical, horizontal e 45°. Estrutura sólida em alumínio. Visor superior prático para facilitar a leitura. Ranhura em V para trabalhos com tubos. Ímãs.

Ref	↔	📦	📊
<b>0951 7240</b>	250 mm	1	<b>13,14</b>

PIE DE REY FRACCIONARIO DIGITAL INOX / PIEDS À COULISSE FRACTIONNÉ NUMÉRIQUE / DIGITAL FRACTIONAL CALIPERS  
CALIBRO DIGITALE FRAZIONARIO / CALIBRADOR FRACTIONÁRIO DIGITAL EM INOX

Exactitud / Exactitude / Accuracy / Accuratezza / Exatidão: +/- 0.004"/+/- 0.02mm

Resolución / Résolution / Resolution / Risoluzione / Resoluçã: 0.0005", 0.01, 1/64"

Incluye / Inclus / Includes / Comprende / Inclui: 1"SR44" (1.5V) battery

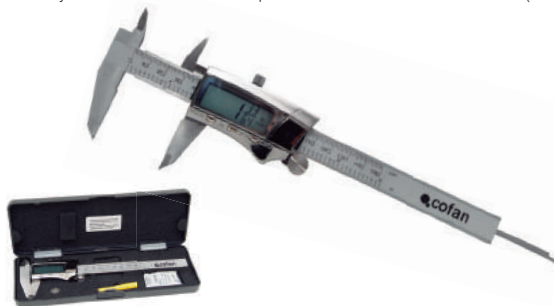

ES Acero inoxidable. Pie de Rey o Calibre fraccionario digital. Construcción en acero inoxidable (heavy duty). Característica de Auto Apagado. Display digital en tres modalidades: Pulgadas, Fracciones, Métrico. Incluye 1"SR44" (1.5V) batería.

FR Acier inoxydable. Pieds à coulisse fractionné numérique. Construction en Acier inoxydable (équipement lourd). Fonction Arrêt automatique. Ecran Numérique en trois modes: Pouces, Fractions, Métrique. Inclus 1"SR44" (1.5V) battery.

EN Stainless steel. Digital Fractional Calipers. Heavy Duty Stainless Steel Construction. Convenient Auto Off Feature. Three Mode Digital Display: Decimal Inches, Fractions, Metric. Includes 1"SR44" (1.5V) battery.

IT Acciaio inossidabile. Calibro digitale frazionario. Fabricato in acciaio inossidabile (per lavori gravosi). Spegnimento automatico. Display digitale a 3 modalità: Pollici, frazioni, metrica. Comprende 1"SR44" (1.5V) battery.

PT Aço inoxidável. Calibre digital fraccionário. Construção em aço inoxidável (pesados). Característica de auto desligamento. Display digital em três modos: polegadas, frações, métricas. Inclui bateria 1 "SR44" (1.5V).

Ref	📦	📦	📊
<b>0994 0004</b>	0-160 mm	1	<b>92,82</b>

PIE DE REY DE PRECISIÓN VERNIER INOX / PIEDS À COULISSE DE PRÉCISION VERNIER / PRECISION VERNIER CALIPERS  
CALIBRO DI PRECISIONE VERNIER / CALIBRADOR DE PRECISÃO VERNIER EM INOX



ES Medidas en mm y en pulgadas. Construcción en acero inoxidable endurecido.

FR Mesures en mm et en pouces. Construction en acier inoxydable renforcé.

EN Measures both in mm & inches. Hardened Stainless Steel Construction.

IT Misure in mm e in pollici. Fabricato in acciaio inossidabile indurito.

PT Medidas em mm e polegadas. Fabricado em aço inoxidável reforçado.

Ref	📦	📦	📊
<b>0994 0001</b>	0-150 mm	1	<b>59,75</b>
<b>0994 0003</b>	0-200 mm	1	<b>110,35</b>

PIE DE REY DE LATÓN / PIEDS À COULISSE / BRASS CALIPERS / CALIBRO IN ATTONE / CALIBRADOR DE LATAO



Ref	📦	📦	📊
<b>0994 0005</b>	0-75 mm	1	<b>8,37</b>
<b>0994 0006</b>	0-100 mm	1	<b>9,37</b>



FLEXÓMETRO / MÈTRE / MEASURING TAPE / METRO FLESSIBILE / FITA MÉTRICA



Ref	↔	▬	▧	📦	📊	📌
1052 3016	3 m	16 mm	1	12	2,97	✓
1052 5019	5 m	19 mm	1	12	4,24	✓
1052 5025	5 m	25 mm	1	6	5,25	✓
1052 8025	8 m	25 mm	1	6	7,50	✓

ES Carcasa protegida en goma. Carcasas antichoque de duración ilimitada. Muelle de retorno extrafuerte. Graduación continua y de fácil visión. Uñas reforzadas antichoque para trabajos exigentes. Doble acción de bloqueo y freno.

FR Structure protectrice en caoutchouc. Structure antichoc pour durée illimitée. Ressort de retour extrafort. Graduation continue et très claire pour une meilleure visibilité. Crochets renforcés antichoc pour travail exigeant. Double action de blocage et de freinage.

EN Easy grip protective rubber jacket. Unlimited life antishock cases. Extraresistant returning spring. Continuous and easy-reading scale. Antishock reinforced hooks. Blocking and braking double action.

IT Carcassa protetta in gomma. Carcassa antishock di durata illimitata. Robusta molla di ritorno. Graduazione continua e di facile lettura. Uncino rinforzato anticaduta per i lavori più esigenti. Doppia azione di blocco e freno.

PT Carcaça protegida com borracha, anti-choque de duração ilimitada, mola de retorno extra-forte. Graduação contínua e de fácil visão. Ganchos reforçados anti-choque para trabalhos exigentes. Dupla ação do bloqueio e do travão.

FLEXÓMETRO RECUBIERTO DE GOMA / MÈTRE PROTEC. CAOUTCHOUC / RUBBER MEASURING TAPE  
FLESSIBILE RICOPERTO IN GOMMA / FITA MÉTRICA REVESTIDA DE BORRACHA



Ref	↔	▬	▧	📦	📊	📌
1050 3016	3 m	16 mm	1	12	3,34	✓
1050 3019	3 m	19 mm	1	12	3,71	✓
1050 5019	5 m	19 mm	1	12	4,70	✓
1050 5025	5 m	25 mm	1	6	5,85	✓
1050 8025	8 m	25 mm	1	6	8,70	✓
1050 10032	10 m	32 mm	1	6	13,95	✓

FLEXÓMETRO GANCHO MAGNÉTICO / MÈTRE MAGNETIQUE / MAGNETIC MEASURING TAPE  
METRO FLESSIBILE CON GANCIO MAGNETICO / FITA MÉTRICA COM GANCHO MAGNÉTICO



Punta magnética con imanes / Pointe magnétique avec aimant / Magnetic point  
Punta magnetica con magneti / Ponta magnética com ímãs

Ref	↔	▬	▧	📦	📊	📌
1053 3016	3 m	16 mm	1	12	4,19	✓
1053 5019	5 m	19 mm	1	6	6,05	✓
1053 8025	8 m	25 mm	1	6	9,85	✓

FLEXÓMETRO ANTIDESLIZANTE / MÈTRE ANTIDÉRAPANT / NONSLIP MEASURING TAPE  
METRO FLESSIBILE ANTISCIVOLO / FITA MÉTRICA ANTI-DESILIZANTE



Ref	↔	▬	▧	📦	📊	📌
1051 3016	3 m	16 mm	1	12	3,48	✓
1051 5019	5 m	19 mm	1	12	5,04	✓
1051 8025	8 m	25 mm	1	6	8,75	✓



FLEXÓMETRO SÚPER IMÁN Y LED / METRE AIMANTE SUPER ET LED / MAGNETIC MEASURING TAPE WITH LED  
METRO FLESSIBILE SUPER MAGNETICO E CON LED / FLEXOMETRO SUPER ÍMÃ E LED



Ref	↔	▬	▧	📦	📊	🛒
1049 3019	3 m	19 mm	1	6	10,49	✓
1049 5019	5 m	19 mm	1	6	11,98	✓
1049 8025	8 m	25 mm	1	6	18,18	✓

FLEXÓMETRO METAL + MOSQUETÓN / METRE MÉTAL + MOUSQUETON / METAL MEASURING TAPE + HOOK  
METRO FLESSIBILE IN METALLO + MOSCHETTONE / FLEXOMETRO METAL + MOSQUETÃO

Bricofan



Ref	↔	▬	▧	📦	📊
1052 2010	2 m	10 mm	1	24	3,82

EXPOSITOR FLEXÓMETROS / PRÉSENTOIR MÈTRES / MEASURING TAPE EXHIBITOR / ESPOSITORE METRI / EXPOSITOR PARA FITAS MÉTRICAS



Ref	▧	📦	📊
1050 9999	72 uds	1	495,65

CONTENIDO / CONTENT

Ref	↓	▧
1050 3019	Flexómetro Protección goma 19mm x 3 m	6
1050 5019	Flexómetro Protección goma 19mm x 5 m	6
1050 8025	Flexómetro Protección goma 25mm x 8 m	6
1050 3016	Flexómetro Antideslizante 16mm x 3 m	6
1050 5019	Flexómetro Antideslizante 19mm x 5 m	6
1050 8025	Flexómetro Antideslizante 25mm x 8 m	6
1052 3016	Flexómetro Standard 16mm x 3 m	6
1052 5019	Flexómetro Standard 19mm x 5 m	6
1052 8025	Flexómetro Standard 25mm x 8 m	6
1053 3016	Flexómetro Magnético 16mm x 3 m	6
1053 5019	Flexómetro Magnético 19mm x 5 m	6
1053 8025	Flexómetro Magnético 25mm x 8 m	6
Expositor 5	Expositor vertical 430 x 800 mm	1





**CINTA MÉTRICA DE ACERO RECUBIERTA DE NYLON / RUBAN MÉTRIQUE ACIER RECUBR. NYLON / STEEL TAPE MEASURE NYLON COATING  
NASTRO METRICO IN ACCIAIO CON RIVESTIMENTO IN NYLON / FITA MÉTRICA AÇO RECUBR. NYLON**



ES Piezas metálicas protegidas para una mayor durabilidad de la cinta. Cinta métrica de acero con caja fabricada en ABS y recubierta de goma negra. Punta magnética. Sistema de recogida de cinta al triple de velocidad.

FR Pièces métalliques protégées pour une plus grande durabilité. Mètre ruban en acier avec boîtier en ABS et recouvert de caoutchouc noir. Pointe magnétique. Système de retour du mètre ruban trois fois plus rapide.

EN Protected metal pieces for greater durability. Long steel measure tape with ABS case coated with black rubber. Magnetic hook. Taking back the blade with 3 times speed.

IT Componenti metalliche per una maggiore durata. Metro in acciaio con struttura fabbricata in ABS e rivestita in gomma nera. Punta magnetica. Sistema di raccolta del nastro a tripla velocità.

PT Peças metálicas protegidas para maior durabilidade. Fita métrica de aço com caixa fabricada em ABS e coberta de borracha preta. Ponta magnética. Sistema de correias transportadoras de velocidade tripla.

Ref	↔	↕	📦	📦
<b>1056 1230</b>	30 m	13 mm	1	<b>31,75</b>
<b>1056 1250</b>	50 m	13 mm	1	<b>46,16</b>

**CINTA MÉTRICA FIBRA DE VIDRIO/ABS / DECAMETRE A RUBAN FIBRE DE VERRE/ABS / FIBREGLASS/ABS TAPE MEASURE  
NASTRO METRICA FIBRA VETRO/ABS / FITA MÉTRICA FIBRA VIDRO/ABS**



ES Cinta métrica de fibra de vidrio impermeable de alta calidad. Cinta métrica de acero con caja fabricada en ABS y recubierta de goma negra. Caja de ABS de alta resistencia a los impactos con goma TPR. Escala de gran precisión y exactitud.

FR Ruban en fibre de verre imperméable de haute qualité. Mètre ruban en acier avec boîtier en ABS et recouvert de caoutchouc noir. Boîtier en ABS de haute résistance aux impacts avec caoutchouc TPR. Échelle de grande précision et d'exactitude.

EN Superior waterproof fiberglass tape measure. Long steel measure tape with ABS case coated with black rubber. High strength and shock-resistant ABS case with TPR rubber. High precision scale for higher accuracy.

IT Nastro in fibra di vetro impermeabile di alta qualità. Metro in acciaio con struttura fabbricata in ABS e rivestita in gomma nera. Struttura in ABS ad alta resistenza all'impatto, con gomma TPR. Scala di gran precisione e accuratezza.

PT Fita de fibra de vidro impermeável de alta qualidade. Fita métrica de aço com caixa fabricada em ABS e coberta de borracha preta. Caixa de ABS de alta resistência a impactos com borracha TPR. Escala de grande precisão e exatidão.

Ref	↔	↕	📦	📦
<b>1056 1120</b>	20 m	13 mm	1	<b>15,74</b>
<b>1056 1130</b>	30 m	13 mm	1	<b>22,68</b>
<b>1056 1150</b>	50 m	13 mm	1	<b>31,27</b>

**CINTA MÉTRICA FIBRA DE VIDRIO CON MANGO / RUBANS METRIQUE FIBRE DE VERRE AVEC MANCHE / FIBER GLASS TAPE WITH HANDLE  
BANDA METRICA IN FIBRA DI VETRO CON MANICO / FITA METRICA EM FIBRA DE VIDRO COM CABO**



Ref	↔	↕	📦	📦
<b>1055 0030</b>	30 m	13 mm	1	<b>15,53</b>
<b>1055 0050</b>	50 m	13 mm	1	<b>21,47</b>





ESCUADRA PRECISIÓN ACERO / EQUERRE DE PRÉCISION ACIER / PRECISION STEEL SQUARE  
SQUADRA DI PRECISIONE IN ACCIAIO / ESQUADRO DE PRECISÃO EM AÇO

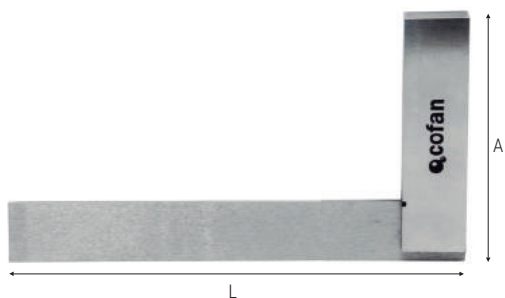

Ref	L	A		
0951 4292	50 mm	50 mm	1	12,58
0951 4293	75 mm	60 mm	1	13,36
0951 4294	100 mm	75 mm	1	14,77
0951 4295	150 mm	100 mm	1	17,32
0951 4297	225 mm	160 mm	1	43,26
0951 4299	300 mm	210 mm	1	74,67

ESCUADRA CON BISEL REGULABLE / BISEAU RÉGLABLE / ADJUSTABLE SQUARE / SQUADRA REGOLABILE / SUTA RUGULÁVEL

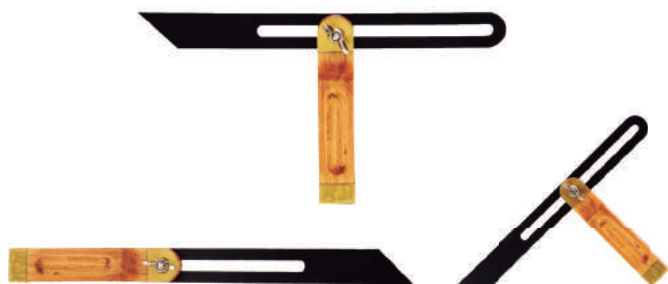

Ref			
0951 4291	250 mm	1	13,42

MICRÓMETRO PARA EXTERIORES / MICROMÈTRE EXTÉRIEUR / OUTER MICROMETER / MICROMETRI PER ESTERNI / MICRÔMETRO EXTERNO



Ref			
0951 4302	0-25 mm	1	100,42
0951 4303	25-50 mm	1	104,78
0951 4304	50-75 mm	1	128,27
0951 4305	75-100 mm	1	155,11

PEINES PARA ROSCAS / COMPTE FILS / KITS FOR THREADS / CONTAFILETTI / PENTES PARA ROSCAS



Ref			
0994 0002	Metric - Whitworth - SAE	1	17,14

GALGAS DE ESPESORES / MEULE ÉPAISSEUR / THICKNESS GAUGE / SPESSIMETRI / CALIBRADORES DE ESPESURA



Ref		mm	Inch				
0950 3260	8	0.05-0.5	0.0002-0.020	150 mm	80 g	1	6 13,64
0950 3261	18	0.05-1.0	0.002-0.040	100 mm	80 g	1	6 9,52



REGLAS DE ACERO / RÈGLES EN ACIER / STEEL RULER / RIGHELLI IN ACCIAIO / RÉGUA DE AÇO



Ref	↔	📦	📦
<b>0994 0101</b>	150 mm	1	<b>2,50</b>
<b>0994 0102</b>	300 mm	1	<b>5,10</b>
<b>0994 0103</b>	450 mm	1	<b>10,92</b>
<b>0994 0104</b>	600 mm	1	<b>14,51</b>
<b>0994 0105</b>	1000 mm	1	<b>25,53</b>
<b>0994 0106</b>	1200 mm	1	<b>49,14</b>

REGLA DE MADERA COLOR AMARILLO / RÈGLE BOIS COULEUR JAUNE / YELLOW FOLDING RULE  
METRO MURATORE IN LEGNO COLORE GIALLO / RÉGUA DE MADEIRA COR AMARELO



Ref	↔	📦	📦	📦
<b>0994 0107</b>	2 m	1	6	<b>10,48</b>

MEDIDOR DISTANCIAS LÁSER 10 FUNCIONES / MESUREUR DISTANCES LASER 10 FONCTIONS / LASER DISTANCE METER 10 FUNCTIONS  
MISURATORE LASER DI DISTANZE 10 FUNZIONI / MEDIDOR DISTÂNCIAS LASER 10 FUNÇÕES



ES Mide distancia, área, volumen, distancia indirecta por el Teorema de Pitágoras, nivel automático / altura automática. IP65 Protección contra el polvo y el agua. 3 pilas recargables AAA con una mayor duración. Visualización del ángulo digital para mejorar la experiencia al medir. Pantalla de visualización HD de 2 pulgadas, blanco sobre negro, facilitando la lectura bajo el sol. Resistente a los golpes. USB Tipo C. Carga las pilas mediante USB-C. Medición del ángulo digital.

FR Mesure les distances, les zones, les volumes, les distances indirectes par le Théorème de Pythagore, niveau automatique/hauteur automatique. IP65 Protection contre la poussière et l'eau. 3 piles rechargeables AAA avec une plus grande durée de vie. Visualisation de l'angle numérique pour améliorer l'expérience en mesurant. Écran de visualisation HD de 2 pouces, blanc sur noir, facilitant la lecture sous le soleil. Protection contre la poussière et l'eau. Chargement des piles par USB-C. Mesure de l'angle numérique.

EN Measures distance, area, volume, indirect distance by Pythagorean Theorem, auto level / auto height. IP65 Dustproof and waterproof. 3 x AAA rechargeable batteries with longer life span. Digital angle display for better measuring experience. 2-inch HD display screen, white on black, for better readability under the sun. Shock-resistant. USB Type C. Charge batteries by USB-C. Digital angle measurement.

IT Misura distanza, area, volume, distanza indiretta per il Teorema di Pitagora, livello automatico / altezza automatica. IP65 Protezione contro polvere e acqua. 3 pile ricaricabili AAA con una maggiore durata. Visualizzazione dell'angolo digitale per migliorare l'esperienza della misura. Schermata di visualizzazione HD da 2 pollici, bianco con sfondo nero, facilitando la lettura sotto i raggi solari. Resistente agli urti. USB tipo C. Carica le pile mediante USB-C. Misurazione dell'angolo digitale.

PT Mede distância, área, volume, distância indireta pelo teorema de Pitágoras, nivel automático / altura automática. IP65 Proteção contra poeiras e água. 3 pilhas AAA recarregáveis com mais duração. Exibição do ângulo digital para melhorar a experiência de medição. Visor HD de 2 polegadas, branco em preto, facilitando a leitura no sol. Resistente a choques. USB Tipo C. Carregue as baterias usando USB-C. Medição do ângulo digital.

Ref	↔	📦	📦
<b>1049 5001</b>	60 m	1	<b>125,97</b>
<b>1049 5002</b>	100 m	1	<b>212,40</b>



COMPÁS DE MUELLE PARA INTERIOR / COMPAS DE MESURE INTÉRIEUR, AVEC RESSORT / SCRIBING COMPASS, INTERIOR  
COMPASSO PER INTERNI, A MOLLA / COMPASSO DE MOLA INTERNO



Ref	↔	📦	📊	📄
0951 4275	150 mm	1	10,92	✓
0951 4276	200 mm	1	13,10	✓
0951 4277	250 mm	1	16,59	✓
0951 4278	300 mm	1	20,33	✓

COMPÁS DE MUELLE PARA EXTERIOR / COMPAS DE MESURE EXTÉRIEUR, AVEC RESSORT / SCRIBING COMPASS, EXTERIOR  
COMPASSO PER ESTERNI, A MOLLA / COMPASSO DE MOLA ESTERNO



Ref	↔	📦	📊	📄
0951 4281	150 mm	1	10,92	✓
0951 4282	200 mm	1	13,10	✓
0951 4283	250 mm	1	16,59	✓
0951 4284	300 mm	1	20,33	✓

COMPÁS DE MUELLE PUNTAS / COMPAS DE MESURE À POINTES AVEC RESSORT / SCRIBING COMPASS, WITH SHARP POINTS  
COMPASSO PER TRACC. NORMALE A PUNTA / COMPASSO DE MOLAS COM PONTAS



Ref	↔	📦	📊	📄
0951 4285	150 mm	1	10,92	✓
0951 4286	200 mm	1	13,10	✓
0951 4287	250 mm	1	16,59	✓
0951 4288	300 mm	1	20,33	✓

COMPÁS DE PUNTAS CON SOPORTE Y FIJADOR / COMPAS À POINTES AVEC SUPPORT ET FIXATION / SCRIBING COMPASS, WITH SUPPORT AND SHARP POINT  
COMPASSO PER TRACC. CON ARCO A PUNTA / COMPASSO DE PONTAS COM SUPORTE E FIXADOR



Ref	↔	📦	📊	📄
0951 4290	200 mm	1	26,42	✓



AGUJA DE TRAZAR DE BOLSILLO / POINTE Á TRACER DE POCHE / POCKET SCRIBER / PUNTA PER TRACCIARE TASCABILE / RISCADOR DE BOLSO



Ref	↔	📦	📦
0951 4306	150 mm	1	10,19

RECOGEDORES TELESCÓPICOS CON CLIP DE BOLSILLO / DOIGT MAGNETIQUE TELESCOPIQUE POCHE Á CLIPS / TELESCOPIC JOINT PICK UP POCKET CLIP  
TELESCOPIO PRENSIBLE CON CLIP TASCABILE / EXTENSÃO TELESCÓPICA MAGNÉTICA COM CLIP PARA BOLSO



Ref	∅	↔	CAP	📦	📦
0951 4307	7 mm	635 mm	680 g	1	30,46
0951 4308	9 mm	535 mm	910 g	1	31,78
0951 4309	10 mm	610 mm	2.250 g	1	45,94
0951 4310	10 mm	615 mm	3.620 g	1	52,44
0951 4311	10 mm	615 mm	4.530 g	1	61,96

ESPEJO DE INSPECCIÓN TELESCÓPICA ARTICULADO / MIROIR D'INPECTION TELESCOPIQUE / TELESCOPIC JOINT INSPECTION MIRROR  
TELESCOPIO A SPECCHIO PER ISPEZIONI SNODATO / ESPELHO TELESCÓPICO ARTICULADO



Ref	∅	↔	📦	📦
0951 4312	1,25"	502 mm	1	55,34

SOLDADOR CILÍNDRICO / SOUDEUR Á L'ÉTAIN / SOLDERING IRON / SALDATORE IN STAGNO / SOLDADOR CILÍNDRICO



Ref	⚡	W	°C	↔	📦	📦
0950 8032	220-240V (50-60Hz)	30	300	200 mm	1	57,24
0950 8034	220-240V (50-60Hz)	60	380	230 mm	1	67,17

SOPORTE PARA SOLDAR ESTAÑO / SUPPORT POUR SOUDEUR A L'ÉTAIN / TELESCOPIC JOINT INSPECTION MIRROR  
TELESCOPIO SNODATO PER ISPEZIONI A SPECCHIO / SUPORTE PARA SOLDAR ESTANHO



Ref	📦	📦
0950 8037	1	29,13



DESOLDADOR CON BOQUILLA ANTIESTÁTICA / PISTOLET À COLLE / DESOLDERING PUMP WITH ANTI-STATIC RUBBER NOZZLE  
POMPETTA PER DISSALDARE / BOMBA DESSOLDAGEM COM BICO DE BORRACHA ANTI-ESTÁTICA



Ref	∅	↔	📦	📦
0950 8035	5 mm	170 mm	1	28,90

ESCUADRA MAGNÉTICA PARA SOLDAR / CARRÉ MAGNÉTIQUE POUR SOUDER / MAGNETIC WELDING HOLDER  
SQUADRA MAGNETICA PER SALDATURA / ESQUADRO MAGNÉTICO PARA SOLDAR



Ref	↔	📦	📦	📦
0951 7115	85 x 85 mm	1	6	16,28

## CEPILLOS / PINCEAUX / BRUSHES / SPAZZOLE / ESCOVIAS

CEPILLO SOLDADURA ACERO FILAS-2 / PINCEAU DE SOUDURE ACIER 2 FILS / STEEL WELDING BRUSH 2 LINES  
SPAZZOLA IN ACCIAIO PER SALDATURA A 2 FILI / ESCOVA DE SOLDAGEM AÇO 2 FILAS



2 filas / 2 lines

Ref	📦	↔	📦	📦	📦
0951 4072	Acero / Steel	280 mm	1	12	2,98

CEPILLO SOLDADURA ACERO FILAS-4 / PINCEAU DE SOUDURE ACIER 4 FILS / STEEL WELDING BRUSH 4 LINES  
SPAZZOLA IN ACCIAIO PER SALDATURA A 4 FILI / ESCOVA DE SOLDAGEM AÇO 4 FILAS



4 filas / 4 lines

Ref	📦	↔	📦	📦	📦
0951 4071	Acero / Steel	285 mm	1	12	3,93





CEPILLO SOLDADURA ACERO FILAS-5 / PINCEAU DE SOUDURE ACIER 5 FILS / STEEL WELDING BRUSH 5 LINES  
 SPAZZOLA IN ACCIAIO PER SALDATURA A 5 FILI / ESCOVA DE SOLDAGEM AÇO 5 FILAS



5 filas / 5 lines

Ref					
0951 4073	Acero / Steel	280 mm	1	12	4,34

CEPILLO SOLDADURA ACERO FILAS 6 / PINCEAU DE SOUDURE ACIER 6 FILS / STEEL WELDING BRUSH 6 LINES  
 SPAZZOLA IN ACCIAIO PER SALDATURA A 6 FILI / ESCOVA DE SOLDAGEM AÇO 6 FILAS



6 filas / 6 lines

Ref					
0951 4070	Acero / Steel	287 mm	1	12	4,74

CEPILLO PARA BUJÍAS ACERO LATONADO / PINCEAU DE SOUDURE POUR BOUGIES ACIER LAITON / BRASSED STEEL BRUSH FOR SPARK PLUGS  
 SPAZZOLA IN ACCIAIO OTTONATO A / ESCOVA PARA VELAS EM AÇO BRONZEADO



3 filas / 3 lines

Ref					
0951 4077	Acero Latonado Brassed Steel	150 mm	1	24	2,86

CEPILLO UNIVERSAL ACERO LATONADO / PINCEAU DE SOUDURE UNIVERSEL ACIER LAITON / UNIVERSAL BRASSED STEEL BRUSH  
 SPAZZOLA UNIVERSALE IN ACCIAIO OTTONATO / ESCOVA UNIVERSAL EM AÇO BRONZEADO



Ref				
0951 4068	Acero Latonado Brassed Steel	240 mm	1	2,75

CEPILLO BARRENDERO RASPADOR METAL / BALAI DE CANTONIER GRATOIR MÉTAL / SWEEPING BRUSH METAL SCRAPER  
 SPAZZOLONE SPAZZINO RASCHIETTO METALLICO / ESCOVA VASSOURA RASPADOR DE METAL



Ref				
0930 1210	28 mm	40 cm	1	27,77



CEPILLO BARRENDERO EXTRA / BALAI DE CANTONIER EXTRA / SWEEPING BRUSH COFAN EXTRA  
 SPAZZOLONE SPAZZINO EXTRA / ESCOVA VASSOURA EXTRA



Ref	↔	📏	📦	📦
<b>0930 1221</b>	52 cm	1	12	<b>5,46</b>

CEPILLO BARRENDERO COFAN FIBRA DURO / BALAI DE CANTONIER COFAN FIBRE RENFORCEE / SWEEPING BRUSH COFAN FIBRE  
 SPAZZOLONE SPAZZINO COFAN FIBRA DURA / ESCOVA VASSOURA COFAN FIBRA DURA



Ref	↔	📏	📦	📦
<b>0930 1222</b>	40 cm	1	12	<b>5,30</b>

CEPILLO BARRENDERO ONDULADO IMITACIÓN MIJO / BALAI DE CANTONIER ONDULÉ / SWEEPING BRUSH WAVY MILLET IMITATION  
 SPAZZOLONE SPAZZINO ONDULATO / ESCOVA VASSOURA ONDULAÇÃO



Ref	↔	📏	📦	📦
<b>0930 1223</b>	50 cm	1	12	<b>6,23</b>

CEPILLO INDUSTRIAL PELO MEZCLA / BALAI INDUSTRIEL POIL MÉLANGE / INDUSTRIAL BROOM MIX  
 SPAZZOLONE INDUSTRIALE CRINE MISTE / VASSOURA INDUSTRIAL MISTURA DE CERDAS



Ref	∅	↔	📏	📦	📦
<b>0930 1451</b>	ROSCA 28 mm	50 cm	1	6	<b>17,47</b>

CEPILLO INDUSTRIAL PLASTIC SUAVE / BALAI INDUSTRIEL PLASTIQUE LISSE / INDUSTRIAL BROOM SOFT PLASTIC  
 SPAZZOLONE INDUSTRIALE IN PLASTICA MORBIDA / VASSOURA INDUSTRIAL PLÁSTICO SUAVE



Ref	∅	↔	📏	📦	📦
<b>0930 1452</b>	ROSCA 28 mm	50 cm	1	6	<b>9,88</b>



CEPILLO INDUSTRIAL BARRENDERO ROSCA / BALAI INDUSTRIEL FILETE / INDUSTRIAL SWEEPING BRUSH THREAD  
 SPAZZOLONE INDUSTRIALE SPAZZINO / VASSOURA INDUSTRIAL DE ROSCA



Ref	∅	↔	📦	📦	📦
<b>0930 1453</b>	ROSCA 28 mm	50 cm	1	6	<b>9,46</b>

CEPILLO INDUSTRIAL IMITACIÓN MIJO / BALAI INDUSTRIEL FILETE / INDUSTRIAL BROOM MILLET IMITATION  
 SPAZZOLONE INDUSTRIALE SPAZZINO / VASSOURA INDUSTRIAL DE ROSCA



Ref	∅	↔	📦	📦	📦
<b>0930 1454</b>	ROSCA 28 mm	50 cm	1	6	<b>12,17</b>

CEPILLO INDUSTRIAL PLASTIC SUAVE / CEPILLO INDUSTRIEL PLASTIQUE LISSE / INDUSTRIAL BROOM SOFT PLASTIC  
 SPAZZOLONE INDUSTRIALE CON CRINE IN PLASTICA MORBIDA / VASSOURA INDUSTRIAL PLÁSTICO SUAVE



Ref	∅	↔	📦	📦	📦
<b>0930 1461</b>	ROSCA 28 mm	60 cm	1	6	<b>15,18</b>

CEPILLO INDUSTRIAL PLASTIC RÍGIDO / BALAI INDUSTRIEL PLASTIQUE RIGIDE / INDUSTRIAL BROOM RIGID PLASTIC  
 SPAZZOLONE INDUSTRIALE CON CRINE IN PLASTICA RIGIDA / VASSOURA INDUSTRIAL PLÁSTICO RIGIDO



Ref	∅	↔	📦	📦	📦
<b>0930 1462</b>	ROSCA 28 mm	60 cm	1	1	<b>12,17</b>

MANGO MADERA CEPILLO / MANCHE A BALAIS EN BOIS / WOODEN BRUSH HANDLE  
 MANICO IN LEGNO PER SPAZZOLONE / CABO MADEIRA ESCOVA



Sin rosca / Sans filetage / Without thread / Senza filettatura / Sem rosca

Ref	∅	↔	📦	📦	📦
<b>0930 1241</b>	28 mm	1,20 m	1	12	<b>2,80</b>



Con rosca / Avec filetage / With thread / Con filettatura / Com rosca

Ref	∅	↔	📦	📦	📦
<b>0930 1242</b>	28 mm	1,20 m	1	24	<b>2,91</b>



CEPILLO LAVACOCHEs PVC/ BRUSSE DE LAVAGE POUR VOITURE PVC / PVC CAR WASH BRUSH THREAD  
 SPAZZOLA PERO LAVAGGIO AUTO PVC / ESCOVA DE LAVAGEM AUTO PVC



Ref	↔	↑↓	▮	📦	📦	📏	📦
<b>0930 1481</b>	242 mm	80 mm	57 mm	1	24	Ø22mm	<b>16,36</b>

CEPILLO LAVACOCHEs PVC PROFESIONAL CON CANAL DE AGUA / BRUSSE DE LAVAGE POUR VOITURE PVC PROFESSIONEL, AVEC CANAL D'EAU  
 PROFESSIONAL WITH WATERWAY PVC CAR WASH BRUSH THREAD / SPAZZOLA PERO LAVAGGIO AUTO PVC PROFESSIONALE CON CANALE ACQUA  
 ESCOVA DE LAVAGEM AUTO PVC PROFESIONAL COM CANAL DE ÁGUA



Ref	↔	↑↓	▮	📦	📦	📏	📦
<b>0930 1482</b>	330 mm	72 mm	57 mm	1	15		<b>20,05</b>

BARRA METAL CEPILLO LAVACOCHEs+ENCHUFE RÁPIDO / MANCHE EN MÉTAL DE BRUSSE DE LAVAGE POUR VOITURE + RACCORD RAPIDE  
 METAL STICK FOR CAR WASH BRUSH + FIT / ASTA DI METALLO PER SPAZZOLA PER LAVAGGIO AUTO + PRESA RAPIDA  
 BARRA DE METAL ESCOVA DE LAVAGEM AUTO + ACOPLAMENTO RÁPIDO



Válido para cepillo 0930 1482  
 Suitable for brush with p/n 0930 1482



Ref	↔	📦	📦	📏
<b>0930 1485</b>	90 cm	1	15	<b>15,30</b>
<b>0930 1586</b>	180cm	1	15	<b>19,76</b>



GARRA METÁLICA GALVANIZADA CEPILLO BARRENDERO / GRIFFE MÉTALLIQUE GALVANISÉE BALAI DE CANTONIER  
GALVANISED METAL BRACKET SWEEPING BRUSH / ARTIGLIO METALLICO GALVANIZZATO PER SPAZZOLONE  
GARRA DE METAL GALVANIZADO ESCOVA DE VARRER



Mango madera / Handle: 0930 1242



Ref	∅	⊞	📦	📦	📦
0930 1245	28 mm	1	12	12	2,39

HARAGÁN METÁLICO INDUSTRIAL / RACLETTE CAOUTCHOUC METALLIQUE INDUSTRIELLE / INDUSTRIAL METAL SQUEEGEE  
SPAZZOLA METALLICA LAVAVETRI INDUSTRIALE / RODO METÁLICO INDUSTRIAL



Mango madera / Handle: 0930 1242



Mango aluminio / Handle: 4100 3121



Ref	∅	↔	⊞	📦	📦
0930 1345	22 - 29 mm	45 cm	1	10	7,54
0930 1360	22 - 29 mm	60 cm	1	10	9,26
0930 1375	22 - 29 mm	75 cm	1	10	16,12

MOPA PLANA LIMPIADORA / BALAI SERPILLERE PLAT / SWIVEL DUST MOP / SPAZZOLONE RACCOGLIPOLVERE / MOPA PLANA LIMPEZA



Mango madera / Handle: 0930 1242



Mango aluminio / Handle: 4100 3121



Ref	∅	↔	⊞	📦	📦
0930 1101	22 - 29 mm	45 cm	1	6	19,66
0930 1102	22 - 29 mm	60 cm	1	6	25,17
0930 1103	22 - 29 mm	75 cm	1	6	29,64
0930 1104	22 - 29 mm	100 cm	1	6	35,88

RECAMBIO MOPA PLANA LIMPIADORA / PIECE DE RECHANGE BALAI SERPILLERE PLAT / SPARE SWIVEL DUST MOP  
RICAMBIO SCOPA RACCOGLIPOLVERE / RECARGA MOPA PLANA LIMPEZA



Ref	↔	⊞	📦	📦
0930 1101R	45 cm	1	12	13,00
0930 1102R	60 cm	1	12	16,22
0930 1103R	75 cm	1	12	19,66
0930 1104R	100 cm	1	12	24,75





RUEDA DOBLE Ø50 mm CON PLACA / ROULETTE DOUBLE Ø50 mm AVEC PLAQUE / Ø50 mm DOUBLE WHEEL, WITH PLATE  
 DOPPIA RUOTA Ø50 mm CON PIASTRA / RODA DUPLA Ø50 mm COM PLACA



Polipropileno / Polypropylene

Ref								Kg↓		
0940 3405	50 mm	60 x 60 mm	48/39x48/38 mm	6,3 mm	25 mm	70 mm	70	1	5,55	

RUEDA DOBLE Ø50 mm PLACA/FRENO / ROULETTE DOUBLE Ø50 mm PLAQUE/FREIN / Ø50 mm DOUBLE WHEEL, PLATE/BREAK  
 DOPPIA RUOTA Ø50 mm PIASTRA/FRENO / RODA DUPLA Ø50 mm PLACA /FRENO



Polipropileno / Polypropylene

Ref								Kg↓		
0940 3425	50 mm	60 x 60 mm	48/39x48/38 mm	6,3 mm	25 mm	70 mm	80 mm	70	1	7,00

RUEDA DOBLE Ø50 mm PASANTE / ROULETTE DOUBLE Ø50 mm A OEIL / Ø50 mm DOUBLE WHEEL, THROUGH HOLE  
 DOPPIA RUOTA Ø50 mm INTERNA / RODA DUPLA Ø50 mm PASSANTE



Polipropileno / Polypropylene

Ref						Kg↓		
0940 3435	50 mm	12 mm	25 mm	70 mm	70	1	5,25	

RUEDA DOBLE Ø50 mm PASANTE/FRENO / ROULETTE DOUBLE Ø50 mm A OEIL/FREIN / Ø50 mm DOUBLE WHEEL, THROUGH HOLE/BREAK  
 DOPPIA RUOTA Ø50 mm INTERNA/FRENO / RODA DUPLA Ø50 mm PASSANTE /FREIO



Polipropileno / Polypropylene

Ref							Kg↓		
0940 3445	50 mm	12 mm	25 mm	70 mm	80 mm	70	1	7,00	

RUEDA NYLON CON PLACA / ROULETTE NYLON AVEC PLAQUE / NYLON WHEEL WITH PLATE  
 RUOTA IN NYLON CON PIASTRA / RODA NYLON COM PLACA



Cajinete Liso

Ref								Kg↓		
0940 3101	80 mm	30 mm	105x80 mm	80/77x60 mm	9 mm	40 mm	105 mm	100	1	6,80
0940 3102	100 mm	30 mm	105x80 mm	80/77x60 mm	9 mm	40 mm	125 mm	120	1	7,70
0940 3103	125 mm	40 mm	105x80 mm	80/77x60 mm	9 mm	40 mm	155 mm	150	1	10,50



RUEDA NYLON PLACA/FRENO / ROULETTE NYLON PLAQUE/FREIN / NYLON WHEEL, PLATE/BREAK  
RUOTA IN NYLON PIASTRA/FRENO / RODA NYLON PLACA/FREIO



Cojinete Liso

Ref									Kg↓		
<b>0940 3121</b>	80 mm	30 mm	105x80 mm	80/77x60 mm	9 mm	45 mm	105 mm	128 mm	100	1	<b>9,20</b>
<b>0940 3122</b>	100 mm	30 mm	105x80 mm	80/77x60 mm	9 mm	45 mm	125 mm	128 mm	120	1	<b>10,50</b>
<b>0940 3123</b>	125 mm	40 mm	105x80 mm	80/77x60 mm	9 mm	45 mm	155 mm	139 mm	150	1	<b>13,80</b>

RUEDA NYLON FIJA / ROULETTE NYLON FIXE / FIXED NYLON WHEEL / RUOTA FISSA IN NYLON / RODA NYLON FIXA



Cojinete Liso

Ref							Kg↓		
<b>0940 3111</b>	80 mm	30 mm	105x80 mm	80/77x60 mm	9 mm	105 mm	100	1	<b>5,10</b>
<b>0940 3112</b>	100 mm	30 mm	105x80 mm	80/77x60 mm	9 mm	125 mm	120	1	<b>7,20</b>
<b>0940 3113</b>	125 mm	40 mm	105x80 mm	80/77x60 mm	9 mm	155 mm	150	1	<b>9,80</b>

RUEDA GOMA AZUL PLACA / ROULETTE CAOUTCHOUC BLEUE PLAQUE / BLUE RUBBER WHEEL, PLATE  
RUOTA BLU IN GOMMA, PIASTRA / RODA BORRACHA AZUL PLACA



Cojinete Rodillo

Ref								Kg↓		
<b>0940 3301</b>	80 mm	35 mm	105x80 mm	80/77x60 mm	9 mm	40 mm	105 mm	100	1	<b>10,80</b>
<b>0940 3302</b>	100 mm	35 mm	105x80 mm	80/77x60 mm	9 mm	40 mm	125 mm	120	1	<b>11,20</b>
<b>0940 3303</b>	125 mm	38 mm	105x80 mm	80/77x60 mm	9 mm	40 mm	155 mm	150	1	<b>15,50</b>

RUEDA GOMA AZUL FIJA / ROULETTE CAOUTCHOUC BLEUE FIXE / FIXED BLUE RUBBER WHEEL  
RUOTA FISSA IN GOMMA BLU / RODA BORRACHA AZUL FIXA



Cojinete Rodillo

Ref							Kg↓		
<b>0940 3311</b>	80 mm	35 mm	105x80 mm	80/77x60 mm	9 mm	105 mm	100	1	<b>9,50</b>
<b>0940 3312</b>	100 mm	35 mm	105x80 mm	80/77x60 mm	9 mm	125 mm	120	1	<b>10,20</b>
<b>0940 3313</b>	125 mm	38 mm	105x80 mm	80/77x60 mm	9 mm	155 mm	150	1	<b>14,80</b>

RUEDA GOMA AZUL PLACA/FRENO / ROULETTE CAOUTCHOUC BLEUE PLAQUE/FREIN / BLUE RUBBER WHEEL, PLATE/BREAK  
RUOTA BLU IN GOMMA, PIASTRA/FRENO / RODA BORRACHA AZUL PLACA/FREIO



Cojinete Rodillo

Ref									Kg↓		
<b>0940 3321</b>	80 mm	35 mm	105x80 mm	80/77x60 mm	9 mm	45 mm	105 mm	128 mm	100	1	<b>14,50</b>
<b>0940 3322</b>	100 mm	35 mm	105x80 mm	80/77x60 mm	9 mm	45 mm	125 mm	128 mm	120	1	<b>15,00</b>
<b>0940 3323</b>	125 mm	38 mm	105x80 mm	80/77x60 mm	9 mm	45 mm	155 mm	139 mm	150	1	<b>20,50</b>



RUEDA POLIURETANO PLACA / ROULETTE POLYURÉTHANE PLAQUE / POLYURETHANE WHEEL, PLATE  
RUOTA IN POLIURETANO, PIASTRA / RODA POLIURETANO PLACA



Cojinete Liso

Ref									Kg↓		
<b>0940 3201</b>	80 mm	30 mm	105x80 mm	80/77x60 mm	9 mm	40 mm	105 mm	100	1	<b>11,20</b>	
<b>0940 3202</b>	100 mm	30 mm	105x80 mm	80/77x60 mm	9 mm	40 mm	125 mm	120	1	<b>12,50</b>	
<b>0940 3203</b>	125 mm	35 mm	105x80 mm	80/77x60 mm	9 mm	40 mm	155 mm	150	1	<b>17,30</b>	

RUEDA POLIURETANO PLACA/FRENO / ROULETTE POLYURÉTHANE PLAQUE/FREIN / POLYURETHANE WHEEL, PLATE/BREAK  
RUOTA IN POLIURETANO, PIASTRA/FRENO / RODA POLIURETANO PLACA /FREIO



Cojinete Liso

Ref									Kg↓		
<b>0940 3221</b>	80 mm	30 mm	105x80 mm	80/77x60 mm	9 mm	45 mm	105 mm	128 mm	100	1	<b>14,20</b>
<b>0940 3222</b>	100 mm	30 mm	105x80 mm	80/77x60 mm	9 mm	45 mm	125 mm	128 mm	120	1	<b>15,80</b>
<b>0940 3223</b>	125 mm	35 mm	105x80 mm	80/77x60 mm	9 mm	45 mm	155 mm	139 mm	150	1	<b>19,90</b>

RUEDA POLIURETANO FIJA / ROULETTE POLYURÉTHANE FIXE / FIXED POLYURETHANE WHEEL  
RUOTA FISSA IN POLIURETANO / RODA POLIURETANO FIXA



Cojinete Liso

Ref							Kg↓		
<b>0940 3211</b>	80 mm	80/77x60 mm	30 mm	40 mm	104 mm	9 mm	100	1	<b>10,50</b>
<b>0940 3212</b>	100 mm	80/77x60 mm	30 mm	40 mm	124 mm	9 mm	120	1	<b>11,20</b>
<b>0940 3213</b>	125 mm	80/77x60 mm	35 mm	40 mm	154 mm	9 mm	150	1	<b>15,50</b>

RUEDA POLIURETANO PASANTE / ROULETTE POLYURÉTHANE A OEIL / POLYURETHANE WHEEL, THROUGH HOLE  
RUOTA IN POLIURETANO INTERNO / RODA POLIURETANO PASSANTE



Cojinete Liso

Ref						Kg↓		
<b>0940 3231</b>	80 mm	30 mm	40 mm	104 mm	13 mm	100	1	<b>11,50</b>
<b>0940 3232</b>	100 mm	30 mm	40 mm	124 mm	13 mm	120	1	<b>12,90</b>
<b>0940 3233</b>	125 mm	35 mm	40 mm	154 mm	13 mm	150	1	<b>17,50</b>

RUEDA POLIURETANO PASANTE/FRENO / ROULETTE POLYURÉTHANE A OEIL/FREIN / POLYURETHANE WHEEL, THROUGH HOLE/BREAK  
RUOTA IN POLIURETANO INTERNO/FRENO / RODA POLIURETANO PASSANTE/FREIO



Cojinete Liso

Ref							Kg↓		
<b>0940 3241</b>	80 mm	30 mm	40 mm	104 mm	13 mm	127 mm	100	1	<b>14,80</b>
<b>0940 3242</b>	100 mm	30 mm	40 mm	124 mm	13 mm	127 mm	120	1	<b>16,00</b>
<b>0940 3243</b>	125 mm	35 mm	40 mm	154 mm	13 mm	139 mm	150	1	<b>20,00</b>



RUEDA PLÁSTICO PLACA / ROULETTE PLASTIQUE PLAQUE / PLASTIC WHEEL, PLATE / RUOTA IN PLASTICA, PIASTRA / RODA PLÁSTICO PLACA



Ref	⊙	⊥	⊠	⊠	⊠	⊠	Kg↓	📦	📦
<b>0940 3461</b>	30 mm	7 mm	42x42 mm	32x32 mm	5 mm	35 mm	15	4	<b>0,80</b>
<b>0940 3471</b>	40 mm	8 mm	42x42 mm	32x32 mm	5 mm	54 mm	20	4	<b>1,15</b>
<b>0940 3483</b>	50 mm	10 mm	42x42 mm	32x32 mm	5 mm	63 mm	25	4	<b>1,35</b>

RUEDA PLÁSTICO PLACA/FRENO / ROULETTE PLASTIQUE PLAQUE/FREIN / PLASTIC WHEEL, PLATE/BREAK  
RUOTA IN PLASTICA, PIASTRA/FRENO / RODA PLÁSTICO PLACA/FREIO



Ref	⊙	⊥	⊠	⊠	⊠	⊠	Kg↓	📦	📦
<b>0940 3472</b>	40 mm	8 mm	42x42 mm	32x32 mm	5 mm	54 mm	20	4	<b>1,35</b>
<b>0940 3484</b>	50 mm	10 mm	42x42 mm	32x32 mm	5 mm	63 mm	25	4	<b>1,45</b>

RUEDA PLÁSTICO TORNILLO / ROULETTE PLASTIQUE VIS / PLASTIC WHEEL, SCREW / RUOTA IN PLASTICA, A VITE / RODA PLÁSTICO PARAFUSO



Ref	⊙	⊥	M	⊠	⊠	📦	Kg↓	📦	📦
<b>0940 3462</b>	30 mm	7 mm	6x15 mm	35 mm	29 mm	33 mm	15	4	<b>0,80</b>
<b>0940 3474</b>	40 mm	8 mm	6x15 mm	65 mm	40 mm	39 mm	20	4	<b>1,00</b>
<b>0940 3473</b>	40 mm	8 mm	8x15 mm	65 mm	40 mm	39 mm	20	4	<b>1,10</b>
<b>0940 3486</b>	50 mm	10 mm	8x15 mm	73 mm	48 mm	45 mm	25	4	<b>1,20</b>
<b>0940 3485</b>	50 mm	10 mm	10x15 mm	73 mm	48 mm	45 mm	25	4	<b>1,30</b>

RUEDA PLÁSTICO FRENO/TORNILLO / ROULETTE PLASTIQUE FREIN/VIS / PLASTIC WHEEL, BREAK/SCREW  
RUOTA IN PLASTICA, FRENO/A VITE / RODA PLÁSTICO FREIO PARAFUSO



Ref	⊙	⊥	M	⊠	⊠	📦	Kg↓	📦	📦
<b>0940 3465</b>	40 mm	8 mm	8x15 mm	65 mm	46 mm	39 mm	20	4	<b>1,30</b>
<b>0940 3482</b>	50 mm	10 mm	8x15 mm	73 mm	59 mm	45 mm	25	4	<b>1,35</b>
<b>0940 3481</b>	50 mm	10 mm	10x15 mm	73 mm	59 mm	45 mm	25	4	<b>1,40</b>

RUEDA POLIPROPILENO PLACA / ROULETTE POLYPROPYLÈNE PLAQUE / POLYURETHANE WHEEL, PLATE  
RUOTA IN POLIPROPILENE, PIASTRA / RODA POLIPROPILENO PLACA



Ref	⊙	⊥	⊠	⊠	⊠	⊠	Kg↓	📦	📦
<b>0940 3451</b>	25 mm	15 mm	42x42 mm	32x32 mm	5 mm	48 mm	20	1	<b>1,60</b>
<b>0940 3452</b>	30 mm	15 mm	42x42 mm	32x32 mm	5 mm	50 mm	25	1	<b>1,65</b>
<b>0940 3453</b>	40 mm	20 mm	42x42 mm	32x32 mm	5 mm	53 mm	40	1	<b>2,10</b>
<b>0940 3454</b>	50 mm	18 mm	42x42 mm	32x32 mm	5 mm	64 mm	40	1	<b>2,30</b>



RUEDA POLIPROPILENO PLACA/FRENO / ROULETTE POLYPROPYLENE PLAQUE/FREIN / POLYURETHANE WHEEL, PLATE/BREAK  
 RUOTA IN POLIPROPILENE, PIASTRA/FRENO / RODA POLIPROPILENO PLACA/FREIO



Ref	⊙	⊘	⊠	⊡	⊢	⊣	Kg↓	📦	📊
<b>0940 3458</b>	40 mm	20 mm	42x42 mm	32x32 mm	5 mm	53 mm	40	1	<b>3,10</b>
<b>0940 3459</b>	50 mm	18 mm	42x42 mm	32x32 mm	5 mm	64 mm	40	1	<b>3,35</b>

RUEDA GOMA/GRIS PLACA / ROULETTE CAOUTCHOUC/GRIS PLAQUE / RUBBER/GREY WHEEL, PLATE  
 RUOTA GRIGIA IN GOMMA, PIASTRA / RODA BORRACHA/CINZA PLACA



Ref	⊙	⊘	⊠	⊡	⊢	⊣	Kg↓	📦	📊
<b>0940 3604</b>	40 mm	18 mm	42x42 mm	32x32 mm	4,5 mm	55 mm	32	1	<b>2,55</b>
<b>0940 3605</b>	50 mm	18 mm	42x42 mm	32x32 mm	4,5 mm	64 mm	50	1	<b>2,80</b>
<b>0940 3606</b>	65 mm	21 mm	60x60 mm	45x45 mm	6,5 mm	79 mm	60	1	<b>3,40</b>
<b>0940 3607</b>	75 mm	22 mm	60x60 mm	45x45 mm	6,5 mm	100 mm	70	1	<b>4,60</b>

RUEDA GOMA/GRIS PLACA/FRENO / ROULETTE CAOUTCHOUC/GRIS PLAQUE/FREIN / RUBBER/GREY WHEEL, PLATE/BREAK  
 RUOTA GRIGIA IN GOMMA, PIASTRA/FRENO / RODA BORRACHA/CINZA PLACA/FREIO



Ref	⊙	⊘	⊠	⊡	⊢	⊣	Kg↓	📦	📊
<b>0940 3624</b>	40 mm	18 mm	42x42 mm	32x32 mm	4,5 mm	55 mm	32	1	<b>3,60</b>
<b>0940 3625</b>	50 mm	18 mm	42x42 mm	32x32 mm	4,5 mm	64 mm	50	1	<b>4,00</b>
<b>0940 3626</b>	65 mm	21 mm	60x60 mm	45x45 mm	6,5 mm	79 mm	60	1	<b>4,80</b>
<b>0940 3627</b>	75 mm	22 mm	60x60 mm	45x45 mm	6,5 mm	100 mm	70	1	<b>6,20</b>

RUEDA GOMA/GRIS PASANTE / ROULETTE CAOUTCHOUC/GRIS A OEIL / RUBBER/GREY WHEEL, THROUGH HOLE  
 RUOTA GRIGIA IN GOMMA, INTERNO / RODA BORRACHA/CINZA PASSANTE



Ref	⊙	⊘	⊚	⊣	Kg↓	📦	📊
<b>0940 3634</b>	40 mm	18 mm	8 mm	53 mm	32	1	<b>2,70</b>
<b>0940 3635</b>	50 mm	18 mm	8 mm	64 mm	50	1	<b>3,20</b>
<b>0940 3636</b>	65 mm	21 mm	8 mm	78,5 mm	60	1	<b>4,00</b>
<b>0940 3637</b>	75 mm	22 mm	8 mm	97 mm	70	1	<b>4,50</b>

RUEDA GOMA/GRIS PASANTE/FRENO / ROULETTE CAOUTCHOUC/GRIS A OEILE/FREIN / RUBBER/GREY WHEEL, THROUGH HOLE/BREAK  
 RUOTA GRIGIA IN GOMMA, INTERNO/FRENO / RODA BORRACHA/CINZA PASSANTE/FREIO



Ref	⊙	⊘	⊚	⊣	Kg↓	📦	📊
<b>0940 3644</b>	40 mm	18 mm	8 mm	53 mm	32	1	<b>3,70</b>
<b>0940 3645</b>	50 mm	18 mm	8 mm	64 mm	50	1	<b>4,10</b>
<b>0940 3646</b>	65 mm	21 mm	8 mm	78,5 mm	60	1	<b>5,30</b>
<b>0940 3647</b>	75 mm	22 mm	8 mm	97 mm	70	1	<b>6,10</b>





RUEDA GOMA/METAL PLACA / ROULETTE CAOUTCHOUC/MÉTAL PLAQUE / RUBBER/METAL WHEEL, PLATE  
RUOTA IN GOMMA/METALLO, PIASTRA / RODA BORRACHA/METAL PLACA



Cojinete Liso

Ref								Kg↓		
<b>0940 3501</b>	80 mm	27 mm	105x80 mm	80/77x60 mm	9 mm	40 mm	105 mm	80	1	<b>6,50</b>
<b>0940 3502</b>	100 mm	27 mm	105x80 mm	80/77x60 mm	9 mm	40 mm	125 mm	100	1	<b>7,20</b>
<b>0940 3503</b>	125 mm	38 mm	105x80 mm	80/77x60 mm	9 mm	40 mm	155 mm	150	1	<b>8,80</b>

RUEDA GOMA/METAL FIJA / ROULETTE CAOUTCHOUC/MÉTAL FIXE / FIXED RUBBER/METAL WHEEL  
RUOTA FISSA IN GOMMA/METALLO / RODA BORRACHA/METAL FIXA



Cojinete Liso

Ref							Kg↓		
<b>0940 3511</b>	80 mm	27 mm	105x80 mm	80/77x60 mm	9 mm	105 mm	80	1	<b>5,50</b>
<b>0940 3512</b>	100 mm	27 mm	105x80 mm	80/77x60 mm	9 mm	125 mm	100	1	<b>6,20</b>
<b>0940 3513</b>	125 mm	38 mm	105x80 mm	80/77x60 mm	9 mm	155 mm	150	1	<b>8,50</b>

RUEDA GOMA/METAL PLACA/FRENO / ROULETTE CAOUTCHOUC/MÉTAL PLAQUE/FREIN / RUBBER/METAL WHEEL, PLATE/BREAK  
RUOTA IN GOMMA/METALLO, PIASTRA/FRENO / RODA BORRACHA/METAL PLACA/FREIO



Cojinete Liso

Ref								Kg↓		
<b>0940 3521</b>	80 mm	27 mm	105x80 mm	80/77x60 mm	9 mm	45 mm	105 mm 128 mm	80	1	<b>9,50</b>
<b>0940 3522</b>	100 mm	27 mm	105x80 mm	80/77x60 mm	9 mm	45 mm	125 mm 128 mm	100	1	<b>10,20</b>
<b>0940 3523</b>	125 mm	38 mm	105x80 mm	80/77x60 mm	9 mm	45 mm	155 mm 128 mm	130	1	<b>13,50</b>

RUEDA TRANSP/CROMADO PLACA / ROULETTE TRANSP/CHROMEÉ PLAQUE / TRANSP/CHROM. PLATED WHEEL, PLATE  
RUOTA TRASP/CROMATA PIASTRA / RODA TRANSP/CROMADA PLACA



Ref							Kg↓		
<b>0940 3701</b>	35 mm	23 mm	42x42 mm	32x32 mm	4,5 mm	50 mm	32	1	<b>3,20</b>
<b>0940 3702</b>	50 mm	23 mm	42x42 mm	32x32 mm	4,5 mm	64 mm	40	1	<b>3,90</b>
<b>0940 3703</b>	75 mm	26 mm	60x60 mm	45x45 mm	6,5/8,5 mm	95,5 mm	64	1	<b>6,50</b>

RUEDA TRANSP/CROMADO PLACA/FRENO / ROULETTE TRANSP/CHROMEÉ PLAQUE/FREIN / TRANSP/CHROM. PLATED WHEEL, PLATE/BREAK  
RUOTA TRASP/CROMATA PIASTRA/FRENO / RODA TRANSP/CROMADA PLACA/FREIO



Ref							Kg↓		
<b>0940 3721</b>	35 mm	23 mm	42x42 mm	32x32 mm	4,5 mm	50 mm	32	1	<b>4,10</b>
<b>0940 3722</b>	50 mm	23 mm	42x42 mm	32x32 mm	4,5 mm	64 mm	40	1	<b>4,60</b>
<b>0940 3723</b>	75 mm	26 mm	60x60 mm	45x45 mm	6,5/8,5 mm	95,5 mm	64	1	<b>8,00</b>



RUEDA CARRETILLA OBRA NEUMÁTICA CON VARILLAS / ROUE BROUETTE CHANTIER PNEUMATIQUE AVEC TIGES  
CONSTRUCTION WHEELBARROW PNEUMATIC TYRE WITH RIBS / RUOTA PNEUMATICA PER CARRELLO CON PERNO  
RODA PNEUMÁTICA P/ CARRINHO DE MÃO CONSTRUÇÃO C/ TUBO



Ref				
0940 2701	20 mm	370 mm	1	15,25

RUEDA CARRETILLA OBRA IMPINCHABLE CON VARILLAS / ROUE BROUETTE CHANTIER AVEC TIGES  
CONSTRUCTION WHEELBARROW UNBREAKABLE TYRE WITH RIBS / RUOTA IMPERFORABILE PER CARRELLO CON PERNO  
RODA ANTI-FURO P/ CARRINHO DE MÃO CONSTRUÇÃO C/ TUBO



Ref				
0940 2702	20 mm	370 mm	1	21,50

RUEDA CARRETILLA OBRA LLANTA ABS NEUMÁTICA CON RODAMIENTOS / ROUE BROUETTE CHANTIER PNEU ABS PNEUMATIQUE AVEC ROULEMENTS  
CONSTRUCTION WHEELBARROW PNEUMATIC ABS RIM TYRE WITH BEARING / RUOTA PNEUMATICA PER CARRELLO CON CERCHIONE IN ABS E CUSCINETTO  
RODA JANTE ABS PNEUMÁTICA P/ CARRINHO DE MÃO CONSTRUÇÃO C/ ROLAMENTOS



Ref				
0940 2705	20 mm	370 mm	1	14,85

RUEDA CARRETILLA OBRA LLANTA ABS IMPINCHABLE CON RODAMIENTOS / ROUE BROUETTE CHANTIER PNEU ABS INCREVABLE AVEC ROULEMENTS  
CONSTRUCTION WHEELBARROW UNBREAKABLE ABS RIM TYRE WITH BEARING / RUOTA PNEUMATICA IMPERFORABILE PER CARRELLO CON CERCHIONE IN ABS E CUSCINETTO  
RODA JANTE ABS ANTI-FURO P/ CARRINHO DE MÃO CONSTRUÇÃO C/ ROLAMENTOS



Ref				
0940 2706	20 mm	370 mm	1	22,75



**RUEDA CARRETILLA / ROUE BROUETTE CHANTIER / CONSTRUCTION TYRE  
RUOTA PER CARRELLO / RODA CARRINHO DE MÃO CONSTRUÇÃO**

RUEDA CARRETILLA ALMACÉN NEUMÁTICA CON RODAMIENTO / ROUE BROUETTE MAGASIN PNEUMATIQUE AVEC ROULEMENT  
WAREHOUSE WHEELBARROW PNEUMATIC TYRE WITH BEARING / RUOTA PNEUMATICA PER MAGAZZINO CON CUSCINETTO  
RODA PNEUMÁTICA P/ CARRINHO DE MÃO ARMAZÉM C/ ROLAMENTO



Ref				
<b>0940 2711</b>	20 mm	260 mm	1	<b>8,75</b>

RUEDA CARRETILLA ALMACÉN IMPINCHABLE CON RODAMIENTO / ROUE BROUETTE MAGASIN INCREVABLE AVEC ROULEMENT  
WAREHOUSE WHEELBARROW UNBREAKABLE TYRE FOR WITH BEARING / RUOTA PNEUMATICA IMPERFORABILE PER CARRELLO CON CUSCINETTO  
RODA ANTI-FURO P/ CARRINHO DE MÃO ARMAZÉM C/ ROLAMENTO



Ref				
<b>0940 2712</b>	20 mm	260 mm	1	<b>15,25</b>

RUEDA CARRETILLA ALMACÉN NEUMÁTICA SIN RODAMIENTO / ROUE BROUETTE MAGASIN PNEUMATIQUE SANS ROULEMENT  
WAREHOUSE WHEELBARROW PNEUMATIC TYRE WITHOUT BEARING / RUOTA PNEUMATICA PER CARRELLO SENZA CUSCINETTO  
RODA PNEUMÁTICA P/ CARRINHO DE MÃO ARMAZÉM S/ ROLAMENTO



Ref				
<b>0940 2713</b>	20 mm	260 mm	1	<b>8,50</b>

RUEDA CARRETILLA ALMACÉN IMPINCHABLE SIN RODAMIENTO / ROUE BROUETTE MAGASIN INCREVABLE SANS ROULEMENT  
WAREHOUSE WHEELBARROW UNBREAKABLE TYRE WITHOUT BEARING / RUOTA PNEUMATICA IMPERFORABILE PER CARRELLO SENZA CUSCINETTO  
RODA ANTI-FURO P/ CARRINHO DE MÃO ARMAZÉM S/ ROLAMENTO



Ref				
<b>0940 2714</b>	20 mm	260 mm	1	<b>14,75</b>



JUEGO 2 COJINETES PARA CARRETILLA / JEU 2 COUSSINETS POUR BROUETTE / 2 BEARING SET FOR WHEELBARROW  
2 CUSCINETTI SUPPORTO RUOTA PER CARRIOLA / JOGO DE 2 ROLAMENTOS PARA CARRINHO DE MÃO



Ref	EJE		
0940 2700	20 mm	1	2,50

RUEDA GIRATORIA ANDAMIO C/FRENO / ROUE GIRATOIRE PLATE-FORME AVEC FREIN / REVOLVING WHEEL FOR SCAFFOLDING WITH BRAKE  
RUOTA ROTANTE PERNO CON FRENO / RODA GIRATÓRIA PARA ANDAIME C/ FREIO

TUBO HEMBRA  
TUBE FEMELLE  
FEMALE TUBE  
PERNO FEMMINA  
TUBO FÊMEA



TUBO MACHO  
TUBE MALE  
MALE TUBE  
PERNO MASCHIO  
TUBO MACHO



Ref			
0940 2750	200 x 50 mm	1	27,82
0940 2751	200 x 50 mm	1	27,14

GRAPADORAS / AGRAFEUSE / STAPLER / PINZATRICE / AGRAFADOR

GRAPADORA MANUAL ESTÁNDAR / AGRAFEUSE MANUELLE STANDARD / HAND STAPLER  
PINZATRICE MANUALE STANDARD / AGRAFADOR MANUAL STANDARD

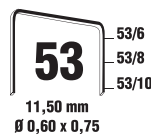

Ref			
0900 2001	1	8	17,25

GRAPADORA CLAVADORA MANUAL / AGRAFEUSE CLOUEUSE MANUELLE / MANUAL STAPLER NAILING MACHINE  
PINZATRICE CHIODATRICE MANUALE / AGRAFADOR PREGADOR MANUAL

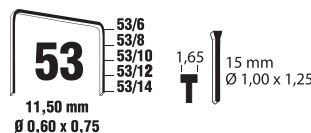

Ref			
0900 2002	1	8	24,58



GRAPADORA CLAVADORA / AGRAFEUSE CLOUEUSE / STAPLER NAILER / PINZATRICE CHIODATRICE / AGRAFADOR PREGADOR

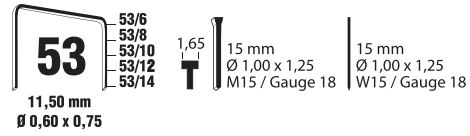

Ref			
0900 2003	1	10	45,86

GRAPADORA MANUAL DÚO / AGRAFEUSE MANUELLE DUO / HAND STAPLER DUO / PINZATRICE MANUALE DUO / AGRAFADOR MANUAL DUO

DÚO

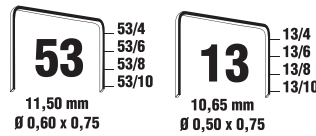

Ref			
0900 2004	1	10	38,44

GRAPADORA MANUAL PROFÍ DÚO / AGRAFEUSE MANUELLE PROFÍ DUO / HAND STAPLER PROFÍ DUO / PINZATRICE MANUALE PROFÍ DUO / AGRAFADOR MANUAL PROFÍ DUO

METAL



PROFESIONAL / DÚO

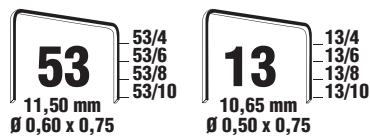

Ref			
0900 2005	1	10	50,45

GRAPADORA CLAVADORA PROFÍ / AGRAFEUSE CLOUEUSE PROFÍ / STAPLER NAILER PROFÍ / PINZATRICE CHIODATRICE PROFÍ / AGRAFADOR PREGADOR PROFÍ

METAL



PROFESIONAL



Ref			
0900 2006	1	5	75,60





GRAPADORA CLAVADORA ELÉCTRICA / AGRAFEUSE CLOUEUSE ELECTRIQUE / ELECTRIC STAPLER NAILER  
PINZATRICE CHIODATRICE ELETTRICA / AGRAFADOR PREGADOR ELÉTRICO

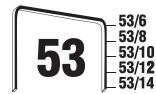

11,50 mm  
Ø 0,60 x 0,75

220 - 240 V  
~50/60 Hz



Ref			
0900 2007	1	6	113,57

CAJAS DE GRAPAS / BOITE D'AGRAFES / STAPLES BOX / CONFEZIONI GRAFFETTE / CAIXAS DE GRAMPOS

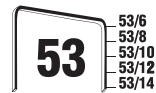

11,50 mm  
Ø 0,60 x 0,75

Ref	MODEL					
0900 2050	53	6 mm	5000 pcs	1	28	8,95
0900 2051	53	8 mm	5000 pcs	1	24	9,17
0900 2052	53	10 mm	5000 pcs	1	16	9,15
0900 2053	53	12 mm	5000 pcs	1	16	10,48
0900 2054	53	14 mm	5000 pcs	1	6	11,14

BLÍSTER DE GRAPAS / BLISTER D'AGRAFES / STAPLES BLISTER / BLISTER GRAFFETTE / BLISTER DE GRAMPOS



11,50 mm  
Ø 0,60 x 0,75

Ref	MODEL						
0900 2050B	53	6 mm	1960 pcs	1	15	5,46	✓
0900 2051B	53	8 mm	1960 pcs	1	15	5,46	✓
0900 2052B	53	10 mm	1120 pcs	1	15	5,46	✓
0900 2053B	53	12 mm	980 pcs	1	15	5,64	✓
0900 2054B	53	14 mm	840 pcs	1	15	5,64	✓

BLÍSTER DE CLAVOS / BLISTER DE CLOUS / NAILS BLISTER / BLISTER CHIODI / BLISTER DE PREGOS



Con Cabeza / With head

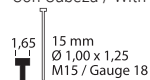

Ref						
0900 2060B	M-15 mm	1700 pcs	1	15	6,39	✓

Sin Cabeza / Without head

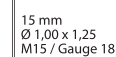

Ref						
0900 2061B	W-15 mm	2000 pcs	1	15	6,39	✓



PISTOLA COLA TERMOFUSIBLE / PISTOLET COLLE THERMOFUSIBLE / GLUE GUN THEMOFUSE  
PISTOLA TERMOCOLLANTE / PISTOLA COLA TERMO-FUSÍVEL

Bricofan



CE

30W  
220 - 240 V  
~50 Hz

Ref	Ø	W			
0900 2100	12 mm	30 W	1	10	12,24

PISTOLA COLA TERMOFUSIBLE / PISTOLET COLLE THERMOFUSIBLE / GLUE GUN THEMOFUSE  
PISTOLA TERMOCOLLANTE / PISTOLA COLA TERMO-FUSÍVEL



CE

40W - 60W

Ref	Ø	W			
0900 2101	12 mm	40 W	1	10	15,77
0900 2102	12 mm	60 W	1	6	19,06

BARRAS DE PEGAMENTO TERMOFUSIBLE / BARRAS DE COLA TERMOFUSIBLE / GLUE GUN THEMOFUSE STICK  
STICK DI COLLA TERMOFUSIBILE / BASTÕES DE COLA TERMO-FUSÍVEL

TRANSPARENTE  
TRANSPARENT



Ref		Ø	↔			
0900 2105	1 kg	12 mm	200 mm	1	10	16,60
0900 2105B	280 g	12 mm	200 mm	1	10	7,64





	ES	FR	EN	IT	PT
<b>Ref</b>	Referencia	Référence	Reference	Riferimento	Referência
	Altura cerrada	Hauteur fermée	Closed height	Altura fechada	Chiusura altezza
	Peldaños	Étapes	Steps	Degraus	Gradini
<b>Kg↓</b>	Carga máxima	Charge maximum	Maximum load	Carga máxima	Carico massimo
	Peso	Poids	Weight	Peso	Peso
	Precio	Prix	Price	Prezzo	Preço
<b>H max</b>	Altura máxima	Hauteur maximum	Maximum height	Altura máxima	Altezza massima
	Altura de trabajo	Hauteur de travail	Work height	Altura de trabalho	Altezza di lavoro
	Altura de plataforma	Hauteur de plateforme	Platform height	Altura da plataforma	Altezza piattaforma
	Ancho	Largeur	Width	Larghezza	Largura
	Cerrada	Fermée	Closed	Fechada	Chiusura
	Andamio	Plate-forme	Scaffold	Andaime	Ponteggio
	Tijera	Ciseaux	Scissor	Tesoura	Forbice
	Extensible	Extensible	Extendible	Estensibile	Extensível
	Con respaldo	Avec dossier	Backrest	Con schienale	Extensível
	Medidas	Mesures	Measurements	Misure	Medidas
	Colores	Couleur	Color	Colore	Cores
<b>CAP</b>	Capacidad	Capacité	Capacity	Capacidade	Capacità
<b>H min</b>	Altura mínima	Hauteur minimum	Minimum height	Altezza minima	Altura mínima
	Ruedas delanteras	Roues avants	Front wheels	Ruota anteriore	Rodas dianteiras
	Ruedas traseras	Roues arrières	Back wheels	Ruota posteriore	Rodas traseiras
	Posiciones	Positions	Positions	Posizioni	Posições
	Mango	Manche	Handle	Manico	Cabo/Punho
	Ruedas	Roues	Wheels	Rodas	Ruote
	Almohadilla	Rembourree	Pads	Almofada	Rivestimento
	Compartimentos	Compartiments	Sections	Compartimenti	Compartimentos
	Unidad mínima de venta	Nombre d'unités minimum de vente	Minimum sale unit	Quantitativo minimo di vendita	Unidade mínima de venda
<b>M</b>	Métrica	Métrique	Metrical	Metrica	Métrica
	Descripción	Description	Description	Descrizione	Descrição
	Packing	Conditionnement	Packing	Imballo	Embalagem
<b>MODEL</b>	Modelo	Modèle	Model	Modello	Modelo
	Longitud	Longueur	Length	Lunghezza	Comprimento
	Altura	Hauteur	Height	Altezza	Altura
	Contenido	Contenu	Contains	Contenuto	Inclui
	Carraca	Cliquet	Ratchet	Cricchetto	Roquete
	Huella plano	Empreinte plate	Slotted tip	Testa piatta	Ponta fenda
	Huella Robertson	Empreinte Robertson	Robertson tip	Testa Robertson	Ponta Robertson
	Huella allen	Empreinte allen	Allen tip	Testa allen	Ponta allen
	Huella allen inviolable	Empreinte allen inviolable	Allen, tamper resistance tip	Testa allen inviolabile	Ponta allen com furo
	Huella Pozidrive	Empreinte Pozidrive	Pozidrive tip	Testa Pozidrive	Ponta Pozidrive
	Huella Phillips	Empreinte Phillips	Phillips tip	Testa Phillips	Ponta Phillips
	Huella torx	Empreinte torx	Torx tip	Testa torx	Ponta torx
	Huella torx inviolable	Empreinte torx inviolable	Torx, tamper resistance tip	Testa torx inviolabile	Ponta torx com furo
	Huella T. wing	Empreinte T. wing	Pozidrive T. wing	Testa T. wing	Ponta T, wing
	Huella T-set	Empreinte T-set	Pozidrive T-set	Testa T-set	Ponta T-set
	Huella XZN extra	Trace XZN supplémentaire	XZN Extra mark	Marca extra XZN	Punta extra XZN
	Huella triple aleta	Empreinte triple	Tri Wings tip	Testa tre punte	Ponta tripla ala
	Huella Spanner	Empreinte Spanner	Spanner tip	Testa Spanner	ponta Spanner
	Cuadradillo, cuadrado	Entrées	Socket entrance	Ingresso becco	Tomada de entrada
	Blíster	Blister	Blister	Blister	Blister



	ES	FR	EN	IT	PT
	Medida cuña o vástago	Measure piston	Measurement of working part	Misura punta	Medida da haste
	Longitud destornillador	Longueur tournevis	Screwdriver length	Lunghezza cacciavite	Comprimento da chave de fendas
	Punta destornillador	Pointe tournevis	Screwdriver bit	Punta cacciavite	Ponta da chave de fendas
	Reversible	Réversible	Reversible	Reversibile	Reversível
	Voltaje	Voltage	Voltage	Voltaggio	Voltagem
	Corte	Coupe	Cut	Taglio	Corte
	Apertura	Ouverture	Opening	Apertura	Abertura
	Diámetro	Diamètre	Diameter	Diametro	Diâmetro
	Boca	Bouche	Nose	Becco	Boca
	Ángulo Corte	Angle de coupe	Cut angle	Angolo taglio	Ângulo de corte
	Material	Matériel	Material	Materiale	Material
<b>TPI</b>	TPI	TPI	TPI	TPI	TPI
	Medida hoja navaja	Measure lame	Blade Measure	Misura lama	Medida da lâmina da navalha
	Medida navaja cerrada	Measure lame fermée	Measure of closed Penknife	Misura manico	Medida navalha fechada
	Recambio para martillo	Pièce de rechange pour marteau	Hammer Spare part	Ricambio per martelli	Reposição para martelo
	Apertura llave, SW max	Ouverture clé, SW max	Wrench opening, max SW	Apertura chiave, SW Max	Abertura da chave, SW max
<b>Nm</b>	Nm	Nm	Nm	Nm	Nm
<b>SW</b>	SW	SW	SW	SW	SW
<b>H</b>	Hembra	Femelle	Female	Femmina	Fêmea
<b>M</b>	Macho	Male	Male	Maschio	Macho
	Hembra	Femelle	Female	Femmina	Fêmea
	Macho	Male	Male	Maschio	Macho
<b>OUT N.M.</b>	Out N. M.	Out N. M.	Out N. M.	Out N. M.	Out N. M.
<b>RATIO</b>	Ratio	Ratio	Ratio	Ratio	Rapporto
	Número de dientes, Dientes	Nombre de dents, dents	Number of teeth, Teeth	N° denti	Número de dentes
	Grosor, espesor	Grosueur, épaisseur	Thickness	Spessore o larghezza	Grossura, espessura
<b>ADAP</b>	Adaptable específico	Adaptable spécifique	Specific adaptable	Specificamente adattabile	Específico adaptável
	Número de filas, cepillo	Nombre de files rabot	Number of lines, Brush	N° file spazzole	Número de filas, escovas
	Hojas (galgas de espesores)	Feuilles (jauges d'épaisseurs)	Lenghts (feeler gauges)	Lamine (spessimetri)	Folhas (calibradores de espessuras)
<b>mm</b>	Rango mm	Rang mm	Range mm	Rangoe mm	Range mm
<b>Inch</b>	Rango inch	Rang inch	Range inch	Rangoe inch	Range inch
<b>W</b>	Vatios	Watts	Watts	Watts	Watt
<b>°C</b>	Temperatura	Température	Temperature	Temperatura	Temperatura
	Longitud de la cerda	Longueur des poiles	Length of bristles	Lunghezza dei setole	Comprimento da cerda
	Ancho rueda	Largeur de la roue	Wheel wide	Larghezza ruota	Largura da roda
	Eje	Axe	Axis	Asse	Eixo
	Diámetro de la rueda	Diamètre de la roue	Wheel diameter	Diametro della ruota	Diâmetro da roda
	Medidas de la placa	Mesures de la plaque	Plaque measurements	Misure della placca	Medidas da placa
	Medidas ejes taladros	Mesures axes des forets	Drills' axis measurements	Misura fori	Medidas eixos perfuração
	Diámetro del taladro de la placa	Diamètre du foret de la plaque	Plaque drill diameter	Diametro punta placca	Miâmetro de perfuração da placa
	Medida del tornillo pasante 2	Measure de la vis pasante 2	Through screw's 2 measurement	Misura della vite forante 2	Medida do parafuso interno 2
	Altura desde la placa al suelo	Hauteur depuis la plaque au sol	Height from the plaque to the floor	Altezza dal piano al suolo	Altura da placa ao chão
	Medida desde el freno hasta el eje	Measure depuis le frein jusqu'à l'axe	Measure from the break to the axis	Misura dal freno all'asse	Medida do freio até ao eixo
	Medida del tornillo pasante	Measure de la vis pasante	Through screw's measurement	Misura della vite forante	Misura della vite forante
	Ancho rueda	Largeur de la roue	Wheel wide	Larghezza ruota	Largura da roda





cofan



[www.cofan.es](http://www.cofan.es)



# ÍNDICE / INDEX / CONTENTS

## INDICE / ÍNDICE



**244**

COMPRESORES DE AIRE / COMPRESSEURS D'AIR  
AIR COMPRESSOR / COMPRESSORE AD ARIA  
COMPRESSORES DE AR



**247**

REMACHADORAS / RIVETEUSES / RIVETERS  
RIVETTATRICI / REBITADORES



**246**

FRESADORAS / MEULEUSE / DIE GRINDER  
FRESATRICE / FRESADORAS



**249**

PISTOLAS DE IMPACTO / CLÉS À CHOC  
AIR IMPACT WRENCH / CHIAVE A PERCUSSIONE  
CHAVE DE IMPACTO



**246**

AMOLADORAS / MEULEUSES / ANGLE GRINDERS  
FRESATRICE / MOEDORES



**251**

PISTOLAS DE SOPLAR / PISTOLET A AIR / AIR DUSTER  
PISTOLE AD ARIA / PISTOLAS DE AR



**246**

TALADRO / PERÇEUSE / AIR DRILL  
TRAPANO / BERBEQUIM



**252**

PISTOLAS DE PINTAR / PISTOLET A AIR / AIR DUSTER  
PISTOLE PER VERNICI / PISTOLA DE PINTAR



**247**

CONJUNTO ESCARPA / COFFRET CISELEUR  
AIR HAMMER KIT / SCALPELLO  
CONJUNTO MARTELO



**253**

SIERRA NEUMÁTICA / SCIE PNEUMATIQUE  
AIR BODY SAW / SEGA PNEUMATICA  
SERRA PNEUMÁTICA



**253**

ATORNILLADORES / VISSEUSE / PEIC SCREWDRIVERS  
AVVITATORI LINEARI / CHAVES DE FENDAS



**259**

ENCHUFES RÁPIDOS / RACCORDS RAPIDES  
AIR QUICK COUPLER / PRESE RAPIDE  
ACOPLADORES RÁPIDOS



**254**

CLAVADORAS NEUMÁTICAS / PISTOLET PNEUMATIQUE  
AIR NAILERS / CHIODATRICI PNEUMATICHE  
PREGADORES PNEUMÁTICOS



**263**

RACORERÍA DE PLÁSTICO / RACCORDS PLASTIQUES  
PLASTIC FITTINGS / RACCORDI IN PLASTICA  
ENCAIXES DE PLÁSTICO



**256**

ACCESORIOS NEUMÁTICA / ACCESSOIRES PNEUMATIQUE  
ACCESSORIES / ACCESSORI PNEUMATICI  
ACESSÓRIOS PNEUMÁTICA



**268**

RACORERÍA METÁLICA / RACCORDS METALLIQUES  
METALLIC FITTINGS / RACCORDERIA METALLICA  
ACESSÓRIOS METÁLICOS



**257**

MANGUERAS / FLEXIBLES A AIR / HOSES  
TUBI / MANGUEIRAS



**293**

TUBERÍAS DE POLIAMIDA / FLEXIBLES DE POLYAMIDE  
POLYAMIDE TUBES / TUBI IN POLIAMMIDE  
TUBOS POLIAMIDA



**258**

FILTROS DE AIRE / FILTRES A AIR / AIR FILTERS  
FILTRI ARIA / FILTROS DE AR



**296**

GLOSARIO / GLASSAIRE / GLOSSARY  
FLOSSARIO / GLOSSÁRIO



COMPRESORES DE AIRE / COMPRESSEURS D'AIR / AIR COMPRESSOR / COMPRESSORE AD ARIA / COMPRESSORES DE AR

World Brand. Energy Value ISO-9001 CE

ES Sin aceite, lo que equivale a libre de mantenimiento. Para aplicaciones tanto de bricolaje como de uso profesional. Aluminio con cubierta de hierro.

FR Sans huile, ce qui veut dire sans entretien. Pour du bricolage ou pour une utilisation professionnelle. Aluminium avec couverture de fer.

EN Oil-less means maintenance-free. For D.I.Y. and professional applications. Die Cast aluminium with cast iron sleeve.

IT Senza olio, il che significa assenza di manutenzione. Disegno compatto e peso ridotto. Sia per utilizzo hobbistico che per uso professionale. In alluminio con rivestimento in acciaio.

PT Sem óleo, o equivalente a livre manutenção. Para ambas as aplicações, bricolage e uso profissional. Alumínio revestido de ferro.



LIBRES DE MANTENIMIENTO / SANS ENTRETIEN / MAINTENANCE - FREE  
LIBRETTO DI MANUTENZIONE / LIVRES DE MANUTENÇÃO

1/2" HP  
220 V / 50 Hz  
6 Litros

Ref	HP	rpm								
0900 1001	1/2	2850 rpm	34 l/min	8 kg/cm	10 kg/cm	6 L	8,6 kg	45x20x42 cm	1	346,02



LIBRES DE MANTENIMIENTO / SANS ENTRETIEN / MAINTENANCE - FREE  
LIBRETTO DI MANUTENZIONE / LIVRES DE MANUTENÇÃO

1/5" HP  
220 V / 50 Hz  
12 Litros

Ref	HP	rpm								
0900 1002	1/5	2850 rpm	92 l/min	8 kg/cm	10 kg/cm	12 L	18,0 kg	53x29x55 cm	1	391,25



LIBRES DE MANTENIMIENTO / SANS ENTRETIEN / MAINTENANCE - FREE  
LIBRETTO DI MANUTENZIONE / LIVRES DE MANUTENÇÃO

2/0" HP  
220 V / 50 Hz  
25 Litros

Ref	HP	rpm								
0900 1003	2/0	2850 rpm	108 l/min	8 kg/cm	10 kg/cm	25 L	25,0 kg	60x29x66 cm	1	459,51





COMPRESOR LUBRICADO / COMPRESSEUR LUBRIFIÉ / OILED COMPRESSOR / COMPRESSORE LUBRIFICATO / COMPRESSOR LUBRIFICADO

**MOD. AUSTRO**

**2/0" HP**  
**230 V / 50 Hz**  
**24 Litros**



ES Compresor de pistón coaxial lubricado con transmisión directa, 2 HP, presión máxima 8 bares a 2850 r.p.m. Monofásico 230 v, con depósito de 24 litros y botón on/off. Aire aspirado 222 litros/min.

FR Compresseur piston coaxial lubrifié avec transmission directe, 2 CV, pression maximum 8 bars à 2850 r.p.m. Monophasé 230 v, avec réservoir 24 litres et bouton on/off. Air aspiré 222 litres/min.

EN Oiled valved coaxial compressor with direct transfer. 2HP, maximum pressure 8 bars / 2850 rpm. Single phase 230v. 24 litres tank. On/off button. Drawn-in air 222 litres/min.

IT Compresore a pistone coassiale lubrificato con azionamento diretto, 2HP, pressione massima 8 bar a 850 rpm. Monofase 230V, con deposito da 24 litri e pulsante on/off. Aria aspirata 222 litri/min.

PT Compresor de pistão coaxial lubrificado com transmissão direta, 2 HP, pressão máxima de 8 bar a 2850 r.p.m. Monofásico 230 v, com tanque de 24 litros e botão no/off. Ar aspirado 222 litros/min.

Ref	HP	rpm								
0900 1010	2/0	2850 rpm	190 l/min	8 kg/cm	10 kg/cm	24 L	24 kg	61x31x580 cm	1	247,42

**MOD. HAVA**

**2/0" HP**  
**230 V / 50 Hz**  
**50 Litros**



ES Compresor de pistón coaxial lubricado con transmisión directa, 2 HP, presión máxima 8 bares a 2850 r.p.m. Monofásico 230 v, con depósito de 50 litros y botón on/off. Aire aspirado 222 litros/min.

FR Compresseur piston coaxial lubrifié avec transmission directe, 2 CV, pression maximum 8 bars à 2850 r.p.m. Monophasé 230 v, avec réservoir 50 litres et bouton on/off. Air aspiré 222 litres/min.

EN Oiled valved coaxial compressor with direct transfer. 2HP, maximum pressure 8 bars / 2850 rpm. Single phase 230v. 50 litres tank. On/off button. Drawn-in air 222 litres/min.

IT Compresore a pistone coassiale lubrificato con azionamento diretto, 2HP, pressione massima 8 bar a 850 rpm. Monofase 230V, con deposito da 50 litri e pulsante on/off. Aria aspirata 222 litri/min.

PT Compresor de pistão coaxial lubrificado com transmissão direta, 2 HP, pressão máxima de 8 bar a 2850 r.p.m. Monofásico 230 v, com tanque de 50 litros e botão no/off. Ar aspirado 222 litros/min.

Ref	HP	rpm								
0900 1011	2/0	2850 rpm	190 l/min	8 kg/cm	10 kg/cm	50 L	28 kg	77x43x660 cm	1	319,44



FRESADORA NEUMÁTICA / MEULEUSE PNEUMATIQUE / PNEUMATIC DIE GRINDER / FRESATRICE PNEUMATICA / FRESADORA PNEUMÁTICA



1/4" - 6 mm

Ref	rpm						
0900 0701	22.000 rpm	6,5 bar	8 x 12	1/4"	226 l/min	1	74,88

FRESADORA NEUMÁTICA / MEULEUSE PNEUMATIQUE / PNEUMATIC DIE GRINDER / FRESATRICE PNEUMATICA / FRESADORA PNEUMÁTICA



90°  
1/4" - 6 mm

ES Fresadora de alto rendimiento. Especial para trabajos de difícil acceso. Ideal para utilizar abrasivos, barras de pulido y fresas metálicas. Herramienta ligera, manejable con engranaje cónico espiral. Incorpora regulación de velocidad en el mando.

FR Meuleuse à rendement élevé. Pratique lors d'accès difficiles. Engrenage conique spiral. Légère et maniable. Contrôle de vitesse par la gachette.

EN High performance tool. Specially for works with difficult reach of access. Ideal to work with abrasives and rotary burrs. Light tool, easy to use. Speed controller drive in the handle.

IT Fresatrice ad alto rendimento. Pratica per utilizzi in punti ad accesso difficoltoso. Ideale per l'utilizzo di abrasivi, spazzole per la pulizia e frese metalliche. Attrezzatura leggera, maneggevole, con ingranaggio conico a spirale. Regolazione della velocità tramite leva di azionamento.

PT Fresadora pneumática de rendimento elevado. Especial para trabalhos de difícil acesso. Ideal para usar abrasivos, barras de polimento e fresas metálicas. Ferramenta leve, prática, com engrenagem cônica espiral. Inclui controle de velocidade no comando.

Ref	rpm						
0900 0710	18.000 rpm	6,5 bar	8 x 12	1/4"	184 l/min	1	115,44

AMOLADORAS NEUMÁTICAS / MEULEUSES PNEUMATIQUES / ANGLE GRINDERS  
FRESATRICE PNEUMATICA / MOEDORES PNEUMÁTICOS

AMOLADORA NEUMÁTICA PARA DISCOS DE CORTE O DESBASTE / MEULEUSE PNEUMATIQUE POUR DISQUES DE COUPE OU DE POLISSAGE  
ANGLE GRINDER USEFUL FOR CUTTING OR POLISHING DISKS / FRESATRICE PNEUMATICA PER DISCHI DI TAGLIO O RIFINITURA  
MOEDOR PNEUMÁTICO PARA DISCOS DE CORTE OU DESBASTE



Ø115 / 125 mm

Ref	rpm						
0900 0750	11.000 rpm	6,5 bar	115 / 125 x 22,2 mm	1/4"	212 l/min	1	233,53

TALADRO NEUMÁTICO / PERÇEUSE PNEUMATIQUE / AIR DRILL  
TRAPANO PNEUMATICO / BERBEQUIM PNEUMÁTICO

TALADRO NEUMÁTICO REVERSIBLE / PERÇEUSE PNEUMATIQUE REVERSIBLE / REVERSIBLE AIR DRILL  
TRAPANO PNEUMATICO REVERSIBILE / BERBEQUIM PNEUMÁTICO REVERSÍVEL



ES Taladro neumático reversible (giro izquierda-derecha). Control de velocidad en el gatillo.

FR Perçeuse pneumatique réversible (droite-gauche). Contrôle de vitesse par la gachette.

EN Reversible air drill (left-right rotation). Speed controller trigger.

IT Trapano pneumatico reversibile (rotazione oraria/antioraria). Regolazione della velocità.

PT Berbequim pneumático reversível (rotação esquerda-direita). Controle da velocidade no gatilho.

Ref	rpm						
0900 0201	2.300 rpm	6,5 bar	1 - 10 mm	1/4"	283 l/min	1	145,70



CONJUNTO ESCARPA NEUMÁTICA / COFFRET CISELEUR PNEUMATIQUE / AIR HAMMER KIT  
SCALPELLO PNEUMATICO / CONJUNTO MARTELO PNEUMÁTICO



ES Escarpa neumática, es posible ajustar la fuerza del golpe mediante la regulación de la presión de aire. Herramienta ideal para realizar todos los trabajos en carrocería. Cinceles de acero especial, con gran duración en trabajos exigentes. Ergonómica y fácil de transportar gracias al maletín suministrado.

FR Possibilité d'ajuster la force du coup par le réglage de la pression de l'air. Outil idéal pour travaux de carrosserie. Ciseaux en acier spécial, conçus pour durer même en usage intensif. Ergonomique, coffret utile pour le transport.

EN Air hammer, possibility of changing power by setting air regulator. Ideal for working on bodywork. Special steel chisels, long-lasting. Ergonomic and easy to carry because of its case.

IT Scalpello pneumatico, è possibile regolare la forza dell'impatto mediante la regolazione della pressione dell'aria. Attrezzatura ideale per i lavori di carrozzeria. Utensili in acciaio speciale, ad alta durata in utilizzo gravoso. Ergonomica e facile da trasportare grazie alla valigetta fornita.

PT Cínel pneumático, possibilidade de definir a força do golpe através da pressão do ar. ideal para trabalhar em carroceria. Cíneis de aço especial, de longa duração. Ergonómico, fácil de transportar devido à maleta fornecida.

Ref								
0900 0401	6,5 bar	8 x 12	1/4"	283 l/min	1,60 kg	3.000	1	113,88

M	Ref			
1	0900 0402	CINCEL PUNTOS SOLDADURA / POINCON SOUDURE / TAPERED PUNCH CESELLO A PUNTA / CINZEL CÓNICO	1	5,56
2	0900 0403	CINCEL PLANO / POINCON PLAT / FLAT CHISEL CESELLO PIATTO / CINZEL PLANO	1	5,56
3	0900 0404	CINCEL ROMPEDOR / POINCON CASSANT / EDGING TOOL CESELLO ROTTURA / CINZEL ROMPEDOR	1	5,90
4	0900 0405	CINCEL SEPARADOR CHAPA / POINCON SÉPARATEUR PLAQUE / TAILPIPE CUTTER CESELLO SEPARATORE / CINZEL DE SEPARAÇÃO	1	6,72
5	0900 0406	CINCEL TENAZA / POINCON TENAILLE / PINCER CHISEL CESELLO TENAGLIA / CINZEL TIPO PINÇA	1	6,72

M	Ref			
1	0976 0500	MUELLE ESCARPA / RESSORT CISELEUR / RETAINER SPRING MOLLA SCALPELLO / MOLA RETENTORA	1	3,59
2	0976 0501	RETENEDOR DE CINCELES / RESSORT P. RECH. POINCONS / QUICK CHANGE RETAINER MOLLA AMMORTIZANTE / RETENTOR DE CINZÉS	1	17,94

REMACHADORAS NEUMÁTICAS / RIVETEUSES PNEUMATIQUES / AIR HYDRAULIC RIVETERS  
RIVETTATRICE PNEUMATICH / REBITADORES PNEUMÁTICOS

KIT REMACHADORA NEUMÁTICA / KIT RIVETEUSE PNEUMATIQUE / AIR HYDRAULIC RIVETER KIT  
KIT RIVETTATRICE PNEUMATICA / KIT REBITADOR PNEUMÁTICO



ES Remachadora neumática con mecanismo interior hidráulico y sistema estanco de larga vida útil. Para remaches de 2.4 hasta 5 mm. Maletín incluye boquillas, mordazas de recambio, aceite lubricante, llaves para desmontar y kit de limpieza.

FR Riveteuse pneumatique avec mécanisme hydraulique. Pour rivets de 2.4 à 5 mm. Coffret avec adaptateurs, mâchoires de rechange, lubrifiant, clés de démontage et kit de nettoyage.

EN Hydraulic mechanism, high security lever throttle, long-life system. For rivets from 2.4 to 5 mm. The kit contains hermetic seals, jaws, lubricant oil, keys for dismantling and cleaning kit.

IT Rivettatrice pneumatica con meccanismo idraulico di lunga durata. Per chiodi da 2,4 a 5 mm, la valigetta include adattatori, pinze di ricambio, olio lubrificante, chiave di smontaggio e kit di pulizia.

PT Rebitador pneumático com mecanismo interior hidráulico e sistema de vedação de longa vida útil. Para rebites de 2.4 até 5 mm. A maleta inclui bicos, garras de substituição, óleo lubrificante, chaves para desmontar e um kit de limpeza.

Ref							
0900 0501	2,4-5 mm	6,5 bar	8 x 12	1/4"	184 l/min	1	195,73



## ROCKING DOG HAMMER SYSTEM

### ES Características:

Martillo simple para herramienta de impacto, excelente apriete. Fácil de mantener. Disponible con mando de regulación. Recomendado para talleres de automoción.

### FR Caractéristiques:

Marteau simple pour outil à choc, excellent serrage. Facile à tenir. Disponible avec manche réglable de règlement. Recommandé pour les ateliers automobiles.

### EN Features:

Single-hammer action type impact wrenches deliver an excellent torque to weight ratio. Simple to maintain. Available with regular anvil. Recommended for servicing applications in automotive garages.

### IT Caratteristiche:

Avvitatore ad impulso. Ad alta potenza. Ottimo rapporto peso-potenza. Facile da mantenere. Disponibile con manopola di regolazione. Raccomandato per autofficine.

### PT Características:

Martelo simples para ferramenta de impacto, aperto excelente. Simples de manter. Disponível com comando de regulação. Recomendado para garagens de automóveis.

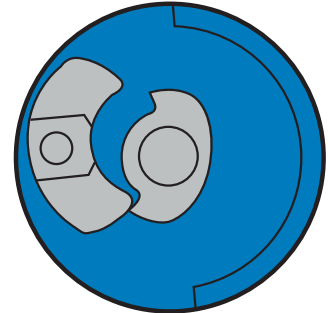

## PIN CLUTCH HAMMER SYSTEM

### ES Características:

PIN CLUTCH está diseñado para una rápida progresión del par de apriete. Diseñado para industria y PARA TRABAJOS DE MECÁNICA RÁPIDA. Por su amplio rango de apriete muy apropiada para diversas aplicaciones industriales.

### FR Caractéristiques:

PIN CLUTCH est conçu pour une progression rapide du couple de serrage. Conçu pour l'industrie et POUR LES TRAVAUX MECANIQUE RAPIDES. Recommandé pour accomplir de nombreuses tâches dans le domaine industriel.

### EN Features:

The PIN CLUTCH Mechanism is designed for a fast torque progression. Designed for heavy industry applications & HIGH SPEED PROCESS LINES. Each tool has a wide torque range to suit many applications.

### IT Caratteristiche:

Il sistema PIN CLUTCH è stato progettato per una rapida progressione della coppia. Progettato per applicazioni industriali e PER RAPIDI INTERVENTI MECCANICI. Grazie alla sua alta potenza è appropriato per soddisfare molte applicazioni industriali.

### PT Características:

O mecanismo de embreagem PIN foi concebido para um rápida progressão de binário. Projetado para a industriae para trabalhos de MECÂNICA RÁPIDA. Cada ferramenta tem uma ampla gama de binário para atender às diversas aplicações.

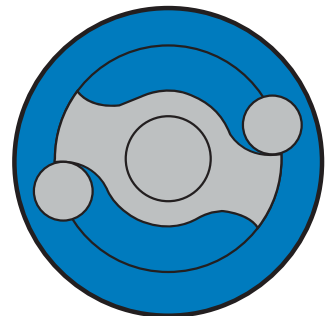

## TWIN HAMMER SYSTEM

### ES Características:

Doble martillo de impacto. MÁS POTENCIA QUE OTROS MECANISMOS DE IMPACTO. Fácil manejo, mantenimiento a bajo coste, alto rendimiento. NOTABLE incremento de potencia a través del selector de apriete, mejor que otras herramientas.

### FR Caractéristiques:

Double marteau à impact. PLUS DE PUISSANCE QUE D'AUTRES MÉCANISMES A IMPACT. Maniement facile, peu d'entretien, fort rendement. ACCROISSEMENT IMPORTANT de la puissance grâce au levier de serrage, mieux que d'autres outils.

### EN Features:

Twin hammer impact. MORE POWER PER POUND THAN OTHER IMPACT SYSTEMS. Operation easy, low-cost maintenance, performs well. MORE SENSITIVE to air pressure regulation than any other tools.

### IT Caratteristiche:

Doppio martello ad impatto. POTENZA SUPERIORE RISPETTO AGLI ALTRI SISTEMI AD IMPULSO. Facile da usare, basso costo di manutenzione, alto rendimento. SENSIBILE incremento della potenza. Migliore degli altri strumenti.

### PT Características:

Duplo martelo de impacto. MAIS POTÊNCIA DO QUE OUTROS MECANISMOS DE IMPACTO. Fácil de USAR, manutenção a baixo custo, bom desempenho. AUMENTO significativo de potência através do seletor de binário, melhor do que outras ferramentas.

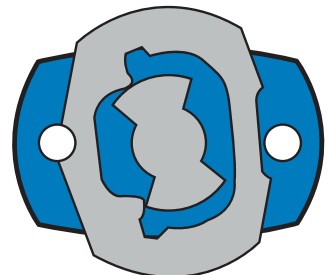



PISTOLA DE IMPACTO 3/8" / CLE A CHOCS 3/8" / 3/8" AIR IMPACT WRENCH / CHIAVE A PERCUSSIONE 3/8" / CHAVE DE IMPACTO 3/8"

3/8"



ES Herramienta de impacto con mecanismo antivibratorio. Mando con giro derecha e izquierda. Fácil manejo con una sola mano.

FR Mécanisme antivibrations, couple de serrage élevé. Réversible droite-gauche. Utilisation facile d'une seule main.

EN Impact tool with anti-vibratory mechanism. Left-right rotation drive. Easy to work with only one hand.

IT Chiave a percussione con meccanismo antivibrante, della coppia massima. Comando con rotazione destra e sinistra. Maneggio con una sola mano.

PT Mecanismo anti-vibratório. Unidade de rotação Esquerda-Direita. Fácil para trabalhar com uma só mão

Ref	rpm	kg	bar	in	in	l/min	(N)		
0900 0130	9.500 rpm	1,14 kg	6,5 bar	3/8"	1/4"	241 l/min	169 (N)	1	121,58

PISTOLA DE IMPACTO 1/2" / CLE A CHOCS 1/2" / 1/2" AIR IMPACT WRENCH / CHIAVE A PERCUSSIONE 1/2" / CHAVE DE IMPACTO 1/2"

1/2"



ES Herramienta de impacto con mecanismo antivibración, elevado par de apriete y rápida formación del par máximo. Fácil manejo con una sola mano. Mecanismo de baño de aceite, lubricación permanente. Ergonómica, resistente, centro de gravedad y fácil manejo.

FR Outil à choc avec mécanisme antivibration couple de serrage élevé. Maniement facile avec une seule main. Mécanisme de bain d'huile, lubrification permanente. Ergonomique, résistant, centre de gravité et maniement facile.

EN Impact tool with anti-vibratory mechanism, high torque output and fast rundown. Easy to work with only one hand. Oil coated mechanism, permanent lubrication. Ergonomic, resistant and easy to use.

IT Chiave a percussione con meccanismo antivibrante, con elevate coppie di serraggio e rapido raggiungimento della coppia massima. Facile utilizzo con una sola mano. Meccanismo a bagno d'olio, lubrificazione permanente. Ergonomica, resistente, bilanciata e di facile utilizzo.

PT Ferramenta de impacto, com mecanismo anti-vibração, binário elevado e rápida formação de binário máximo. Fácil de usar com uma mão. Mecanismo de banho de óleo, lubrificação permanente. Ergonômica, durável, centro de gravidade e de fácil manuseio.

Ref	rpm	kg	bar	in	in	l/min	(N)		
0900 0120	7.000 rpm	2,94 kg	6,5 bar	1/2"	1/4"	340 l/min	542 (N)	1	247,85

MALETÍN PISTOLA DE IMPACTO 1/2" CON ACCESORIOS / VALISSETTE CLE A CHOC / 1/2" AIR IMPACT WRENCH CASE  
VALIGETTA CHIAVE A PERCUSSIONE 1/2" CON ACCESSORI / MALETA CHAVE DE IMPACTO 1/2"

1/2"

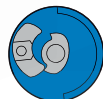

Ref	rpm	kg	bar	in	in	l/min	(N)		
0900 0121	7.000 rpm	4,45 kg	6,5 bar	1/2"	1/4"	382 l/min	311 (N)	1	145,80

CARRACA NEUMÁTICA 1/2" / CLIQUET PNEUMATIQUE 1/2" / 1/2" HEAVY DUTY RATCHET WRENCH  
CRICCHETTO PNEUMATICO 1/2" / CATRACATA PNEUMÁTICA 1/2"

1/2"



ES Mando giratorio derecha e izquierda. El par puede aumentarse efectuando giros manuales.

FR Réversible droite-gauche. Le couple peut être augmenté en effectuant manuellement des rotations.

EN Left-right rotation drive handle. Speed controller valve.

IT Selettore per rotazione oraria ed antioraria. La coppia può essere incrementata per mezzo di rotazioni manuali.

PT Comando giratório direita-esquerda e aumento do binário através de rotações manuais á ferramenta.

Ref	rpm	kg	bar	in	in	l/min	(N)		
0900 0151	160 rpm	1,25 kg	6,5 bar	1/2"	1/4"	241 l/min	82 (N)	1	128,03





**PISTOLA DE IMPACTO 3/4" / CLE A CHOC 3/4" / 3/4" AIR IMPACT WRENCH / CHIAVE A PERCUSSIONE 3/4" / CHAVE DE IMPACTO 3/4"**

**3/4"**



ES Herramienta de impacto con mecanismo antivibraciones, fácil manejo con una sola mano. Ergonómica, resistente, centro de gravedad y fácil funcionamiento.

FR Mécanisme antivibrations, couple de serrage élevé. Utilisation facile d'une seule main. Ergonomique, résistant, usage pratique.

EN Impact tool with anti-vibratory mechanism, easy to work with only one hand. Ergonomic, resistant and easy to use.

IT Chiave a percussione con meccanismo antivibrante. Ergonomica, resistente, bilanciata e di facile utilizzo.

PT Chave de impacto com mecanismo de antivibrações, fácil de manejar mesmo com uma mão. Ergonômico, resistente, centro de gravidade e fácil funcionamento.

Ref	rpm								
<b>0900 0110</b>	4.800 rpm	5,10 kg	6,5 bar	3/4"	1/4"	396 l/min	949 (N)	1	<b>397,60</b>

**PISTOLA DE IMPACTO 1" / CLE A CHOC 1" / 1" HEAVY AIR IMPACT WRENCH / CHIAVE A PERCUSSIONE 1" / CHAVE DE IMPACTO 1/2"**

**1"**



ES Pistola de impacto con regulación de potencia para fijación individual del par de apriete. Gatillo sensibilizado para una exacta regulación de revoluciones.

FR Clé à chocs avec réglage de puissance par sélection du couple de serrage. Gachettes sensibilisées par un réglage précis des rotations.

EN Impact tool wrench with power control to set the torque. Sensitive trigger to control the speed.

IT Chiave a percussione con regolazione della potenza per la selezione della coppia di serraggio. Grilletto sensibile per una precisa regolazione dei giri.

PT Chave de impacto polegada, com regulação de potência para fixação individual do binário de aperto. Gatilho sensível para controle exacto de velocidade.

Ref	rpm								
<b>0900 0101</b>	3.500 rpm	9,92 kg	6,5 bar	1"	1/2"	665 l/min	2170 (N)	1	<b>1.055,98</b>

**1"**



**CORTA / COUPE / SHORT / COMPATTA / CURTO**

Ref	rpm								
<b>0900 0102</b>	4.000 rpm	10,36 kg	6,5 bar	1"	1/2"	708 l/min	2425 (N)	1	<b>983,16</b>

**1"**



**LARGA / LONG / LONG / LUNGA / LONGO**

Ref	rpm								
<b>0900 0103</b>	4.000 rpm	11,70 kg	6,5 bar	1"	1/2"	708 l/min	2425 (N)	1	<b>1.159,19</b>





PISTOLA PLÁSTICO RÍGIDO DE SOPLAR / PISTOLET À AIR / AIR BLOW GUN / PISTOLA AD ARIA IN PLASTICA RIGIDA / PISTOLA DE AR DE PLÁSTICO RÍGIDO

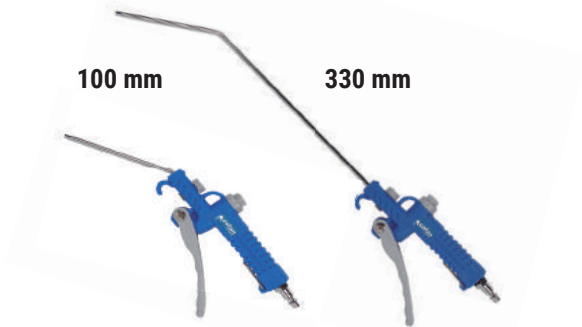

Ref	↔	🔫	📦	📊	📄
0900 0911	100 mm	1/4"	1	10,20	✓
0900 0910	330 mm	1/4"	1	11,95	✓

PISTOLA DE SOPLAR (ALUMINIO) / PISTOLET À AIR (ALUMINIUM) / AIR DUSTER (ALUMINIUM)  
PISTOLA AD ARIA (ALLUMINIO) / PISTOLA DE AR (ALUMÍNIO)



Ref	📊	🔫	📦	📊	📄
0900 0950	140 g	1/4"	1	10,35	✓

MINI SOPLADORA ALTO RENDIMIENTO / JEU PISTOLET D'AIR (HAUTE PERFORMANCE) / SAFETY AIR BLOW GUN (HIGH PERFORMANCE)  
PISTOLA AD ARIA COMPRESSA DI SICUREZZA (ELEVATE PRESTAZIONI) / MINI SOPRADOR ALTO RENDIMENTO

**ALUMINIO**



Max. DBA: 85



Presión max / Pression max / Max. Pressure  
Pressione massima / Pressão máxima:  
10 BAR - 150 PSI

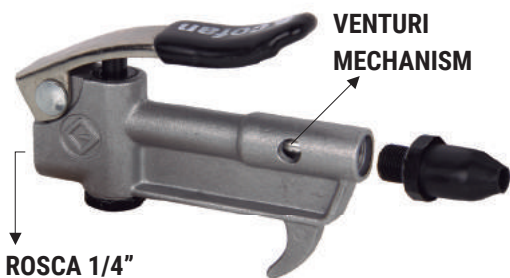

ES A diferencia de cualquier otra pistola de aire con palanca de campo metálico, estas características revolucionarias del mecanismo VENTURI, utilizan orificios laterales para combinar aire libre con aire comprimido, creando un mayor volumen de salida de aire en buenas condiciones.

FR Contrairement à tous les autres pistolets à levier au corps métallique, ils sont dotés du mécanisme révolutionnaire « Venturi » intégré utilise des ports latéraux pour combiner l'air ambiant avec le coùteux air comprimé. Cette caractéristique est exclusive des pistolets à air, en produisant un volume de débit beaucoup plus grand.

EN The Groz PRO Series Lever Air Blow Guns is not just an On/Off valve. Unlike any other metal body lever air gun, these feature revolutionary "Venturi" mechanism that uses side ports to combine free ambient air with costly compressed air, creating a much higher volume of usable output.

IT A differenza di qualsiasi altra pistola ad aria compressa con leva e corpo in metallo, questi dispongono del rivoluzionario meccanismo "Venturi" che utilizza le porte laterali per combinare l'aria ambiente libera con aria compressa costosa, producendo un volume di flusso molto maggiore.

PT Ao contrário de qualquer outra pistola de ar com alavanca e corpo de metal, estas apresentam o revolucioário mecanismo "Venturi" que utiliza portas laterais para combinar ar ambiente com o custoso ar comprimido, produzindo um volume de caudal muito maior.

Ref	📊	🔫	📦	📊	📄
0900 0948	139 g	1/4"	1	14,04	✓

MINI SOPLADORA ALTO RENDIMIENTO + 5 ACCESORIOS  
PISTOLET DE SOUFLETTE (HAUTE PERFORMANCE) + 5 ACCESSOIRES  
SAFETY AIR BLOW GUN (HIGH PERFORMANCE) + 5 ACCESSORIES  
PISTOLA ARIA COMPRESSA (ELEVATE PRESTAZIONI) + 5 ACCESSORI  
PISTOLA DE AR COMPRIMIDO ALTO RENDIMENTO + 5 ACCESORIOS

**INCLUDE / INCLUT: / INCLUDES: / INCLUDI: / INCLUE:**

- |                                    |                               |
|------------------------------------|-------------------------------|
| Aguja de soplado corta: 42 mm      | Prolongador: 70 mm            |
| Embout bec rallonge courte : 42 mm | Tige d'extension : 70 mm      |
| Short needle tip: 42 mm            | Extended nozzle: 70 mm        |
| Lunghezza asta piccola : 42 mm     | Esteso ugello : 70 mm         |
| Bico curto: 42 mm                  | Bico com prolongamento: 70 mm |
| Aguja de soplado larga: 60 mm      | Adaptador de soplado (2 pcs.) |
| Embout bec rallonge longue : 60 mm | Buses (2 pcs.)                |
| Large needle tip: 60 mm            | Rubber Tip (2 pcs.)           |
| Lunghezza asta grande : 60 mm      | Gonfiaggio (2 pz.)            |
| Bico longo: 60 mm                  | Ponta Borracha (2 pç.)        |

Ref	📊	🔫	📦	📊	📄	
0900 0949	139 g	1/4"	1	10	29,90	✓

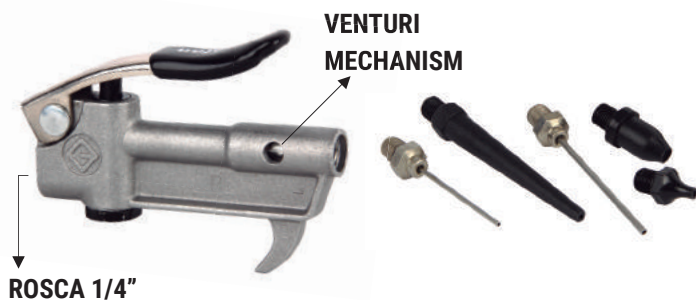



MANÓMETRO E INFLADOR 0-8 BAR / GONFLEUR-MANOMÈTRE DE PNEUMATIQUES 0-8 BARS / TIRE INFLATOR GAUGE 0-8 BAR  
 MANOMETRO E POMPA 0-8 BAR / MANÓMETRO E INSUFLADOR 0-8 BAR

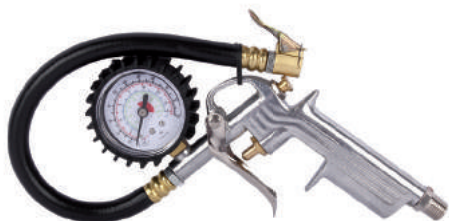

Ref					
0900 090901	1/4"	0-8 bar	1	30,80	✓

INFLADOR NEUMÁTICO PROFESIONAL / GONFLEUR PNEUMATIQUE PROFESSIONEL / PROFESSIONAL TYRE INFLATOR GAUGE  
 GONFIAGOMME PROFESSIONALE / CALIBRADOR PNEUMÁTICO PROFISSIONAL



**1 50PSI - 3,5 BAR**

Ref			
0900 0928	0-10 bar	1	63,00

**2 230PSI - 16 BAR**

Ref			
0900 0929	0-16 bar	1	87,75

PISTOLAS DE PINTAR / PISTOLET A AIR / AIR DUSTER  
 PISTOLE PER VERNICI / PISTOLA DE PINTAR

PISTOLA DE PINTAR HVLP + REGULADOR / PISTOLET A PEINTURE-REGULATEUR / H.V.L.P. GRAVITY AIR SPRAY GUN  
 PISTOLA A SPRUZZO CON REGOLATORE / PISTOLA DE PINTAR HVLP + REGULADOR

HVLP



ES Pistola de pintar con regulador aire-pintura en gatillo. Incluye regulador de presión a la entrada de la pistola. Alta transferencia de producto incluso con poca salida de aire. Completamente en acero inoxidable. Es compatible con pinturas al agua.

FR Pistolet avec régulateur air-peinture sur la gachette. Débit élevé de produit même avec peu de pression d'air. Totalemment en inox. Compatible avec peintures à eau. Evantail de projection réglable en amplitude et quantité de produit.

EN Spray gun with air-paint regulating trigger. Pressure regulator in the hose entrance part. High product transfer even with a low air pressure. Stainless steel body. Compatible with water based paints.

IT Pistola a spruzzo con regolatore aria-vernici nel grilletto. Con regolatore di pressione all'entrata della stessa. Elevato trasferimento di prodotto miscelato ad una limitata quantità d'aria. Realizzata completamente in acciaio inossidabile. Compatibile con le pitture ad acqua.

PT Pistola de pintar gravitacional com regulador ar-pintura no gatilho. Contém regulador de pressão á entrada da pistola. Transferência elevada de produto mesmo com pouca saída de ar. Em aço inoxidável. Compatível com pinturas de água.

Ref							
0900 0901	2 - 5 kg	1/4"	Gravity	600 c.c.	1,4 mm	1	199,00

PISTOLA DE PINTAR / PISTOLET A PEINTURE / AIR SPRAY GUN / PISTOLA A SPRUZZO / PISTOLA DE PINTAR



ES Pistola de pintar con regulador aire-pintura en el gatillo. Alta transferencia de producto incluso con poca salida de aire. Completamente en acero inoxidable.

FR Pistolet avec régulateur air-peinture sur la gachette. Débit élevé de produit même avec peu de pression d'air. Totalemment en inox. Compatible avec peintures à eau.

EN Spray gun with air-paint regulating trigger. High product transfer even with a low air pressure. Stainless steel body.

IT Pistola a spruzzo con regolatore aria-vernici nel grilletto. Elevato trasferimento di prodotto miscelato ad una limitata quantità d'aria. Realizzata completamente in acciaio inossidabile.

PT Pistola de pintar gravitacional com regulador ar-pintura no gatilho. Transferência elevada do produto mesmo com pouca saída de ar. Completamente em aço inoxidável.

Ref							
0900 0902	3,5 - 4,8 kg	1/4"	Gravity	600 c.c.	1,4 mm	1	136,19



SIERRA NEUMÁTICA / SCIE PNEUMATIQUE / AIR BODY SAW / SEGA PNEUMÁTICA / SERRA PNEUMÁTICA



ES Sierra neumática para trabajos de corte en todos los materiales. Muy fácil de usar por su poco peso y gran facilidad de corte. Regulador de velocidad según el tipo de material. Palanca de accionamiento de total seguridad.

FR Travaux de coupe sur tous matériaux. Très maniable et légère, elle facilite les coupes. Régulateur de vitesse selon les matériaux. Levier d'actionnement sécurisé.

EN Ready to use on all materials. Easy to use, light weight and cutting easiness. Speed controller depending on the material. Security drive lever.

IT Sega pneumatica per lavori di taglio di qualunque materiale. Molto facile da usare grazie al peso ridotto ed alla grande facilità di taglio. Regolazione della velocità secondo il tipo di materiale. Leva di azionamento di totale sicurezza. Disponibili lame per acciaio, alluminio e legno.

PT Serra pneumático para trabalhos de cortar em todos os materiais. Muito fácil de usar por causa de seu peso leve e facilidade de corte. Regulador de velocidade, dependendo do tipo de material. Alavanca de acionamento com segurança total.

Ref							
0900 0801	6,5 bar	1/4"	142 l/min	10.000	Steel: 1,6mm - Aluminium: 2,5 mm	1	170,87

HOJA DE SIERRA / LAME DE SCIE / SAW BLADE / LAMA PER / LÂMINA DE SERRA



Ref				
0976 0103	ACERO / ACIER / STEEL / ACCIAIO / AÇO	32	1	3,07
0976 0104	ALUMINIO / ALUMINIUM / ALUMINIUM / ALLUMINIO / ALUMÍNIO	24	1	3,07
0976 0105	MADERA / BOIS / WOOD / LEGNO / MADEIRA	18	1	3,07

ATORNILLADORES NEUMÁTICOS / VISSEUSE PNEUMATIQUE / PEIC SCREWDRIVERS  
AVVITATORI LINEARI PNEUMATICI / CHAVES DE FENDAS PNEUMÁTICAS

ATORNILLADOR CON EMBRAGUE AJUSTABLE EN EL EXTERIOR / VISSEUSE REVERSIBLE A REGULATION EXTERNE  
EXTERNAL ADJUSTABLE CLUTCH AIR SCREWDRIVER / AVVITATORE CON FRIZIONE REGOLABILE ESTERNA  
CHAVE DE FENDA COM EMBREAGEM AJUSTÁVEL NO EXTERIOR



800 RPM

Ref	rpm							
0900 0906	800 rpm	6,5 bar	1/4"	269 l/min	1,50 kg	8 x 12	1	377,52

ATORNILLADOR RECTO CON EMBRAGUE AJUSTABLE EN EL EXTERIOR / VISSEUSE REVERSIBLE A REGULATION EXTERNE  
EXTERNAL ADJUSTABLE CLUTCH AIR SCREWDRIVER / AVVITATORE LINEARE CON FRIZIONE REGOLABILE ESTERNA  
CHAVE DE FENDA RETA COM EMBREAGEM AJUSTÁVEL NO EXTERIOR

800 RPM  
1800 RPM



Ref	rpm						
0900 0907	1800 rpm	6,5 bar	1/4"	232 l/min	8 x 12	1	402,90
0900 0908	800 rpm	6,5 bar	1/4"	232 l/min	8 x 12	1	455,42



GRAPADORA NEUMÁTICA M80 / CLOUEUSE PNEUMATIQUE M80 / PNEUMATIC STAPLER M80  
FISSATRICE PNEUMATICA M80 / AGRAFADOR PNEUMÁTICO M80



ES Grapadora neumática para grapas modelo 80 y longitud entre 6 y 16 mm. Muy práctica y útil en aplicaciones para bricolaje y profesional. 1 kg.

FR Agrafeuse pneumatique pour des agrafes modèle 80 et longueur entre 6 et 16 mm Très pratique et utile pour des opérations de bricolage et usage professionnel. 1 kg.

EN Pneumatic stapler for 80 series staples and length between 6 and 16 mm. Very convenient and useful for professional and DIY works. 1kg.

IT Pinzatrice pneumatica per punte metalliche modello 80 e lunghezza tra 6 e 16 mm. Pratica e utile sia per utilizzi professionali che fai da te. 1 Kg.

PT Agrafadora pneumática para agrafos modelo 80 e comprimento entre 6 e 16 mm. Muito prática e útil em aplicações de bricolagem e profissional. 1 kg.

Ref			
0900 2011	10	1	81,29

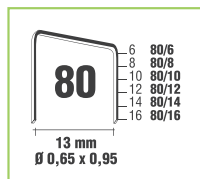

Relación de grapas con referencias / List of staples with references / Elenco punte metalliche con codici  
Lista de agrafos com referências / Lista de agrafos com referências

Ref	MODEL				
0900 2090	6 mm 80/6	10000 pcs	1	20	9,22
0900 2091	8 mm 80/8	10000 pcs	1	20	10,55
0900 2092	10 mm 80/10	10000 pcs	1	20	11,42
0900 2093	12 mm 80/12	10000 pcs	1	20	12,74
0900 2094	14 mm 80/14	10000 pcs	1	20	14,06
0900 2095	16 mm 80/16	10000 pcs	1	20	15,29



GRAPADORA/CLAVADORA NEUMÁTICA TG50-M90 / AGRAFEUSE/CLOUEUSE PNEUMATIQUE TG50-M90 / PNEUMATIC STAPLER/NAILER TG50-M90  
FISSATRICE PNEUMATICA, CHIODI TG50-M90 / GRAMPEADOR/AGRAFADOR PNEUMÁTICO TG50-M90



ES Clavadora-grapadora neumática para clavos (TG) Ø1x1,25 mm con longitud entre 15 y 50 mm, y grapas modelo 90 con longitud entre 20 y 38 mm. Muy práctica y útil en aplicaciones para bricolaje y profesional. 1,5 kg.

FR Agrafeuse-pistolet à clou pneumatique pour clous (TG) Ø1x1,25 mm, et longueur entre 15 et 50 mm, et agrafes modèle 90 et longueur entre 20 et 38 mm Très pratique et utile pour des opérations de bricolage et usage professionnel. 1.5 kg.

EN Pneumatic stapler-nailer for (TG) nails Ø1x1.25 mm, length between 15 and 50 mm; 90 series staples and length between 20 and 38 mm. Very convenient and useful for professional and DIY works. 1.5 kg.

IT Pinzatrice/Chiodatrice pneumatica per chiodi (TG) Ø1x1,25mm e lunghezza tra 15 e 50 mm; punte metalliche modello 90 e lunghezza tra 20 e 38 mm. Pratica e utile sia per utilizzi professionali che fai da te. 1,5 Kg.

PT Pregadora-Agrafadora pneumática para pregos (TG) Ø1x1,25 mm e comprimento entre 15 e 50 mm e agrafos modelo 90 e comprimento entre 20 e 38 mm. Muito prática e útil em aplicações de bricolagem e profissional. 1,5 kg.

Ref			
0900 2010	5	1	111,38

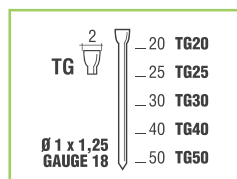

Relación de clavos con referencias / Relation avec les clous en référence / List of nailers with references  
Elenco chiodi con codici / Lista de pregos com referências

Ref	MODEL				
0900 2071	20 mm TG20	5000 pcs	1	20	17,91
0900 2072	25 mm TG25	5000 pcs	1	20	20,31
0900 2073	30 mm TG30	5000 pcs	1	10	22,00
0900 2074	40 mm TG40	5000 pcs	1	10	27,52
0900 2075	50 mm TG50	5000 pcs	1	10	29,95

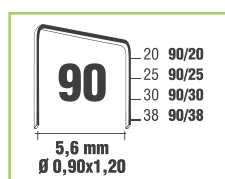

Relación de grapas con referencias / List of staples with references / Elenco punte metalliche con codici  
Lista de agrafos com referências / Lista de agrafos com referências

Ref	MODEL				
0900 2080	20 mm 90/20	5000 pcs	1	12	17,69
0900 2081	25 mm 90/25	4000 pcs	1	12	17,05
0900 2082	30 mm 90/30	4000 pcs	1	10	20,03
0900 2083	38 mm 90/38	3000 pcs	1	10	18,58







CLAVADORA NEUMÁTICA TG30 / PISTOLET A CLOU PNEUMATIQUE TG30 / PNEUMATIC NAILER TG30  
CHIODATRICE PNEUMATICA TG30 / PREGADORA PNEUMÁTICA TG30



ES Clavadora neumática para clavos (TG) Ø1x1,25 mm, con longitud entre 15 y 30 mm. Muy práctica y útil en aplicaciones para bricolaje y profesional. 1,1 kg.

FR Pistolet à clou pneumatique pour clous (TG) Ø1x1,25mm, longueur entre 15 et 30 mm Très pratique et utile pour des opération de bricolage et usage professionnel. 1.1 kg.

EN Pneumatic nailer for (TG) nails Ø1x1,25 mm and length between 15 and 30 mm. Very convenient and useful for professional and DIY works. 1.1kg.

IT Chiodatrice pneumatica per chiodi (TG) Ø1x1,25mm e lunghezza tra 15 e 30 mm. Pratica e utile sia per utilizzi professionali che fai da te. 1,1 Kg.

PT Pregadora pneumática para pregos (TG) Ø1x1,25 mm e comprimento entre 15 e 30 mm. Muito prática e útil em aplicações de bricolagem e profissional. 1,1 kg.

Ref			
0900 2008	10	1	94,46

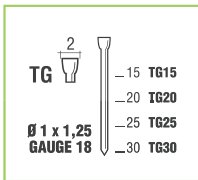

Relación de clavos con referencias / Relation avec les clous en référence / List of nailers with references  
Elenco chiodi con codici / Lista de pregos com referências



Ref	MODEL				
0900 2070	15 mm TG15	5000 pcs	1	20	15,60
0900 2071	20 mm TG20	5000 pcs	1	20	17,91
0900 2072	25 mm TG25	5000 pcs	1	10	20,31
0900 2073	30 mm TG30	5000 pcs	1	10	22,00

CLAVADORA NEUMÁTICA TG50 / PISTOLET A CLOU PNEUMATIQUE TG50 / PNEUMATIC NAILER TG50  
CHIODATRICE PNEUMATICA TG50 / PREGADORA PNEUMÁTICA TG50



ES Clavadora neumática para clavos (TG) Ø1x1,25 mm, con longitud entre 15 y 50 mm. Muy práctica y útil en aplicaciones para bricolaje y profesional. 1,5 kg.

FR Pistolet à clou pneumatique pour clous (TG) Ø1x1,25mm, longueur entre 15 et 50 mm Très pratique et utile pour des opération de bricolage et usage professionnel. 1.5 kg.

EN PNEUMATIC NAILER for nails (TG) Ø1x1,25 mm and length between 15 and 50 mm. Very convenient and useful for professional and DIY works. 1.5kg.

IT Chiodatrice pneumatica per chiodi (TG) Ø1x1,25mm e lunghezza tra 15 e 50 mm. Pratica e utile sia per utilizzi professionali che fai da te. 1,5 Kg.

PT Pregadora pneumática para pregos (TG) Ø1x1,25 mm e comprimento entre 15 e 50 mm. Muito prática e útil em aplicações de bricolagem e profissional. 1,5 kg.

Ref			
0900 2009	1	10	102,65

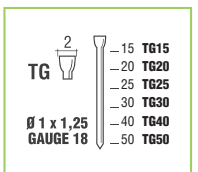

Relación de clavos con referencias / Relation avec les clous en référence / List of nailers with references  
Elenco chiodi con codici / Lista de pregos com referências



Ref	MODEL				
0900 2070	15 mm TG15	5000 pcs	1	20	15,60
0900 2071	20 mm TG20	5000 pcs	1	20	17,91
0900 2072	25 mm TG25	5000 pcs	1	20	20,31
0900 2073	30 mm TG30	5000 pcs	1	10	22,00
0900 2074	40 mm TG40	5000 pcs	1	10	27,52
0900 2075	50 mm TG50	5000 pcs	1	10	29,95



KIT HERRAMIENTA NEUMÁTICA 5 PCS / KIT D'ENTRETIEN POUR OUTILLAGE PNEUMATIQUE 5 PCS / 5 PCS AIR TOOL KIT  
 KIT 5 PEZZI PISTOLE AD ARIA / KIT FERRAMENTAS PNEUMÁTICAS 5 PCS



Ref				
0900 0909	1/4"	1	98,33	✓

PISTOLA DE PETROLEAR / PISTOLET POUR NETTOYAGE DE MOTEUR / AIR ENGINE CLEANING GUN  
 PISTOLA AD ARIA PER LAVAGGIO MOTORE / ALMOTOLIA



Ref				
0900 0912	543 g	1/4"	1	47,13

ACCESORIO LUBRICANTE / ACCESSOIRES GRAISSEUR / OILER ACCESSORY / ACCESSORI LUBRIFICANTE / ACESSÓRIO LUBRIFICANTE



Ref				
0900 0930	150 g	1/4"	1	8,21





MANGUERA ESPIRAL POLIURETANO MÁS ENCHUFES RÁPIDOS / FLEXIBLE À SPIRALE EN POLYURÉTHANE ET RACCORDS RAPIDES  
 POLYURETHANE COIL WITH FITTINGS / TUBO A SPIRALE IN POLIURETANO / MANGUEIRA EM ESPIRAL DE POLIURETANO COM ACOPLADORES RÁPIDOS



**PVC**  
**15 bar**

Ref	Ø	↔	📏	📦	📊
<b>0900 0954</b>	6,5x10 mm	7,5 m	1/4"	1	<b>40,46</b>
<b>0900 0956</b>	6,5x10 mm	15 m	1/4"	1	<b>61,52</b>
<b>0900 0955</b>	8x12 mm	7,5 m	1/4"	1	<b>54,15</b>
<b>0900 0957</b>	8x12 mm	15 m	1/4"	1	<b>76,08</b>

MANGUERA COMPRESOR / FLEXIBLE COMPRESSEUR / COMPRESSOR AIR HOSE  
 TUBO COMPRESSORE / MANGUEIRA COMPRESSOR



**PVC**  
**15 bar**

Ref	Ø	↔	📏	📦	📊
<b>0900 0916</b>	8x12 mm	7,5 m	1/4"	1	<b>32,29</b>
<b>0900 0917</b>	8x12 mm	15 m	1/4"	1	<b>46,55</b>
<b>0900 0918</b>	10x15 mm	15 m	1/4"	1	<b>49,10</b>
<b>0900 0919</b>	13x19 mm	15 m	1/2"	1	<b>79,15</b>



**PVC**  
**15 bar**

ES REFORZADA  
 FR RENFORCÉE  
 EN REINFORCED  
 IT RINFORZATA  
 PT REFORÇADA

Ref	Ø	↔	📏	📦	📊
<b>0900 0961</b>	8,5x12,5 mm	50 m		1	<b>49,50</b>
<b>0900 0962</b>	10x15 mm	50 m		1	<b>58,70</b>
<b>0900 0963</b>	13x17 mm	50 m		1	<b>82,20</b>

ENROLLADOR C/MANGUERA AIRE / ENROULEUR TUYAU ET TUYAU AIR / AIR HOSE AND HOSE REE  
 AVVOLGITUBO CON TUBO DELL'ARIA / ENROLADOR COM MANGUEIRA AR



**PVC - Manguera**  
**24 bar**  
**-5°C + 45°C**

ES Enrollador con recogedor automático, soporte PP. Anclaje - soporte pared.  
 FR Enrouleur avec collecteur automatique, support PP. Anclage - support mural.  
 EN Hose reel with an automatic retraction mechanism and a PP wall mounting bracket. Wall mounting bracket - anchoring.  
 IT Avvolgitubo con sistema di riavvolgimento automatico e staffa di fissaggio in PP. Staffa di fissaggio per montaggio a parete - ancoraggi.  
 PT Enrolador com recolha automática, suporte PP. Fixar-suporte de parede.

Ref	Ø	↔	📏	📦	📊
<b>0900 0965</b>	9,5x15 mm	15 m	1/4"	1	<b>85,15</b>



ES El armazón externo es de aluminio no explosivo, duradero y usándolo normalmente no se romperá. Los armazones tienen unos 10 años de durabilidad. La función de secado elimina por completo la humedad y el vapor.

FR Armature externe en aluminium, non explosif, durable et incassable pour un usage normal. Armature d'une durée de vie de 10 ans. La fonction dessiccant élimine totalement l'humidité et la vapeur.

EN Non-explosive aluminum external shell is durable, and under normal use, will not break. Shells have 10 years life span. The moisture-free and drying function, remove completely moisture and vapor.

IT Struttura esterna in alluminio, non esplosiva, durevole ed infrangibile nell'uso normale. L'armatura esterna ha una durata di circa dieci anni. La funzione essiccante elimina completamente condensa e vapore.

PT O revestimento exterior é de alumínio não explosivo, é durável, e sob condições normais de uso, não vai quebrar. Este revestimento tem 10 anos de vida. A função de secagem elimina completamente a humidade e vapor.

FILTRO CON REGOLADOR Y DEPÓSITO DE LUBRICANTE 1/2" / FILTRE AVEC REGULATEUR ET RESERVOIR DE LUBRIFIANT 1/2"  
1/2" AIR FILTER REGULATOR AND LUBRICATOR / FILTRO CON REGOLATORE E DEPOSITO DI LUBRIFICANTE 1/2"  
FILTRO COM REGULADOR E DEPÓSITO DE LUBRIFICANTE 1/2"



Ref	Icon	max	Icon	Icon	Icon
0900 0920	3/8"	1.0 -15.0 kg	2.700 L	1	218,92

FILTRO CON REGULADOR / FILTRE AVEC REGULATEUR / REGULATOR FILTER / FILTRO CON REGOLATORE / FILTRO COM REGULADOR



Ref	Icon	max	Icon	Icon	Icon
0900 0921	1"	9,9 kg	5.000 L	1	304,20
0900 0922	3/4"	9,9 kg	4.500 L	1	132,50
0900 0923	1/2"	9,9 kg	4.000 L	1	119,32
0900 0924	3/8"	9,9 kg	2.000 L	1	144,92

FILTRO CON REGULADOR Y DEPÓSITO DE LUBRICANTE 1/2" / 1/2" AIR FILTER REGULATOR AND LUBRICATOR



Ref	Icon	max	Icon	Icon	Icon
0900 0925	1/2"	0.5 -8.5 kg	4.000 L	1	239,30

Ref	Icon	max	Icon	Icon	Icon
0900 0926	1"	0.5 -8.5 kg	5.000 L	1	457,86



ENCHUFE RÁPIDO ROSCA MACHO / RACCORD RAPIDE FILET MALE / MALE THREAD AIR QUICK COUPLER  
PRESA RAPIDA FILETTO MASCHIO / ACOPLADOR RÁPIDO COM ROSCA MACHO



Ref	🌀	📦	📊	📄
0900 0068	1/4"	1	7,38	✓
0900 0070	3/8"	1	8,29	✓
0900 0072	1/2"	1	8,99	✓

ENCHUFE RÁPIDO ROSCA HEMBRA / RACCORD RAPIDE FILET FEMELLE / FEMALE THREAD AIR QUICK COUPLER  
PRESA RAPIDA FILETTO FEMMINA / ACOPLADOR RÁPIDO COM ROSCA FÊMEA



Ref	🌀	📦	📊	📄
0900 0082	1/4"	1	7,76	✓
0900 0084	3/8"	1	8,72	✓
0900 0086	1/2"	1	9,36	✓

ENCHUFE RÁPIDO CON ESPIGA / RACCORD RAPIDE SAPIN / TUBE AIR QUICK COUPLER / PRESA RAPIDA A SPIGA / ACOPLADOR RÁPIDO COM ESPIGA



Ref	🌀	📦	📊	📄
0900 0074	6 mm	1	8,08	✓
0900 0076	8 mm	1	7,38	✓
0900 0078	10 mm	1	7,38	✓
0900 0080	13 mm	1	7,54	✓

CONECTOR ROSCA MACHO / CONNECTEUR FILET MALE / MALE THREAD AIR CONNECTOR  
CONNETTORE FILETTO MASCHIO / CONECTOR ROSCA MACHO



Ref	🌀	📦	📊	📄
0900 0058	1/4"	1	1,87	✓
0900 0059	3/8"	1	2,35	✓
0900 0060	1/2"	1	3,32	✓

CONECTOR ROSCA HEMBRA / CONNECTEUR FILET FEMELLE / FEMALE THREAD AIR CONNECTOR  
CONNETTORE FILETTO FEMMINA / CONECTOR ROSCA FÊMEA



Ref	🌀	📦	📊	📄
0900 0061	1/4"	1	2,41	✓
0900 0062	3/8"	1	2,57	✓
0900 0063	1/2"	1	2,68	✓

CONECTOR CON ESPIGA / CONNECTEUR SAPIN / TUBE AIR CONNECTOR / CONNETTORE A SPIGA / CONECTOR COM ESPIGA



Ref	🌀	📦	📊	📄
0900 0064	6 mm	1	1,93	✓
0900 0065	8 mm	1	2,03	✓
0900 0066	10 mm	1	2,25	✓
0900 0067	13 mm	1	2,46	✓



## ENCHUFES RÁPIDOS / RACCORDS RAPIDES / AIR QUICK COUPLER PRESE RAPIDE / ACOPLADORES RÁPIDOS

cofan

### ENCHUFES RÁPIDOS VARIAS SALIDAS / RACCORDS RAPIDES PLUSIEURS SORTIES / MORE WAY AIR QUICK COUPLERS PRESE RAPIDE A PIU' VIE / ACOPLADORES RÁPIDOS VÁRIAS SAÍDAS



3 salidas / 3 sorties / 3-way quick / 3 vie / 3 saídas

Ref				
0900 0088	1/4"	1	27,71	✓



2 salidas / 2 sorties / 2-way quick / 2 vie / 2 saídas

Ref				
0900 0089	1/4"	1	17,98	✓

3 salidas - Tipo flor / 3 sorties - Type fleur / 3-way - Flower shape  
3 vie - Tipo fiore / 3 saídas - Flor

Ref				
0900 0090	1/4"	1	30,07	✓

### ENCHUFES RÁPIDOS UNIVERSALES / RACCORD RAPIDE UNIVERSEL / UNIVERSAL AIR QUICK COUPLERS RACCORDI UNIVERSALI / ACOPLADORES RÁPIDOS UNIVERSAIS



ES Enchufe rápido con diseño especial, válido para diferentes modelos.

FR Raccord rapide avec dessin special, valide pour differents modeles.

EN Special design couplers, can be applied different connectors.

IT Raccordi rapidi a disegno speciale, validi per diversi modelli.

PT Acoplador rápido com desenho especial, válido para modelos diferentes.

Enchufe rápido rosca macho / Raccord rapide filet male / Male thread air quick coupler  
Pres a rapida filetto maschio / Conector Rosca Macho

Ref				
0900 0069	1/4"	1	9,79	✓
0900 0071	3/8"	1	9,84	✓
0900 0073	1/2"	1	9,52	✓



Enchufe rápido con espiga / Raccord rapide sapin / Tube air quick coupler  
Pres a rapida a spiga / Acoplador rápido com espiga

Ref				
0900 0075	6 mm	1	9,31	✓
0900 0077	8 mm	1	9,31	✓
0900 0079	10 mm	1	9,31	✓
0900 0081	13 mm	1	10,43	✓



Enchufe rápido rosca hembra / Raccord rapide filet femelle / Female thread air quick coupler  
Pres a rapida filetto femmina / Conector Rosca Fêmea

Ref				
0900 0083	1/4"	1	9,52	✓
0900 0085	3/8"	1	9,52	✓
0900 0087	1/2"	1	10,91	✓





ENCHUFE RÁPIDO ROSCA MACHO / RACCORD RAPIDE FILET MALE / MALE THREAD AIR QUICK COUPLER  
PRESA RAPIDA FILETTO MASCHIO / ACOPLADOR RÁPIDO COM ROSCA MACHO

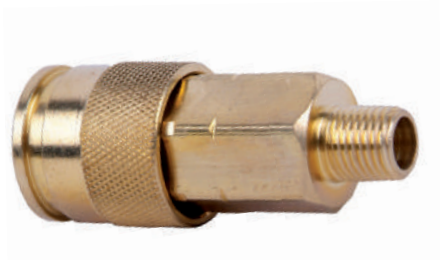

GRAN CAUDAL / HIGH VOLUME

Ref	🌀	📦	📊	📄
0900 0068G	1/4"	1	12,63	✓
0900 0070G	3/8"	1	12,79	✓
0900 0072G	1/2"	1	12,85	✓

ENCHUFE RÁPIDO ROSCA HEMBRA / RACCORD RAPIDE FILET FEMELLE / FEMALE THREAD AIR QUICK COUPLER  
PRESA RAPIDA FILETTO FEMMINA / ACOPLADOR RÁPIDO COM ROSCA FÊMEA

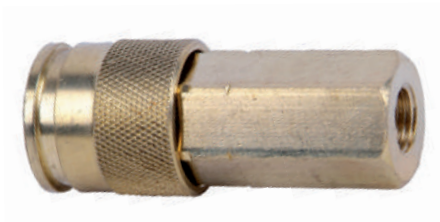

GRAN CAUDAL / HIGH VOLUME

Ref	🌀	📦	📊	📄
0900 0082G	1/4"	1	12,95	✓
0900 0084G	3/8"	1	13,54	✓
0900 0086G	1/2"	1	15,09	✓

ENCHUFE RÁPIDO CON ESPIGA / RACCORD RAPIDE SAPIN / TUBE AIR QUICK COUPLER  
PRESA RAPIDA A SPIGA / ACOPLADOR RÁPIDO COM ESPIGA

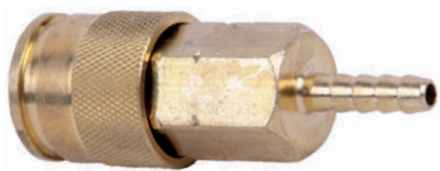

GRAN CAUDAL / HIGH VOLUME

Ref	🌀	📦	📊	📄
0900 0074G	6 mm	1	10,97	✓
0900 0076G	8 mm	1	12,89	✓
0900 0078G	10 mm	1	12,85	✓
0900 0080G	13 mm	1	11,68	✓

CONECTOR ROSCA MACHO / CONNECTEUR FILET MALE / MALE THREAD AIR CONNECTOR  
CONNETTORE FILETTO MASCHIO / CONECTOR ROSCA MACHO

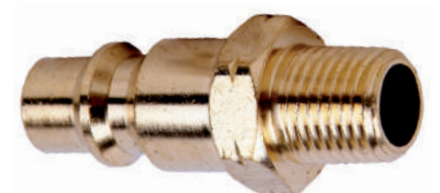

GRAN CAUDAL / HIGH VOLUME

Ref	🌀	📦	📊	📄
0900 0058G	1/4"	1	2,46	✓
0900 0059G	3/8"	1	2,73	✓
0900 0060G	1/2"	1	3,64	✓

CONECTOR ROSCA HEMBRA / CONNECTEUR FILET FEMELLE / FEMALE THREAD AIR CONNECTOR  
CONNETTORE FILETTO FEMMINA / CONECTOR ROSCA FÊMEA



GRAN CAUDAL / HIGH VOLUME

Ref	🌀	📦	📊	📄
0900 0061G	1/4"	1	2,67	✓
0900 0062G	3/8"	1	2,46	✓
0900 0063G	1/2"	1	3,32	✓



CONECTOR CON ESPIGA / CONNECTEUR SAPIN / TUBE AIR CONNECTOR / CONNETTORE A SPIGA / CONECTOR COM ESPIGA

**GRAN CAUDAL / HIGH VOLUME**



Ref	📏	📦	📊	📌
<b>0900 0064G</b>	6 mm	1	<b>3,10</b>	✓
<b>0900 0065G</b>	8 mm	1	<b>3,10</b>	✓
<b>0900 0066G</b>	10 mm	1	<b>3,10</b>	✓
<b>0900 0067G</b>	13 mm	1	<b>3,21</b>	✓

MALETÍN ENCHUFES RÁPIDOS / VAISSETTE RACCORDS RAPIDES / QUICK COUPLERS CASE  
VALIGETTA RACCORDI RAPIDI / MALETA DE ACOPLADORES RÁPIDOS



Ref	⬇	📦	📊
<b>0900 9997</b>	Maletín 60 uds, enchufes gran caudal / Malette 60 unités, raccords grands débits 60 pcs case, high volume couplers / Valigetta raccordi, 60 pezzi, grande portata d'aria Maleta de 60 peças, conexões de grande fluxo	1	<b>430,05</b>
<b>0900 9998</b>	Maletín 88 uds, enchufes rápidos universal / Malette 88 unités, raccord rapide universel 88 pcs case, universal couplers / Valigetta da 88 pezzi, raccordi universali Maleta de 88 peças, conexões universais	1	<b>467,34</b>
<b>0900 9999</b>	Maletín 88 uds, enchufes rápidos / Malette 88 unités, raccords rapides 88 pcs case, quick couplers / Valigetta da 88 pezzi, raccordi rapidi Maleta de 88 peças, conexões rápidos	1	<b>395,01</b>

**0900 9997**

Ref	⬇
0900 0058G	3
0900 0059G	3
0900 0060G	3
0900 0061G	3
0900 0062G	3
0900 0063G	3
0900 0064G	3
0900 0065G	3
0900 0066G	3
0900 0067G	3
0900 0068G	3
0900 0070G	3
0900 0072G	3
0900 0074G	3
0900 0076G	3
0900 0078G	3
0900 0080G	3
0900 0082G	3
0900 0084G	3
0900 0086G	3

**0900 9998**

Ref	⬇
0900 0058	5
0900 0059	4
0900 0060	4
0900 0061	5
0900 0062	4
0900 0063	4
0900 0064	6
0900 0065	4
0900 0066	4
0900 0067	4
0900 0069	5
0900 0071	4
0900 0073	4
0900 0075	6
0900 0077	4
0900 0079	4
0900 0081	4
0900 0083	5
0900 0085	4
0900 0087	4

**0900 9999**

Ref	⬇
0900 0058	5
0900 0059	4
0900 0060	4
0900 0061	5
0900 0062	4
0900 0063	4
0900 0064	6
0900 0065	4
0900 0066	4
0900 0067	4
0900 0068	5
0900 0070	4
0900 0072	4
0900 0074	6
0900 0076	4
0900 0078	4
0900 0080	4
0900 0082	5
0900 0084	4
0900 0086	4





EMPALME RAPIDO RECTO PLASTICO / RACCORD RAPIDE DROIT PLASTIQUE / STRAIGHT PLASTIC FITTING  
RACCORDO RAPIDO DRITTO PLASTICA / CONEXÕES RETAS



Ref			
0501 0104	4 mm	10	<b>0,93</b>
0501 0106	6 mm	10	<b>0,96</b>
0501 0108	8 mm	10	<b>0,99</b>
0501 0110	10 mm	10	<b>1,14</b>
0501 0112	12 mm	10	<b>1,46</b>
0501 0114	14 mm	10	<b>3,80</b>
0501 0116	16 mm	10	<b>4,06</b>

EMPALMES REDUCCIÓN / RACCORD REDUCTION / REDUCTION / RACCORDO CON RIDUZIONE / JUNÇÕES DE REDUÇÃO



Ref				
0501 0604	6 mm	4 mm	10	<b>1,46</b>
0501 0804	8 mm	4 mm	10	<b>1,92</b>
0501 0806	8 mm	6 mm	10	<b>1,63</b>
0501 1006	10 mm	6 mm	10	<b>2,19</b>
0501 1008	10 mm	8 mm	10	<b>2,14</b>
0501 1208	12 mm	8 mm	10	<b>2,87</b>
0501 1210	12 mm	10 mm	10	<b>2,29</b>
0501 1412	14 mm	12 mm	10	<b>3,80</b>
0501 1614	16 mm	14 mm	10	<b>3,80</b>

EMPALMES ACODADOS / RACCORD COUDE / ELBOW TYPE / RACCORDO AD ANGOLO / JUNÇÕES TIPO COTOVELO



Ref			
0502 0204	4 mm	10	<b>0,93</b>
0502 0206	6 mm	10	<b>0,96</b>
0502 0208	8 mm	10	<b>0,99</b>
0502 0210	10 mm	10	<b>1,14</b>
0502 0212	12 mm	10	<b>1,46</b>
0502 0214	14 mm	5	<b>3,80</b>
0502 0216	16 mm	5	<b>4,06</b>

EMPALMES "T" / RACCORD "T" / "T" TYPE / RACCORDO "T" / JUNÇÕES "T"



Ref			
0503 0304	4 mm	10	<b>1,47</b>
0503 0306	6 mm	10	<b>1,50</b>
0503 0308	8 mm	10	<b>1,54</b>
0503 0310	10 mm	10	<b>1,61</b>
0503 0312	12 mm	10	<b>2,03</b>
0503 0314	14 mm	5	<b>4,37</b>
0503 0316	16 mm	5	<b>4,73</b>

EMPALMES FORMA CRUZ / RACCORD EN CROIX / CROSS TYPE CONNECTION / RACCORDO A CROCE / JUNÇÕES EM CRUZ



Ref			
0504 0204	4 mm	2	<b>1,82</b>
0504 0206	6 mm	2	<b>2,18</b>
0504 0208	8 mm	2	<b>2,33</b>
0504 0210	10 mm	2	<b>2,07</b>
0504 0212	12 mm	2	<b>3,02</b>



EMPALMES FORMA "Y" / RACCORD FORME "Y" / "Y" TYPE CONNECTION / RACCORDO AD "Y" / JUNÇÕES "Y"



Ref			
0504 0104	4 mm	5	1,34
0504 0106	6 mm	5	1,41
0504 0108	8 mm	5	1,92
0504 0110	10 mm	5	2,04
0504 0112	12 mm	5	2,18
0504 0114	14 mm	5	4,21
0504 0116	16 mm	5	4,58

ESPIGA REDUCTORA / RACCORD SAPIN REDUCTION / UNION TYPE REDUCTION / RIDUZIONE / UNIÃO TIPO REDUÇÃO



Ref				
0500 0004	6 mm	4 mm	5	1,21
0500 0005	8 mm	4 mm	1	1,27
0500 0006	8 mm	6 mm	5	1,27
0500 0007	10 mm	6 mm	1	1,45
0500 0008	10 mm	8 mm	5	1,45
0500 0009	12 mm	8 mm	1	1,79
0500 0010	12 mm	10 mm	5	1,84

CODO ADAPTADOR ORIENTABLE CON ESPIGA LISA / ADAPTATEUR COUDÉ ORIENTABLE TIGE LISSE  
ELBOW TYPE TURNING CONNECTION WITH STRAIGHT PIN / ADATTATORE DIREZIONALE A GOMITO, GAMBO LISCIO  
ADAPTADOR TIPO DE COTOVELO ORIENTÁVEL COM PINO LISO



Ref			
0504 0004	4 mm	2	2,62
0504 0006	6 mm	2	2,98
0504 0008	8 mm	2	3,45
0504 0010	10 mm	2	5,71
0504 0012	12 mm	2	6,19

UNIÓN EN "Y" CON ESPIGA LISA / RACCORD EN "Y" TIGE LISSE / "Y" TYPE CONNECTION WITH STRAIGHT PIN  
GIUNTO AD "Y" CON TESTA LISCIA / UNIÃO E "Y" COM PINO LISO



Ref			
0505 0001	4 mm	1	3,93
0505 0002	6 mm	1	4,54
0505 0003	8 mm	1	5,05
0505 0004	10 mm	1	6,00
0505 0005	12 mm	1	7,21

VÁLVULA DE CIERRE - EMPALME RÁPIDO / VALVE DE SERRAGE - RACCORD RAPIDE / LOCK VALVE - QUICK COUPLER  
VALVOLA DI CHIUSURA - GIUNTO RAPIDO / VÁLVULA DE FECHO - JUNÇÃO RÁPIDA



Ref			
0505 0006	6 mm	1	7,83
0505 0008	8 mm	1	8,63
0505 0010	10 mm	1	10,99
0505 0012	12 mm	1	12,08



VÁLVULA DE CIERRE - ROSCA / VALVE DE SERRAGE - FILET / LOCK VALVE - THREAD / VALVOLA DI CHIUSURA - FILETTO / VÁLVULA DE FECHO - ROSCA



Ref	🌀	📦	📊
0506 0001	1/8"	1	11,70
0506 0002	1/4"	1	17,25
0506 0003	3/8"	1	19,30
0506 0004	1/2"	1	16,30

REGULADOR DE CAUDAL EN LÍNEA TUBO-TUBO / REGULATEUR DE FLUX UNIDIRECTIONNEL EN LIGNE TUBE - TUBE  
IN-LINE ONE-WAY FLOW REGULATOR TUBE-TUBE / REGOLATORE DI FLUSSO UNIDIREZIONALE IN LINEA TUBO-TUBO  
REGULADOR DE FLUXO UNIDIRECIONAL EM LINHA TUBO-TUBO



Ref	🌀	📦	📊
0541 0004	T-4	1	7,01
0541 0006	T-6	1	8,05
0541 0008	T-8	1	9,42
0541 0010	T-10	1	10,70
0541 0012	T-12	1	13,54

REGULADOR DE CAUDAL EN LÍNEA HEMBRA-HEMBRA / REGULATEUR DE FLUX UNIDIRECTIONNEL EN LIGNE H-H / IN-LINE ONE-WAY FLOW REGULATOR F-F  
REGOLATORE DI FLUSSO UNIDIREZIONALE IN LINEA F-F / REGULADOR DE FLUXO UNIDIRECIONAL EM LINHA H-H



Ref	🌀	📦	📊
0542 0018	R-1/8"	1	14,37
0542 0014	R-1/4"	1	20,23
0542 0038	R-3/8"	1	34,65
0542 0012	R-1/2"	1	38,60

REGULADOR DE CAUDAL CÓNICO UNIDIRECCIONAL PARA CILINDRO / REGULADOR CÓNICO UNIDIRECCIONAL PARA CILINDRO  
ONE-WAY FLOW REGULATOR FOR CYLINDER / REGOLATORE CONICO UNIDIRECCIONAL PER CILINDRO / REGULADOR CÓNICO UNIDIRECCIONAL PARA CILINDRO



Ref	🌀	🌀	📦	📊
0540 0418	T-4	R-1/8"	1	7,49
0540 0414	T-4	R-1/4"	1	8,30
0540 0618	T-6	R-1/8"	1	8,30
0540 0614	T-6	R-1/4"	1	8,30
0540 0638	T-6	R-3/8"	1	12,17
0540 0612	T-6	R-1/2"	1	17,47
0540 0818	T-8	R-1/8"	1	8,30
0540 0814	T-8	R-1/4"	1	8,30
0540 0838	T-8	R-3/8"	1	12,17
0540 0812	T-8	R-1/2"	1	17,04
0540 1018	T-10	R-1/8"	1	8,30
0540 1014	T-10	R-1/4"	1	8,30
0540 1038	T-10	R-3/8"	1	12,36
0540 1012	T-10	R-1/2"	1	17,53
0540 1214	T-12	R-1/4"	1	12,36
0540 1238	T-12	R-3/8"	1	12,36
0540 1212	T-12	R-1/2"	1	17,53



UNIÓN RECTA PASAMUROS TUBO-TUBO POLÍMERO / RACCORD DROIT PASSE CLOISON TUBE - TUBE POLYMERE  
BULKHEAD UNION TUBE-TUBE STRAIGHT ADAPTER (POLYMER) / RACCORDO DRITTO PASSAPARETE TUBO-TUBO POLIMERO  
UNIÃO RECTA PASSA-MUROS TUBO-TUBO POLÍMERO

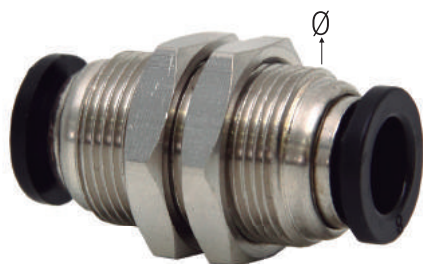

Ref		Ø		
0518 0004	T-4	11 mm	1	3,00
0518 0006	T-6	11 mm	1	3,60
0518 0008	T-8	17 mm	1	4,26
0518 0010	T-10	17 mm	1	6,35
0518 0012	T-12	20 mm	1	8,10

TAPÓN DE CIERRE MACHO POLÍMERO / BOUCHON DE FERMETURE MALE POLYMÈRE / MALE POLYMER BLANKING PLUG  
TAPPO DI CHIUSURA MASCHIO POLIMERO / TAMPÃO DE FECHO MACHO POLÍMERO



Ref			
0519 0004	T-4	1	0,66
0519 0006	T-6	1	0,70
0519 0008	T-8	1	0,71
0519 0010	T-10	1	0,81
0519 0012	T-12	1	0,98

RACORES ROSCADOS / RACCORD FILETÉ / THREAD / FILETTO / CONEXÕES COM ROSCA

Rectos / Droit / Straight / Asse / Retas



Ref					Ref				
0521 0405	4 mm	5 mm	5	0,99	0521 1012	10 mm	1/2"	2	2,70
0521 0414	4 mm	1/4"	10	1,09	0521 1014	10 mm	1/4"	10	1,72
0521 0418	4 mm	1/8"	10	1,13	0521 1018	10 mm	1/8"	10	1,72
0521 0605	5 mm	5 mm	5	1,00	0521 1038	10 mm	3/8"	10	2,07
0521 0612	6 mm	1/2"	5	2,55	0521 1212	12 mm	1/2"	2	2,70
0521 0614	6 mm	1/4"	10	1,20	0521 1214	12 mm	1/4"	10	1,92
0521 0618	6 mm	1/8"	10	1,20	0521 1218	12 mm	1/8"	2	2,03
0521 0638	6 mm	3/8"	10	1,72	0521 1238	12 mm	3/8"	10	2,03
0521 0812	8 mm	1/2"	5	2,70	0521 1412	14 mm	1/2"	2	3,74
0521 0814	8 mm	1/4"	10	1,03	0521 1438	14 mm	3/8"	5	5,75
0521 0818	8 mm	1/8"	10	1,03	0521 1612	16 mm	1/2"	1	4,11
0521 0838	8 mm	3/8"	10	2,07	0521 1638	16 mm	3/8"	1	4,11

Rectos rosca hembra / Droit filetage femelle / Straight with inner thread / Asse, femmina / Retas com rosca fêmea

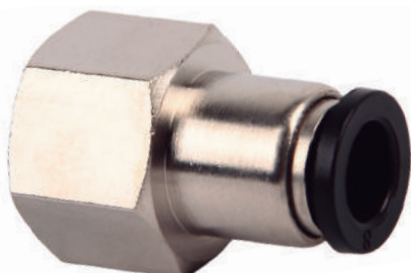

Ref					Ref				
0524 0405	4 mm	5 mm	1	1,74	0524 1012	10 mm	1/2"	1	3,54
0524 0414	4 mm	1/4"	1	2,03	0524 1014	10 mm	1/4"	1	2,18
0524 0418	4 mm	1/8"	1	1,74	0524 1018	10 mm	1/8"	1	2,18
0524 0605	6 mm	5 mm	1	1,74	0524 1038	10 mm	3/8"	1	2,65
0524 0612	6 mm	1/2"	1	2,72	0524 1212	12 mm	1/2"	1	3,54
0524 0614	6 mm	1/4"	5	2,03	0524 1214	12 mm	1/4"	1	3,22
0524 0618	6 mm	1/8"	5	1,74	0524 1218	12 mm	1/8"	1	2,11
0524 0638	6 mm	3/8"	1	2,50	0524 1238	12 mm	3/8"	1	3,54
0524 0812	8 mm	1/2"	1	3,64	0524 1412	14 mm	1/2"	1	3,50
0524 0814	8 mm	1/4"	5	1,87	0524 1438	14 mm	3/8"	1	3,50
0524 0818	8 mm	1/8"	5	1,87	0524 1612	16 mm	1/2"	1	3,02
0524 0838	8 mm	3/8"	1	2,50	0524 1638	16 mm	3/8"	1	3,98





RACORES ROSCADOS / RACCORD FILETÉ / THREAD / FILETTO / CONEXÕES COM ROSCA

Codo / Droit / Elbow / Angolo / Cotovelo



Ref				
0522 0405	4 mm	5mm	5	1,51
0522 0414	4 mm	1/4"	10	1,51
0522 0418	4 mm	1/8"	10	1,51
0522 0605	6 mm	5mm	2	1,51
0522 0612	6 mm	1/2"	2	2,60
0522 0614	6 mm	1/4"	10	1,72
0522 0618	6 mm	1/8"	10	1,61
0522 0638	6 mm	3/8"	5	2,03
0522 0812	8 mm	1/2"	2	2,60
0522 0814	8 mm	1/4"	10	1,98
0522 0818	8 mm	1/8"	10	1,98
0522 0838	8 mm	3/8"	10	2,18
0522 1012	10 mm	1/2"	2	2,65
0522 1014	10 mm	1/4"	10	2,55
0522 1018	10 mm	1/8"	5	2,55
0522 1038	10 mm	3/8"	5	2,55
0522 1212	12 mm	1/2"	2	2,76
0522 1214	12 mm	1/4"	5	2,65
0522 1218	12 mm	1/8"	2	2,65
0522 1238	12 mm	3/8"	5	2,65
0522 1412	14 mm	1/2"	2	5,36
0522 1438	14 mm	3/8"	2	5,36
0522 1612	16 mm	1/2"	1	6,14
0522 1638	16 mm	3/8"	1	8,05

ROSCADO "T" / FILTETE "T" / "T" TYPE FITTING / FILTETTATO "T" / ROSCADA "T"



Ref				
0523 0405	4 mm	5 mm	1	1,51
0523 0414	4 mm	1/4"	5	2,44
0523 0418	4 mm	1/8"	5	2,44
0523 0605	6 mm	5 mm	1	2,44
0523 0612	6 mm	1/2"	1	3,22
0523 0614	6 mm	1/4"	5	3,22
0523 0618	6 mm	1/8"	5	2,96
0523 0638	6 mm	3/8"	5	3,22
0523 0812	8 mm	1/2"	1	3,54
0523 0814	8 mm	1/4"	10	3,22
0523 0818	8 mm	1/8"	10	3,22
0523 0838	8 mm	3/8"	5	3,43
0523 1012	10 mm	1/2"	1	3,59
0523 1014	10 mm	1/4"	5	3,28
0523 1018	10 mm	1/8"	5	3,28
0523 1038	10 mm	3/8"	5	3,48
0523 1212	12 mm	1/2"	1	3,74
0523 1214	12 mm	1/4"	5	3,48
0523 1218	12 mm	1/8"	1	2,66
0523 1238	12 mm	3/8"	2	3,59
0523 1412	14 mm	1/2"	1	5,18
0523 1438	14 mm	3/8"	1	5,18
0523 1612	16 mm	1/2"	1	5,67
0523 1638	16 mm	3/8"	1	5,67

SURTIDO EMERGENCIA RACORES DE PLÁSTICO / ASSORTIMENT URGENCE 38 UNITES / EMERGENCY KIT 38 PCS  
KIT EMERGENZA 38 PEZZI / SORTIDO EMERGÊNCIA 38 PÇS



Ref			
0401 0500	38 pcs	1	35,00
Contenido / Contenu / Contains / Contenuto / Includi			
Ref			
0501 0104	T-4		5
0501 0106	T-6		5
0501 0108	T-8		5
0501 0110	T-10		5
0501 0112	T-12		2
0502 0204	T-4		5
0502 0206	T-6		5
0502 0208	T-8		5
0650 9999	Corta tubo / Coupe tubes / Tube cutter Tagliatubi / Cortador de tubo		1
0940 0221	190 x 155 x 37 mm		1





ES Racores metálicos recuperables de conexión instantánea, adecuados para instalaciones de aire comprimido. Cuerpo totalmente metálico. Fácil visión del calibre del racor. Total seguridad y estanqueidad, incluso en condiciones límites. Resistente a la corrosión. Excelente relación calidad precio.

FR Raccords métalliques à connexion instantanée, adéquats pour les installations d'air comprimé. Corps totalement métallique. Visualisation aisée du diamètre du raccord. Sécurité totale et étanchéité, y compris dans des conditions difficiles. Résistant à la corrosion. Excellent rapport qualité / prix.

EN Metallic fittings with instantaneous joint, suitable for compressed air equipment. Metal body. Easy to see the coupling caliber. Total reliability and tightness, even under extreme conditions. Resistant to corrosion. Excellent relation quality / price.

IT Raccordi metallici con prese rapide, adatti per impianti ad aria compressa. Corpi metallici. Facili da utilizzare, totale affidabilità e tenuta, anche in condizioni estreme. Resistenti alla corrosione. Eccellente rapporto qualità/prezzo.

PT Acessórios metálicos recuperáveis de conexão instantânea, adequado para sistemas de ar comprimido. Corpo todo em metal. Reconhecimento fácil do calibre do encaixe. Total segurança e de vedação, incluindo em condições extremas. Resistente à corrosão. Excelente relação qualidade / preço.

**EMPALME RECTO / RACCORD DROIT / STRAIGHT FITTING / RACCORDO LINEARE / JUNÇÃO RETA**



Ref			
<b>0511 0104</b>	4 mm	10	<b>4,91</b>
<b>0511 0106</b>	6 mm	10	<b>5,08</b>
<b>0511 0108</b>	8 mm	10	<b>5,69</b>
<b>0511 0110</b>	10 mm	5	<b>7,56</b>
<b>0511 0112</b>	12 mm	5	<b>9,65</b>
<b>0511 0114</b>	14 mm	5	<b>12,79</b>

**EMPALME CODO / RACCORD COUDE / ELBOW TYPE FITTING / RACCORDO AD ANGOLO / JUNÇÃO EM COTOVELO**



Ref			
<b>0512 0206</b>	6 mm	5	<b>4,92</b>
<b>0512 0208</b>	8 mm	5	<b>5,34</b>
<b>0512 0210</b>	10 mm	5	<b>7,08</b>
<b>0512 0212</b>	12 mm	5	<b>11,17</b>

**EMPALME EN "T" / RACCORD EN "T" / "T" TYPE FITTING / RACCORDO A "T" / JUNÇÃO EM "T"**



Ref			
<b>0513 0306</b>	6 mm	5	<b>6,42</b>
<b>0513 0308</b>	8 mm	5	<b>7,08</b>
<b>0513 0310</b>	10 mm	5	<b>10,16</b>
<b>0513 0312</b>	12 mm	5	<b>13,99</b>

**ANTIRRETORNO AUTOMÁTICO / ANTI-RETOUR AUTOMATIQUE / AUTOMATIC ANTI-RETURN  
ANTI-RITORNO AUTOMATICO / ANTI-RETORNO AUTOMÁTICO**



Ref			
<b>0627 0001</b>	4 mm	1	<b>11,52</b>
<b>0627 0002</b>	6 mm	1	<b>12,23</b>
<b>0627 0003</b>	8 mm	1	<b>14,80</b>



UNIÓN RECTA REDUCIDA TUBO-TUBO LATÓN NIQUELADO / RACCORD DROIT REDUIT TUBE - TUBE LAITON NICKEL.  
STRAIGHT PLUG-IN REDUCER TUBE-TUBE (NICKEL-PLATED BRASS) / INTERMEDIO DIRITTO TUBO-TUBO, IN OTTONE NICHELATO  
UNIÃO RETA REDUCIDA TUBO-TUBO LATÃO NÍQ.



Ref				
0527 0604	T-6	T-4	1	6,78
0527 0806	T-8	T-6	1	7,65
0527 1008	T-10	T-8	1	8,45

UNIÓN RECTA TUBO-ESPIGA LISA REDUCIDA LATÓN NIQUELADO / RACCORD DROIT TUBE - SAPIN LISSE REDUIT LAITON NICKEL  
STRAIGHT PLUG-IN REDUCER TUBE-STEM (NICKEL-PLATED BRASS) / RACCORDO DRITTO TUBO-CODOLO LISCIÒ A RIDUZIONE, IN OTTONE NICHELATO  
UNIÃO RETA TUBO-ESPIGA LISA REDUZIDA LATÃO NÍQ.



Ref				
0528 0406	T-4	T-6	1	3,96
0528 0604	T-6	T-4	1	2,99
0528 0608	T-6	T-8	1	3,97
0528 0804	T-8	T-4	1	3,07
0528 0806	T-8	T-6	1	3,08
0528 1006	T-10	T-6	1	3,15
0528 1008	T-10	T-8	1	3,35
0528 1206	T-12	T-6	1	3,79
0528 1208	T-12	T-8	1	3,61
0528 1210	T-12	T-10	1	3,17
0528 1408	T-14	T-8	1	5,41
0528 1410	T-14	T-10	1	6,04

UNIÓN EN "Y" TUBO-TUBO LATÓN NIQUELADO / RACCORD EN "Y" TUBE - TUBE LAITON NICKEL. / EQUAL "Y" CONNECTOR TUBE-TUBE (NICKEL-PLATED BRASS)  
RACCORDO A "Y" TUBO-TUBO, IN OTTONE NICHELATO / UNIÃO EM "Y" TUBO-TUBO LATÃO NÍQ.



Ref			
0529 0006	T-6	1	12,50
0529 0008	T-8	1	14,44
0529 0010	T-10	1	21,31

UNIÓN RECTA PASAMUROS TUBO-TUBO LATÓN NIQUELADO / RACCORD DROIT PASSE CLOISON TUBE - TUBE LAITON NICKEL  
BULKHEAD UNION TUBE-TUBE STRAIGHT ADAPTER (NICKEL-PLATED BRASS) / PASSAPARETE TUBO-TUBO, IN OTTONE NICHELATO  
UNIÃO RETA PASSA-MUROS TUBO-TUBO LATÃO NÍQ.

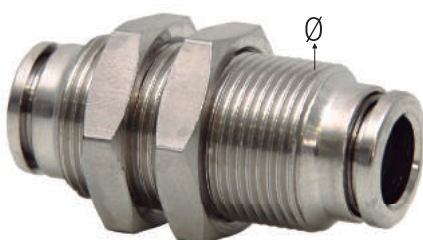

Ref		$\varnothing$		
0526 0004	T-4	11 mm	1	7,39
0526 0006	T-6	11 mm	1	7,39
0526 0008	T-8	17 mm	1	7,65
0526 0010	T-10	17 mm	1	11,09
0526 0012	T-12	20 mm	1	12,89
0526 0014	T-14	24 mm	1	16,31



RACORES RECTO ROSCA MACHO / RACCORD RAPIDE DROIT / STRAIGHT WITH THREAD  
RACCORDO LINEARE / CONEXÃO RETAS ROSCA MACHO



Ref				
0514 0414	4 mm	1/4"	5	2,84
0514 0418	4 mm	1/8"	5	2,62
0514 0614	6 mm	1/4"	5	2,57
0514 0618	6 mm	1/8"	5	2,49
0514 0812	8 mm	1/2"	5	6,50
0514 0814	8 mm	1/4"	5	2,76
0514 0818	8 mm	1/8"	5	2,74
0514 0838	8 mm	3/8"	5	3,44
0514 1012	10 mm	1/2"	5	5,71
0514 1014	10 mm	1/4"	5	3,61
0514 1038	10 mm	3/8"	5	4,06
0514 1212	12 mm	1/2"	5	6,03
0514 1214	12 mm	1/4"	5	4,68
0514 1238	12 mm	3/8"	5	5,13
0514 1412	14 mm	1/2"	5	8,92
0514 1438	14 mm	3/8"	5	8,84

RACOR "T" ROSCA MACHO / RACCORD RAPIDE "T" / "T" TYPE WITH OUTER THREAD  
RACCORDO A "T" / CONEXÃO "T" ROSCA MACHO



Ref				
0517 0418	4 mm	1/8"	1	6,86
0517 0614	6 mm	1/4"	1	7,14
0517 0618	6 mm	1/8"	1	6,31
0517 0814	8 mm	1/4"	1	8,33
0517 0818	8 mm	1/8"	1	8,16
0517 0838	8 mm	3/8"	1	9,76
0517 1014	10 mm	1/4"	1	11,02
0517 1038	10 mm	3/8"	1	12,12

RACOR RECTO ROSCA HEMBRA / DROIT FEMELLE / STRAIGHT WITH INNER THREAD / LINEARE FEMMINA / CONEXÃO RETA ROSCA FÊMEA



Ref				
0515 0414	4 mm	1/4"	1	4,58
0515 0418	4 mm	1/8"	1	4,17
0515 0614	6 mm	1/4"	1	3,92
0515 0618	6 mm	1/8"	1	3,84
0515 0814	8 mm	1/4"	1	4,33
0515 0818	8 mm	1/8"	1	4,25

RACOR CODO ROSCA MACHO / FILETE COUDE / ELBOW TYPE WITH OUTER THREAD FILETTO AD ANGOLO / CONEXÃO COTOVELO ROSCA MACHO



Ref				
0516 0414	4 mm	1/4"	1	5,41
0516 0418	4 mm	1/8"	1	5,48
0516 0614	6 mm	1/4"	1	5,11
0516 0618	6 mm	1/8"	1	5,01
0516 0814	8 mm	1/4"	1	5,46
0516 0818	8 mm	1/8"	1	5,41
0516 0838	8 mm	3/8"	1	6,75
0516 1012	10 mm	1/2"	1	9,52
0516 1014	10 mm	1/4"	1	6,70
0516 1038	10 mm	3/8"	1	7,96
0516 1212	12 mm	1/2"	1	11,31
0516 1214	12 mm	1/4"	1	9,20
0516 1238	12 mm	3/8"	1	9,67
0516 1412	14 mm	1/2"	1	13,72
0516 1438	14 mm	3/8"	1	12,26



CODO HEMBRA-HEMBRA LATÓN NIQUELADO / RACCORD COUDE H - H LAITON NICKEL / F-F ELBOW (NICKEL-PLATED BRASS)  
GOMITO F-F OTTONE NICHELATO / COTOVELO H-H LATÃO DE NÍQUEL



Ref			
0635 0005	M-5	1	2,18
0635 0018	R-1/8"	1	2,13
0635 0014	R-1/4"	1	3,12
0635 0038	R-3/8"	1	4,36
0635 0012	R-1/2"	1	6,65
0635 0034	R-3/4"	1	10,41
0635 0001	R-1"	1	17,80

"T" HEMBRA LATÓN NIQUELADO / RACCORD EN "T" FEMELLE LAITON NICKEL / FEMALE TEE (NICKEL-PLATED BRASS)  
"T" FEMMINATO OTTONE NICHELATO / "T" FÊMEA LATÃO DE NÍQUEL



Ref			
0636 0005	M-5	1	2,87
0636 0018	R-1/8"	1	2,56
0636 0014	R-1/4"	1	3,90
0636 0038	R-3/8"	1	5,36
0636 0012	R-1/2"	1	8,76
0636 0034	R-3/4"	1	15,88
0636 0001	R-1"	1	25,35

VÁLVULA DE BOLA ROSCA HEMBRA / ROBINET D'ARRET FILET FEMALE / BALL VALVE WITH INNER THREAD  
VALVOLA A SFERA FEMMINA / VÁLVULA ESFERA ROSCA FÊMEA



Ref			
0601 0001	1/8	1	8,08
0601 0002	1/4	1	6,34
0601 0003	3/8	1	6,34
0601 0004	1/2	1	7,02
0601 0005	3/4	1	12,41

VÁLVULA DE BOLA ROSCA MACHO / ROBINET D'ARRET FILET MÂLE / BALL VALVE WITH OUTER THREAD  
VALVOLA A SFERA MASCHIO / VÁLVULA ESFERA ROSCA MACHO



Ref			
0602 0001	1/8	1	9,00
0602 0002	1/4	1	9,00
0602 0003	3/8	1	11,41
0602 0004	1/2	1	14,99

VÁLVULA ESFERA HEXAGONAL MACHO-HEMBRA / VALVE SPHÈRIQUE HEXAGONALE M-H / HEXAGONAL MINI BALL VALVE M-F  
VALVOLA A SFERA ESAGONALE M-F / VÁLVULA ESFERA HEXAGONAL M-H



Ref			
0638 0014	R-1/4"	1	6,98
0638 0038	R-3/8"	1	6,98
0638 0012	R-1/2"	1	7,95
0638 0034	R-3/4"	1	12,94

VÁLVULA MINI ESFERA HEMBRA-HEMBRA / VALVE MINI SPHÈRE H-H / MINI BALL VALVE F-F  
VALVOLA A SFERA MICRO F-F / VÁLVULA MINI ESFERA H-H



Ref			
0639 0018	R-1/8"	1	9,50
0639 0014	R-1/4"	1	9,87
0639 0038	R-3/8"	1	12,07
0639 0012	R-1/2"	1	16,49





RACOR RECTO MACHO CÓNICO / RACCORD DROIT MÂLE CONIQUE / STRAIGHT CONIC WITH OUTER THREAD  
RACCORDO LINEARE, CÓNICO / CONEXÃO RETA CÔNICO MACHO

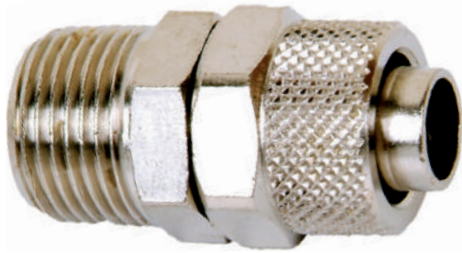

Ref				
0621 0001	4/2	1/8"	5	2,82
0621 0003	4/2,7	1/8"	5	1,63
0621 0004	5/3	1/8"	5	1,72
0621 0005	6/4	1/8"	5	1,49
0621 0006	6/4	1/4"	5	1,59
0621 0007	6/4	3/8"	5	2,49
0621 0008	6/4	1/2"	5	10,62
0621 0009	8/6	1/8"	5	1,97
0621 0010	8/6	1/4"	5	1,68
0621 0011	8/6	3/8"	5	2,40
0621 0012	8/6	1/2"	5	3,93
0621 0013	10/8	1/8"	5	2,10
0621 0014	10/8	1/4"	5	1,94
0621 0015	10/8	3/8"	5	2,41
0621 0016	10/8	1/2"	5	4,11
0621 0017	12/10	3/8"	5	3,07
0621 0018	12/10	1/2"	5	4,13
0621 0019	15/12,5	1/2"	5	5,09

RACOR RECTO CÓNICO MACHO ROSCA MÉTRICA / RACCORD DROIT FILET MÉTRIQUE CONIQUE  
STRAIGHT CONIC FITTING WITH METRIC OUTER THREAD / RACCORDO MASCHIO LINEARE CONICO, FILETTO METRICO  
CONEXÃO RETA CÔNICA MACHO ROSCA MÉTRICA



Ref				
0622 0001	4/2,7	M-5	1	1,88
0622 0003	5/3	M-5	1	1,47
0622 0004	5/3	M-6	1	1,53
0622 0005	6/4	M-5	1	1,53
0622 0006	6/4	M-6	1	1,66
0622 0007	6/4	M-12X1	1	2,91
0622 0008	6/4	M-12X1,25	1	2,56
0622 0009	6/4	M-12X1,5	1	2,56

RACOR CÓNICO ROSCA HEMBRA / RACCORD DROIT FEMALE / STRAIGHT WITH INNER THREAD  
RACCORDO FEMMINA / CONEXÃO CÔNICA ROSCA FÊMEA

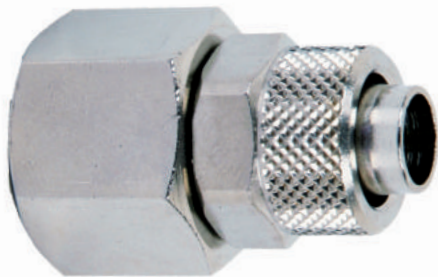

Ref				
0612 0001	5/3	1/8"	1	2,20
0612 0002	6/4	1/8"	1	1,76
0612 0003	6/4	1/4"	1	2,04
0612 0004	6/4	3/8"	1	3,13
0612 0005	8/6	1/8"	1	2,03
0612 0006	8/6	1/4"	1	2,21
0612 0007	8/6	3/8"	1	3,27
0612 0008	8/6	1/2"	1	4,93
0612 0009	10/8	1/8"	1	2,58
0612 0010	10/8	1/4"	1	2,37
0612 0011	10/8	3/8"	1	3,34
0612 0013	10/8	1/2"	1	4,70
0612 0014	12/10	3/8"	1	4,76

RACOR EMPALME CÓNICO DOBLE / RACCORD DROIT INTERMÉDIAIRE CONIQUE / STRAGHT CONIC INTERMEDIATE  
RACCORDO LINEARE INTERMEDIO, CÓNICO / CONEXÃO JUNÇÃO CÔNICA DUPLO

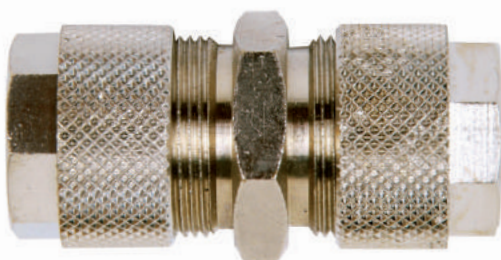

Ref			
0613 0001	4/2,7 - 4/2,7	1	2,79
0613 0002	5/3 - 5/3	1	4,90
0613 0004	6/4 - 6/4	1	2,56
0613 0005	8/6 - 6/4	1	3,08
0613 0006	8/6 - 8/6	1	2,93
0613 0007	10/8 - 6/4	1	4,81
0613 0008	10/8 - 8/6	1	4,91
0613 0009	10/8 - 10/8	1	4,06
0613 0010	12/10 - 12/10	1	5,56
0613 0011	15/12,5 - 15/12,5	1	7,99





RACOR CODO CÓNICO ROSCA MACHO / RACCORD COUDÉ MÂLE CONIQUE / ELBOW CONIC WITH OUTER THREAD  
RACCORDO CONICO AD ANGOLO, MASCHIO / CONEXÃO COTOVELO CÔNICO ROSCA MACHO



Ref				
0614 0001	4/2	1/8"	1	3,47
0614 0003	4/2,5	1/8"	1	2,71
0614 0004	5/3	1/8"	1	2,06
0614 0005	6/4	1/8"	1	2,00
0614 0006	6/4	1/4"	1	2,13
0614 0007	6/4	3/8"	1	3,15
0614 0008	8/6	1/8"	1	2,18
0614 0009	8/6	1/4"	1	2,37
0614 0010	8/6	3/8"	1	3,19
0614 0011	8/6	1/2"	1	6,16
0614 0012	10/8	1/8"	1	3,23
0614 0013	10/8	1/4"	1	2,94
0614 0014	10/8	3/8"	1	3,28
0614 0015	10/8	1/2"	1	5,61
0614 0016	12/10	3/8"	1	4,03
0614 0017	12/10	1/2"	1	5,68
0614 0018	15/12,5	1/2"	1	6,85

RACOR CODO MACHO CÓNICO ROSCA MÉTRICA / RACCORD COUDÉ MÂLE FILET MÉTRIQUE CONIQUE / CONIC ELBOW WITH METRIC OUTER THREAD  
RACCORDO CONICO MASCHIO AD ANGOLO, FILETTO METRICO / CONEXÃO COTOVELO MACHO CÔNICO ROSCA MÉTRICA



Ref				
0615 0001	6/4	M-12x1	1	2,91
0615 0002	6/4	M-12x1,25	1	2,91
0615 0003	6/4	M-12x1,5	1	2,91

CODO INTERMEDIO T4/2,7 / RACCORD COUDÉ INTERMÉDIAIRE T4/2,7 / ELBOW INTERMEDIATE T-4/2,7  
ANGOLATO INTERMEDIO T4/2,7 / CONEXÃO COTOVELO JUNÇÃO CÔNICA T4/2,7



Ref			
0625 0001	4/2,7	1	3,68
0625 0002	5/3	1	2,86
0625 0003	6/4	1	3,06
0625 0005	8/6	1	3,28
0625 0006	10/8	1	3,84
0625 0007	12/10	1	5,75
0625 0008	15/12,5	1	9,05

RACOR "T" CÓNICO ROSCA CENTRAL / RACCORD "T" MÂLE CONIQUE / "T" TYPE CONIC WITH OUTER THREAD  
RACCORDO MASCHIO A "T", CONICO / CONEXÃO "T" CÔNICO ROSCA CENTRAL



Ref				
0623 0001	4/2,7	1/8"	1	3,94
0623 0002	5/3	1/8"	1	3,20
0623 0003	6/4	1/8"	1	3,43
0623 0004	6/4	1/4"	1	4,06
0623 0005	8/6	1/8"	1	3,88
0623 0006	8/6	1/4"	1	4,02
0623 0007	8/6	3/8"	1	5,22
0623 0008	10/8	1/8"	1	4,83
0623 0009	10/8	1/4"	1	4,91
0623 0010	10/8	3/8"	1	5,37
0623 0011	12/10	3/8"	1	6,82
0623 0012	12/10	1/2"	1	9,26
0623 0013	15/12,5	1/2"	1	10,76



RACOR "T" CÓNICO / RACCORD "T" INTERMÉDIAIRE / "T" TYPE INTERMEDIATE  
RACCORDO INTERMEDIO A "T" / CONEXÃO "T" CÔNICO

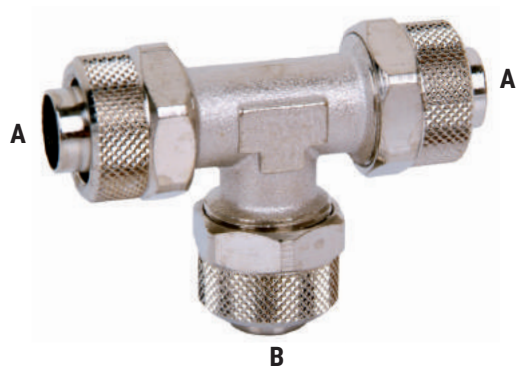

Ref	A	B		
0624 0001	4/2	4/2	1	5,26
0624 0002	4/2,7	4/2,7	1	4,47
0624 0003	5/3	5/3	1	3,81
0624 0004	6/4	6/4	1	4,05
0624 0005	8/6	6/4	1	4,64
0624 0006	8/6	8/6	1	4,75
0624 0007	10/8	6/4	1	7,29
0624 0008	10/8	8/6	1	7,29
0624 0009	10/8	10/8	1	5,13
0624 0010	12/10	12/10	1	8,13
0624 0011	15/2,5	15/2,5	1	12,74

RACOR CRUZ CÓNICO / CROIX INTERMÉDIAIRE / CROSS INTERMEDIATE / RACCORDO INTERMEDIO A CROCE / CONEXÃO EM CRUZ CÔNICA



Ref		
0626 0001	5/3	7,03
0626 0002	6/4	6,30
0626 0003	8/6	7,18
0626 0004	10/8	8,74

RACOR ESPIGA CILÍNDRICA ROSCA MACHO / RACCORD SAPIN CYLINDRIQUE / CYLINDRICAL PIN WITH OUTER THREAD  
RACCORDO A SPIGA CILINDRICA / ESPIGA CILÍNDRICA ROSCA EXTERNA

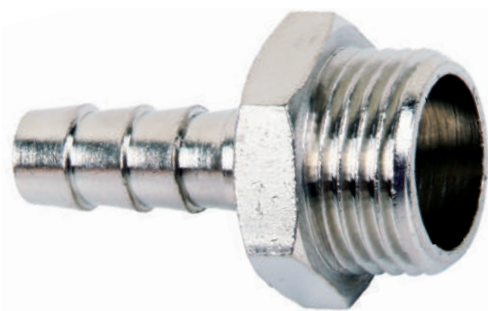

Ref		
0606 0001	T-4,5	2,18
0606 0002	T-6	1,74
0606 0003	T-6	2,06
0606 0004	T-7	2,06
0606 0005	T-7	2,06
0606 0006	T-8	2,06
0606 0007	T-8	2,06
0606 0008	T-8	4,06
0606 0009	T-9	3,33
0606 0010	T-9	2,06
0606 0011	T-9	2,06
0606 0012	T-10	2,15
0606 0013	T-10	2,20
0606 0014	T-10	3,16
0606 0015	T-10	5,16
0606 0016	T-12	2,06
0606 0017	T-12	2,06
0606 0018	T-12	3,49
0606 0019	T-14	2,76
0606 0020	T-14	3,29
0606 0021	T-14	5,29
0606 0022	T-16	3,29
0606 0023	T-16	5,43
0606 0024	T-17	2,62
0606 0025	T-17	3,55
0606 0026	T-20	5,57
0606 0027	T-20	11,45
0606 0028	T-20	12,46
0606 0029	T-25	12,31
0606 0030	T-25	13,60
0606 0031	T-30	14,14
0606 0032	T-30	17,06
0606 0033	T-40	23,94



RACOR PARA TUBO / RACCORD POUTUBE CAOUTCHOUC / HOSE NIPPLE / RACCORDO PER TUBO IN GOMMA / CONEXÃO PARA TUBO

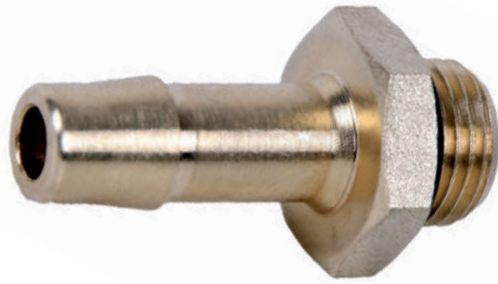

Ref				
0609 0201	13-15	22 x 150	1	7,67
0609 2021	13-15	16 x 150	1	7,22
0609 2034	12-13	22 x 150	1	7,67
0609 2035	12-13	16 x 150	1	7,21
0609 2039	10-11	22 x 150	1	8,22
0609 2040	10-11	16 x 150	1	6,76
0609 0210	8-9	16 x 150	1	7,95
0609 0228	8-9	14 x 150	1	7,33
0609 0223	8-9	12 x 150	1	8,00
0609 0211	6-7	14 x 150	1	7,33

RACOR ESPIGA CILÍNDRICA ROSCA HEMBRA / RACCORD SAPIN FEMELLE / PIN WITH INNER THREAD  
RACCORDO FEMMINA A SPIGA / ESPIGA CILÍNDRICA ROSCA INTERNA

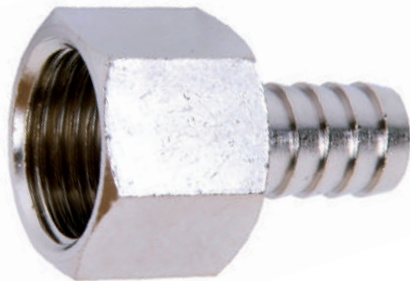

Ref				
0607 0001	T-6	R-1/8"	1	1,97
0607 0002	T-6	R-1/4"	1	2,93
0607 0003	T-7	R-1/8"	1	1,62
0607 0004	T-7	R-1/4"	1	1,72
0607 0005	T-8	R-1/8"	1	2,90
0607 0006	T-8	R-1/4"	1	1,88
0607 0007	T-9	R-1/8"	1	2,90
0607 0008	T-9	R-1/4"	1	1,88
0607 0009	T-9	R-3/8"	1	2,89
0607 0010	T-10	R-1/4"	1	2,54
0607 0011	T-10	R-3/8"	1	2,89
0607 0012	T-10	R-1/2"	1	4,33
0607 0013	T-12	R-1/4"	1	2,55
0607 0014	T-12	R-3/8"	1	2,89
0607 0015	T-12	R-1/2"	1	4,33

ESPIGA LISA MACHO CILÍNDRICA LATÓN NIQUELADO / RACCORD SAPIN LISSE MÂLE CYLINDRIQUE LAITON NICKEL  
MALE STEM ADAPTER (NICKEL-PLATED BRASS) / ADATTATORE CODOLO LISCIO, MASCHIO, CILINDRICO, IN OTTONE NICHELATO  
ADAPTADOR LISO MACHO CILÍNDRICO LATÃO NÍQ.

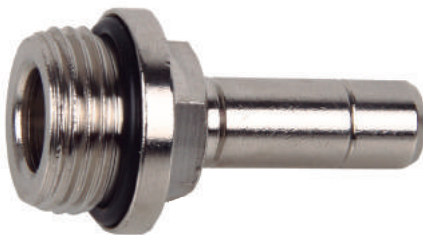

Ref				
0525 0405	T-4	M-5	1	1,26
0525 0407	T-4	M-7	1	1,67
0525 0418	T-4	R-1/8"	1	1,35
0525 0414	T-4	R-1/4"	1	1,51
0525 0605	T-6	M-5	1	1,80
0525 0607	T-6	M-7	1	1,43
0525 0618	T-6	R-1/8"	1	1,26
0525 0614	T-6	R-1/4"	1	1,43
0525 0818	T-8	R-1/8"	1	1,26
0525 0814	T-8	R-1/4"	1	1,43
0525 0838	T-8	R-3/8"	1	2,16
0525 1018	T-10	R-1/8"	1	1,87
0525 1014	T-10	R-1/4"	1	1,98
0525 1038	T-10	R-3/8"	1	2,43
0525 1214	T-12	R-1/4"	1	2,26
0525 1238	T-12	R-3/8"	1	2,80
0525 1212	T-12	R-1/2"	1	3,24
0525 1438	T-14	R-3/8"	1	3,79

ESPIGA DOBLE / RACCORD SAPIN DOUBLE / DOUBLE PIN / RACCORDO DOPPIO A SPIGA / ESPIGA DUPLA



Plástico  
Plastic

Ref			
0608 0001	T-4	10	3,32



Metal

Ref			
0608 0002	T-6	10	2,64
0608 0003	T-7	10	2,71
0608 0004	T-8	10	2,53
0608 0005	T-9	10	3,05
0608 0006	T-10	10	3,05



TAPÓN ALLEN ROSCA MACHO / BOUCHON ALLEN FILET MÂLE / NUT WITH OUTER THREAD  
TAPPO FILETTATO ALLEN, MASCHIO / TAMPÃO ROSCA ALLEN MACHO



Ref	🌀	📦	📊
0616 0001	M-5	5	0,89
0616 0002	R-1/8	5	0,89
0616 0003	R-1/4	5	1,13
0616 0004	R-3/8	5	1,43
0616 0005	R-1/2	5	2,53

TAPÓN ALLEN CÓNICO / BOUCHON CONIQUE ALLEN / CONIC ALLEN NUT / TAPPO CONICO ALLEN / TAMPÃO ALLEN CÔNICO



Ref	🌀	📦	📊
0618 0001	R-1/8"	10	0,61
0618 0002	R-1/4"	10	0,83
0618 0003	R-3/8"	10	1,01
0618 0004	R-1/2"	10	1,62

TAPONES ROSCADOS / BOUCHON D E FERMETURE / THREADED PLUG / TAPPI FILETTATI / TAMPÃO ROSCADO



Ref	🌀	📦	📦	📊
0609 1525	10 x 1,0	8 mm	1	2,76
0609 0189	12 x 1,5	17 mm	1	2,25
0609 0161	14 x 1,5	19 mm	1	2,36
0609 0160	16 x 1,5	21 mm	1	2,36
0609 0178	18 x 1,5	23 mm	1	2,90
0609 0188	20 x 1,5	23 mm	1	2,91
0609 0156	22 x 1,5	27 mm	1	3,12

TAPÓN HEXAGONAL ROSCA MACHO / BOUCHON HEXAGONAL FILET MÂLE / NUT WITH OUTER THREAD  
TAPPO FILETTATO ESAGONALE, MASCHIO / TAMPÃO HEXAGONAL ROSCA MACHO



Ref	🌀	📦	📊
0617 0001	M-5	5	1,36
0617 0002	R-1/8"	5	0,75
0617 0003	R-1/4"	5	0,99
0617 0004	R-3/8"	5	1,33
0617 0005	R-1/2"	5	2,40
0617 0006	R-3/4"	5	3,45
0617 0007	R-1"	5	6,91

TAPÓN HEXAGONAL ROSCA HEMBRA / BOUCHON HEXAGONAL FILET FEMELLE / NUT WITH INNER THREAD  
TAPPO FILETTATO ESAGONALE, FEMMINA / TAMPÃO HEXAGONAL ROSCA FÊMEA



Ref	🌀	📦	📊
0617 0015	M-5	5	0,56
0617 0016	1/8"	5	0,75
0617 0017	1/4"	5	1,27
0617 0018	3/8"	5	1,87
0617 0019	1/2"	5	2,95
0617 0020	3/4"	5	3,70
0617 0021	1"	5	15,55





REDUCCIÓN CILÍNDRICA / RÉDUCTION CYLINDRIQUE / CYLINDRICAL REDUCTION / RIDUZIONE CILINDRICA / REDUÇÃO CILÍNDRICA



Ref	EXTERNAL	INTERNAL		
0619 0001	R -1/8	M-5	5	0,97
0619 0002	R -1/4	R -1/8	5	1,05
0619 0003	R -3/8	R -1/8	5	1,32
0619 0004	R -3/8	R -1/4	5	1,23
0619 0005	R -1/2	R -1/8	5	2,40
0619 0006	R -1/2	R -1/4	5	2,15
0619 0007	R -1/2	R -3/8	5	1,98
0619 0008	R -3/4	R -1/4	5	4,02
0619 0009	R -3/4	R -3/8	5	4,20
0619 0010	R -3/4	R -1/2	5	4,33
0619 0011	R -1"	R -3/8	2	6,66
0619 0012	R -1"	R -1/2	2	6,70
0619 0013	R -1"	R -3/4	2	6,47

PROLONGACIÓN CILÍNDRICA / PROLONGATION CYLINDRIQUE / CYLINDRICAL EXTENTION / ESTENSIONE CILINDRICA / EXTENSÃO CILÍNDRICA



Ref	EXTERNAL	INTERNAL		
0611 0001	5 mm	5 mm	1	1,27
0611 0002	5 mm	1/8"	1	1,12
0611 0003	1/8	1/8	1	1,12
0611 0004	1/8"	1/4"	1	1,31
0611 0005	1/8"	3/8"	1	2,58
0611 0006	1/8"	1/2"	1	5,71
0611 0007	1/4	1/4	1	1,38
0611 0008	1/4"	3/8"	1	2,23
0611 0009	1/4"	1/2"	1	3,71
0611 0010	1/4"	3/4"	1	9,09
0611 0011	3/8	3/8	1	2,32
0611 0012	3/8	1/2"	1	3,44
0611 0013	3/8"	3/4"	1	9,09
0611 0014	1/2	1/2	1	3,85
0611 0015	1/2"	3/4"	1	8,92
0611 0016	1/2"	1"	1	7,96
0611 0017	3/4	3/4	1	5,59
0611 0018	3/4"	1"	1	8,27
0611 0019	1"	1"	1	7,96

REDUCCIÓN MACHO-HEMBRA / RÉDUCTEUR MALE-FEMELLE / TRANSFER ADAPTER MALE-FEMALE  
RIDUTTORE MASCHIO-FEMMINA / REDUTOR MACHO-FÊMEA



Ref	EXTERNAL	INTERNAL		
0609 0150	22 x 1,5	1/2 GAS	1	7,25
0609 1502	16 x 1,5	3/8 GAS	1	7,30
0609 0175	22 x 1,5	18 x 1,5	1	3,97
0609 0164	22 x 1,5	16 x 1,5	1	3,97
0609 0206	16 x 1,5	22 x 1,5	1	7,24
0609 0219	16 x 1,0	22 x 1,5	1	6,77
0609 0169	22 x 1,5	16 x 1,0	1	3,97
0609 0167	22 x 1,5	14 x 1,5	1	3,97
0609 0174	22 x 1,5	12 x 1,5	1	3,97
0609 0176	22 x 1,5	1/4 GAS	1	3,97
0609 0186	22 x 1,5	3/8 GAS	1	3,97
0609 0191	22 x 1,5	1/8 GAS	1	5,99
0609 0192	20 x 1,5	1/8 GAS	1	5,99
0609 0193	20 x 1,5	1/4 GAS	1	6,06
0609 0194	20 x 1,5	3/8 GAS	1	6,06
0609 0196	18 x 1,5	1/8 GAS	1	6,06
0609 0197	18 x 1,5	1/4 GAS	1	6,06
0609 0500	16 x 1,5	1/8 GAS	1	5,85
0609 0504	14 x 1,5	1/8 GAS	1	5,95
0609 0517	16 x 1,5	10 x 1,0	1	6,19





MACHÓN CILÍNDRICO DE REDUCCIÓN / RACCORD CYLINDRIQUE DE RÉDUCTION / CYLINDRICAL ADAPTER DOUBLE OUTER  
THREAD RACCORDO RIDUZIONE CILINDRICO / REDUTOR CILÍNDRICO MACHO



Ref	EXTERNAL	INTERNAL		
0610 0001	M-5	1/8"	5	1,09
0610 0002	1/8"	1/4"	5	1,31
0610 0003	1/8"	3/8"	5	1,50
0610 0004	1/8"	1/2"	5	4,87
0610 0005	1/4"	3/8"	5	1,55
0610 0006	1/4"	1/2"	5	2,58
0610 0007	1/4"	3/4"	5	7,14
0610 0008	3/8"	1/2"	5	2,84
0610 0009	3/8"	3/4"	2	7,33
0610 0010	1/2"	3/4"	2	4,98
0610 0011	1/2"	1"	2	9,02
0610 0012	3/4"	1"	2	6,47

MACHÓN CILÍNDRICO ROSCAS IGUALES / RACCORD CYLINDRIQUE FILETAGE IDENTIQUE / CYLINDRICAL FITTING SAME THREADS  
RACCORDO CILINDRICO, FILETTATURA BILATERALE UGUALE / ENCAIXE CILÍNDRICO ROSCAS IGUAIS



Ref			
0609 0001	5 mm	10	0,69
0609 0002	1/8"	10	0,91
0609 0003	1/4"	10	1,36
0609 0004	3/8"	10	1,79
0609 0005	1/2"	10	2,80
0609 0006	3/4"	5	5,20
0609 0007	1"	5	6,39

EMPALME DOBLE MACHO / RACCORD DOUBLE MALE / TRANSFER ADAPTER FEMALE - FEMALE  
ADATTATORE MASCHIO - MASCHIO / ADAPTADOR DUPLO MACHO



Ref				
0631 2626	26 x 150	26 x 150	1	10,77
0631 2226	22 x 150	26 x 150	1	11,26
0631 2222	22 x 150	22 x 150	1	4,84
0631 2218	22 x 150	18 x 150	1	5,26
0631 2216	22 x 150	16 x 150	1	6,34
0631 2214	22 x 150	14 x 150	1	6,08
0631 2212	22 x 150	12 x 150	1	6,08
0631 2210	22 x 150	10 x 150	1	6,18
0631 1618	16 x 150	18 x 150	1	5,46
0631 1616	16 x 150	16 x 150	1	5,20
0631 0233	16 x 150	16 x 100	1	5,63
0631 1614	16 x 150	14 x 150	1	5,63
0631 1612	16 x 150	12 x 150	1	4,96
0631 1414	14 x 150	14 x 150	1	5,03
0631 1412	14 x 150	12 x 150	1	5,74
0631 1212	12 x 150	12 x 150	1	5,26
0631 1012	12 x 150	10 x 100	1	9,98
0631 2201	22 x 150	1/4" gas	1	7,15



PASAMUROS ROSCADO / PASSE CLOISON FILETE / THREADED BULKHEAD / PASSAPARETE FILETTATO / PASSAMUROS ROSCADO



Ref	🌀	📦	📊
0632 0202	22 x 150	1	7,82
0632 2045	18 x 150	1	8,37
0632 0214	16 x 150	1	7,64
0632 0224	16 x 100	1	6,97
0632 0209	14 x 150	1	7,72

PASATABIQUES LATÓN NIQUELADO / RACCORD TRAVERSANT LAITON NICKEL / NICKEL-PLATED BRASS BULKHEAD  
PASSAPARETE OTTONE NICHELETA / UNIÃO P/ PAINEL LATÃO DE NÍQUEL



Ref	🌀	Ø	📦	📊
0637 0510	5 mm	M-10x1	1	1,95
0637 1816	R-1/8"	M-16x1,5	1	3,04
0637 1420	R-1/4"	M-20x1,5	1	5,42
0637 3826	R-3/8"	M-26x1,5	1	9,56
0637 1228	R-1/2"	M-28x1,5	1	10,41

CONVERTIDOR MACHO-HEMBRA / ADAPTATEUR MALE - FEMELLE / SOCKET JOIN MALE - FEMALE  
CONVERTITORE MASCHIO-FEMMINA / SOQUETE DE JUNÇÃO MACHO-FÊMEA



Ref	🌀	📦	📊
0609 0722	22 x 150	1	7,23
0609 0816	16 x 150	1	5,68
0609 0814	14 x 150	1	2,96

MANGUITO HEMBRA-HEMBRA LATÓN NIQUELADO / RACCORD H - H LAITON NICKEL / BULKHEAD FITTING F-F (NICKEL-PLATED BRASS)  
MANICOTTO F-F OTTONE NICHELATO / CONEXÃO H-H LATÃO DE NÍQUEL



Ref	🌀	📦	📊
0633 0005	M-5	1	0,86
0633 0018	R-1/8"	1	1,12
0633 0014	R-1/4"	1	1,50
0633 0038	R-3/8"	1	2,45
0633 0012	R-1/2"	1	3,89
0633 0034	R-3/4"	1	6,63
0633 0001	R-1"	1	8,45

MANGUITO HEMBRA-HEMBRA REDUCIDO LATÓN NIQUELADO / RACCORD H - H REDUCTION LAITON NICKEL  
REDUCED BULKHEAD FITTING F-F (NICKEL-PLATED BRASS) / MANICOTTO RIDOTTO F-F OTTONE NICHELATO  
CONEXÃO H-H REDUZIDO LATÃO NÍQ.



Ref	🌀	🌀	📦	📊
0634 0518	M-5	R-1/8"	1	1,38
0634 1814	M-1/8"	R-1/4"	1	1,58
0634 1838	M-1/8"	R-3/8"	1	2,26
0634 1812	M-1/8"	R-1/2"	1	3,35
0634 1438	M-1/4"	R-3/8"	1	2,47
0634 1412	M-1/4"	R-1/2"	1	3,23
0634 3812	M-3/8"	R-1/2"	1	3,64
0634 3834	M-3/8"	R-3/4"	1	5,66
0634 1234	M-1/2"	R-3/4"	1	9,28
0634 1201	M-1/2"	R-1"	1	8,09
0634 3401	M-3/4"	R-1"	1	11,60



RACOR DE INFLAR / RACCORD DE GONFLAGE / INFLATING CONNECTOR / RACCORDO DI GONFIAGGIO / CONECTOR DE INFLAR

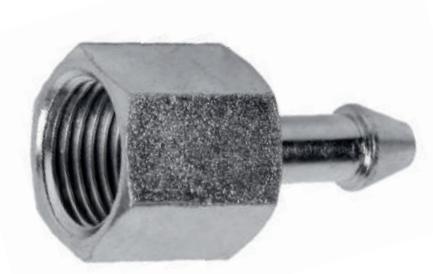

Ref				
0606 0775	T-8	16 x 1,5	1	16,19

GRIFO DE PURGA / GRIFFE DE PURGE / PETCOCK / VALVOLA DI SPURGO / VÁLVULA DE PURGA



Ref			
0629 0401	22 x 1,5	1	5,72

TUERCA HEMBRA / EROU FEMELLE / INNER THREADED NUT / GHIERA FILETTATA / PORCA FÊMEA



Ref			
0620 0001	1/8"	10	0,63
0620 0002	1/4"	10	0,71
0620 0003	3/8"	10	0,82
0620 0004	1/2"	10	1,14
0620 0005	3/4"	5	1,50
0620 0006	1"	5	1,97

TUERCA FIJACIÓN / EROU FIXATION / LOCKING NUT / DADO DI FISSAGGIO / PORCA DE FIXAÇÃO

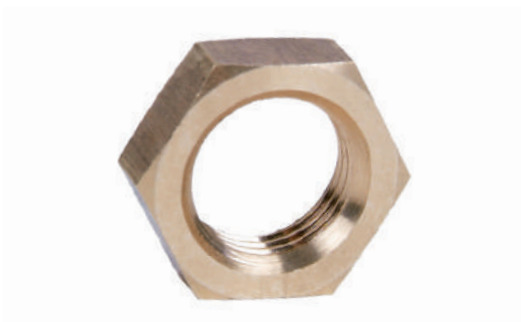

Ref			
0610 0168	12 x 1,50	1	1,51
0610 0159	14 x 1,50	1	1,51
0610 0158	16 x 1,50	1	1,51
0610 1516	18 x 1,50	1	1,86
0610 0155	22 x 1,50	1	2,24

TUERCA FIJACIÓN JUNTA TÓRICA / EROU FIXATION AVEC CAOUTCHOUC / LOCKING NUT WITH O-RING  
DADO DI FISSAGGIO CON GUARNIZIONE TORICA / PORCA DE FIXAÇÃO JUNTA TÓRICA



Ref			
0612 0012	12 x 1,50	1	4,17
0612 0016	16 x 1,50	1	3,76
0612 0018	18 x 1,50	1	4,27
0612 0022	22 x 1,50	1	4,27



FORRO ANTICHAFABLE / FOURREAU TUBE / INTERNAL SUPPORT / BOCCOLA INTERNA / SUPORTE INTERNO



Ref			
0628 0004	4 mm	1	1,09
0628 0005	5 mm	1	1,12
0628 0006	6 mm	1	1,03
0628 0007	7 mm	1	1,14
0628 00075	7,5 mm	1	1,25
0628 0008	8 mm	1	1,09
0628 0009	9 mm	1	1,68
0628 0010	10 mm	1	1,20
0628 0011	11 mm	1	1,43
0628 0012	12 mm	1	1,43
0628 0013	13 mm	1	1,48
0628 0014	14 mm	1	4,70

ANILLO DE CIERRE NORMAL / ANNEAU DE FERMETURE NORMAL / CLOSING RING / ANELLO DI CHIUSURA NORMALE / ANEL DE FECHO NORMAL



Ref		A		
0630 0004	4 mm	6 mm	1	0,71
0630 0005	5 mm	7 mm	1	1,24
0630 0006	6 mm	7 mm	1	0,80
0630 0008	8 mm	7 mm	1	0,82
0630 0009	9 mm	7 mm	1	1,19
0630 0010	10 mm	7 mm	1	0,93
0630 0011	11 mm	7 mm	1	1,19
0630 0012	12 mm	7 mm	1	0,88
0630 0014	14 mm	10 mm	1	1,63
0630 0015	15 mm	10 mm	1	1,35
0630 0016	16 mm	10 mm	1	1,61
0630 0017	17 mm	10 mm	1	1,29
0630 0018	18 mm	10 mm	1	1,29

ANILLO DE CIERRE LARGO / ANNEAU DE FERMETURE LARGE / LONG CLOSING RING / ANELLO DI CHIUSURA LUNGO / ANEL FECHO LONGO



Ref		A		
0630 0126	6 mm	9 mm	1	0,88
0630 0128	8 mm	9 mm	1	0,88
0630 0130	10 mm	10 mm	1	0,93
0630 0132	12 mm	10 mm	1	0,96

RACOR RECTO / RACCORD DROIT / STRAIGHT FITTING / RACCORDO LINEARE / CONEXÃO RETA



Ref				
0627 0106	6 mm	12 x 1,5	1	10,32
0627 0108	8 mm	14 x 1,5	1	9,88
0627 0110	10 mm	16 x 1,5	1	11,44
0627 0112	12 mm	18 x 1,5	1	12,95
0627 0114	14 mm	20 x 1,5	1	12,69
0627 0115	15 mm	22 x 1,5	1	17,89
0627 0116	16 mm	22 x 1,5	1	17,65
0627 0118	18 mm	26 x 1,5	1	23,40

RACOR CURVO / RACCORD COUDE / ELBOW TYPE FITTING / CURVATO / CONEXÃO TIPO DE COTOVELO



Ref				
0627 0206	6 mm	12 x 1,5	1	18,85
0627 0208	8 mm	14 x 1,5	1	21,28
0627 0210	10 mm	16 x 1,5	1	21,28
0627 0212	12 mm	18 x 1,5	1	20,27
0627 0215	15 mm	22 x 1,5	1	22,96





RACOR METÁLICO "T" / RACCOR METALLIQUE "T" / "T" TYPE METALLIC / METALLICO A "T" / CONEXÃO METÁLICA EM "T"



Ref				
0627 0306	6 mm	12 x 1,5	1	22,52
0627 0308	8 mm	14 x 1,5	1	23,25
0627 0310	10 mm	16 x 1,5	1	24,40
0627 0312	12 mm	18 x 1,5	1	26,83
0627 0315	15 mm	22 x 1,5	1	34,70

RACOR DE PRUEBA / RACCOR D'ESSAI / TEST POINT / RACCORDI PUNTO DI MISURA / CONEXÃO DE PROVA



Ref			
0606 0776	16 x 1,5	1	6,71
0606 0777	22 x 1,5	1	7,11

CONECTOR MACHO TUBO MILÍMETROS / RACCOR SAPIN RÉDUCTION / MALE COUPLING  
CONNETTORE MASCHIO METRICO / CONECTOR MACHO TUBO MILÍMETROS

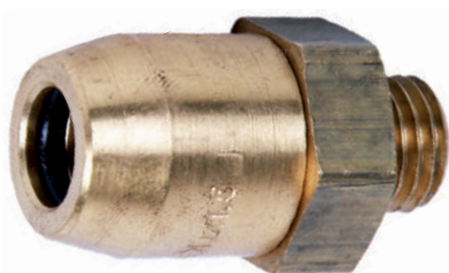

Ref				
0601 0190	4 x 1	10 x 100	1	14,82
0601 0192	4 x 1	12 x 1,5	1	12,22
0601 0210	6 x 1	10 x 100	1	5,51
0601 0212	6 x 1	12 x 1,5	1	5,51
0601 0214	6 x 1	14 x 1,5	1	5,98
0601 0216	6 x 1	16 x 1,5	1	6,40
0601 0217	6 x 1	22 x 1,5	1	8,06
0601 0230	8 x 1	10 x 100	1	4,94
0601 0232	8 x 1	12 x 1,5	1	5,04
0601 0234	8 x 1	14 x 1,5	1	5,46
0601 0236	8 x 1	16 x 1,5	1	5,77
0601 0237	8 x 1	22 x 1,5	1	7,49
0601 0300	10 x 1	10 x 100	1	6,19
0601 0302	10 x 1	12 x 1,5	1	5,98
0601 0304	10 x 1	14 x 1,5	1	6,14
0601 0306	10 x 1	16 x 1,5	1	6,50
0601 0307	10 x 1	22 x 1,5	1	8,01
0601 0312	10 x 1,25	12 x 1,5	1	6,03
0601 0314	10 x 1,25	14 x 1,5	1	6,03
0601 0316	10 x 1,25	16 x 1,5	1	6,55
0601 0317	10 x 1,25	22 x 1,5	1	8,06
0601 0332	10 x 1,5	12 x 1,5	1	6,88
0601 0334	10 x 1,5	14 x 1,5	1	6,66
0601 0336	10 x 1,5	16 x 1,5	1	6,55
0601 0337	10 x 1,5	22 x 1,5	1	7,75
0601 0370	12 x 1,5	10 x 100	1	6,66
0601 0372	12 x 1,5	12 x 1,5	1	5,82
0601 0374	12 x 1,5	14 x 1,5	1	6,76
0601 0376	12 x 1,5	16 x 1,5	1	6,92
0601 0377	12 x 1,5	22 x 1,5	1	8,53
0601 0446	15 x 1,5	16 x 1,5	1	9,72
0601 0447	15 x 1,5	22 x 1,5	1	10,04
0601 0448	15 x 2	16 x 1,5	1	9,83
0601 0449	15 x 2	22 x 1,5	1	12,04
0601 0456	16 x 2	16 x 1,5	1	10,56
0601 0457	16 x 2	22 x 1,5	1	10,71
0601 0477	18 x 2	22 x 1,5	1	11,23





CONECTOR MACHO TUBO PULGADAS / CONNECTEUR MÉTRIQUE MALE / INCH MALE COUPLING  
CONNETTORE MASCHIO IN POLLICI / CONECTOR MACHO TUBO POLEGADAS

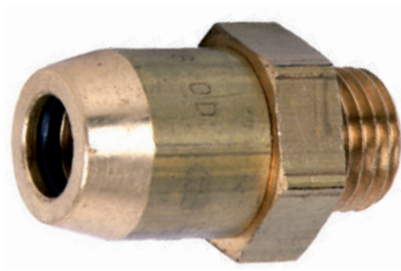

Ref				
0601 0110	1/4"	10 x 100	1	21,16
0601 0112	1/4"	12 x 1,5	1	11,50
0601 0114	1/4"	14 x 1,5	1	49,19
0601 0116	1/4"	16 x 1,5	1	13,07
0601 0130	3/8"	10 x 100	1	40,92
0601 0132	3/8"	12 x 1,5	1	36,87
0601 0134	3/8"	14 x 1,5	1	43,27
0601 0136	3/8"	16 x 1,5	1	11,40
0601 0152	1/2"	12 x 1,5	1	19,05
0601 0156	1/2"	16 x 1,5	1	12,32
0601 0176	5/8"	16 x 1,5	1	21,18

PIVOTE GIRATORIO A5 / CONNECTEUR MÉTRIQUE POUCES A5 / A5 REVOLVING PLUG-IN / CONNETTORE ROTONDO A5 / CONECTOR ROTATIVO A5



Ref			
0602 0010	10 x 100	1	5,03
0602 0012	12 x 1,5	1	3,54
0602 0014	14 x 1,5	1	3,80
0602 0016	16 x 1,5	1	4,21
0602 0017	22 x 1,5	1	5,93

CONECTOR DOBLE / CONNECTEUR DOUBLE / DOUBLE PUSH-IN COUPLING / CONNETTORE DOPPIO / CONECTOR DUPLO

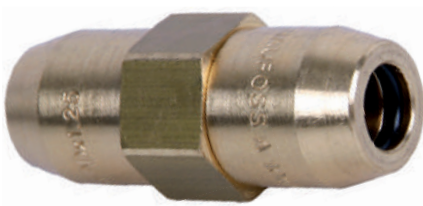

Ref				
0601 0205	6 x 1	6 x 1	1	8,11
0601 0225	8 x 1	8 x 1	1	8,63
0601 0305	10 x 1	10 x 1	1	10,35
0601 0315	10 x 1,25	10 x 1,25	1	10,35
0601 0325	10 x 1,5	10 x 1,5	1	10,35
0601 0355	11 x 1,5	11 x 1,5	1	32,05
0601 0365	12 x 1,5	12 x 1,5	1	12,43
0601 0445	15 x 1,5	15 x 1,5	1	16,95

TUERCA HEMBRA / ECROU FEMELLE / INNER THREADED NUT / GHIERA FILETTATA / PORCA FÊMEA



Ref			
0604 0863	16 x 1,5	1	11,50

CODO CON 3 BOCAS + A5 / COUDÉ 3 ENTRÉES / 3 WAY-BLOCK + A5 / ANGOLO A 3 VIE + A5 / COTOVELO COM 3 BOCAS + A5



Ref			
0604 0846	16 x 1,5	1	11,46



CODO 45° + A5 / COUDÉ 45° + A5 / 45° ELBOW + A5 / ANGOLO 45° + A5 / COTOVELO 45° + A5



Ref			
0604 0832	16 x 1,5	1	9,83

CODO CONECTOR 90° + A5 / COUDE 90° + A5 / 90° ELBOW COUPLING + A5 / CONNETTORE ANGOLARE 90° + A5 / COTOVELO CONECTOR 90° + A5



Ref			
0603 0610	6 x 1	1	8,42
0603 0810	8 x 1	1	8,16
0603 1010	10 x 1	1	8,53
0603 1012	10 x 1,25	1	8,63
0603 1015	1 x 1,5	1	8,63
0603 1215	12 x 1,5	1	8,79
0603 1515	15 x 1,5	1	11,44
0603 1620	16 x 2	1	11,65

CODO CON ROSCAS / COUDE FILETÉ / ELBOW FITTING OUTER THREAD / ANGOLO CON FILETTO / COTOVELO COM ROSCAS



Ref			
0604 0823	12 x 1,5	1	8,84
0604 0862	16 x 1,5	1	5,72
0604 0865	18 x 1,5	1	8,70
0604 0867	22 x 1,5	1	7,75

"T" ROSCADA / "T" FILETÉ / UNION "T" / "T" FILETTATO / EM "T" ROSCADA



Ref			
0604 0825	12 x 1,5	1	6,71
0604 0864	16 x 1,5	1	6,71
0604 0868	22 x 1,5	1	10,11

CRUZ + A5 / CROIX + A5 / CROSS-BLOCK + A5 / CROCE + A5 / EM CRUZ + A5



Ref			
0604 0838	16 x 1,5	1	10,03



RACOR CODO ROSCA MACHO / RACCORD COUDÉ FILETÉ MALE / THREADED ELBOW FITTING  
RACCORDO AD ANGOLO, FILETTO MASCHIO / CONECTOR COTOBELLO ROSCA MACHO



Ref				
<b>0605 0807</b>	12 x 1,5	12 x 1,5	1	<b>7,70</b>
<b>0605 0808</b>	16 x 1,5	16 x 1,5	1	<b>7,70</b>
<b>0605 0809</b>	16 x 1,5	22 x 1,5	1	<b>7,85</b>

CRUZ ROSCADA / CROIX FILETÉE / THREADED CROSS FITTING / CROCE FILETTATA / EM CRUZ ROSCADO



Ref			
<b>0604 0827</b>	12 x 1,5	1	<b>27,09</b>
<b>0604 0828</b>	16 x 1,5	1	<b>12,84</b>

"T" ROSCADA + A5 / "T" FILETÉ + A5 / UNION "T" + A5 / "T" FILETTATA + A5 / "T" ROSCADA + A5



Ref			
<b>0604 0804</b>	12 x 1,5	1	<b>6,45</b>
<b>0604 0834</b>	16 x 1,5	1	<b>6,71</b>

"T" + A5 CENTRAL / "T" + A5 CENTRAL / UNION "T" + A5 CENTRAL / "T" FILETTATA + A5 CENTRALE / "T" + A5 CENTRAL



Ref			
<b>0604 0805</b>	12 x 1,5	1	<b>6,45</b>
<b>0604 0835</b>	16 x 1,5	1	<b>6,76</b>

"T" 3 BOCAS + A5 CENTRAL / "T" 3 ENTRÉES + A5 CENTRAL / 3 WAY-BLOCK "T" + A5 CENTRAL / "T" 3 VIE + A5 CENTRALE / "T" 3 VÍAS + A5 CENTRAL



Ref			
<b>0604 0837</b>	16 x 1,5	1	<b>11,63</b>



"T" 3 BOCAS + A5 LATERAL / "T" 3 ENTRÉES + A5 LATÉRAL / 3 WAY-BLOCK "T" + A5 LATERAL / "T" 3 VIE + A5 LATERALE / "T" 3 VÍAS + A5 LATERAL



Ref			
<b>0604 0839</b>	16 x 1,5	1	<b>14,24</b>

CODO ROSCA + A5 / COUDE FILETÉ + A5 / ELBOW THREAD + A5 / ANGOLO FILETTATO + A5 / COTOVELO ROSCA + A5



Ref			
<b>0604 0803</b>	12 x 1,5	1	<b>5,62</b>
<b>0604 0833</b>	16 x 1,5	1	<b>5,72</b>

MALETÍN RACORERÍA METÁLICA / VALISETTE RACCORDS MÉTALLIQUES RAUFOSS / RAUFOSS METALLIC FITTINGS BOX  
VALIGETTA RACCORDI METALLICI RAUFOSS / CAIXA CONEXÕES METÁLICAS RAUFOSS

Ref			
<b>0401 0601</b>	94	1	<b>518,81</b>

Contenido / Contenu / Contains / Contenuto / Inclui



Ref	M	
0604 0864	16 x 1,5mm	2 uds
0601 0232	12 x 1,5mm	8 uds
0601 0377	22 x 1,5mm	6 uds
0601 0447	22 x 1,5mm	4 uds
0601 0376	16 x 1,5mm	6 uds
0601 0236	16 x 1,5mm	6 uds
0604 0835	16 x 1,5mm	4 uds
0604 0832	16 x 1,5mm	4 uds
0604 0833	16 x 1,5mm	4 uds
0602 0017	22 x 1,5mm	4 uds
0602 0016	16 x 1,5mm	4 uds
0602 0012	12 x 1,5mm	4 uds
0604 0862	16 x 1,5mm	4 uds
0606 0776	16 x 1,5mm	4 uds
0606 0777	22 x 1,5mm	4 uds
0609 0816	16 x 1,5mm	8 uds
0609 0156	22 x 1,5mm	4 uds
0609 0160	16 x 1,5mm	4 uds
0609 0189	12 x 1,5mm	4 uds
0632 0202	22 x 1,5mm	3 uds
0632 0224	16 x 100mm	3 uds
0940 0223	364 x 268 x 66 mm	1 uds



KIT TOMA PRESIÓN ITV / KITS PRISE DE PRESSION ITV / AIR BRAKE FITTING KITS MOT  
KIT RACCORDI PRESE DI PRESSIONE ITV / KITS TOMADA DE PRESSÃO ITV

**KIT 1**



Ref		
<b>0601 9002</b>	1	<b>40,51</b>

Pasamuros / Passe cloison / Metallic fitting bulkhead  
Isolante / Glândula de cabo

8 mm	22 x 1,5

Te / TE / T-Fitting / Te / Te

8 mm	16 x 1,5

ES Fabricados de una sola pieza según legislación vigente.

FR Fabriqués en une seule pièce selon la législation en vigueur.

EN Made of one single piece pursuant to applicable law.

IT Fabbricati in un unico componente in base alla normativa vigente.

PT Fabricados de uma única peça de acordo com a legislação em vigor.

KIT TOMA PRESIÓN ITV / KITS PRISE DE PRESSION ITV / AIR BRAKE FITTING KITS MOT  
KIT RACCORDI PRESE DI PRESSIONE ITV / KITS TOMADA DE PRESSÃO ITV

**KIT 2**



Ref		
<b>0601 9007</b>	1	<b>42,64</b>

Pasamuros / Passe cloison / Metallic fitting bulkhead  
Isolante / Glândula de cabo

8 mm	18 x 1,5

Te / TE / T-Fitting / Te / Te

8 mm	16 x 1,5

ES Fabricados de una sola pieza según legislación vigente.

FR Fabriqués en une seule pièce selon la législation en vigueur.

EN Made of one single piece pursuant to applicable law.

IT Fabbricati in un unico componente in base alla normativa vigente.

PT Fabricados de uma única peça de acordo com a legislação em vigor.

KIT TOMA PRESIÓN ITV / KITS PRISE DE PRESSION ITV / AIR BRAKE FITTING KITS MOT  
KIT RACCORDI PRESE DI PRESSIONE ITV / KITS TOMADA DE PRESSÃO ITV

**KIT 3**



Ref		
<b>0601 9010</b>	1	<b>51,17</b>

Pasamuros / Passe cloison / Metallic fitting bulkhead  
Isolante / Glândula de cabo

8 mm	22 x 1,5

Te / TE / T-Fitting / Te / Te

Macho: 22/150 - Hembra: 16/150  
Mâle: 22/150 - Femelle: 16/150  
Male: 22/150 - Female: 16/150  
Maschio: 22/150 - Femmina: 16/150  
Macho: 22/150 - Fêmea: 16/150

ES Fabricados de una sola pieza según legislación vigente.

FR Fabriqués en une seule pièce selon la législation en vigueur.

EN Made of one single piece pursuant to applicable law.

IT Fabbricati in un unico componente in base alla normativa vigente.

PT Fabricados de uma única peça de acordo com a legislação em vigor.





CABEZAS DE ACOPLAMIENTO / TETES D'ACCOUPLLEMENT / COUPLINGS / TESTINE DI ACCOPPIAMENTO / ACOPLAMENTOS

**AUTOMÁTICO**



Ref					
284 311 221	Automático	16 x 1,50	■	1	11,50
229 311 211	Automático	22 x 1,50	■	1	11,50
284 311 222	Automático	16 x 1,50	■	1	11,50
229 311 212	Automático	22 x 1,50	■	1	11,50

**ESTÁNDAR**



Ref					
229 311 021	Estándar	16 x 1,50	■	1	8,90
229 311 011	Estándar	22 x 1,50	■	1	8,90
229 311 022	Estándar	16 x 1,50	■	1	8,90
229 311 012	Estándar	22 x 1,50	■	1	8,90

VÁLVULA DE BOLA DE PASO TOTAL - PN-25 / VANNE OUVERTURE TOTALE / BALL VALVE-FULLY OPENED WAY  
VALVOLA A SFERA / VÁLVULA DE ESFERA MODO ABERTO

**PN-25**



Ref			
0603 0001	1/4"	1	3,74
0603 0002	3/8"	1	3,90
0603 0017	1/2"	1	5,30
0603 0018	3/4"	1	7,60
0603 0019	1"	1	11,95
0603 0020	1"1/4"	1	20,02
0603 0021	1"1/2"	1	30,84
0603 0022	2"	1	41,50
0603 0023	2"1/2"	1	85,80
0603 0024	3"	1	138,00
0603 0025	4"	1	176,96

GRIFO VÁLVULA DE BOLA MANETA PARA MANGUERA / VANNE OUVERTURE POUR TUYAU / BALL VALVE TAP FOR HOSES  
VALVOLA A SFERA, RACCORDO PER TUBAZIONE / TORNEIRA VALVULA DE ESFERA PARA MANGUEIRA





Ref			
0604 0001	1/2x3/4"	1	5,15
0604 0002	3/4x1"	1	6,95
0604 0003	1"x1"	1	14,51



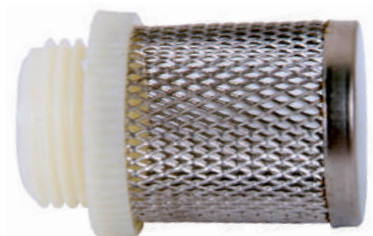



FILTRO VÁLVULA YORK / FILTRE VALVE YORK / YORK VALVE FILTER / FILTRO VALVOLA YORK / FILTRO VÁLVULA YORK

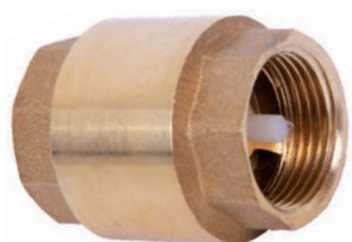

Ref			
<b>0629 0002</b>	1/2"	2	<b>1,27</b>
<b>0629 0003</b>	3/4"	2	<b>1,57</b>
<b>0629 0004</b>	1"	2	<b>2,39</b>
<b>0629 0005</b>	1"1/4"	2	<b>2,69</b>
<b>0629 0006</b>	1"1/2"	2	<b>3,63</b>





VÁLVULA DE RETENCIÓN YORK / VALVE DE RÉTENTION YORK / YORK NON RETURN VALVE  
VALVOLA DI TENUTA YORK / VÁLVULA DE RETENÇÃO YORK

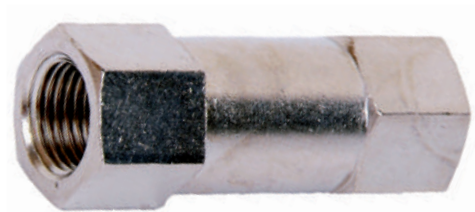

Ref			
<b>0628 0016</b>	1/2"	1	<b>4,26</b>
<b>0628 0017</b>	3/4"	1	<b>5,82</b>
<b>0628 0018</b>	1"	1	<b>8,50</b>
<b>0628 0019</b>	1"1/4"	1	<b>13,36</b>
<b>0628 0020</b>	1"1/2"	1	<b>18,46</b>

ANTIRRETORNO / ANTI-RETOUR / ANTI-RETURN / ANTI-RITORNO / ANTI-RETORNO



Ref				
<b>0605 0001</b>	M-5	M-5	1	<b>7,44</b>
<b>0605 0002</b>	1/8"	1/8"	1	<b>7,75</b>
<b>0605 0003</b>	1/4"	1/4"	1	<b>9,15</b>
<b>0605 0004</b>	3/8"	3/8"	1	<b>15,24</b>
<b>0605 0005</b>	1/2"	1/2"	1	<b>19,81</b>



CONEXIÓN FLEXIBLE INOX MACHO - HEMBRA / CONNEXION FLEX. INOX MALE - FEMELLE / ST. STEEL FLEX. CONNECTION MALE - FEMALE  
CONNESSIONE FLESSIBILE IN INOX MASCHIO - FEMMINA / CONEXÃO FLEXÍVEL INOX MACHO - FÊMEA



Ref						
0820 2001	M1/2"-H3/8"	20 cm	1	10	2,66	✓
0820 2002	M3/8"- H1/2"	20 cm	1	10	2,52	✓
0820 2003	M1/2"- H1/2"	20 cm	1	10	2,91	✓
0820 2004	M3/8"- H3/8"	20 cm	1	10	2,44	✓
0820 2501	M1/2"-H3/8"	25 cm	1	10	2,81	✓
0820 2502	M3/8"- H1/2"	25 cm	1	10	2,66	✓
0820 2503	M1/2"- H1/2"	25 cm	1	10	3,07	✓
0820 2504	M3/8"- H3/8"	25 cm	1	10	2,60	✓
0820 3001	M1/2"-H3/8"	30 cm	1	10	2,96	✓
0820 3002	M3/8"- H1/2"	30 cm	1	10	2,91	✓
0820 3003	M1/2"- H1/2"	30 cm	1	10	3,22	✓
0820 3004	M3/8"- H3/8"	30 cm	1	10	2,76	✓
0820 4001	M1/2"-H3/8"	40 cm	1	10	3,38	✓
0820 4002	M3/8"- H1/2"	40 cm	1	10	3,22	✓
0820 4003	M1/2"- H1/2"	40 cm	1	10	3,48	✓
0820 4004	M3/8"- H3/8"	40 cm	1	10	3,07	✓

CONEXIÓN FLEXIBLE INOX / CONNEXION FLEXIBLE INOX / ST. STEEL FLEXIBLE CONNECTION  
CONNESSIONE FLESSIBILE IN INOX / CONEXÃO FLEXÍVEL INOX



Ref						
0820 2006	H3/8"- H3/8"	20 cm	1	10	2,43	✓
0820 2007	H1/2"- H3/8"	20 cm	1	10	2,59	✓
0820 2005	H1/2"- H1/2"	20 cm	1	10	2,76	✓
0820 2506	H3/8"- H3/8"	25 cm	1	10	2,59	✓
0820 2507	H1/2"- H3/8"	25 cm	1	10	2,86	✓
0820 2505	H1/2"- H1/2"	25 cm	1	10	2,91	✓
0820 3006	H3/8"- H3/8"	30 cm	1	10	2,86	✓
0820 3007	H1/2"- H3/8"	30 cm	1	10	3,07	✓
0820 3005	H1/2"- H1/2"	30 cm	1	10	3,17	✓
0820 4006	H3/8"- H3/8"	40 cm	1	10	3,17	✓
0820 4007	H1/2"- H3/8"	40 cm	1	10	3,28	✓
0820 4005	H1/2"- H1/2"	40 cm	1	10	3,43	✓

CONEXIÓN FLEXIBLE INOX MACHO - HEMBRA / CONNEXION FLEX. INOX MALE - FEMELLE / ST. STEEL FLEX. CONNECTION MALE - FEMALE  
CONNESSIONE FLESSIBILE IN INOX MASCHIO - FEMMINA / CONEXÃO FLEXÍVEL INOX MACHO - FÊMEA



Ref						
0820 3508	M10x1 - H3/8"	35 cm	1	10	2,76	✓
0820 3509	M10x1 - H1/2"	35 cm	1	10	2,91	✓

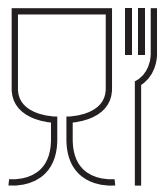

**RACORES INSTANTÁNEOS EN LATÓN CON TRATAMIENTO T.E.A.® - USO ALIMENTARIO**

**BRASS PUSH-IN FITTINGS WITH T.E.A.® SURFACE TREATMENT**



**US FOOD AND DRUG ADMINISTRATION**

TEA® es una aleación de acabado ecológico patentado según la norma NSF 61  
TEA® is a patented eco-friendly alloy finishing according to standard NSF 61

RECOMENDADOS PARA EL CONEXIONADO DE NUESTRO TUBO DE PTFE  
RECOMMENDED FOR OUR PTFE TUBE CONNECTION

RECTO MACHO CILÍNDRICO TEA ALIMENTARIO / RACCORD DROIT MÂLE CYLINDRIQUE TEA / STRAIGHT MALE FITTING T.E.A.  
RACCORDO MASCHIO DRITTO CILINDRICO T.E.A. / RETO MACHO CILÍNDRICO TEA



Ref				
0530 0405	T-4	M-5	1	6,19
0530 0418	T-4	R-1/8"	1	5,04
0530 0414	T-4	R-1/4"	1	6,43
0530 0618	T-6	R-1/8"	1	5,34
0530 0614	T-6	R-1/4"	1	6,09
0530 0818	T-8	R-1/8"	1	6,05
0530 0814	T-8	R-1/4"	1	6,60
0530 0838	T-8	R-3/8"	1	9,44
0530 1014	T-10	R-1/4"	1	10,97
0530 1038	T-10	R-3/8"	1	11,93
0530 1214	T-12	R-1/4"	1	13,51
0530 1238	T-12	R-3/8"	1	12,95
0530 1212	T-12	R-1/2"	1	16,61

RECTO HEMBRA CILÍNDRICO TEA ALIMENTARIO / RACCORD DROIT FEMELLE TEA / STRAIGHT FEMALE FITTING T.E.A.  
RACCORDO FEMMINA T.E.A. / RETO FÊMEATEA



Ref				
0531 0418	T-4	R-1/8"	1	7,47
0531 0414	T-4	R-1/4"	1	9,52
0531 0618	T-6	R-1/8"	1	7,66
0531 0614	T-6	R-1/4"	1	9,44
0531 0818	T-8	R-1/8"	1	9,85
0531 0814	T-8	R-1/4"	1	10,11

UNIÓN RECTA PASAMUROS TUBO-TUBO TEA ALIMENTARIO / RACCORD DROIT PASSE CLOISON TUBE - TUBE TEA  
BULKHEAD UNION TUBE-TUBE STRAIGHT ADAPTER (NICKEL-PLATED BRASS) T.E.A. / RACCORDO DRITTO DI COLLEGAMENTO TUBO-TUBO T.E.A.  
UNIÃO RETA PASSA-MUROS TUBO-TUBO TEA



Ref		$\varnothing$		
0532 0004	T-4	11 mm	1	7,51
0532 0006	T-6	11 mm	1	8,42
0532 0008	T-8	17 mm	1	11,74

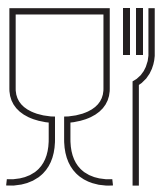

**RACORES INSTANTÁNEOS EN LATÓN CON  
TRATAMIENTO T.E.A.® - USO ALIMENTARIO**

**BRASS PUSH-IN FITTINGS WITH T.E.A.®  
SURFACE TREATMENT**



**US FOOD AND DRUG ADMINISTRATION**

TEA® es una aleación de acabado ecológico patentado según la norma NSF 61

TEA® is a patented eco-friendly alloy finishing according to standard NSF 61

RECOMENDADOS PARA EL CONEXIONADO DE NUESTRO TUBO DE PTFE  
RECOMMENDED FOR OUR PTFE TUBE CONNECTION

CODO MACHO CILÍNDRICO GIRATORIO TEA ALIMENTARIO / RACCORD COUDE MALE CYLINDRIQUE ROTATIF TEA / SWIVEL MALE ELBOW T.E.A.  
GOMITO MASCHIO CILINDRICO GIREVOLE T.E.A. / COTOVELO MACHO CILÍNDRICO GIRATÓRIO TEA



Ref				
0533 0405	T-4	M-5	1	7,92
0533 0418	T-4	R-1/8"	1	7,82
0533 0618	T-6	R-1/8"	1	7,66
0533 0614	T-6	R-1/4"	1	9,44
0533 0818	T-8	R-1/8"	1	9,35
0533 0814	T-8	R-1/4"	1	10,36
0533 0838	T-8	R-3/8"	1	14,99
0533 1014	T-10	R-1/4"	1	15,50
0533 1038	T-10	R-3/8"	1	17,52
0533 1214	T-12	R-1/4"	1	19,55
0533 1238	T-12	R-3/8"	1	19,60
0533 1212	T-12	R-1/2"	1	25,90

UNIÓN RECTA TUBO-TUBO TEA ALIMENTARIO / RACCORD DROIT PASSE CLOISON TUBE - TUBE TEA / STRAIGHT UNION TUBE-TUBE T.E.A.  
RACCORDO DRITTO TUBO-TUBO T.E.A. / UNIÃO RETA TUBO-TUBO TEA



Ref			
0534 0004	T-4	1	7,37
0534 0006	T-6	1	7,72
0534 0008	T-8	1	8,84
0534 0010	T-10	1	14,27
0534 0012	T-12	1	17,16

UNIÓN EN CODO TUBO-TUBO TEA ALIMENTARIO / RACCORD EN COUDE TUBE - TUBE TEA / UNION ELBOW TUBE-TUBE T.E.A.  
RACCORDO CODOLO TUBO-TUBO T.E.A. / UNIÃO EM COTOVELO TUBO-TUBO TEA



Ref			
0535 0004	T-4	1	7,24
0535 0006	T-6	1	7,82
0535 0008	T-8	1	8,68
0535 0010	T-10	1	14,99
0535 0012	T-12	1	18,28

UNIÓN EN "T" TUBO-TUBO TEA ALIMENTARIO / RACCORD EN "T" TUBE - TUBE - TUBE TEA / UNION TEE TUBE-TUBE-TUBE T.E.A.  
RACCORDO A "T" TUBO-TUBO-TUBO T.E.A. / UNIÃO EM "T" TUBO-TUBO-TUBO TEA



Ref			
0536 0004	T-4	1	10,06
0536 0006	T-6	1	10,46
0536 0008	T-8	1	11,94
0536 0010	T-10	1	20,62
0536 0012	T-12	1	24,71





TUBERÍAS DE POLIAMIDA PA12 PARA VEHÍCULO INDUSTRIAL / TUBE POLYAMIDE PA12 POUR VEHICULES INDUSTRIELS  
POLYAMIDE PA12 TUBES FOR COMMERCIAL VEHICLES / TUBI IN POLIAMMIDE PA12 PER VEICOLI INDUSTRIALE / TUBOS POLIAMIDA PA12

**DIN 74324 (P.A.12)**



ES Conducciones de sistema de freno neumático en vehículos a motor.  
FR Conduits des systèmes de frein pneumatique dans les véhicules à moteur.  
EN Pneumatic braking system conductions in motor vehicles.  
IT Tubazioni impianto freno pneumatico per veicoli a motore.  
PT Condições do sistema de frenagem pneumática em veículos a motor.

**Precio / metro**

**Price / meter**

Ref					x m
<b>0650 0204</b>	2 x 4	44 - bar	200		<b>0,85</b>
<b>0650 0406</b>	4 x 6	27 - bar	100		<b>1,21</b>
<b>0650 0608</b>	6 x 8	19 - bar	100		<b>1,60</b>
<b>0650 0609</b>	6 x 9	33 - bar	100		<b>2,71</b>
<b>0650 7510</b>	7,5 x 10	19 - bar	100		<b>2,85</b>
<b>0650 0810</b>	8 x 10	15 - bar	100		<b>2,06</b>
<b>0650 0912</b>	9 x 12	19 - bar	50		<b>3,50</b>
<b>0650 1014</b>	10 x 14	22 - bar	50		<b>5,38</b>
<b>0650 1216</b>	12 x 16	19 - bar	50		<b>6,20</b>
<b>0650 1418</b>	14 x 18	15 - bar	50		<b>8,25</b>

**DIN 73378 (P.A.12)**



ES Conducciones de combustible e instalaciones neumáticas.  
FR Conduits de carburants et installations pneumatiques.  
EN Fuel conductions and pneumatic systems.  
IT Tubazioni per combustibile e impianti pneumatici.  
PT Condições de combustível e sistemas pneumáticos.

Ref	Ref				
-	<b>0651 1503N</b>	1,5 x 3	-	200	<b>0,72</b>
-	<b>0651 0204N</b>	2 x 4	44 bar	200	<b>0,78</b>
<b>0651 2704</b>	<b>0651 2704N</b>	2,7 x 4	26 bar	200	<b>0,66</b>
<b>0651 0305</b>	<b>0651 0305N</b>	3 x 5	34 bar	100	<b>1,02</b>
<b>0651 0306</b>	-	3 x 6	44 bar	100	<b>2,07</b>
-	<b>0651 0406N</b>	4 x 6	27 bar	100	<b>1,15</b>
<b>0651 0508</b>	-	5 x 8	31 bar	100	<b>2,21</b>
-	<b>0651 0608N</b>	6 x 8	19 bar	100	<b>1,55</b>
-	<b>0651 0810N</b>	8 x 10	15 bar	100	<b>1,97</b>
<b>0651 0812</b>	-	8 x 12	27 bar	50	<b>5,36</b>
-	<b>0651 0912N</b>	9 x 12	19 bar	50	<b>3,48</b>
<b>0651 1012</b>	<b>0651 1012N</b>	10 x 12	12 bar	50	<b>2,43</b>
<b>0651 1114</b>	<b>0651 1114N</b>	11 x 14	16 bar	50	<b>5,23</b>
<b>0651 1214</b>	-	12 x 14	10 bar	50	<b>3,25</b>
<b>0651 1215</b>	<b>0651 1215N</b>	12 x 15	15 bar	50	<b>4,58</b>
<b>0651 1316</b>	<b>0651 1316N</b>	13 x 16	14 bar	50	<b>6,20</b>

**DIN 73378 (P.A.12)**

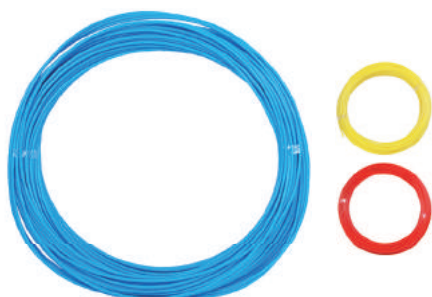

Ref	Ref	Ref			
<b>0651 0406A</b>	<b>0651 0406R</b>	<b>0651 0406B</b>	4 x 6	100	<b>1,40</b>
<b>0651 0608A</b>	<b>0651 0608R</b>	<b>0651 0608B</b>	6 x 8	100	<b>1,81</b>
-	<b>0651 0810R</b>	<b>0651 0810B</b>	8 x 10	100	<b>2,30</b>
-	-	<b>0651 0912B</b>	9 x 12	50	<b>4,05</b>
-	<b>0651 1012R</b>	-	10 x 12	50	<b>2,65</b>
-	-	<b>0651 1012B</b>	10 x 12	50	<b>2,80</b>
-	-	<b>0651 1215B</b>	12 x 15	50	<b>4,82</b>



TUBERÍAS DE POLIURETANO (TPU) / POLIURETANO FLEXIBLES / POLYURETHANE TUBES / TUBI POLIURETANO / TUBOS POLIURETANO



ES Conducciones de aire, poliuretano de base poliéster de dureza 98 SHORE A.  
FR Circulation d'air, polyuréthane à base de polyester de dureté 98 SHORE A.  
EN Air tubes, made from polyurethane with the base of polyester, hardness 98 SHORE A.  
IT Conduzione dell'aria, poliuretano a base di poliester, durezza 98 SHORE A.  
PT Tubos de ar, feitos a partir de poliuretano com base de poliéster de dureza 98 SHORE A.

Cajas de 25 m / Boites de 25 m / Box of 25 m / Pacchi da 25 m / Caixas de 25 m

Ref			x box
<b>0653 2504</b>	2,5 x 4	1	<b>19,20</b>
<b>0653 0305</b>	3 x 5	1	<b>27,90</b>
<b>0653 0406</b>	4 x 6	1	<b>27,55</b>
<b>0653 5508</b>	5,5 x 8	1	<b>39,50</b>
<b>0653 0608</b>	6 x 8	1	<b>33,75</b>
<b>0653 0710</b>	7 x 10	1	<b>68,11</b>
<b>0653 0810</b>	8 x 10	1	<b>49,50</b>
<b>0653 0812</b>	8 x 12	1	<b>99,67</b>
<b>0653 0912</b>	9 x 12	1	<b>74,95</b>

TUBO (PTFE) / TUBE (PTFE) / TUBES (PTFE) / TUBO (PTFE) / TUBO (PTFE)



ES Rápida conducción de líquidos, gran resistencia química, soporta altas temperaturas: 260°C.  
FR Circulation rapide du liquide, grande résistance chimique, supporte de hautes températures: 260°C.  
EN Tube for quick transportation of liquids, high chemical resistance, resistant to high temperatures: 260°C.  
IT Conduzione rapida dei liquidi, grande resistenza chimica, resistente ad alte temperature: 260°C.  
PT Tubo para o transporte rápido de líquidos, alta resistência química, resistentes a altas temperaturas: 260°C.

Cajas de 25 m / Boites de 25 m / Box of 25 m / Pacchi da 25 m / Caixas de 25 m

Ref			x box
<b>0652 0204</b>	2 x 4	1	<b>105,40</b>
<b>0652 0406</b>	4 x 6	1	<b>138,90</b>
<b>0652 0608</b>	6 x 8	1	<b>205,80</b>
<b>0652 0810</b>	8 x 10	1	<b>259,65</b>
<b>0652 1012</b>	10 x 12	1	<b>299,90</b>

CORTA TUBO DE PLÁSTICO / COUPE TUBES / PLASTIC TUBE CUTTER / TAGLIATUBI / CORTADOR DE TUBO DE PLÁSTICO



Ref		
<b>0650 9999</b>	1	<b>9,78</b>



	ES	FR	EN	IT	PT
<b>Ref</b>	Referencia	Référence	Reference	Riferimento	Referência
<b>HP</b>	Caballos de fuerza	Puissance (Chevaux)	Horse Power	Forza Pistola	Cavalos de potência
<b>rpm</b>	RPM = Revoluciones Por Minuto	RPM = Rotations Par Minute	RPM = Revolutions Per Minute	RPM = Giri Per Minuto	RPM = Rotações por minuto
	Caudal aire	Débit d'air	Volume of flow	Volume d'aria	Fluxo de ar
	Presión	Pression	Pressure	Pressione	Pressão
	Presión rotura. Máxima presión	Pression max.	Max pressure. Breaking pressure	Pressione massima	Max. Pressão. Pressão ruptura
	Depósito	Capacité	Capacity	Capacità	Depósito
	Peso	Poids	Weight	Peso	Peso
	Medidas	Mesures	Measurements	Misure	Medidas
	Precio	Prix	Price	Prezzo	Preço
	Cuadrado bocas	Entrées	Socket entrance	Ingresso becco	Encaixes quadrados
	Rosca entrada aire PT	Filetage entrée air	Thread - air entrance	Filetto - ingresso aria	Rosca entrada de ar PT
	Consumo aire	Commatation air	Air consumption	Consumo d'aria	Consumo de ar
	Fuerza apriete	Force serrage	Tightening power	Forza d'apertura	Força de aperto
	Diámetro manguera	Diamètre fl exible	Hose diameter	Diametro manico	Diâmetro da mangueira
	Golpes	Coups	Hits	Forza dell' impatto	Golpes
<b>M</b>	Métrica	Métrique	Metrical	Metrica	Métrica
	Descripción	Description	Description	Descrizione	Descrição
	Broca	Foret	Drill	Punta	Broca
	Sistema	Système	System	Sistema	Sistema
	Diámetro de aguja	Diamètre de l'aiguille	Needle diameter	Diâmetro da agulha	Diametro punta
	Diámetro	Diamètre	Diameter	Diametro	Diâmetro
	Oscilaciones por minuto	Oscillations par minute	Oscillation per minute	Oscillazioni per minuto	Oscilações por minuto
	Corte	Coupe	Cut	Taglio	Corte
	Material	Matériel	Material	Materiale	Material
	Número de dientes	Nombre de dents	Teeth number	Numero denti	Número de dentes
	Unidad mínima de venta	Nombre d'unités minimum de vente	Minimum sale unit	Quantitativo minimo di vendita	Unidade mínima de venda
	Longitud	Longueur	Length	Lunghezza	Comprimento
	Blíster	Blister	Blister	Blister	Blister
	Rosca	Filetage	Thread	Rivettatura	Rosca entrada de ar PT
	Medida exterior tubo	Dimension tube extérieur	Outside tube measure	Misure tubo esterno	Medida exterior tubo
	Tubo	Tube	Tube	Tubo	Tubo
	Packing	Conditionnement	Packing	Imballo	Embalagem
	Hembra	Femelle	Female	Femmina	Fêmea
	Macho	Male	Male	Maschio	Macho
	Modelo racorería	Modèle raccords	Model of fitting	Modello raccordi	Modelo de conexões
	Contenido	Contenu	Contains	Contenuto	Inclui
<b>MODEL</b>	Modelo	Modèle	Model	Modello	Modelo
	Espiga	Épi	Brad	Spiga	Conector
	Color	Couleur	Color	Colore	Cores







●.cofan

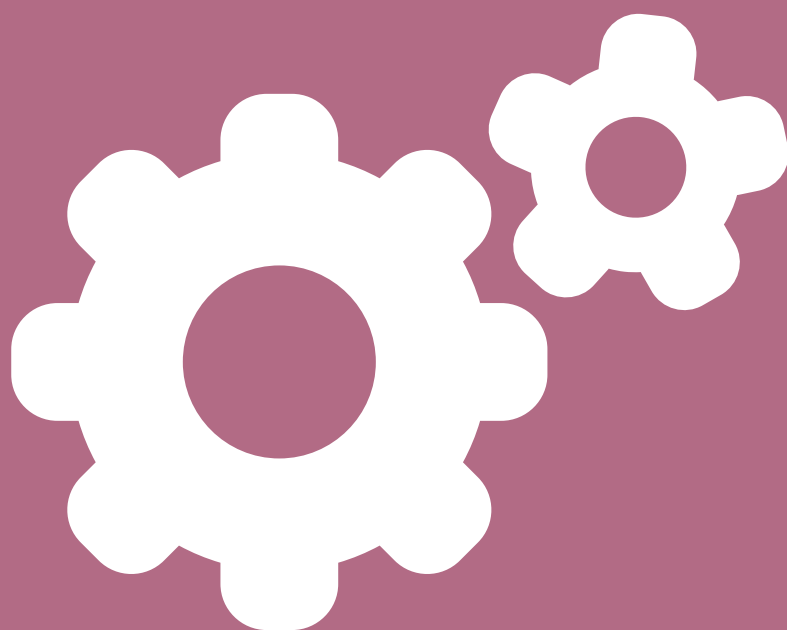



# ÍNDICE / INDEX / CONTENTS

## INDICE / ÍNDICE



### 302

BOMBAS / POMPE / GUNS  
POMPE / BOMBAS



### 313

BOMBAS DE TRASVASE / POMPES DE TRANSVASEMENT  
TRANSFER PUMP / POMPA TRAVASO  
BOMBAS DE TRANSFERÊNCIA



### 307

BOQUILLAS DE ENGRASE / BOUCHE GRAISSEURS  
COUPLERS GREASE GUN / BOCCA DI INGRASSAGGIO  
PONTEIRAS DE LUBRIFICAR



### 316

PRODUCTOS QUÍMICOS / PRODUITS CHIMIQUES  
CHEMICALS / PRODOTTI CHIMICI / QUÍMICOS



### 308

ENGRASADORES / GRAISSEURS / GREASERS  
INGRASSATORI / LUBRIFICADORES



### 320

ESCOBILLAS LIMPIAPARABRISAS / BALAIS ESSUIE-GLACE  
WINDSHIELD WIPER / SPAZZOLE TERGICRISTALLI  
ESCOVAS LIMPIA PARA-BRISAS



### 310

EMBUDOS / ENTONNOIRS / FUNNELS  
IMBUTI / FUNIS



### 321

MUELLE NEUMÁTICO UNIVERSAL  
VÉRIN DE HAYON UNIVERSEL  
UNIVERSAL GAS SPRING AMMORTIZATORE  
PNEUMATICO UNIVERSALE  
MOLA PNEUMÁTICA UNIVERSAL



### 312

ACCESORIOS ENGRASE / ACCESSOIRES DE GRAISSAGE  
LUBRICATION ACCESSORIES  
ACCESSORI PER LA LUBRIFICAZIONE  
ACCESSÓRIOS DE LUBRIFICAÇÃO



### 322

PINZAS ARRANQUE / COLLIERS DE DEMARRAGE  
JUMP LEADS / CAVI DI AVVIAMENTO  
PINZAS ARRANQUE



**323**

FAROS DE TRABAJO LED / LAMPE DE TRAVAIL  
LED WORK LAMP / FARO DA LAVORO / FOCO TRABALHO

---



**324**

LÁMPARAS AUTOMOCIÓN / AMPOULE / BULB  
LAMPADINA / LÂMPADA

---

**i**

**328**

GLOSARIO / GLASSAIRE / GLOSSARY  
GLOSSARIO / GLOSSÁRIO



BOMBA DE GRASA PORTÁTIL 5 Kg / POMPE A GRAISSE PORTABLE 5 Kg / OIL PUMP PORTABLE 5 Kg  
POMPA PER GRASSO PORTATILE 5 Kg / BOMBA LUBRIFICANTE PORTÁTIL 5 Kg

Presión max  
Pression max  
Max. Pressure  
Pressione massima  
Pressão máxima:  
690 BAR  
10.000 PSI



ES Bomba con capacidad para 5 kg de grasa fabricada en aluminio con cubeta muy ligera en material plástico de gran resistencia a los golpes. Sistema de engrase manual accionado por el pie mediante un émbolo. Útil para usar en puntos de engrase bloqueados. Equipada con manguera de alta presión con 1,5 metros, pistola de acero giratoria con extensión y boquilla de engrase incluidas. Válida para vehículos de construcción, agricultura y automotor.

FR Pompe à graisse portable capacité 5kg de graisse; fabriquée en aluminium avec récipient léger en plastique, résistant aux coups. Système de lubrification manuelle actionné par le pied au moyen d'un piston. Utile pour utiliser sur des points de lubrification bloqués. Équipée d'un flexible de haute pression d'1.5 mètres, pistolet rotatif en acier avec possibilité d'extension et bouche de graissage inclus. Adapte pour les véhicules de construction, agricoles, industriels et motorisés.

EN 5kg Oil pump portable to use with based aluminium grease with a very ligh plastic bucket with a big shock resistance. It gets accivate manually by pushing the foot plunger. Very useful for blockage or hard ends. It contains a 1,5 meter high pressure hose, rotating steel gun with extensions and grease nipple. Suitable for construction, agriculture and automotive vehicles.

IT Pompa per grasso portatile da 5Kg, fabbricata in alluminio con serbatoio molto leggero in materiale plastico molto resistente agli urti. Sistema di ingrassaggio manuale azionato con il piede tramite un pistone. Utile per l'utilizzo in punti di ingrassaggio bloccati. Dotato di tubo ad alta pressione da 1,5 metri, con pistola in acciaio con estensione e bocchetta di ingrassaggio inclusa. Adatto per veicoli da cantiere, agricoli e autoveicoli.

PT Bomba Lubrificante portátil para 5kg de lubrificante, feita de alumínio, com recipiente muito leve de material plástico altamente resistente a choques. Sistema de lubrificação manual operado pelo pé através de um êmbolo. Útil para uso em pontos de lubrificação bloqueados. Equipado com mangueira de alta pressão com 1,5 metros, com pistola de rotação em aço e extensão e bico de lubrificação incluídos. Válida para veículos de construação, agricultura e auto motor.

Ref				
3100 1007	5 Kg	1,5 m	1	399,80



Granel  
Vrac  
Bulk load  
Travaso  
Granel

Ref: 1550 2028

Recambios / spare parts

Kit bomba de grasa portátil / Kit bombe de graisse portatif / Oil pump portable kit  
Kit pompa ingrassaggio portatile / Kit bomba de lubrificante portátil

Ref		
3100 1007.01	1	116,13

ENGRASADORA ELÉCTRICA / GRAISSEUSE ÉLECTRIQUE / ELECTRIC GREASE GUN / INGRASSATRICE ELETTRICA / BOMBA DE MASSA ELÉCTRICA

19,2 V



1,5 Ah Ni-Cd  
(Baterly packs)



ES Engrasadora con dos baterías de 19,2V y cargador rápido "una hora". Con presión de 413 BAR. Provisita de manguera de alta presión (760 mm), con muelle protector en ambos extremos y boquilla de 4 garras incluidas. Capacidad para 400 gramos de grasa en cartuchos o a granel. Válida para vehículos de construcción, agricultura, industriales y automotor.

FR Graisseur avec deux batterie 19,2V et chargeur rapide "une heure". Pression de 413 bars Fourni avec un tuyau de haute pression (760 mm), avec un ressort de protection aux deux extrémités et une bouche de 4 griffes incluse. Capacité de 400g rammes de graisse en cartouches ou en vrac. Adapte pour les véhicules de construction, agricoles et motorisés.

EN Battery powered grease gun 19,2V and "one hour" charge. 413 BAR pressure. It includes a high pressure hose (760 mm), with spring guard both ends and a 4 mouthpiece nozzle. Suitable for construction, agriculture, industrial and automotive vehicles.

IT Ingrassatore con due batterie da 19,2V e caricabatteria rapido "un'ora". Con pressione da 413 Bar. Provvisto di tubo ad alta pressione (760 mm), con molla di protezione ad entrambi gli estremi e bocchetta a 4 ganasce incluso. Capacità per 400g di grasso in cartuccia o sciolto. valida per veicoli da cantiere, agricoli, industriali e autoveicoli.

PT Lubrificador com duas baterias 19,2V e carregador rápido "uma hora". Com pressão de 413 BAR. Equipado com mangueira de alta pressão (760 mm), com mola de proteção em ambas as extremidades e bocal de 4-mandíbulas incluído. Até 400 gramas de lubrificante em cartuchos ou a granel. Válida para veículos de construção, agricultura, industriais e auto motor.

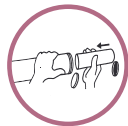

Cartucho  
Cartouche  
Cartridge  
Cartuccia  
Cartucho

Ref: 1550 2029



Succión  
Aspiration  
Suction  
Aspirazione  
Sucção



Granel  
Vrac  
Bulk load  
Travaso  
Granel

Ref: 1550 2028



Presión max  
Pression max  
Max. Pressure  
Pressione massima  
Pressão máxima:  
413 BAR  
6.000 PSI

Ref				
3100 1006	400 g	413 bar	1	522,35

Ref		
3100 1006.01	1	91,00

PURGADOR





BOMBA ENGRASE MANUAL P/CARTUCHO / POMPE A GRAISSE MANUELLE A CARTOUCHE / MANUAL GREASE GUN FOR CARTRIDGE  
 POMPA INGRASSAGGIO MANUALE PER CARTUCCIA / BOMBA DE LUBRIFICAÇÃO MANUAL DE CARTUCHO

400 g



ROSCA GRANDE  
 GRAND FORMAT FILETAGE  
 LARGE THREAD  
 FILETTATURA GRANDE  
 ROSCA GRANDE

**ADAPTABLE SISTEMA LUBE-SHUTTLE / ADAPTABLE LUBE-SHUTTLE SYSTEM**

ES Pistola de engrase manual para el uso de alta presión rápida y sin esfuerzo. Ideal para el uso con cartuchos de grasa en 400 gr. con rosca grande. **Este sistema de cartuchos permite el cambio rápido de varios tipos de grasa y no produce burbujas de aire, por lo cual no es necesario ser purgada.** Presión de salida 10.000PSI/369BAR y 0,5g por impulso. Equipada con boquilla de 4 garras.

FR Pistolet de lubrification manuel pour une utilisation à haute pression rapide et sans effort. Idéal pour une utilisation avec des cartouches de graisse de 400gr. avec grand filetage. Ce système de cartouches permet un changement rapide de plusieurs types de graisse et **ne produit pas de bulles d'air, aucune purge n'est donc nécessaire.** Pression de sortie 10000psi/369BAR et 0,5g par impulsion. Équipe d'une ouverture à 4 griffes.

EN Manual grease gun for speed high-pressure uses and without any effort. Suitable for 400gr. grease cartridges with large thread. This cartridge system allows a quick change into several types of grease and **it does not produce air bubbles, so there is no need to bleed the air out.** Output pressure 10000psi/369BAR and 0.5g per stroke. Equipped with a nozzle consisting of a 4-jaw coupler.

IT Pistola ingrassatrice manuale per l'utilizzo ad alta pressione e senza sforzo. Ideale per l'utilizzo di cartucce da 400gr. con filettatura grande. Il sistema a cartuccia consente il cambio rapido di varie tipologie di grasso e **non produce bolle d'aria, che non devono essere eliminate.** Pressione di uscita 10000psi/369BAR per impulso. Equipaggiata con ugello a 4 griffe.

PT Pistola de lubrificação manual para o uso de alta pressão rápida e sem esforço. Ideal para usar com cartuchos de lubrificante em 400gr. com rosca grande. Este sistema de cartuchos permite a troca rápida de vários tipos de lubrificante e **não produz bolhas de ar, por isso não é necessário purgar.** Pressão de saída 10000psi/369B e 0,5g por impulso. Equipado com bocal de 4 garras.

**ADAPTABLE LUBE-SHUTTLE**

Ref			
3100 1008	1	20	32,86

BOMBA ENGRASE DOBLE ALTA PRESIÓN PROFESIONAL / POMPE A GRAISSE DOUBLE HAUTE PRESSION PROFESSIONNELLE  
 DOUBLE GREASE GUN HIGH PRESSURE PROFESSIONAL / POMPA INGRASSAGGIO DOPPIA, ALTA PRESSIONE, PROFESSIONALE  
 BOMBA DE LUBRIFICAÇÃO DUPLA ALTA PRESSÃO PROFISSIONALCARTUCHO

400 - 500 - 600 g



Rosca pequeña  
 Petit filetage  
 Small thread  
 Filettatura piccola  
 Rosca pequena

**ADAPTABLE SISTEMA FUCHS / ADAPTABLE FUCHS SYSTEM**

ES Pistola de engrase con dos palancas, diseñado para el uso de alta presión rápida y sin esfuerzo. Ideal para el uso con cartuchos de grasa de hasta 600 gr. con rosca pequeña. Este sistema de cartuchos permite el cambio rápido de varios tipos de grasa y **no produce burbujas de aire, por lo cual no es necesario ser purgada.** Presión de salida 7500psi/517BAR y 0,8 g de impulso. Equipada con 300 mm de tubo flexible y boquilla de 4 garras.

FR Pistolet de lubrification avec deux leviers, conçu pour une utilisation à haute pression rapide et sans effort. Idéal pour l'utilisation avec des cartouches de graisse jusqu'à 600gr. avec un petit filetage. Ce système de cartouches permet le changement rapide de plusieurs types de graisse et **ne produit pas de bulles d'air, aucune purge n'est donc nécessaire.** Pression de sortie 7500psi/517BAR et de 0,8g d'impulsion. Équipée 300mm tube flexible et ouverture de 4 griffes.

EN Two-lever grease gun designed for speed high-pressure and without any effort. Suitable for 600gr. cartridges with small thread. This cartridge system allows a quick change into several types of grease and **it does not produce air bubbles, so there is no need to bleed the air out.** Output pressure 7500psi/517BAR and 0.8g per stroke. Equipped with a 300mm flexible tube and a nozzle consisting of a 4-jaw coupler.

IT Pistola ingrassatrice a due leve, progettata per l'utilizzo ad alta pressione e senza sforzo. Ideale per l'utilizzo di cartucce da 600gr. con filettatura piccola. Il sistema a cartuccia consente il cambio rapido di varie tipologie di grasso e **non produce bolle d'aria, che non devono essere eliminate.** Pressione di uscita 7500psi/517BAR e 0,8g per impulso. Dotata di 300mm di tubo flessibile e ugello a 4 griffe.

PT Pistola de lubrificação com duas alavancas para o uso de alta pressão rápida e sem esforço. Ideal para usar com cartuchos de lubrificante de até 600gr. com rosca pequena. Este sistema de cartuchos permite a troca rápida de vários tipos de lubrificante e **não produz bolhas de ar, por isso não é necessário purgar.** Pressão de saída 7500 psi/51BAR e 0,8g por impulso. Equipado com 300mm de tubo flexível e bocal de 4 garras.

**ADAPTABLE FUCHS**

Ref			
3100 1023	1	10	53,35



ADAPTADOR CARTUCHO GRASA ROSCA PEQUEÑA A ROSCA GRANDE  
 ADAPTATEUR CARTOUCHE DE GRAISSE PETIT A GRAND FILETAGE  
 GREASE CARTRIDGE ADAPTER FOR SMALL AND LARGE THREADS  
 ADATTATORE PER CARTUCCE DI GRASSO DA FILETTATURA PICCOLA A GRANDE  
 ADAPTADOR CARTUCHO LUBRIFICANTE ROSCA PEQUEÑA PARA ROSCA GRANDE

Ref		
3100 1028	1	9,10



BOMBA ENGRASE VERTICAL P/CARTUCHO / POMPE A GRAISSE VERTICALE A CARTOUCHE / VERTICAL GREASE GUN FOR CARTRIDGE  
POMPA INGRASSAGGIO VERTICALE PER CARTUCCIA / BOMBA DE LUBRIFICAÇÃO VERTICAL DE CARTUCHO

400 g

ADAPTABLE SISTEMA LUBE-SHUTTLE / ADAPTABLE LUBE-SHUTTLE SYSTEM



Rosca grande  
Grand format filetage  
Large thread  
Filettatura grande  
Rosca grande

ES Pistola de engrase vertical diseñada para el uso de alta presión rápida y sin esfuerzo. Ideal para el uso con cartuchos de grasa en 400 gr. con rosca grande. Este sistema de cartuchos permite el cambio rápido de varios tipos de grasa y **no produce burbujas de aire, por lo cual no es necesario ser purgada.** Presión de salida 5000 psi/345BAR y 0,5g por impulso. Equipada con boquilla de 4 garras.

FR Pistolet de lubrification vertical conçu pour l'utilisation à haute pression rapide et sans effort. Idéal pour une utilisation avec des cartouches de graisse de 400gr. avec grand filetage. Ce système de cartouches permet le changement rapide de plusieurs types de graisse et **ne produit pas de bulles d'air, aucune purge n'est donc nécessaire.** Pression de sortie 5000 psi/345BAR et 0,5g par impulsion. Équipée d'une ouverture à 4 griffes.

EN Vertical grease gun designed for speed high-pressure uses and without any effort. Suitable for 400gr. grease cartridges with large thread. This cartridge system allows a quick change into several types of grease and **it does not produce air bubbles, so there is no need to bleed the air out.** Output pressure 5000psi/345BAR and 0.5g per stroke. Equipped with a nozzle consisting of a 4-jaw coupler.

IT Pistola ingrassatrice verticale progettata per l'utilizzo ad alta pressione e senza sforzo. Ideale per l'utilizzo di cartucce da 400gr. con filettatura grande. Il sistema a cartuccia consente il cambio rapido di varie tipologie di grasso e **non produce bolle d'aria, che non devono essere eliminate.** Pressione di uscita 5000psi/345BAR e 0,5g per impulso. Equipaggiata con ugello a 4 griffe.

PT Pistola de lubrificação vertical para o uso de alta pressão rápida e sem esforço. Ideal para usar com cartuchos de lubrificante em 400gr. com rosca grande. Este sistema de cartuchos permite a troca rápida de vários tipos de lubrificante e **não produz bolhas de ar, por isso não é necessário purgar.** Pressão de saída 5000 psi/345BAR e 0,5g por impulso. Equipado com bocal de 4 garras.

Ref			
3100 1009	1	20	32,86

BOMBA DE ENGRASE A PALANCA PROFESIONAL / POMPE A GRAISSE PROFESSIONNELLE / GREASE GUNS HEAVY DUTY PROLUBE  
POMPA DI INGRASSAGGIO A LEVA PROFESSIONALE /



Toma de succión  
Prise d'aspiration  
Inlet suction  
Presà aspirazione  
Sucção de entrada

Purgador  
Purgeur  
Air purger  
Spurgo  
Purgador de ar

HEAVY DUTY

ES Carga a granel, por aspiración y con cartucho. Sistema antideslizante, con purgador. Empuñadura de PVC ergonómica. Pared aluminio reforzado 1,2 mm.

FR Charge vrac, par aspiration et avec cartouche. Systeme antidérapage avec purgeur. Poignée PVC ergonomique. Aluminium renforce 1,2 mm.

EN Bulk load, air intake and cartridge. Non-slipping, purge system. PVC ergonomic handle. Reinforced aluminium 1,2 mm.

IT Carico per travaso, per aspirazione e con cartuccia. Sistema antiscivolo, con spurgo, dispositivo idoneo per piccole applicazioni. Parete in alluminio rinforzato 1,2 mm.

PT Carga a granel, por aspiração e com cartucho. Não escorrega, sistema de purga. Pega ergonómica PVC. De alumínio reforçado com 1,2 mm.



Cartucho  
Cartouche  
Cartridge  
Cartuccia  
Cartucho

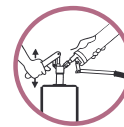

Granel  
Vrac  
Bulk load  
Travaso  
Granel



Succión  
Aspiration  
Suction  
Aspirazione  
Sucção



Presión max  
Pression max  
Max. Pressure  
Pressione massima  
Pressão máxima :  
413 BAR  
6.000 PSI

Ref			
3100 1002	400g/500 cm <sup>3</sup>	1	6 34,25



BOMBA DE ENGRASE A PALANCA ESTÁNDAR / POMPE A GRAISSE STANDARD / STANDARD GREASE GUN  
 POMPA DI INGRASSAGGIO A LEVA STANDARD / BOMBA DE LUBRIFICAÇÃO COM ALAVANCA STANDARD



Cartucho  
 Cartouche  
 Cartridge  
 Cartuccia  
 Cartucho



Granel  
 Vrac  
 Bulk load  
 Travaso  
 Granel



Succión  
 Aspiration  
 Suction  
 Aspirazione  
 Sucção



Presión max  
 Pression max  
 Max. Pressure  
 Pressione massima  
 Pressão máxima :  
 413 BAR  
 6.000 PSI

Ref				
<b>3100 1001</b>	400g/500 cm <sup>3</sup>	1	6	<b>22,25</b>

PISTOLA DE ENGRASE UNA MANO / POMPE À GRAISSE UNE MAIN / PISTOL GREASE GUN  
 PISTOLA DI INGRASSAGGIO AD UNA MANO / BOMBA DE LUBRIFICAÇÃO MONOCOMANDO



**ACCESOS DIFÍCILES / HARD-TO-REACH AREAS**

ES Carga a granel y con cartucho. Sistema antideslizante, con purgador. Pared aluminio reforzado 1,2 mm. Adecuada para accesos difíciles.

FR Charge vrac et avec cartouche. Systeme antiderapage avec purgeur. Systeme adapte pour petites applications. Aluminium renforcé 1,2 mm. Idéal pour traitement avec difficulté d'accès.

EN Bulk load and cartridge. Non-slipping purge system. Reinforced aluminium 1,2 mm. Suitable for difficult access places.

IT Carico per travaso e con cartuccia sistema antiscivolo, con spurgo, dispositivo idoneo per piccole applicazioni. Parete in alluminio rinforzato 1,2 mm.

PT Carga a granel, por aspiração e com cartucho. Não escorrega, sistema de purga. Alumínio reforçado 1,2 mm. Indicado para difícil acesso.



Cartucho  
 Cartouche  
 Cartridge  
 Cartuccia  
 Cartucho



Granel  
 Vrac  
 Bulk load  
 Travaso  
 Granel



Succión  
 Aspiration  
 Suction  
 Aspirazione  
 Sucção



Presión max  
 Pression max  
 Max. Pressure  
 Pressione massima  
 Pressão máxima :  
 413 BAR  
 6.000 PSI

Ref				
<b>3100 1003</b>	400g/500 cm <sup>3</sup>	1	6	<b>34,25</b>



BOMBA DE ENGRASE NEUMÁTICA / POMPE À GRAISSE PNEUMATIQUE / GREASE GUN NEUMATIC  
POMPA INGRASSAGGIO PNEUMATICA / BOMBA DE LUBRIFICAÇÃO PNEUMÁTICA



DIRECTAMENTE COMPRESOR

- ES Carga a granel y cartucho. Sistema antideslizante, con purgador. Adecuada para mínimas aplicaciones. Pared aluminio reforzado 1,2 mm. Es posible usarla directamente en el compresor del V.I. Acciones automáticas intermitentes.
- FR Charge vrac et avec cartouche. Système anti dérapage avec purgeur. Systeme adapte pour petites applications. Aluminium renforcé 1,2 mm. Possibilité d'utilisation directe sur compresseur du V.I.
- EN Bulk load and cartridge. Non-slipping, purge system. Suitable for inaccessible locations. Reinforced aluminium 1,2 mm It can be used directly on the industrial vehicle compressor. Intermittent self-actions.
- IT Carico per travaso e con cartuccia sistema antiscivolo, con spurgo, dispositivo idoneo per piccole applicazioni. Parete in alluminio rinforzato 1,2 mm E' possibile l'uso diretto dal compressore del veicolo industriale. Azioni automatiche intermittenti.
- PT Carga a granel e com cartucho. Não escorrega, sistema de purga. Indicado para locais inacessíveis. De alumínio reforçados com 1,2 mm. Pode ser usado directamente no compressor veiculo industrial. Ações automáticas intermitentes.



Cartucho  
Cartouche  
Cartridge  
Cartuccia  
Cartucho

Ref: 1550 2029



Succión  
Aspiration  
Suction  
Aspirazione  
Sucção



Granel  
Vrac  
Bulk load  
Travaso  
Granel

Ref: 1550 2028



Presión max  
Pression max  
Max. Pressure  
Pressione massima  
Pressão máxima :  
413 BAR  
6.000 PSI

Ref				
3100 1004	400g/500 cm <sup>3</sup>		1	123,00

INYECTOR DE VALVULINA / PISTOLET D'ASPIRATION / SUCTION GUN / INIETTORE DI LUBRIFICANTE / INJETOR DE VALVULINA

Manguera de vinilo 300 mm / 12".  
Flexible vinyle 300 mm / 12".  
Vinyl hose 300 mm / 12".  
Manico in vinile 300 mm / 12".  
Mangueira de vinil 300 mm / 12".



- ES Adecuado para uso con líquidos no corrosivos. Con manguera flexible de 300 mm en vinilo. Cabeza en aluminio fundido a presión.
- FR Utilisation avec des liquides non corrosifs. Avec tuyau flexible de 300 mm en vinyle. Tête en aluminium fondu à pression.
- EN Suitable for use with non corrosive liquids. Complete with 300 mm flexible vinyl hose. Aluminium die cast head.
- IT Adatto per uso con liquidi non corrosivi. Con manico flessibile di 300 mm in vinile. Testa in alluminio pressofuso.
- PT Adequado para utilização com líquidos não corrosivos. Com mangueira de vinil flexível de 300 milímetros. Cabeça em alumínio fundido.

Ref			
3100 1019	500 ml	1	19,24

MINI BOMBA DE GRASA 85 GRAMOS CON PULSADOR / MINI POMPE À GRAISSE AVEC BOUTON POUSSOIR / MINI GREASE GUN WITH PUSH BUTTON  
MINI INGRASSATORE CON PULSANTE / MINI BOMBA DE OLEO 85 GRAMOS COM BOTAO



1 0,028" (0,7 mm)  
2 0,039" (1,0 mm)  
3 0,055" (1,4 mm)

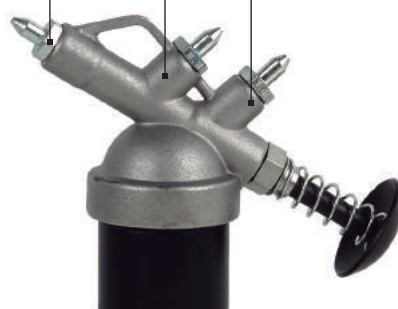

Ref			
3100 1038	85 g	1	29,48



BOQUILLAS DE ENGRASE / BOUCHE GRAISSEURS / COUPLERS GREASE GUN / BOCCA DI INGRASSAGGIO / PONTEIRAS DE LUBRIFICAR

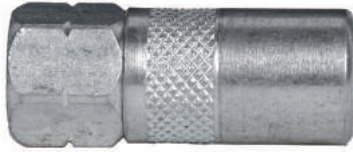

4 Garras 413 bar.  
4 Griffes 413 bars.  
4 Faces 413 bar.  
4 Ganasce 413 bar.  
4 Garras 413 bar.

Ref					
3100 1010	1/8 GAS	1	12	3,22	✓

LATIGUILLOS DE ENGRASE FLEXIBLES / GRAISSEURS FLEXIBLES / FLEXIBLE GREASE HOSES  
TUBO DI INGRASSAGGIO FLESSIBILI / TUBO DE LUBRIFICAÇÃO FLEXÍVEL



Presión de rotura / Pression de rupture  
Break pressure / Pressione di rottura  
Pressão de ruptura:  
1.700 BAR  
Rosca / Filetagee / Thread / Filettatura / Rosca:  
1/8 GAS

Ref						
3100 1011	1/8 GAS	225 mm	1	12	5,93	✓
3100 1012	1/8 GAS	300 mm	1	12	7,64	✓

PROLONGADOR RÍGIDO CURVO / EXTENSION RIGIDE COURBEE / RIGID STEEL EXTENSION  
TUBO DI INGRASSAGGIO RIGIDO CURVO / EXTENSÃO RÍGIDA E CURVA



Ref						
3100 1013	1/8 GAS	150 mm	1	12	1,98	✓

BOQUILLA ENGRASE ALTA PRESIÓN CONEXIÓN RÁPIDA / DÉCONNEXION RAPIDE DU RACCORD / QUICK DIS-CONNECT GREASE COUPLER  
RAPIDA DISCONNESSIONE / RÁPIDA DESCONEXÃO DO ACOPLADOR

1/8"  
BSPT



8,000 PSI  
(550 BAR)



ES Engrase de manos libres y sin fugas. 6 garras cilíndricas endurecidas. Garras de acero de muelle endurecido - mordazas abren y cierran con el movimiento de la palanca. Ideal para engrases de alta presión. Protege los engrasadores de rotura. Se adaptan a todo tipo de cabezas de las engrasadoras con rosca 1/8" BSPT. Para equipos engrasadores manuales, aire y de batería.

FR Graissage en mains libres et sans fuite. 6 griffes cylindriques renforcées. Griffes en acier ressort résistant -les mâchoires s'ouvrent et se ferment grâce au mouvement du levier. Idéal pour lubrifications de haute pression. Il protège les graisseurs de la casse. Ils s'adaptent à tout type de têtes de graisseurs avec filetage 1/8" BSPT. Pour des outils graisseurs manuels, pneumatiques et à batterie.

EN Hands free & leak proof greasing. 6 cylindrical jaws made of hardened steel. Spring actuated hardened spring steel jaws - jaws open & close by operating the lever. Conveniently dis-engages from grease fitting under pressure. Protects grease fitting from breakage. Fits all types of grease fitting head profiles of 1/8" BSPT. For hand, air & battery operated grease equipment.

IT Ingrassaggio a mani libere e senza perdite. 6 ganasce cilindriche temprate. Ganasce in acciaio temprato - il beccuccio si apre e chiude tramite il movimento della leva. Ideale per ingrassaggio ad alta pressione. Protegge gli ingrassatori dalla rottura. Si adattano a tutti i tipi di ingrassatori con testina filettata da 1/8" BSPT. Per ingrassatori manuali, ad aria e a batteria.

PT Lubrificação mãos livres e à prova de fugas. 6 garras cilíndricas em aço endurecido. Garras de aço para mola endurecida - garras que abrem e fecham c/ o movimento da alavanca. Ideal para lubrificações de alta pressão. Protege os lubrificadores de ruptura. Adaptam-se a todo o tipo de cabeças dos lubrificadores com rosca 1/8" BSPT. Para equipamentos de lubrificação manuais, ar e de bateria.

Ref			
3100 1024	1	10	35,26





ENGRASADOR RECTO / GRAISSEUR / GREASER STRAIGHT / INGRASSATORE DRITTO / LUBRIFICADOR RETO



Ref	🌀	📦	📊
3150 6100	6/100	100	0,42
3150 7100	7/100	100	0,73
3150 8100	8/100	100	0,30
3150 8125	8/125	100	0,30
3151 0100	10/100	100	0,33
3151 0125	10/125	100	0,41
3151 0150	10/150	100	0,41
3151 2100	12/100	50	1,05
3151 2125	12/125	50	1,05
3151 2150	12/150	50	1,05
3151 2175	12/175	50	1,98

Ref	🌀	📦	📊
3150 0104W	1/4 Whitworth	100	0,79
3150 0516W	5/16 Whitworth	100	0,79
3150 0308W	3/8 Whitworth	100	0,79
3150 0104S	1/4 Sae	100	0,73
3150 0516S	5/16 Sae	100	0,73
3150 0308S	3/8 Sae	100	0,73
3150 0108G	1/8 Gas	100	0,74
3150 0104G	1/4 Gas	50	0,90

ENGRASADOR SEMICURVO 45° / GRAISSEUR SEMI CURVE / GREASER SEMI CURVED / INGRASSATORE SEMICURVO / LUBRIFICADOR SEMI CURVO



Ref	🌀	📦	📊
3160 6100	6/100	100	0,68
3160 7100	7/100	100	0,68
3160 8100	8/100	100	0,68
3160 8125	8/125	100	0,68
3161 0100	10/100	100	0,73
3161 0125	10/125	100	0,89
3161 0150	10/150	100	0,89
3161 2100	12/100	50	2,19
3161 2125	12/125	50	2,19
3161 2150	12/150	50	2,19
3161 2175	12/175	50	2,19

Ref	🌀	📦	📊
3160 0104W	1/4 Whitworth	100	1,11
3160 0516W	5/16 Whitworth	100	1,11
3160 0308W	3/8 Whitworth	100	1,11
3160 0104S	1/4 Sae	100	0,95
3160 0516S	5/16 Sae	100	0,95
3160 0308S	3/8 Sae	100	0,95
3160 0108G	1/8 Gas	100	0,95
3160 0104G	1/4 Gas	50	1,27

ENGRASADOR CURVO 90° / GRAISSEUR CURVED / GREASER CURVED / INGRASSATORE CURVO / LUBRIFICADOR CURVO



Ref	🌀	📦	📊
3170 6100	6/100	100	0,68
3170 7100	7/100	100	0,68
3170 8100	8/100	100	0,68
3170 8125	8/125	100	0,68
3171 0100	10/100	100	0,73
3171 0125	10/125	100	0,89
3171 0150	10/150	100	0,89
3171 2100	12/100	50	1,47
3171 2125	12/125	50	1,47
3171 2150	12/150	50	1,47
3171 2175	12/175	50	2,19

Ref	🌀	📦	📊
3170 0104W	1/4 Whitworth	100	1,11
3170 0516W	5/16 Whitworth	100	1,11
3170 0308W	3/8 Whitworth	100	1,11
3170 0104S	1/4 SAE	100	0,95
3170 0516S	5/16 SAE	100	0,95
3170 0308S	3/8 SAE	100	0,95
3170 0108G	1/8 GAS	100	0,95
3170 0104G	1/4 GAS	50	1,27



MALETÍN ENGRASADORES / MALETTE GRAISSEURS / SET GREASERS / VALIGETTA INGRASSATORI / CAIXA CON LUBRIFICADORES



Ref			
3150 0108G		1/8 GAS	50
3150 6100		6/100	75
3150 8100		8/100	40
3151 0100		10/100	50
3160 6100		6/100	20
3160 8100		8/100	20
3161 0100		10/100	25

Ref		
<b>3180 0001</b>	280 pcs	<b>142,68</b>

Ref			
3150 0104G		1/4 GAS	25
3150 0108G		1/8 GAS	40
3150 6100		6/100	100
3150 8100		8/100	50
3151 0100		10/100	40
3160 0104G		1/4 GAS	15
3160 0108G		1/8 GAS	25
3160 6100		6/100	25
3160 8100		8/100	25
3161 0100		10/100	25
3170 0104G		1/4 GAS	15
3170 0108G		1/8 GAS	25
3170 6100		6/100	25
3170 8100		8/100	25
3171 0100		10/100	25

Ref		
<b>3180 0002</b>	485 pcs	<b>236,27</b>

EMBUDOS / ENTONNOIRS / FUNNELS / IMBUTI / FUNIS

ALIMENTADOR DE GRASA POLICARBONATO / ALIMENTATION GRAISSE DE POLYCARBONATE / POLYCARBONATE GREASE FEEDER  
LUBRIFICATORE AUTOMATICO IN POLICARBONATO / ALIMENTADOR DE LUBRIFICANTE POLICARBONATO



CONTENIDO

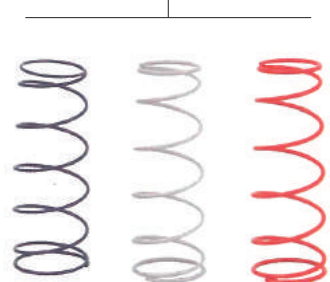

- BAJO  
BAS  
LOW  
BASSA  
BAIXO
- MEDIO  
MOYEN  
MEDIUM  
MEDIA  
MÉDIO
- ALTO  
HAUT  
HIGH  
ALTA  
ALTO

ES Alimentadores de grasa con rosca 1/8" Gas, fabricados en policarbonato para proporcionar la lubricación controlada en punto único. Regula la descarga de grasa en proporción a los cambios de presión del resorte, manteniendo así constante la presión de descarga de 1 - 2 PSI. Posibilidad de cambio de resorte incluidos (Bajo-color azul, Medio-color plata, Alto-color rojo). Los resortes o muelles pueden ser fácilmente intercambiados dependiendo de la densidad de la grasa utilizada, es posible montarlos en cualquier posición y facilitan la inspección visual de los niveles de grasa reutilizables.

FR Dispositif d'alimentation de graisse avec spirale 1/8 "Gaz, fabriqué en polycarbonate pour approvisionnement de graisse contrôlé en un point unique. Régle la décharge de graisse en proportion aux changements de pression du ressort, en maintenant la pression de décharge de 1 -2 PSI constante. Possibilité de changement de ressort inclus (faible- Couleur bleue, Moyen- Couleur argent, Fort- Couleur rouge). Les ressorts peuvent facilement être changés en fonction de la densité de la graisse utilisée, il est possible de les monter dans toute position et permettent de visualiser les niveaux de graisse réutilisables.

EN Grease feeders with thread 1/8" gas, manufactured in polycarbonate to provide a controlled lubrication in just one point. It adjusts the grease output according to the pressure changes of the spring, keeping constantly the output pressure of 1-2 PSI. Possibility to change the spring included (Low-blue colour, Medium-silver colour, High-red colour). The springs can be easily interchanged depending on the grease density used. It is possible to assembly them in any position, making easier the visual inspection of the grease levels that are reusable.

IT Lubrificatore con filettatura 1/8" a gas, fabbricato in policarbonato per una regolazione controllata per singolo punto. Regola la fuoriuscita del grasso in funzione della variazione di pressione della molla, mantenendo così costante la pressione di scarico di 1-2PSI. Possibilità di cambiare la molla inclusa. (Bassa - blu; Media - argento; Alta - rossa). Le molle possono essere facilmente cambiate in funzione della densità del grasso utilizzato, è possibile montarle in qualsiasi posizione e facilitano l'ispezione visiva dei livelli di grasso riutilizzabili.

PT Alimentadores de lubrificante com rosca 1/8 "Gás, feita de policarbonato para proporcionar a lubrificação controlada em um único ponto. Regula a descarga de lubrificante em proporção às mudanças da pressão da mola, mantendo assim constante a pressão de descarga de 1 -2 PSI. Possibilidade de troca de mola incluído (Baixo-cor azul, Médio-prata, Alto-vermelho). As molas podem ser facilmente trocadas, dependendo da densidade do lubrificante utilizado, pode montar em qualquer posição e facilitam a inspeção visual dos níveis de lubrificante reutilizáveis.

Ref				
<b>3100 1035</b>	28 g	1	36	<b>35,10</b>
<b>3100 1036</b>	56 g	1	36	<b>36,92</b>
<b>3100 1037</b>	170 g	1	36	<b>63,75</b>



ACEITERA PROFESIONAL / BURETTE D'HUILE / INDUSTRIAL OILCAN / OLIERA PROFESSIONALE / ALMOTOLIA PROFISSIONAL



Ref				
3100 1014	200 ml	1	6	6,50
3100 1015	500 ml	1	6	8,27

RECOGEDOR ACEITE USADO / RECIPIENT POUR HUILE USAGEE / OIL USED CONTAINER  
VASCA RECUPERO OLIO ESAUSTO / COLETOR DE ÓLEO USADO



ES Recogedor de aceite usado con 16 litros de capacidad y boquilla con tapón ideal para recoger tanto aceites usados, combustibles, anticongelantes como cualquier otro producto contaminante de una manera limpia y cómoda. Fabricado en material plástico de alta resistencia.

FR Récipient huile usagée de 16 litres et bec avec bouchon idéal pour récupérer des huiles usagées, du carburant, de l'antigel et autre produit proprement et facilement. Fabriqué en plastique résistant.

EN Oil used container, capacity 16 litres and nozzle with a cap ideal to collect used oil, antifreezers or any other hazardous substance in a clean and easy way. Made of a high resistance plastic.

IT Vasca di recupero di olio esausto da 16 litri di capacità e con bocchetta provvista di tappo ideale per il recupero di olio esausto, combustibili, anticongelanti come qualsiasi altro prodotto contaminato, il tutto in maniera pulita e semplice. Fabbricato in materiale plastico ad alta resistenza.

PT Coletor de óleo usado com capacidade de 16 litros e bico com tampa ideal para a coleta tanto de óleos usados, combustível, anti-congelante e qualquer outro produto contaminante, de uma maneira limpa e cómoda. Feito de material plástico de alta resistência.

Ref			
3100 1022	16 L	1	26,78

EMBUDO CON FILTRO PARA COMBUSTIBLE / ENTONNOIR AVEC FILTRE A CARBURANT / FUNNEL WITH FILTER FOR FUEL  
IMBUTO TRAVASATORE CON FILTRO / FUNIL COM FILTRO PARA COMBUSTÍVEL



Separa suciedad y agua.  
Il sépare la saleté et l'eau.  
It separates the dirt from water.  
Separa sporco e acqua.  
Separa a sujidade da água.

Vierta el combustible sucio.  
Versez le carburant sale.  
Pour dirty fuel in.  
Versa il combustibile sporco.  
Despeje o combustível sujo.

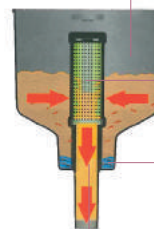

El filtro retiene agua, suciedad y restos.  
Le filtre retient l'eau, la saleté et les résidus.  
Filter traps water, dirt and debris.  
Il filtro trattiene acqua, sporco e detriti.  
O filtro retém água, sujeira e detritos.

Depósito.  
Réservoir.  
Deposit.  
Deposito.  
Depósito.

El combustible sale limpio.  
Le carburant ressort propre.  
Pure fuel comes out.  
Il combustibile esce pulito.  
O combustível sai limpo.

Ref			
3100 1031	1	25	68,54



EMBUDO CÓNICO POLIETILENO / ENTONNOIR CONIQUE POLYÉTHYLÈNE / CONIC POLYETHYLENE FUNNEL  
 IMBUTO CONICO IN POLIETILENE / FUNIL DE CONE POLIETILENO

650 ml



Ref				
3100 1032	650 ml	1	40	2,34

1800 ml



Ref				
3100 1033	1800 ml	1	60	4,73

4,7 L



Ref				
3100 1034	4,7 L	1	30	11,34

EMBUDO ANTI-SALPICADURAS / ENTONNOIR ANTI-ÉCLABOUSSURES / ANTI-SPLASHING FUNNEL / IMBUTO ANTI-SPRUZZO / FUNIL ANTI-SALPICOS



Flexible.  
Flexible.  
Flexible.  
Flessibile.  
Flexível.



2"

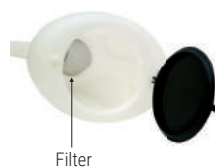

Filter

Ref		$\varnothing$			
3100 1017	Polipropileno	8"-205 mm	1,7 L	1	10,92
3100 1018	Polipropileno	9-½" - 240 mm	3 L	1	13,36



GRIFO POLIETILENO CONTAINER R - 3/4" / ROBINET POLYÉTHYLÈNE RESERVOIR R - 3/4 " / POLYETHYLENE TAP CONTAINER R - 3/4"  
 RUBINETTO POLIETILENE PER FUSTI R - 3/4" / SAÍDA POLIETILENO RECIPIENTE R - 3/4"



Ref				
3100 1025	3/4"	1	500	5,82

GRIFO POLIETILENO CONTAINER R - 2" / ROBINET POLYÉTHYLÈNE RESERVOIR R - 2 " / POLYETHYLENE TAP CONTAINER R - 2"  
 RUBINETTO POLIETILENE PER FUSTI R - 2" / SAÍDA POLIETILENO RECIPIENTE R - 2"



Ref				
3100 1026	2"	1	50	20,70

INDICADOR DE NIVEL PARA GRIFO 2" / INDICATEUR DE NIVEAU POUR ROBINET 2 " / LEVEL INDICATOR FOR TAP 2"  
 INDICATORE DI LIVELLO PER RUBINETTO 2" / INDICADOR DE NIVEL PARA SAÍDA 2"



Grifo no incluído  
 Robinet non inclus  
 Tap non included  
 Rubinetto non incluso  
 Saída não incluída



Ref			
3100 1027	1	20	20,70

INDICADOR NIVEL PARA DEPÓSITOS ROSCA 3/4" / INDICATEUR DE NIVEAU POUR LES RÉSERVOIRS FILETAGE 3/4" / DRUM LEVEL INDICATOR THREAD 3/4"  
 INDICATORE DEL LIVELLO DEL TAMBURÒ FILETTATURA 3/4" / INDICADOR NIVEL PARA DEPÓSITOS R. 3/4"



Ref			
3100 1029	3/4"	1	56,16





BOMBA ROTATIVA PARA OIL Y FUEL / POMPE ROTATIVE POUR HUILE ET CARBURANT / ROTATORY BOMB FOR OIL AND FUEL  
POMPA ROTATIVA PER OLIO E COMBUSTIBILE / BOMBA ROTATIVA PARA ÓLEO E COMBUSTÍVEL



**HEAVY DUTY**  
**50 / 205 litros**

ES Uso recomendado para productos con base petróleo y diésel fuel. No usar con disolventes, productos con base en agua, alcalino y ácidos. Válidos para bidones de 50-205 litros. Viscosidad máxima: 2000 SSU. Caudal: 38 LPM (10 GPM) @120 RPM.

FR Utilisation recommandée pour produits carburant. Ne pas utiliser avec des solvants, produits à base d'eau, alcalines et acides. Valables pour bidons de 50-205 litres. Viscosité maximum: 2000 SSU. Débit: 38 LPM (10GPM) @ 120 RPM.

EN Recommended use for petroleum based media and diesel fuels. Do not use with water based media, solvents, acids and alkalines. Fits 15-55 gallon (50-205 litres) drums. Maximum viscosity: 2000 SSU. Flow: 38 LPM (10 GPM) @ 120 RPM.

IT Uso raccomandato per prodotti a base d'olio e gasolio. Non utilizzare con solventi, prodotti a base d'acqua, alcalini ed acidi. Valido per fusti da 50-205 litri. Viscosità massima: 2000 SSU. Portata: 38 LPM (10 GPM) @ 120 RPM.

PT Recomendado para produtos à base de petróleo e combustíveis diesel. Não use com produtos com base em água, dissolventes, ácidos e alcalinos. Para recipientes de 50-205 litros. Viscosidade máxima: 2000 SSU. Fluxo: 38 LPM (10 GPM) @ 120 RPM.



Colgador.  
Poignée.  
Nozzle holder.  
Portaugello.  
Suporte do bocal.

Aluminio-Antichispa.  
Bec alluminium.  
Non sparking aluminium.  
Alluminio, anti- scintilla.  
Alumínio anti-faíscas.

Manguera antiestática para fuel.  
Flexible antistatique pour carburant.  
Anti-static fuel hose.  
Tube antistatico per carburante.  
Mangueira de combustivel anti-estática.

Telescópico.  
Téléscopique.  
Telescopic.  
Telescopico.  
Telescópico.



ES Para su uso con líquidos inflamables y combustibles como la gasolina, nafta, alcoholes y otros disolventes de clase I y clase II.

FR Pour une utilisation avec des liquides inflammables et des carburants comme l'essence, naphte, alcools et autres solvants de classe I et classe II.

EN For use with class I and class II flammable and combustible liquids such as gasoline, naphtha, alcohols and other solvents.

IT Per l'uso con liquidi infiammabili e combustibili come benzina, nafta, alcol e altri solventi di classi I e II.

PT Para uso com líquidos inflamáveis e combustíveis, como gasolina, nafta, álcoois e outros solventes de classe I e classe II.

Ref		
3100 1016	1	275,00

BOMBA DE TRASVASE A PALANCA / VIDE FUT A LEVIER / LEVER ACTION BARREL PUMP  
POMPA DI TRAVASO A LEVA / BOMBA TRANSFERÊNCIA ALAVANCA



**50 / 205 litros**

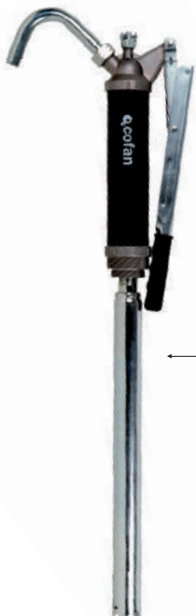

ES Para petróleo, gasóleo y aceite industrial, salida rígida de la bomba, 380 cm3 por impulso, válido para bidones de 50 y 205 litros.

FR Pour petrole, essence, et huile industrielle, sortie rigide de la pompe, 380 cm3 par impulsions, s'adapte aux bidons de 50 et 205 litres.

EN Oil, diesel oil and industrial oil, rigid spread, 380 cm3 per impulse, available for drums of 50 to 205 litres.

IT Per petrolio, gasolio e olio industriale, uscita rigida dalla pompa, 380 cm3 per impulso, adatto per fusti da 50 e 205 litri.

PT Para petróleo, diesel e óleo industrial, saída rígida da bomba, de 380 cm3 por impulso, para recipientes de 50 e 205 litros.

Telescópico.  
Téléscopique.  
Telescopic.  
Telescopico.  
Telescópico.

Ref			
3100 1005	50 L - 205 L	1	41,00



**BOMBA ELÉCTRICA + PISTOLA BIDÓN / POMPE ÉLECTRIQUE + PISTOLET BOÎTE / ELECTRIC DRUM PUMP  
POMPA ELETTRICA + LANCIA SERBATOIO / BOMBA ELÉTRICA + PISTOLA BIDAÓ**



**CONEXIÓN BATERÍA 12V  
HASTA / UPTO 18,4 LPM**

ES Cable de 12V DC. Cuerpo de plástico compacto y ligero. Tubo telescópico para bidones tanto de 205 litros como contenedores IBC de 1000 a 1250 litros. Tapón incorporado de 2" y un tapón convertidor adicional de 2,5" para usar con bombas de plástico y con contenedores IBC. Ciclo de trabajo: 15 minutos encendido / 15 minutos apagado. Incluye cable de 12V DC, manguera de suministro de 2 m, dispensador manual de 19 mm con boquerel de acero inoxidable y alojamiento para pistola.

FR Câble de 12V DC. Corps en plastique compact et léger. Tube télescopique pour bidons de 205 litres (55 gallons) ou pour containers IBC de 1000 à 1250 litres (277-330 gallons). Bouchon intégré de 2" et bouchon convertisseur additionnel de 2.5" pour utiliser avec pompes en plastique et containers IBC. Cycle de travail: 15 minutes en marche / 15 minutes éteint. Inclut un câble de 12V DC, tuyau d'approvisionnement de 2 m, dispensateur manuel 19 mm avec embout en acier inoxydable et support pour le pistolet.

EN 12V DC power cable. Compact & Lightweight Plastic Body. Telescopic Pump tube for use with (205 Litre) drums as well as. (1000 to 1250 Litre) IBC's. Built-in 2" Bung & an additional Bung Converter (2.5" x 5 Buttress) for use with Plastic Drums & IBC's. Duty Cycle: 15 minutes On / 15 minutes O. Includes 12V DC power cable, 2 m delivery hose, 19 mm manual dispensing nozzle with stainless steel spout and nozzle holder.

IT Cavo da 12V DC. Corpo di plastica, compatto e leggero. Tubo telescopico per bidoni sia da 205 litri, sia contenitori IBC da 1000 a 1250 litri. Tappo incorporato da 2" e un tappo addizionale da 2,5" da utilizzare con pompe di plastica e contenitori IBC. Ciclo di lavoro: 15 minuti acceso / 15 minuti spento. Include cavo da 12V DC, tubo di alimentazione da 2 m, erogatore manuale 19 mm con ugello in acciaio inossidabile e alloggiamento per pistola.

PT Cabo de 12V DC. Corpo de plástico compacto e leve. Tubo telescópico para Bidões de 205 litros e contentores IBC de 1000 a 1250 litros. Tampão incorporado de 2" e um tampão conversor adicional de 2,5" para usar com bombas de plástico e com IBCs. Ciclo de trabalho: 15 minutos ligado / 15 minutos desligado. Inclui cabo de 12V DC, mangueira de alimentação de 2 m, dispensador manual de 19 mm com bocal de aço inoxidável e caixa para pistola.

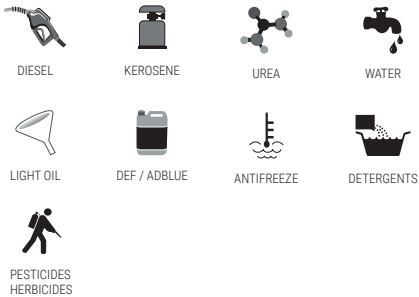

Ref	⚡	📦	📦
<b>3100 1101</b>	12 V	1	<b>358,02</b>



**CONEXIÓN RED 220V / AC  
UPTO 18,9 LPM**

ES 110V-240V AC, 50/60 Hz. Cuerpo de plástico compacto y ligero. Tubo telescópico para bidones tanto de 205 litros como contenedores IBC de 1000 a 1250 litros. Tapón incorporado de 2" y un tapón convertidor adicional de 2,5" para usar con bombas de plástico y con contenedores IBC. Ciclo de trabajo: 15 minutos encendido / 15 minutos apagado. Incluye adaptador de corriente AC, manguera de suministro de 2 m, dispensador manual 19 mm boquerel de acero inoxidable y alojamiento para pistola.

FR 110V-240V AC, 50/60 Hz. Corps en plastique compact et léger. Tube télescopique pour bidons de 205 litres ou pour containers IBC de 1000 à 1250 litres. Bouchon intégré de 2" et bouchon convertisseur additionnel de 2.5" pour utiliser avec pompes en plastique et containers IBC. Cycle de travail: 15 minutes en marche / 15 minutes éteint. Inclut un adaptateur de courant AC, tuyau d'approvisionnement de 2 m, dispensateur manuel 19 mm embout en acier inoxydable et support pour pistolet.

EN 110V-240V AC, 50/60 Hz. Compact & Lightweight Plastic Body. Telescopic Pump tube for use. (205 Litre) drums as well as. (1000 to 1250 Litre) IBC's. Built-in 2" Bung & an additional Bung Converter (2.5" x 5 Buttress) for use with Plastic Drums & IBC's. Duty Cycle: 15 minutes On / 15 minutes O. Includes AC Power Adapter, 2 m Delivery Hose, Manual ¾" Dispensing Nozzle with SS Spout & Nozzle Holder.

IT 110V-240V AC, 50/60 Hz. Corpo di plastica, compatto e leggero. Tubo telescopico per bidoni sia da 205 litri, sia contenitori IBC da 1000 a 1250 litri. Tappo incorporato da 2" e un tappo addizionale da 2,5" da utilizzare con pompe di plastica e contenitori IBC. Ciclo di lavoro: 15 minuti acceso / 15 minuti spento. Include adattatore corrente AC, tubo di alimentazione da 2 m, erogatore manuale da 19 mm con ugello in acciaio inossidabile e alloggiamento per pistola.

PT 110V-240V AC, 50/60 Hz. Corpo de plástico compacto e leve. Tubo telescópico para Bidões de 205 litros e contentores IBC de 1000 a 1250 litros. Tampão incorporado de 2" e um tampão conversor adicional de 2,5" para usar com bombas de plástico e com IBCs. Ciclo de trabalho: 15 minutos ligado / 15 minutos desligado. Inclui adaptador de corrente AC, mangueira de alimentação de 2 m, dispensador manual de 19 mm com bocal de aço inoxidável e caixa para pistola.



Ref	⚡	📦	📦
<b>3100 1102</b>	12 V	1	<b>400,14</b>



BOMBA ELÉCTRICA + PISTOLA BIDÓN RECARGABLE / POMPE ÉLECTRIQUE + PISTOLET BOÎTE RECHARGEABLE  
ELECTRIC DRUM PUMP WITH RECHARGEABLE BATTERY / POMPA ELETTRICA + LANCIA SERBATOIO RICARICABILE  
BOMBA ELÉTRICA + PISTOLA BIDAÓ RECARGÁVEL



**UPTO 28 LPM**  
**UPTO 410 LITRE**  
**WITH SINGLE**  
**CONEXIÓN BATERÍA RECARGABLE / BATTERY CHARGE**

ES Cable de 12V DC. Cuerpo de plástico compacto y ligero. Tubo telescópico para bidones tanto de 205 litros como contenedores IBC de 1000 a 1250 litros. Tapón incorporado de 2" y un tapón convertidor adicional de 2,5" para usar con bombas de plástico y con contenedores IBC. Ciclo de trabajo: 15 minutos encendido / 15 minutos apagado. Incluye cable de 12V DC, manguera de suministro de 2 m (6,6'), dispensador manual de 19 mm (3/4") con boquerel de acero inoxidable y alojamiento para pistola.

FR Câble de 12V DC. Corps en plastique compact et léger. Tube télescopique pour bidons de 205 litres (55 gallons) ou pour containers IBC de 1000 à 1250 litres (277-330 gallons). Bouchon intégré de 2" et bouchon convertisseur additionnel de 2.5" pour utiliser avec pompes en plastique et containers IBC. Cycle de travail: 15 minutes en marche / 15 minutes éteint. Inclut un câble de 12V DC, tuyau d'approvisionnement de 2 m, dispensateur manuel 19 mm avec embout en acier inoxydable et support pour le pistolet.

EN 12V DC power cable. Compact & Lightweight Plastic Body. Telescopic Pump tube for use with (205 Litre) drums as well as. (1000 to 1250 Litre) IBC's. Built-in 2" Bung & an additional Bung Converter (2.5" x 5 Buttress) for use with Plastic Drums & IBC's. Duty Cycle: 15 minutes On / 15 minutes O. Includes 12V DC power cable, 2 m delivery hose, 19 mm manual dispensing nozzle with stainless steel spout and nozzle holder.

IT Cavo da 12V DC. Corpo di plastica, compatto e leggero. Tubo telescopico per bidoni sia da 205 litri, sia contenitori IBC da 1000 a 1250 litri. Tappo incorporato da 2" e un tappo addizionale da 2,5" da utilizzare con pompe di plastica e contenitori IBC. Ciclo di lavoro: 15 minuti acceso / 15 minuti spento. Include cavo da 12V DC, tubo di alimentazione da 2 m, erogatore manuale 19 mm con ugello in acciaio inossidabile e alloggiamento per pistola.

PT Cabo de 12V DC. Corpo de plástico compacto e leve. Tubo telescópico para Bidões de 205 litros e contentores IBC de 1000 a 1250 litros. Tampão incorporado de 2" e um tampão conversor adicional de 2,5" para usar com bombas de plástico e com IBCs. Ciclo de trabalho: 15 minutos ligado / 15 minutos desligado. Inclui cabo de 12V DC, mangueira de alimentação de 2 m, dispensador manual de 19 mm com bocal de aço inoxidável e caixa para pistola.



Ref	12 V		
3100 1103	Bateria recargable / Batterie rechargeable / Rechargeable battery Batteria ricaricabile / bateria recarregável	1	568,62

BOMBA PLÁSTICA DE PALANCA / POMPE PLASTIQUE A LEVIER / PLASTIC LEVER PUMP  
POMPA IN PLASTICA A LEVA / BOMBA PLÁSTICA DE ALAVANCA



**Barriles de 50 y 205 litros**  
**Drums 50 and 205 litres**

ES Bomba plástica de palanca para barriles de 50 y 205 litros con rosca de 2" y tuerca para una correcta fijación. Diseñada para su uso con aceites de alta viscosidad, productos químicos, detergentes, jabones, anticongelantes, limpiaparabrisas, aceites hidráulicos, lubricantes, herbicidas y plaguicidas, AdBlue, Urea, etc. Exclusivamente para utilizar con materiales no inflamables. Se suministra con tubo de succión extensible y manguera de descarga flexible con 2 metros de longitud.

FR Pompe à levier en plastique pour des barils de 50 ou de 205 litres avec filetage de 2" et vis permettant une fixation correcte. Conçue pour être utilisé avec des huiles présentant une haute viscosité, avec des produits chimiques, des détergents, des antigels, du produit à vitres, des huiles hydrauliques, des lubrifiants, herbicides et pesticides, de l'Adblue, Urée, etc.... pour utiliser exclusivement avec des matériaux non inflammables. Fournie avec un tube d'aspiration extensible et un tuyau de déchargement flexible de 2 mètres de long.

EN Plastic lever pump for drums 50 0 205 litres with a 2" thread and a nut fastening. Design for high viscosity grease, chemical products, soaps, antifreeze, windshield washer, lubricants, insecticides, fungicides, fertilizers&herbicides, Adblue, Urea, etc... Only to use with non inflammable liquids. Suction extensible tube & flexible hose for dispensing grease with 2 meters.

IT Pompa in plastica a leva, per barili da 50 o 205 litri con filettatura da 2" e dado per un corretto fissaggio. Progettata per l'utilizzo con oli ad alta viscosità, prodotti chimici, detergenti, saponi, anticongelanti, pulisci tergicristalli, oli idraulici, lubrificanti, erbicidi e pesticidi, Adblue, Urea, ecc.. Esclusivamente da utilizzare con materiali non infiammabili. Fornito con tubo di aspirazione estensibile e tubo di scarico flessibile lungo 2 metri.

PT Bomba de plástico com alavanca para tambores de 50 ou 205 litros com rosca 2" e porca para uma fixação adequada. Projetado para uso com óleos de alta viscosidade, produtos químicos, detergentes, sabões, anticongelantes, limpa-pára-brisas, óleos hidráulicos, lubrificantes, herbicidas e pesticidas, AdBlue, ureia, etc. ... exclusivamente para uso com materiais não inflamáveis. Fornecido com tubo de sucção e extensível e mangueira de descarga flexível com 2 metros de comprimento.

HASTA 500 ml/impulso

Ref	2"		
3100 1030		1	164,74



ANTICONGELANTE 50% ORGÁNICO / ANTIGEL 50% ORGANIQUE / ANTIFREEZE 50% ORGANIC  
ANTIGELO 50% ORGANICO / ANTICONGELANTE 50% ORGÁNICO

**G-12 / G-13**  
**-37°C ± 1°C**



ES Formulación orgánica. Protege el circuito de refrigeración del motor de la congelación, el recalentamiento y de corrosiones en aluminios, metales, plásticos... Degrada más lentamente alargando su vida.

FR Formule organique. Protège le circuit de refroidissement du moteur du gel, de la surchauffe et de la corrosion de l'aluminium, du métal, du plastique, etc. Dégradation plus lente, longue durée de vie.

EN Organic formulation. Protects the engine cooling circuit from freezing, overheating and corrosion in aluminium, metal and plastic parts. Slower corrosion, prolonging its service life.

IT Formulazione organica. Protegge il circuito di raffreddamento del motore dal congelamento, dal surriscaldamento e dalla corrosione di alluminio, metallo, plastica, ecc. Questa particolare formulazione si degrada più lentamente, allungando la sua durata.

PT Formulação orgânica. Protege o circuito de refrigeração do motor contra o congelamento, do superaquecimento e corrosão em alumínio, metais, plásticos, etc. Degrada-se mais lentamente, prolongando a sua validade.

Ref				
<b>1550 2011</b>	5 L	1	4	<b>16,40</b>
<b>1550 2021</b>	1 L	1	8	<b>4,51</b>

**G-12 / G-13**  
**-37°C ± 1°C**



Ref				
<b>1550 2014</b>	5 L	1	4	<b>16,40</b>
<b>1550 2022</b>	1 L	1	8	<b>4,51</b>

ANTICONGELANTE-REFRIGERANTE 30% / ANTIGEL-REFROIDISSEMENT 30% / ANTIFREEZE-COOLANT 30%  
ANTIGELO-REFRIGERANTE 30% / ANTICONGELANTE-REFRIGERANTE 30%

**-18°C ± 1°C**



ES Protege el circuito de refrigeración del motor de la congelación, el recalentamiento y de corrosiones en aluminios, metales, plásticos. etc.

FR Protège le circuit de refroidissement du moteur du gel, de la surchauffe et de la corrosion de l'aluminium, du métal, du plastique, etc.

EN Protects the engine cooling circuit from freezing, overheating and corrosion in aluminium, metal and plastic parts.

IT Protegge il circuito di raffreddamento del motore dal congelamento, dal surriscaldamento e dalla corrosione di alluminio, metallo, plastica, ecc.

PT Protege o circuito de refrigeração do motor contra o congelamento, do superaquecimento e corrosão em alumínio, metais, plásticos, etc.

Ref				
<b>1550 2012</b>	5 L	1	4	<b>12,45</b>
<b>1550 2015</b>	2 L	1	8	<b>7,42</b>

LAVAPARABRISAS / LAVE-GLACES / WINDSCREEN CLEANER / DETERGENTE PARABREZZA / LIMPA-PARA-BRISAS

**-10°C ± 1°C**



ES Desengrasa y limpia a fondo el parabrisas del coche. Evita la congelación en invierno y la humedad en las ventanas. Secado rápido.

FR Dégrasse et nettoie le pare-brise de voiture. Evite le gel en hiver et l'humidité sur les fenêtres. Séchage rapide.

EN It cleans and degreases your car windscreen thoroughly. Prevents from freezing in the winter and humidity in the windows. Quick drying

IT Questo detergente sgrassa e pulisce a fondo il parabrezza dell'autovetture. Evita il congelamento in inverno e l'umidità sulle finestre. Asciugatura rapida.

PT Desengordura e limpa completamente o pára-brisas do carro. Impede o congelamento no inverno e a humidade nas janelas. Secagem rápida.

Ref				
<b>1550 2013</b>	5 L	1	4	<b>5,99</b>
<b>1550 2023</b>	1 L	1	8	<b>2,05</b>



 ACEITE SEMI SINTETICO PLUS MOTOR 2 T / HUILE SEMI-SYNTHESE PLUS MOTEUR 2 T / SEMI SYNTHETIC OIL PLUS FOR 2-STROKE ENGINE  
 OLIO SEMISINTETICO PLUS MOTORE A 2 T / ÓLEO SEMI SINTÉTICO PLUS MOTOR 2 T

**JASO M345 FC; ISO-L-EGD;**
**API:TC;**
**TISI**
**Dosis de empleo:**
**Mezcla al 2% - 3%**
**2 TIEMPOS  
2-STROKE ENGINE**

Tipo de Análisis Type of Analysis	Método / Method	Resultado / Results
Viscosidad a 40°C Viscosity at 40°C	ASTM D - 455	60-65
Índice de Viscosidad Viscosity index.	ASTM D - 2270	125 cSt
Punto de Inflamación Flash point	ASTM D - 92	120 °C
Punto de congelación Freezing point	ASTM D - 97	-30 °C
Color / Colour		VERDE OSCURO

ES Lubricante de composición sintética para motores de 2 tiempos. Indicado para todo tipo de motores de 2 tiempos de motocicletas, cortacésped, motosierras...

FR Lubrifiant de composition synthétique pour moteurs 2 temps. Convient à tous les types de moteurs de 2 temps de motos, tondeuses à gazon, tronçonneuses ...

EN Lubricant of synthetic composition for 2-stroke engines. Suitable for any 2T engines as motorcycles, lawnmowers, chainsaws...

IT Lubrificante a composizione sintetica per motori a 2 tempi. Adatto a qualsiasi motore 2T come motocicli, falciatrici, motoseghe...

PT Lubrificante de composição sintética para motores de 2 tempos. Indicado para todo o tipo de motores de 2 tempos, motociclos, corta relvas, motosserras.

ES Bajo contenido en cenizas, lo que previene de la preignición, y mantiene los pistones y segmentos libres de depósitos. Baja viscosidad que permite lubricar rápidamente todas las piezas del motor y facilita el arranque. Gran resistencia a temperaturas elevadas. Alto poder detergente que mantiene el motor limpio de depósitos y barro. Reduce la formación de humos. Capacidad antigripado para alargar la vida de los ciclomotores. Perfectamente soluble en gasolina.

FR Faible teneur en cendres, ce qui empêche la pré-inflammation et maintient les pistons et les segments exempts de dépôts. Faible viscosité qui permet de lubrifier rapidement toutes les pièces du moteur et facilite le démarrage. Grande résistance aux températures élevées. Fort pouvoir détergent qui maintient le moteur propre des dépôts et de la boue. Réduit la formation de fumée. Capacité antigrippant pour allonger la durée de vie des cyclomoteurs. Parfaitement soluble dans l'essence.

EN Low ash content, which prevents pre-ignition and keeps the pistons and segments free of deposits. Low viscosity that allows to lubricate quickly all parts of the engine and facilitates the start. It has a great resistance to high temperatures. High detergent power that keeps the engine clean of deposits and mud. Reduces smoke formation. Antigrippability that allows to extend the life of mopeds. Perfectly soluble in gasoline.

IT Basso contenuto di ceneri, che impedisce la pre-accensione e mantiene i pistoni e segmenti liberi di depositi. Basso viscosità che consente di lubrificare rapidamente tutte le parti del motore e facilita l'avviamento. Grande resistenza alle alte temperature. Alta potenza detergente che mantiene il motore pulito da depositi e fango. Riduce la formazione di fumo. Antigrippabilità che consente di prolungare la vita dei ciclomotori. Perfettamente solubile in benzina.

PT Baixo teor de cinza, o que evita a pré-ignição e mantém os pistões e os segmentos livres de depósitos. Baixa viscosidade que permite lubrificar rapidamente todas as peças do motor e facilita o arranque. Grande resistência a temperaturas elevadas. Alto poder detergente que mantém o motor limpo de depósitos e lama. Reduz a formação de fumos. Capacidade anti-gripagem para alargar a vida dos ciclomotores. Perfeitamente solúvel em gasolina.

Ref				
<b>1550 2030</b>	1 L	1	18	<b>7,17</b>

 ACEITE SINTETICO MOTOR 10W-40 PLUS 4 T / HUILE SYNTHÈSE 10W-40 PLUS MOTEUR DE 4 T / SYNTHETIC OIL 10W-40 PLUS 4-STROKE ENGINE  
 OLIO SINTETICO MOTORE 10W-40 PLUS A 4 T / ÓLEO SINTÉTICO PARA MOTOR 10W-40 PLUS 4 T

**API SN**
**JASO T 903:2011 MA2**
**4 TIEMPOS  
4-STROKE ENGINE**

Tipo de Análisis	Método / Method	Resultado / Results
Grado SAE / Grade SAE		10W-40
Viscosidad a 100°C Viscosity at 40°C	ASTM D - 455	12.5 - 16.3
Viscosidad a -25°C Viscosity at -25°C	ASTM D - 5293	< 7000
Índice de Viscosidad Viscosity index	ASTM D - 2270	150
Punto de Inflamación Flash point	ASTM D - 92	197
Punto de congelación Freezing point	ASTM D - 97	-32°C
TBN (mg KOH/g)	ASTM D - 2896	> 6.0

ES El lubricante sintético 10W-40 es un aceite multigrado de base isomerizado mediante un proceso de hidrogenado y aditivos seleccionados.

FR Le lubrifiant synthétique 10W-40 est une huile multigrade avec une base isomérisée par un procédé hydrogéné et des additifs sélectionnés.

EN The 10W-40 product is a multigrade oil isomerized by a severe hydrogenated process and selected additives.

IT Il prodotto 10W-40 è un olio multigrado di base isomerizzato da un processo idrogenato severo e additivi selezionati.

PT O lubrificante sintético 10W-40 é um óleo multigraduado com uma base isomerizada por meio de um processo hidrogenado e aditivos selecionados.

ES Excelentes prestaciones en motores de gasolina o diésel, con aspiración normal o turboalimentados tanto en turismos como furgonetas. Buena viscosidad a baja temperatura, adecuada para permitir una lubricación rápida después del arranque en frío. Alta resistencia a la oxidación y protección contra el desgaste para maximizar la vida del motor. Gran propiedad de detergencia/dispersión para el mejor control del hollín. ACEA A3/B3/B4 - API SM/CF - MB 2291 BMW LL 01 - VW 500.00/501.01/505.00 -PORSCHE

FR ExcellenteS performanceS sur les moteurs à essence ou diesel, avec une aspiration normale ou turboalimentée sur les voitures et camionnettes. Bonne viscosité à basse température, adaptée à une lubrification rapide après démarrage à froid. Haute résistance à l'oxydation et protection contre l'usure pour maximiser la durée de vie du moteur. Grande propriété de détergence / dispersion pour un meilleur contrôle de la suie. ACEA A3 / B3 / B4 - API SM / CF - MB 2291 BMW LL 01 - VW 500.00 / 501.01 / 505.00 -PORSCHE

EN The product provides excellent service performances in engines powered by gasoline or diesel, with normal or turbocharged suction in both cars and vans. Good viscosity at low temperature, suitable for a quick lubrication after a cold start. High resistance to oxidation and protection against wear to maximize the life of the engine. Good detergency/dispersion properties for better soot control. ACEA A3/B3/B4 - API SM/CF - MB 2291 BMW LL 01 - VW 500.00/501.01/505.00 -PORSCHE

IT Il prodotto offre prestazioni di servizio eccellenti nei motori alimentati a benzina o diesel, con aspirazione normale o turbocompressa in auto e furgoni. Buon grado di viscosità a bassa temperatura, adatta per una rapida lubrificazione dopo l'avviamento a freddo. Elevata resistenza all'ossidazione e protezione dall'usura per massimizzare la vita del motore. Buone proprietà detergenti/dispersive per un miglior controllo della fuliggine. ACEA A3/B3/B4 - API SM/CF - MB 2291 BMW LL 01 - VW 500.00/501.01/505.00 -PORSCHE

PT Excelente prestação em motores de gasolina ou diesel, com aspiração normal ou turboalimentados para turismo ou carrinhas. Boa Viscosidade a baixa temperatura, adequada para permitir uma lubrificação rápida a seguir ao arranque a frio. Alta restência à oxidação e proteção contra o desgaste para maximizar a vida do motor. Ótima propriedade de detergência / dispersão para melhor controle da fuligem. ACEA A3/B3/B4 - API SM/CF - MB 2291 BMW LL 01 - VW 500.00/501.01/505.00 -PORSCHE

Ref				
<b>1550 2031</b>	1 L	1	18	<b>9,25</b>





JABÓN PARA TALLERES / SAVON POUR ATELIERS / HEAVY DUTY SOAP / SAPONE PER OFFICINA / SABONETE LÍQUIDO PARA OFICINAS



- ES Detergente líquido para el lavado de manos con un alto poder desengrasante. Se respeta el equilibrio hídrico de la piel. Recomendado para la limpieza de suciedad tenaz.
- FR Détergent liquide pour les mains à fort pouvoir dégraissant. Garantit un nettoyage efficace tout en respectant l'équilibre de l'épiderme.
- EN Detergent hand-wash soap with strong degreasing power. It respects the skin water equilibrium and it is suitable for cleaning heavy-duty stains.
- IT Liquido detergente lavamani ad alto potere sgrassante. Rispetta l'equilibrio idrolipidico della pelle. È consigliato per la pulizia di sporchi tenaci.
- PT Detergente líquido mão com um alto poder desgordurante. Respeita o equilíbrio de hidratação da pele. Recomendado para limpeza de tenaz suja.

Ref				
1500 0075	1 L	1	12	8,19

JABÓN PARA OFICINAS / SAVON POUR BUREAUX / SOAP FOR OFFICE USE / SAPONE PER UFFICIO / SABONETE LÍQUIDO PARA ESCRITÓRIOS



- ES Detergente líquido cremoso perlado que garantiza, gracias a las propiedades calmantes, una epidermis delicada. ideal para oficinas, restaurantes y bares.
- FR Crème lavante pour les mains, garantit un nettoyage efficace tout en respectant l'équilibre de l'épiderme. Idéale pour les bureaux, restaurants, bars.
- EN Creamy liquid soap that treats delicatly the skin. The product holds moisturizing properties. Ideal for offices, restaurants and bars.
- IT Sapone liquido cremoso. Garantisce un lavaggio delicato dell'epidermide, ideale per ufficio, ristoranti, bar e convivenze.
- PT Sabão líquido cremoso perolada que garante, graças ás propriedades calmantes, uma lavagem epiderme delicada. Ideal para escritórios, restaurantes e bares.

Ref				
1500 0076	1 L	1	12	6,30

PASTA LAVAMANOS CON PARTÍCULAS / SAVON POUR LES MAINS AVEC PARTICULES / THICK SOAP WITH PARTICLES FOR HANDS  
PASTA LAVAMANI CON PARTICELLE / MASSA LAVA MAOS COM PARTICULAS



- ES Pasta lavamanos con partículas desincrustantes para una limpieza rápida y profunda. Para el lavado de manos de mecánicos, carroceros, transportistas, industrias y construcción. No afecta a la piel.
- FR Pâte pour se laver les mains avec particules désincrustantes pour une propreté rapide et profonde. Pour le lavage des mains des mécaniciens, carrossiers, transporteurs, industriels et travaux de construction. N'affecte pas la peau.
- EN Pasty handwasher with descaling particles for a fast and clean. Ideal for mechanics, road hauliers, industries and building site. It does not affect the skin.
- IT Pasta lavamani con particelle disincrostanti per una pulizia rapida e profonda. Per il lavaggio della mani di meccanici, carrozzieri, trasportatori, in ambito industriale ed edile. Non danneggia la pelle.
- PT Massa lava maos com particulas desincrustantes para uma limpeza rápida e profunda. Para o lavagem das maos de mecânicos, carroçarias, transportadores, industrias e construção. Nao afecta a pele.

Ref				
1500 0020	1 Kg	1	12	5,94
1500 0021	4 Kg	1	6	17,60

GEL LAVAMANOS PERFUMADO CON PROTECCIÓN 5L / GEL LAVANT POUR LES MAINS PARFUMÉ AVEC PROTECTION  
PERFUMED HAND CLEANING GEL WITH PROTECTION / GEL LAVAMANI PROFUMATO CON PROTEZIONE / GEL LAVA MAOS PERFUMADO COM PROTECÇÃO



- ES Gel lavamanos en crema perfumada y con protectores para la piel. Para el lavado de manos de mecánicos, carroceros, transportistas, artesanos, etc. No afecta a la piel.
- FR Gel lave-mains en crème parfumée avec protection pour la peau. pour le lavage des mains des mécaniciens, carrossiers, transporteurs, artisans, etc... N'affecte pas la peau.
- EN Gel handwasher on perfumed cream with protection for the skin. Ideal for mechanics, road hauliers, industries and building site. It does not affect the skin.
- IT Gel lavamani in crema profumata e con protezioni per la pelle. Per il lavaggio della mani di meccanici, carrozzieri, trasportatori, artigiani, ecc...Non danneggia la pelle.
- PT Gel lava maos em creme perfumado e com protectores para a pele. Para a lavagem das maos de mecânicos, carroçarias, transportadores, artesaos, etc.. Nao afecta a pele.

Ref				
1500 0022	5 L	1	4	48,40

**ACEITE HIDRÁULICO 5 L / HUILE HYDRAULIQUE 5L / HYDRAULIC OIL 5L / OLIO IDRAULICO 5L / OLIO IDRAULICO 5L**

**ISO VG46**

**ISO VG68**

ES Aceite hidráulico mineral monogrado de extrema presión y de avanzada tecnología especialmente indicado para cualquier sistema o circuito hidráulico.

FR Huile hydraulique minérale monograde extrême pression et technologie de pointe particulièrement adaptée à tout système ou circuit hydraulique.

EN Monograde hydraulic of extreme pressure and advanced technology. It is specially intended for any system or hydraulic circuit.

IT Olio idraulico monogrado di estrema pressione, tecnologia avanzata particolarmente adatta a qualsiasi sistema o circuito idraulico.

PT Óleo hidráulico mineral monogrado de extrema pressão, de avançada tecnologia especialmente indicado para qualquer sistema de circuito hidráulico.

**MAGIAS P68-P69-P70**
**AFNOR NF E 48603 HM**
**Eaton Vickers I286S (Industrial), M-2950-S (Mobile)**
**PARKER DENISON HF0, HF1, HF2**
**ISO 6743/4 HM**
**ISO VG46**
**DIN 51524 Part 2 HLP**
**ISO VG68**

ES HM/HLP 46 / HM/HLP 68. Buen índice de viscosidad. Excelente nivel de extrema presión. Muy buenas cualidades antioxidantes, anticorrosivas, antiespumantes y antidesgaste. Gran poder de desmenución.

FR HM/HLP 46 / HM/HLP 68. Bon indice de viscosité. Excellent niveau de pression extrême. Très bonnes qualités oxydantes, anti-corrosives, anti-mousse et anti-usure. Grande puissance de désémulsification.

EN HM/HLP 46 / HM/HLP 68. Good viscosity rate. Excellent level of extreme pressure. Excellent anti-rust, anti-corrosion, anti-foaming and anti-wear capacity. Great power of desmulsion.

IT HM/HLP 46 / HM/HLP 68. Buon indice di viscosità. Eccellente livello di estrema pressione. Ottime proprietà antiossidanti, anticorrosive, anti-schiuma e antiusura. Grande potere di desmulsion.

PT HM/HLP 46 / HM/HLP 68. Bom índice de viscosidade. Excelente nível de extrema pressão. Boa qualidade antioxidante, anticorrosiva, antiespumante e antidesgaste. Grande poder de desmulsificação.

Tipo de Análisis Type of Analysis	Método Method	Resultado Results	
ISO		46	68
Viscosidad a 40°C. (cSt) Viscosity at 40°C (cSt)	ASTM D - 445	41,4 / 50,6	61,2 / 74,8
Índice de Viscosidad min. Minimum viscosity index.	ASTM D - 2270	105	105
Punto de inflamación min. (°C) Minimum flash point (°C)	ASTM D - 92	224	235
Punto de congelación máx. (°C) Maximum freezing point (°C)	ASTM D - 97	-24	-24

Ref				
<b>1550 2026</b>	5 L	1	5	<b>30,54</b>
<b>1550 2027</b>	5 L	1	5	<b>30,54</b>

**GRASA LITIO ISO 6743/9 EP / GRAISSE AU LITHIUM ISO 6743/9 EP / LITHIUM GREASE ISO 6743/9**
**GRASSO AL LITIO ISO 6743/9 EP / LUBRIFICANTE DE LITIO ISO 6743/9 EP**

**5 KG**

**Cartucho / Cartridge**
**400 G**

ES Grasa de extrema presión multifuncional para rodamientos, reductores y engrase general en industria y automoción.

FR Graisse multifonctionnelle de pression extrême pour roulements, réducteurs et lubrification générale dans l'industrie et l'automobile.

EN Multifunctional Grease of extreme pressure suitable for bearings, reducers or general greasing for the industry and automotive sector.

IT Grasso multifunzionale di pressione estrema indicato per cuscinetti, riduttori o lubrificazioni in generale per l'industria e il settore automobilistico.

PT Massa consistente de extrema pressão multifuncional para rolamentos, redutores e lubrificação geral na indústria e no setor automotivo.

ES DIN 51502 KP2K-30. ISO 6743/9. GRADO NLGI2. ASTM D4950 "LB" para automoción. Punto de gota 220°C. Temperatura de trabajo -30°C A +140°C (Puntas de hasta 165°C). Color Ámbar.

FR DIN 51502 KP2K-30. ISO 6743/9. GRADE NLGI2. ASTM D4950 «LB» pour l'automobile. Point de chute: ≥ 220°C. Température de fonctionnement -30°C A + 140°C (Points jusqu'à 165°C). Couleur ambre.

EN DIN 51502 KP2K-30. ISO 6743/9 L-XCDEB-2 , NLGI2 Degree. ASTM D4950 "LB" for automotive use. Drop point: ≥ 220°C. Working temperature from -30°C to +140°C (with peak of up to +165°C). Colour amber.

IT DIN 51502 KP2K-30. ISO 6743/9 L-XCDEB-2. GRADO NLGI2. ASTM D4950 "LB" per uso automobilistico. Punto di gocciolamento: ≥ 220°C. Temperatura di esercizio dal -30°C al +140°C (con picchi fino a +165°C). Colore ambra.

PT DIN 51502 KP2K-30. ISO 6743/9. GRAU NLGI2. ASTM D4950 "LB" para automação. Ponto de gota 220°C. Temperatura de trabalho -30°C A +140°C (Pontas até 165°C). Cor Ámbar.

Características Specifications	Norma Regulation	Valor Value
Consistencia (Grado NLGI) Consistency (NLGI Grade)	DIN 51818	2
Color / Colour	Visual	Ámbar
Aceite base (Grado de viscosidad ISO) Base Oil (ISO Viscosity Grade)	ISO 3448	100 / 150
Punto de gota, °C / (°F) Drip point °C (°F)	ASTM D - 2265	≥ 220 (428)
Carga Timken, OK, lb / Timken OK Load, lb	ASTM D - 2509	45
Test Desgaste, 4 Bolas (40 kg / 1200 rpm / 75°C / 1h) Huella (mm) Four-Ball Wear (40 kg / 1200 rpm / 75°C / 1h) wear scars (mm)	ASTM D - 2266	< 0,50

Ref				
<b>1550 2028</b>	5 kg	1	1	<b>55,15</b>
<b>1550 2029</b>	400 g	1	34	<b>7,17</b>

**Cartucho / Cartridge**



**ESCOBILLA LIMPIAPARABRISAS FLEXIBLE / BALAIS ESSUIE-GLACE FLEXIBLES / FLEXIBLE WINDSHIELD WIPER  
SPAZZOLE TERGICRISTALLI FLESSIBILI / ESCOVAS LIMPIA PARA-BRISAS FLEXÍVELS**

- ES **100% Goma Natural.**
- FR **Caoutchouc 100% naturel.**
- EN **100% natural rubber.**
- IT **100% gomma naturale.**
- PT **100% borracha natural.**

Adaptadores para el de los vehículos **95%**



ES Silenciosas y Flexibles. Máxima Calidad de Barrido. Testada Laboratorio A.R.D.L de USA. Resistentes al ozono, humedad salina, al calor, hielo y nieve.

FR Silencieux et flexible. Qualité de balayage maximum. Laboratoire A.R.D.D.L. des USA. Résistant à l'ozone, à l'humidité saline, à la chaleur, à la glace et à la neige.

EN Silent & flexible wiper. Maximum sweep quality. Tested by A.R.D.L. laboratory from USA. It is ozone, salt moisture, snow, heat, and ice resistant.

IT Silenziose e flessibile. Massima qualità nella battuta. Testata dal laboratorio A.R.D.L. in USA. Resistente all'ozono, umidità salina, al calore, freddo e alla neve.

PT Silenciosas e flexíveis. Máxima qualidade de limpeza. Testada no Laboratório A.R.D.L. de EUA. Resistente ao ozono, humidade salina, ao calor, gelo e neve.

Ref	↔	📦
<b>0340 1141</b>	16" - 41 cm	<b>9,43</b>
<b>0340 1145</b>	18" - 45 cm	<b>9,43</b>
<b>0340 1148</b>	19" - 48 cm	<b>9,43</b>
<b>0340 1151</b>	20" - 51 cm	<b>9,43</b>
<b>0340 1153</b>	21" - 53 cm	<b>9,43</b>
<b>0340 1155</b>	22" - 55 cm	<b>9,43</b>
<b>0340 1160</b>	24" - 60 cm	<b>9,43</b>
<b>0340 1162</b>	26" - 65 cm	<b>13,53</b>
<b>0340 1170</b>	28" - 70 cm	<b>13,53</b>

**ESCOBILLA LIMPIAPARABRISAS DE METAL / BALAIS ESSUIE-GLACE EN MÉTAL / METAL WINDSHIELD WIPER  
SPAZZOLE TERGICRISTALLI IN METALLO / ESCOVAS LIMPIA PARA-BRISAS DE METAL**

- ES **100% Goma de Alta Calidad.**
- FR **100% caoutchouc de haute qualité.**
- EN **100% high quality rubber.**
- IT **100% gomma di alta qualità.**
- PT **100% borracha de alta qualidade.**



ES Recubrimiento de Politetrafluoroetileno. Óptima calidad de barrido.

FR Revêtement de polytetrafluoroéthylène. Qualité de balayage optimale.

EN Polytetrafluoroethylene coating. High sweep quality.

IT Rivestimento in politetrafluoroetilene. Ottima qualità nella battuta.

PT Recubrimento de politetrafluoroetileno. Ótima qualidade de limpeza.

Ref	↔	📦
<b>0340 1228</b>	11" - 28 cm	<b>3,85</b>
<b>0340 1233</b>	13" - 33 cm	<b>3,85</b>
<b>0340 1235</b>	14" - 35 cm	<b>3,85</b>
<b>0340 1238</b>	15" - 38 cm	<b>3,85</b>
<b>0340 1241</b>	16" - 41 cm	<b>3,85</b>
<b>0340 1243</b>	17" - 43 cm	<b>3,85</b>
<b>0340 1245</b>	18" - 45 cm	<b>3,85</b>
<b>0340 1248</b>	19" - 48 cm	<b>3,85</b>
<b>0340 1251</b>	20" - 51 cm	<b>3,85</b>
<b>0340 1253</b>	21" - 53 cm	<b>3,85</b>
<b>0340 1255</b>	22" - 55 cm	<b>3,85</b>
<b>0340 1260</b>	24" - 60 cm	<b>3,85</b>
<b>0340 1265</b>	26" - 65 cm	<b>4,92</b>
<b>0340 1270</b>	28" - 70 cm	<b>4,92</b>

**ESCOBILLA LIMPIAPARABRISAS TRASERA / BALAIS ESSUIE-GLACE ARRIÈRE / REAR WINDSHIELD WIPER  
SPAZZOLE TERGICRISTALLI POSTERIORE / ESCOVAS LIMPIA PARA-BRISAS**

- ES **100% Goma de Alta Calidad.**
- FR **100% Caoutchouc de haute qualité.**
- EN **100% high quality rubber.**
- IT **100% gomma di alta qualità.**
- PT **100% borracha de alta qualidade.**



ES Recubrimiento de Politetrafluoroetileno. Óptima calidad de barrido.

FR Revêtement de polytetrafluoroéthylène. Qualité de balayage optimale.

EN Polytetrafluoroethylene coating. High sweep quality.

IT Rivestimento in politetrafluoroetilene. Ottima qualità nella battuta.

PT Recubrimento de politetrafluoroetileno. Ótima qualidade de limpeza.



Adaptadores para el de los vehículos **98%**

Ref	↔	📦
<b>0340 1297</b>	12" - 30 cm	<b>8,20</b>
<b>0340 1298</b>	14" - 35 cm	<b>8,20</b>
<b>0340 1299</b>	16" - 40 cm	<b>8,20</b>



MUELLE NEUMÁTICO UNIVERSAL / VÉRIN DE HAYON PNEUMATIQUE UNIVERSEL / UNIVERSAL GAS SPRING  
 AMMORTIZATORE PNEUMATICO UNIVERSALE / MOLLA PNEUMÁTICA UNIVERSAL

ES **Resortes de gas nitrógeno.**  
 FR **Ressorts en gaz azote.**  
 EN **Nitrogen Gas Spring Struts.**  
 IT **Molle a gas azoto.**  
 PT **Molas a gás nitrogênio.**

ES **Cuerpo en acero esmaltado.**  
 FR **Corps en acier émaillé.**  
 EN **Enamelled steel body.**  
 IT **Corpo in acciaio smaltato.**  
 PT **Corpo em aço esmaltado.**



Ref	∅	∅		NEWTONS		
0340 2012	8 mm	18 mm	200 mm	350	55 mm	14,76
0340 2023	8 mm	18 mm	250 mm	350	80 mm	14,76
0340 2033	8 mm	18 mm	300 mm	350	105 mm	14,76
0340 2042	8 mm	18 mm	325 mm	350	120 mm	14,76
0340 2053	8 mm	18 mm	350 mm	350	130 mm	14,76
0340 2062	8 mm	18 mm	375 mm	350	145 mm	14,76
0340 2074	8 mm	18 mm	400 mm	350	155 mm	14,76
0340 2078	8 mm	18 mm	400 mm	550	155 mm	14,76
0340 2083	8 mm	18 mm	425 mm	350	170 mm	14,76
0340 2086	8 mm	18 mm	425 mm	550	170 mm	14,76
0340 2093	8 mm	18 mm	450 mm	350	180 mm	14,76
0340 2097	8 mm	18 mm	450 mm	550	180 mm	14,76
0340 2104	8 mm	18 mm	475 mm	350	195 mm	14,76
0340 2107	8 mm	18 mm	475 mm	550	195 mm	14,76
0340 2114	8 mm	18 mm	500 mm	350	205 mm	14,76
0340 2118	8 mm	18 mm	500 mm	550	205 mm	14,76
0340 2124	8 mm	18 mm	525 mm	350	220 mm	14,76
0340 2127	8 mm	18 mm	525 mm	550	220 mm	14,76
0340 2133	8 mm	18 mm	550 mm	350	230 mm	14,76
0340 2137	8 mm	18 mm	550 mm	550	230 mm	14,76
0340 2144	8 mm	18 mm	575 mm	350	245 mm	14,76
0340 2147	8 mm	18 mm	575 mm	550	245 mm	14,76
0340 2152	8 mm	18 mm	600 mm	350	255 mm	14,76
0340 2156	8 mm	18 mm	600 mm	550	255 mm	14,76
0340 2163	8 mm	18 mm	625 mm	350	270 mm	14,76
0340 2166	8 mm	18 mm	625 mm	550	270 mm	14,76
0340 2173	8 mm	18 mm	650 mm	350	280 mm	14,76
0340 2177	8 mm	18 mm	650 mm	450	285 mm	14,76

ES **Cabezal incluido x2**  
 FR **Tête incluse x2**  
 EN **2 end fittings included**  
 IT **2 testine inclusi**  
 PT **Cabeçal incluido x2**

2 UDS. ACCESORIO OJAL MUELLE NEUMÁTICO 8 MM / 2 PCS. ACCESSOIRE OEILLET DE VÉRIN DE HAYON 8 MM / 2 PCS. EYELETS GAS SPRING END FITTINGS 8 MM / 2 UNITÀ ACCESSORIO CON OCCHIELLO MOLLA A GAS 8 MM



Ref			
0340 2199.2	1	1	3,10

2 UDS. ACCESORIO ALARGADOR MUELLE NEUMÁTICO 8 MM / 2 PCS. ACCESSOIRE RALLONGE VERRIN PNEUMATIQUE 8 MM / 2 PCS. FEMALE THREADS GAS PRING END FITTINGS 8 MM / 2 UNITÀ ACCESSORIO CONNETTORI ESTENSIONE MOLLA A GAS 8 MM / 2 UNI. ALARGADOR DE MOLLA PNEUMÁTICA 8 MM



Ref			
0340 2199.3	1	1	3,10





2 UDS. ACCESORIO RÓTULA MACHO MUELLE NEUMÁTICO 8 MM / 2 PCS. ACCESSOIRE ROTULE MALE VERRIN PNEUMATIQUE 8 MM  
 2 PCS. THREADED BALL STUDS GAS SPRING END FITTINGS 8 MM / 2 UNITÀ ACCESSORIO PERON A SFERA MOLLA A GAS 8 MM  
 2 UNI. RÓTULA MACHO DE MOLA PNEUMÁTICA



Ref			
0340 2199.4	1	1	3,10

2 UDS. ACCESORIO RÓTULA 15° MUELLE NEUMÁTICO 8 MM / 2 PCS. ACCESSOIRE ROTULE 15° VERRIN PNEUMATIQUE 8 MM  
 2 PCS. BALL SOCKET 15° GAS SPRING END FITTINGS 8 MM / 2 UNITÀ ACCESSORIO TESTA A SFERA 15° MOLLA A GAS  
 2 UNI. RÓTULA 15° MOLA PNEUMÁTICA 8 MM



Ref			
0340 2199.5	1	1	3,10

**PINZAS ARRANQUE / COLLIERS DE DEMARRAGE / JUMP LEADS  
 CAVI DI AVVIAMENTO / PINZAS ARRANQUE**

PINZAS ARRANQUE AISLADAS COBRE Y ACERO / COLLIERS DE DEMARRAGE ISOLÉS CUIVRE Y ACIER / ISOLATED COPPER ET STEEL JUMP LEADS  
 CAVI DI AVVIAMENTO IN RAME & ACCIAIO / PINZAS ARRANQUE AISLADAS COBRE E AÇO



**400 AMP Cable 3m + pinzas**

ES Apto para todo tipo de baterías de coche, camiones, barcas, motos y otros vehículos con batería de 12-24V.

FR Convient à tous les types de batteries des voitures, des camions, des bateaux, des motos et d'autres véhicules avec batterie 12-24V.

EN It is suitable for all kind of vehicles with 12-24V batteries (cars, lorries, boats, motorbikes, etc.)

IT È adatto per tutti i tipi di batterie per auto, camion, barche, motocicletta e altri veicoli con batteria di 12-24V.

PT Adequado para todos os tipos de baterias de automóveis, caminhões, barcos, motos e outros veículos com bateria de 12-24V.

Ref	A		
0350 0400	400	18 mm <sup>2</sup> (0,31 mm x 239 mm x Ø 9 mm)	1 30,95

PINZAS ARRANQUE AISLADAS ZINC Y ACERO / COLLIERS DE DEMARRAGE ISOLÉS ZINC Y ACIER / ISOLATED ZINC ET STEEL JUMP LEADS  
 CAVI DI AVVIAMENTO IN ZINCO & ACCIAIO / PINZAS ARRANQUE AISLADAS ZINCO E AÇO



**600 AMP Cable 3m + pinzas**

ES Apto para todo tipo de baterías de coche, camiones, barcas, motos y otros vehículos con batería de 12-24V.

FR Convient à tous les types de batteries des voitures, des camions, des bateaux, des motos et d'autres véhicules avec batterie 12-24V.

EN It is suitable for all kind of vehicles with 12-24V batteries (cars, lorries, boats, motorbikes, etc.)

IT È adatto per tutti i tipi di batterie per auto, camion, barche, motocicletta e altri veicoli con batteria di 12-24V.

PT Adequado para todos os tipos de baterias de automóveis, caminhões, barcos, motos e outros veículos com bateria de 12-24V.

Ref	A		
0350 0600	600	38,26 mm <sup>2</sup> (0,32 mm x 476 mm x Ø 13 mm)	1 57,24





FARO DE TRABAJO 16 LED / LAMPE DE TRAVAIL 16 LED / 16 LED WORK LAMP / FARO DA LAVORO 16 LED / FOCO TRABALHO 16 LED



IP67 (10-30V)  
16 LED

Ref	W	⊙	Lm	Nº LED	📦	🔌
199 081	48 W	6000K	3360 lm	16	1	28,75

ES Iluminación de los objetos, temperatura del color: 6000° Kelvin, consumo de potencia: 3 W/led, tipo de protección IP 67 (resiste el lavado a alta presión), carcasa de aluminio, multivoltaje: 10-30V, protección ante polaridad inversa, homologación CEE 10. Vehículo industrial: tractores, cosechadores, vehículos especiales, sector agrícola, construcción, comercial y forestal.

FR Éclairage d'objets, température de couleur: 6000° Kelvin". Puissance consommée: 3W/led. Type de protection IP 67 (résistant au lavage à haute pression)". Boîtier en aluminium. Multi-tension: 10-30V. Protection contre la polarité inverse. Homologation CEE 10. "Véhicule utilitaire: tracteur, récolteuse, véhicules spéciaux à le secteur agricole, de la construction et forestier.

EN Objects lightning, color temperature: 6000° Kelvin". Power consumption: 3W/led. Type of protection: IP 67 (resistant to high-pressure washing). Aluminium housing. Multi-voltage: 10-30V. Protection against reversed polarity. EEC 10 type-approval. Commercial vehicle: tractors, harvester, special vehicles on agricultural, construction, commercial, and forestry sectors."

IT "Illuminazione di oggetti, temperatura di colore: 6000° Kelvin. Potenza assorbita: 3W/led. Tipo di protezione PID (resistente ad il lavaggio ad alta pressione). Involucro in alluminio. Multivoltaggio: 10-30V. Protezione contro la polarità inversa. Omologazione CEE 10. Veicolo commerciale: trattore, harvester, veicolo speciale nel settore agricolo, delle costruzioni e forestale.

PT Iluminação de objetos, temperatura da cor: 6000° Kelvin." Consumo de potência: 3W/led. Tipo de proteção IP (resistente al lavagem a alta pressão). Carcaça de alumínio. Multi-voltagem: 10-30V. Proteção contra la polaridade inversa. Homologação CEE 10. Veículo industrial: trator, máquina de colheita, veículo especial em sector agrícola, da construção, delle costruzioni e sector florestal.



IP67 (10-30V)  
14 LED

Ref	W	⊙	Lm	Nº LED	📦	🔌
199 082	42 W	6000K	2940 lm	14	1	28,18

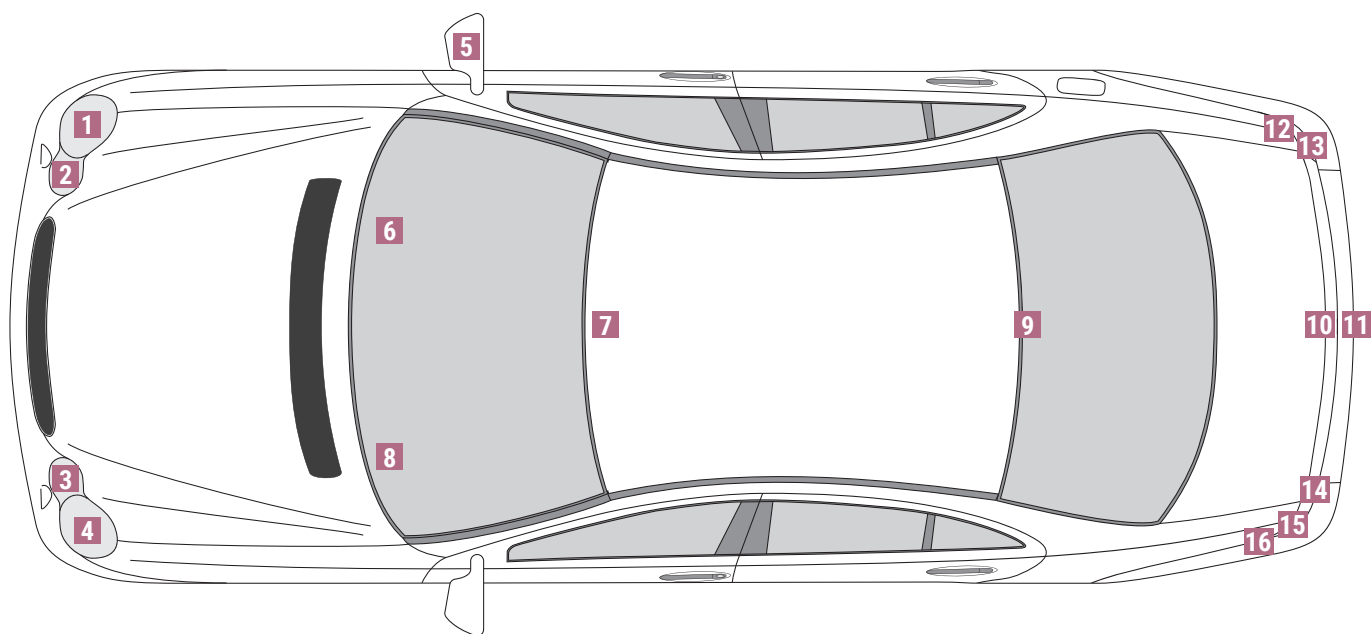

**1** Luces de carretera / Feux de route  
Full beam headlights / Luci stradali  
Luzes de cruzamento (médios)



**2** Luces intermitentes delanteros  
Feux clignotant avant  
Front indicator lights  
Luci direzionali  
Luzes de mudança de direção dianteiros (piscas)



**3** Luces delanteras de niebla  
Feux anti-brouillard avant  
Front fog lights  
Fendinebbia anteriori  
Luzes de nevoeiro dianteiras



**4** Luces delanteras de posición  
Feux de position avant  
Parking lights  
Luci anteriori di posizione  
Luzes de presença dianteiras (mínimos)



**5** Luces intermitentes laterales  
Feux clignotant latéraux  
Side indicator lights  
Luci intermittenti laterali  
Indicadores de mudança de direção laterais (piscas)



**6** Luz de guantera  
Ampoule éclairage boîte à gants  
Glove compartment light  
Luce vano portaoggetti  
Luz do guarda-luvas



**7** Iluminación Interior  
Ampoule éclairage intérieur / Interior lighting  
Illuminazione interna / Iluminação interior



**8** Luces de salpicadero  
Ampoule éclairage tableau de bord  
Dashboard lights  
Luci del cruscotto  
Luzes do painel



**9** Tercera luz de frenado / Troisième feu stop  
Third brake light / Luci stop  
Terceira luz de travão



**10** Luz del maletero / Ampoule éclairage coffre  
Boot light / Luce bagagliaio  
Luz da bagageira



**11** Lámpara de placa de matriculación  
Ampoule de plaque d'immatriculation  
Number plate light  
Lampadina targa  
Lâmpada da chapa da matrícula



**12** Luces traseras de niebla  
Feux anti-brouillard arrière  
Rear fog lights  
Luci fendinebbia posteriori  
Luzes de nevoeiro traseiras



**13** Luces de frenado / Feux stop  
Brake lights / Luci di frenata  
Luzes do travão



**14** Luces de marcha atrás / Feux de recul  
Reversing lights / Luci retromarcia  
Luzes de marcha atrás



**15** Luces traseras de posición  
Feux de position arrière  
Tail lights  
Luci posteriori di posizione  
Luzes de presença traseiras (mínimos)



**16** Luces intermitentes traseras  
Feux clignotant arrière  
Rear indicators  
Luci intermittenti posteriori  
Luzes de mudança de direção traseiros (piscas)



	Ref	V	W		MODEL		
	<b>PY21</b>	<b>0350 1210A</b>	12 V	21 W	1 POLO P21W (BA15s)	ÁMBAR	10 <b>0,56</b>
	<b>P-21</b>	<b>0350 1210</b>	12 V	21 W	1 POLO P21W (BA15s)		10 <b>0,48</b>
	<b>P-21 (D)</b>	<b>0350 1210Y</b>	12 V	21 W	1 POLO P21W (BAU15s)	DESCENTRADA	10 <b>0,68</b>
	<b>P-21/5</b>	<b>0350 1220</b>	12 V	21/5 W	2 POLOS P21/5W (BAY15d)		10 <b>0,48</b>
	<b>T4W</b>	<b>0350 1223</b>	12 V	4 W	CONTROL T4W (BA9s)		10 <b>0,31</b>
	<b>R10W</b>	<b>0350 1222</b>	12 V	10 W	PILOTO R10W (BA15s scc)		10 <b>0,37</b>
	<b>R5W</b>	<b>0350 1221</b>	12 V	5 W	PILOTO R5W (BA15s scc)		10 <b>0,44</b>
	<b>W1.2</b>	<b>0350 1231</b>	12 V	1.2 W	S/CASQUILLO W1,2-T5 (W2x4,6d)		10 <b>0,37</b>
	<b>WY5</b>	<b>0350 1232A</b>	12 V	5 W	S/CASQUILLO W5W (W2,1x9,5)	ÁMBAR	10 <b>0,40</b>
	<b>W-5</b>	<b>0350 1233</b>	12 V	5 W	S/CASQUILLO W5W (W2,1x9,5d)		10 <b>0,32</b>
	<b>C10W</b>	<b>0350 1240</b>	12 V	10 W	PLAFONIER C10W	Ø11x31 mm	10 <b>0,35</b>
	<b>C10W</b>	<b>0350 1246</b>	12 V	10 W	PLAFONIER C10W	Ø11x38 mm	10 <b>0,37</b>
	<b>C5W</b>	<b>0350 1241</b>	12 V	5 W	PLAFONIER C5W	Ø11x38 mm	10 <b>0,37</b>
	<b>C5W</b>	<b>0350 1245</b>	12 V	5 W	PLAFONIER C5W	Ø11x44 mm	10 <b>0,35</b>
	<b>H-6W</b>	<b>0350 1235</b>	12 V	6 W	HALÓGENA MINI H-6W BAX9s	MINI	10 <b>3,43</b>
	<b>R-2</b>	<b>0350 1200</b>	12 V	40V/45W	EUROP ( P45t ASY) 40V/45W		1 <b>1,82</b>
	<b>H-1</b>	<b>0350 1201</b>	12 V	55 W	HALÓGENA <b>H1</b> (P14,5S) 55W		1 <b>1,87</b>
	<b>H-4</b>	<b>0350 1204</b>	12 V	60/55 W	HALÓGENA <b>H4</b> (P43t) 60/55W		1 <b>3,29</b>
	<b>H-7</b>	<b>0350 1207</b>	12 V	55 W	HALÓGENA <b>H7</b> (Px26d) 55W		1 <b>2,79</b>



LÁMPARA HALÓGENA / AMPOULE COFAN / COFAN BULB / LAMPADINA COFAN / LÂMPADA COFAN

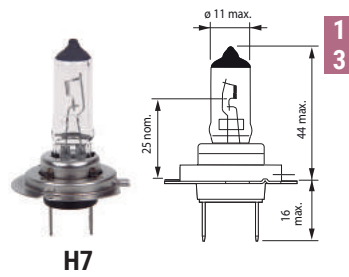
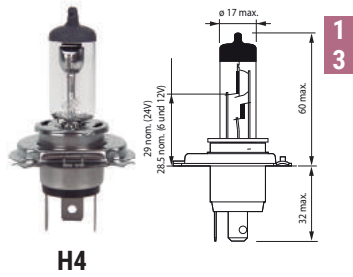
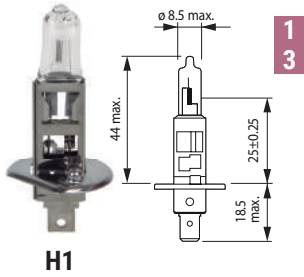

LÁMPARA FOCO EUROPEO  
AMPOULE CODE EUROPÉEN / CAR LAMP EUROPEAN LIGHT BULB  
LAMPADINA PER AUTO FUOCO EUROPEO  
LÂMPADA COFAN PARA AUTOMOVEL EUROPEU

PACK 10 UDS LÁMPARA 2 POLOS / AMPOULE COFAN 2 PÔLES  
DOUBLE POLE COFAN BULB  
LAMPADINA COFAN 2 POLI / LÂMPADA COFAN 2 POLOS

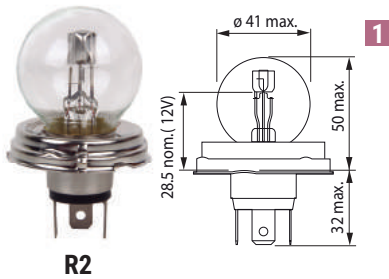

PACK 10 UDS LÁMPARA PILOTO / AMPOULE COFAN PILOTE / PILOT COFAN BULB / LAMPADINA COFAN PILOTA / LÂMPADA COFAN FAROLIM

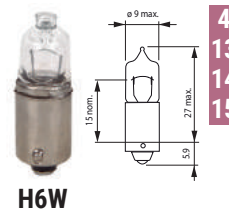
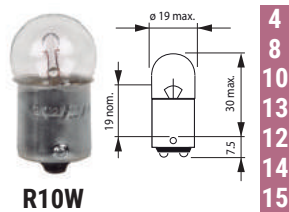
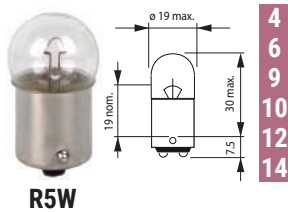

P21

DESCENTRADA

ÂMBAR / AMBRE / AMBER  
AMBRA / ÂMBAR

PACK 10 UDS LÁMPARA CONTROL  
AMPOULE COFAN / COFAN BULB  
LAMPADINA COFAN / LÂMPADA COFAN

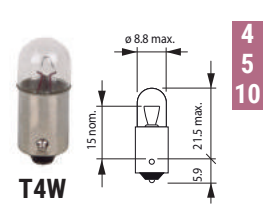
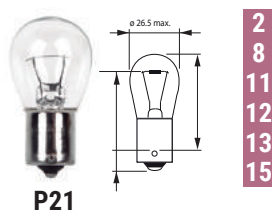

PACK 10 UDS LÁMPARA SIN CASQUILLO / AMPOULE SANS DOUILLE / BULB WITHOUT BULBHOLDER / LAMPADINA SENZA BASE / LÂMPADA SEM CASQUILHO

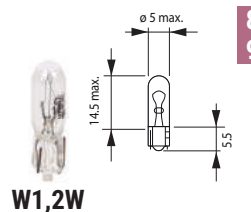
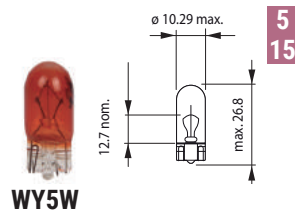
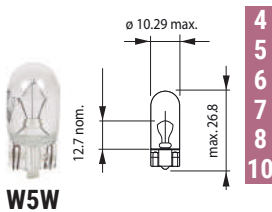



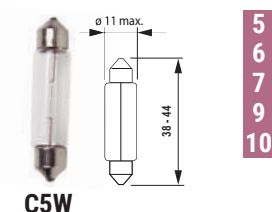



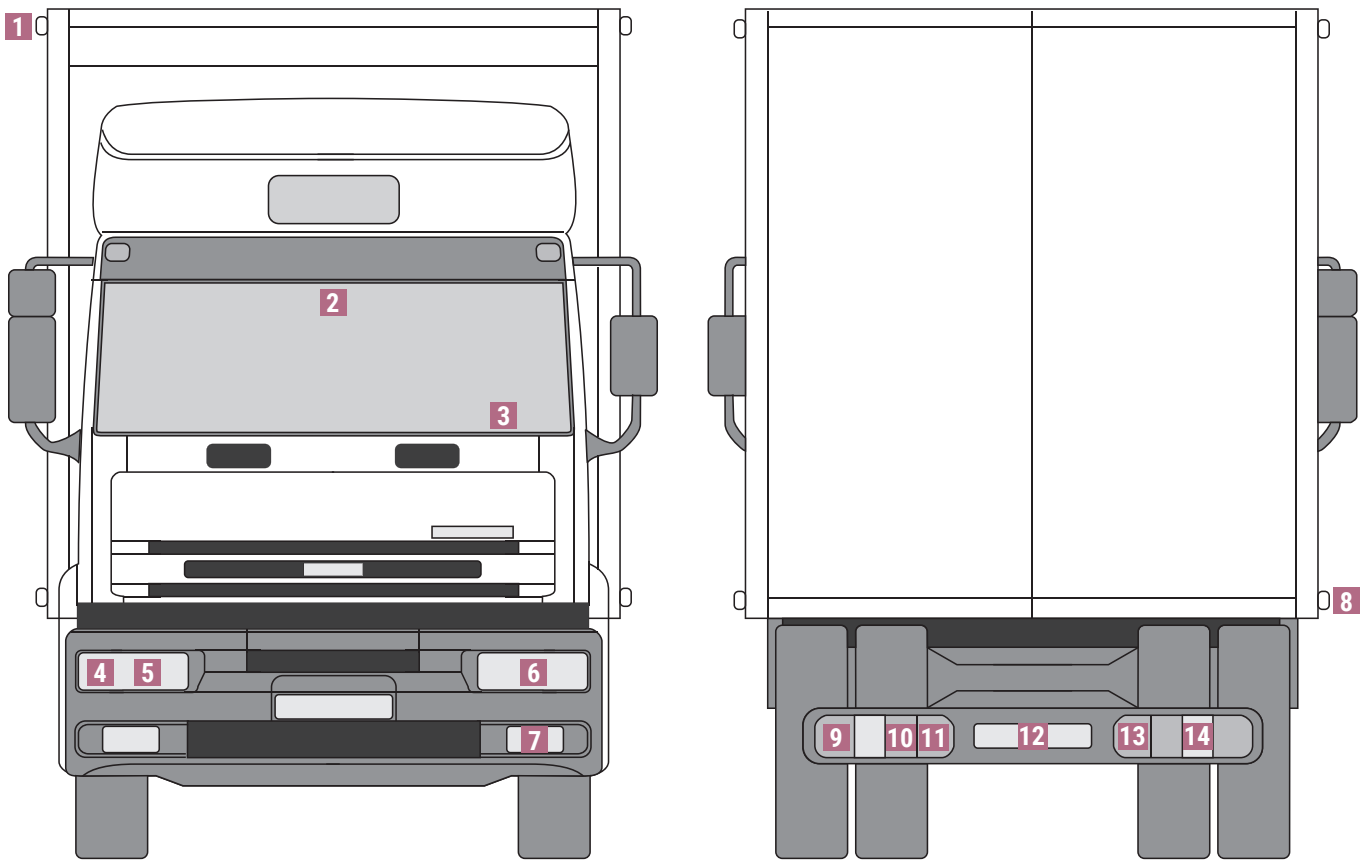







PACK 10 UDS LÁMPARA PLAFONIER / AMPOULE PLAFONIER / BULB PLAFONIER / LAMPADINA PLAFONIERA / LÂMPADA PLAFONIER



Las lámparas halógenas Cofan cumplen las normas europeas y garantizan una excelente calidad.  
The cofan halogen lamps fulfill the European norms and guarantee an excellent quality.  
Les lampes halogènes cofan répondent aux normes européennes et garantissent une excellente qualité.  
As lâmpadas halogênio cofan cumprem as normas europeias e garantem uma qualidade excelente.  
Le lampade dell'halogeno cofan compiono le norme europee e garantiscono una qualità eccellente.



<b>1</b>	<p>Luces de situación anchura y altura Ampoule d'indication largeur et hauteur Marker lights Indicatori di larghezza e altezza Luzes delimitadoras largura e altura</p> 	<b>8</b>	<p>Luces intermitentes laterales Feux clignotant latéraux Side indicator lights Luci intermittenti laterali Indicadores de mudança de direção laterais (piscas)</p> 	<b>12</b>	<p>Lámpara de placa de matriculación Ampoule de plaque d'immatriculation Number plate light Lampadina targa Lâmpada da chapa da matrícula</p> 
<b>2</b>	<p>Iluminación Interior Ampoule éclairage Intérieur / Interior lighting Illuminazione interna / Iluminação interior</p> 	<b>9</b>	<p>Luces intermitentes traseras Feux clignotant arrière Rear indicators Luci intermittenti posteriori Luzes de mudança de direção traseiros (piscas)</p> 	<b>13</b>	<p>Luces traseras de niebla Feux anti-brouillard arrière Rear fog lights Luci fendinebbia posteriori Luzes de nevoeiro traseiras</p> 
<b>3</b>	<p>Luces de salpicadero Ampoule éclairage tableau de bord Dashboard lights Luci del cruscotto Luzes do painel</p> 	<b>10</b>	<p>Luces traseras de posición Feux de position arrière Tail lights Luci posteriori di posizione Luzes de presença traseiras (mínimos)</p> 	<b>14</b>	<p>Luces de frenado / Feux stop Brake lights / Luci di frenata Luzes do travão</p> 
<b>4</b>	<p>Luces intermitentes delanteras Feux clignotant avant Front indicator lights Luci direzionali Luzes de mudança de direção dianteiros (piscas)</p> 	<b>11</b>	<p>Luces de marcha atrás / Feux de recul Reversing lights / Luci retromarcia Luzes de marcha atrás</p> 		
<b>5</b>	<p>Luces de carretera - luz de cruce Feux de route - feux de croisement Headlights (full beam - low beam) Luci stradali - abbaglianti / anabbaglianti Luzes de cruzamento</p>  				
<b>6</b>	<p>Luces delanteras de posición Feux de position avant Parking lights Luci anteriori di posizione Luzes de presença dianteiras (mínimos)</p> 				
<b>7</b>	<p>Luces delanteras de niebla Feux anti-brouillard avant Front fog lights Fendinebbia anteriori Luzes de nevoeiro dianteiras</p> 				

	Ref	V	W		MODEL			
	<b>P-21</b>	<b>0350 2410</b>	24 V	21 W	1 POLO P21W (BA15s)	10	<b>0,53</b>	
	<b>P-21/5</b>	<b>0350 2420</b>	24 V	21/5 W	2 POLOS P21/5W (BA15d)	10	<b>0,53</b>	
	<b>T4W</b>	<b>0350 2423</b>	24 V	4 W	CONTROL T4W (BA9s)	10	<b>0,35</b>	
	<b>R10W</b>	<b>0350 2422</b>	24 V	10 W	PILOTO R10W (BA15s)	10	<b>0,42</b>	
	<b>R5W</b>	<b>0350 2421</b>	24 V	5 W	PILOTO R5W (BA15s)	10	<b>0,42</b>	
	<b>C10W</b>	<b>0350 2446</b>	24 V	10 W	PLAFONIER C10W	Ø11x31 mm	10	<b>0,35</b>
	<b>C5W</b>	<b>0350 2441</b>	24 V	5 W	PLAFONIER C5W	Ø11x38 mm	10	<b>0,37</b>
	<b>W1.2</b>	<b>0350 2431</b>	24 V	1.2 W	W1,2-T5 (W2x4,6d)		10	<b>0,35</b>
	<b>W-5</b>	<b>0350 2433</b>	24 V	5 W	W5W (W2,1x9,5d)		10	<b>0,35</b>
	<b>H-1</b>	<b>0350 2401</b>	24 V	70 W	<b>H1</b> (P14,5S) 70W		1	<b>3,20</b>
	<b>H-4</b>	<b>0350 2404</b>	24 V	75/70 W	<b>H4</b> (P43t) 75/70W		1	<b>5,86</b>
	<b>H-7</b>	<b>0350 2407</b>	24 V	70 W	<b>H7</b> (Px26d) 70W		1	<b>5,95</b>



LÁMPARA HALÓGENA / AMPOULE COFAN / COFAN BULB / LAMPADINA COFAN / LÂMPADA COFAN

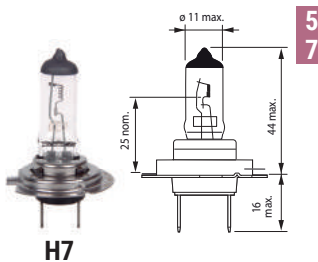
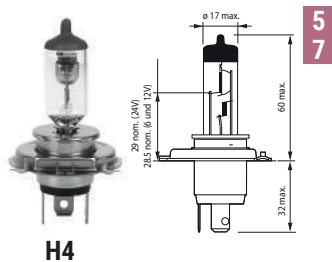
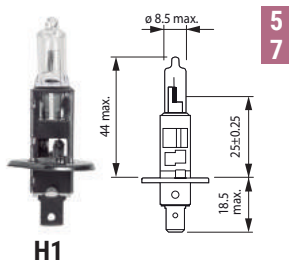

PACK 10 UDS LÁMPARA 2 POLOS / AMPOULE COFAN 2 PÔLES / DOUBLE POLE COFAN BULB / LAMPADINA COFAN 2 POLI / LÂMPADA COFAN 2 POLOS

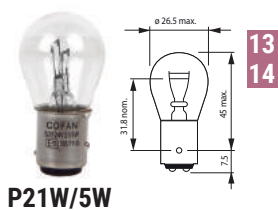
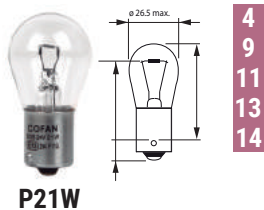

PACK 10 UDS LÁMPARA PILOTO / AMPOULE COFAN PILOTE / PILOT COFAN BULB / LAMPADINA COFAN PILOTA / LÂMPADA COFAN FAROLIM

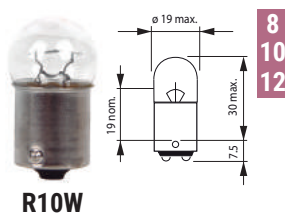
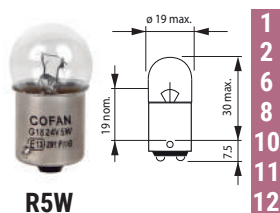

PACK 10 UDS LÁMPARA CONTROL / AMPOULE COFAN / COFAN BULB / LAMPADINA COFAN / LÂMPADA COFAN

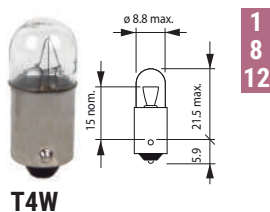

PACK 10 UDS LÁMPARA SIN CASQUILLO / AMPOULE SANS DOUILLE / BULB WITHOUT BULBHOLDER / LAMPADINA SENZA BASE / LÂMPADA SEM CASQUILHO

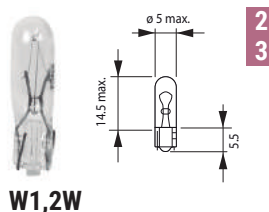
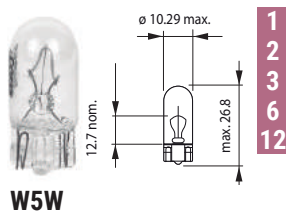

PACK 10 UDS LÁMPARA PLAFONIER / AMPOULE PLAFONIER / BULB PLAFONIER / LAMPADINA PLAFONIERA / LÂMPADA PLAFONIER

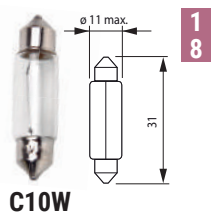
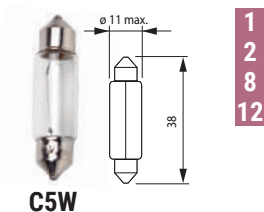

Las lámparas halógenas Cofan cumplen las normas europeas y garantizan una excelente calidad.  
 The cofan halogen lamps fulfill the European norms and guarantee an excellent quality.  
 Les lampes halogènes cofan répondent aux normes européennes et garantissent une excellente qualité.  
 As lâmpadas halógenas cofan cumprem as normas europeias e garantem uma qualidade excelente.  
 Le lampade dell'halogeno cofan compiono le norme europee e garantiscono una qualità eccellente.





	ES	FR	EN	IT	PT
<b>Ref</b>	Referencia	Référence	Reference	Riferimento	Referência
	Presión	Pression	Pressure	Pressione	Pressão
	Capacidad	Capacité	Capacity	Capacità	Capacidade
	Packing	Conditionnement	Packing	Imballo	Embalagem
	Precio	Prix	Price	Prezzo	Preço
	Diámetro	Diamètre	Diameter	Diametro	Diâmetro
	Material	Matériel	Material	Materiale	Material
	Rosca	Filetage	Thread	Rivettatura	Rosca entrada de ar PT
	Blíster	Blister	Blister	Blister	Blister
	Descripción	Description	Description	Descrizione	Descrição
	Longitud	Longueur	Length	Lunghezza	Comprimento
	Contenido	Contenu	Contents	Contenuto	Conteúdo
	Unidad mínima de venta	Nombre d'unités minimum de vente	Minimum sale unit	Quantitativo minimo di vendita	Unidade mínima de venda
	Diámetro broca	Diamètre vis	Diameter drill	Diámetro broca	Diámetro punta trapano
	Voltaje	Voltage	Voltage	Voltaggio	Voltagem
	Diámetro de la varilla	Diamètre de tige	Rod diameter	Diametro dello stelo pistone	Diámetro da haste
	Diámetro del cuerpo	Diamètre corps	Body diameter	Diametro del corpo	Diámetro do corpo
	Longitud del cuerpo	Longueur corps	Body length	Lunghezza del corpo	Comprimento do corpo
	Recorrido	Parcours	Stroke	Corsa	Circuito
	Color	Couleur	Color	Colore	Cores





●.cofan



[www.cofan.es](http://www.cofan.es)



# ÍNDICE / INDEX / CONTENTS

## INDICE / ÍNDICE



### 336

NORMATIVA / NORME / STANDARD  
STANDARD / NORMAS



### 344

GUANTES ANTIVIBRACIÓN / GANTS ANTI-VIBRATION  
ANTI-VIBRATION GLOVE / GUANTO ANTIVIBRAZIONE  
LUVAS ANTIVIBRAÇÃO



### 338

GUANTES DE PIEL / GANTS EN PEAU  
LEATHER GLOVES / GUANTI CUOIO  
LUVAS EM PELE



### 346

GUANTES IMPREGNADOS / GANTS IMPRÉGNÉS  
IMPREGNATED GLOVES / GUANTI IMPREGNATI  
LUVAS IMPREGNADAS



### 341

GUANTES AISLANTES / GANTS ISOLANTS  
INSULATING GLOVES / GUANTI ISOLANTI  
LUVAS ISOLANTES



### 349

GUANTES DE LÁTEX RUGOSO / GANTS LATEX  
LATEX COATED GLOVES / GUANTI IN LATTICE RUGOSO  
LUVAS DE LÁTEX ÁSPERAS



### 341

GUANTES DE NYLON Y ALGODÓN  
GANTS EN NYLON ET COTON  
NYLON AND COTTON GLOVES  
GUANTI DI NYLON E COTONE  
LUVAS DE NYLON E ALGODÃO



### 350

GUANTES DE LÁTEX / GANTS EN LATEX  
LATEX GLOVES / GUANTI IN LATEX  
LUVAS DE LÁTEX



### 342

GUANTE ANTICORTE / GANT ANTI-COUPURE  
CUT RESISTANT GLOVE / GUANTO ANTITAGLIO  
LUVAS ANTICORTE



### 351

GUANTES DE NEOPRENO Y NITRILLO  
GANTS EN NÉOPRÈNE ET NITRILE  
NEOPRENE AND NITRILE GLOVES  
GUANTI IN NEOPRENE E NITRILE  
LUVAS DE NEOPRENE E NITRILE





**351**

GUANTES DE PVC / GANTS EN PVC / LATEX PVC  
GUANTI IN PVC / LUVAS DE PVC



**363**

PROTECCIÓN RESPIRATORIA  
PROTECTION RESPIRATOIRE  
RESPIRATORY PROTECTION  
PROTEZIONE DELLE VIE RESPIRATORIE  
PROTEÇÃO RESPIRATÓRIA



**352**

GUANTES DESECHABLES / GANTS JETABLES  
DISPOSABLE GLOVES / GUANTI MONOUSO  
LUVAS DESCARTÁVEIS



**369**

PROTECCIÓN DE LA CABEZA  
PROTECTION DE LA TÊTE / HEAD PROTECTION  
PROTEZIONE PER LA TESTA / PROTEÇÃO DA CABEZA



**354**

GAFAS DE SEGURIDAD / LUNETTES DE SÉCURITÉ  
SAFETY GLASSES / OCCHIALI DI SICUREZZA  
ÓCULOS DE SEGURANÇA



**370**

PROTECCIÓN AUDITIVA / PROTECTION AUDITIVE  
EAR PROTECTION / PROTEZIONE DELL'UDITO  
PROTEÇÃO AUDITIVA



**359**

PROTECCIÓN DE LA VISTA / PROTECTION DES YEUX  
EYE PROTECTION / OCCHIALI PROTETTIVI  
PROTEÇÃO OCULAR



**371**

ARNESES ANTICAÍDAS / HARNAIS ANTI CHUTE  
SAFETY HARNESS / IMBRAGATURA ANTICADUTA  
ARNÊS ANTI-QUEDA



**361**

PROTECCIÓN PARA SOLDADURA  
PROTECTIONS POUR SOUDURE  
WELDING PROTECTION  
PROTEZIONE PER LA SALDATURA  
PROTEÇÃO PARA SOLDAGEM



**380**

PROTECCIÓN CORPORAL / PROTECTION CORPORELLE  
BODY PROTECTION / PROTEZIONE CORPO  
PROTEÇÃO CORPORAL

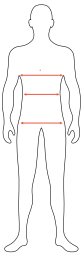

**381**

CLASIFICACIÓN DE TALLAS DE ROPA  
CLASSIFICATION DES TAILLES DE VÊTEMENT  
SIZES CLASSIFICATION  
CLASSIFICAZIONE DELLE TAGLIE DI ABBIGLIAMENTO  
CLASSIFICAÇÃO DE MEDIDAS DE ROUPA



**398**

CALZADO DE SEGURIDAD / CHAUSSURES DE SECURITE  
SAFETY FOOTWEAR / CALZATURE DI SICUREZZA  
CALÇADO DE SEGURANÇA



**382**

BUZO DE TRABAJO / BLEU DE TRAVAIL  
WORK OVERALL / TUTA DI PROTEZIONE DA LAVORO  
FATO MACACO DE TRABALHO



**412**

CALZADO DE TRABAJO / CHAUSSURES DE TRAVAIL  
WORKING FOOTWEAR / CALZATURE DA LAVORO  
CALÇADO LABORAL



**383**

ROPA ALTA VISIBILIDAD  
VETEMENTS HAUTE VISIBILITE  
HIGH VISIBILITY WORKWEAR  
GIUBBINI CATARIFRANGENTI  
ROUPA ALTA VISIBILIDADE



**416**

GLOSARIO / GLASSAIRE / GLOSSARY  
GLOSSARIO / GLOSSÁRIO



**383**

ROPA LABORAL / VÊTEMENT DE TRAVAIL  
WORKWEAR / ABITI DA LAVORO  
ROUPA DE TRABALHO



**396**





TRAJES DE AGUA / VÊTEMENTS DE PLUIE / RAINWEAR  
VESTITI IMPERMEABILI / FATOS DE ÁGUA



NORMATIVAS PARA LOS SIGUIENTES RIESGOS / NORMES POUR LES RISQUES SUIVANTS / EUROPEAN STANDARDS FOR THE FOLLOWING RISKS  
 NORMATIVE PER I SEGUENTI PERICOLI / NORMAS EUROPEIAS PARA OS SEGUINTES RICOS

<p><b>EN 388</b></p> 	<p>ES Riesgos mecánicos: Abrasión, corte, desgarro y perforación.                  FR Risques mécaniques: Abrasion, coupe, arrachement, perforation.                  EN Mechanical risks: Abrasion, cutting, tearing and perforation.                  IT Rischi meccanici: Abrasione, taglio, strappo e perforazione.                  PT Riscos mecânicos: Abrasão, corte, rasgo e perfuração.</p>
<p><b>EN 374</b></p> 	<p>ES Riesgos químicos: Resistencia frente a productos químicos. También adecuado contra microorganismos.                  FR Risques chimiques: Résistance aux produits chimiques. Egalement recommandés contre les micro-organismes.                  EN Chemical risks: Chemical products resistance. Suitable against microorganisms.                  IT Rischi chimici: Resistenza ai prodotti chimici. Adatto contro microorganismi.                  PT Riscos químicos: resistência frente a produtos químicos. Adequado também contra microorganismos.</p>
<p><b>EN 407</b></p> 	<p>ES Riesgos térmicos: Inflamables, calor por contacto, salpicaduras y grandes cantidades de metales fundidos.                  FR Risques thermiques: Produits inflammables, brûlure par contact, éclaboussures ou quantités importantes de métaux en cours de fonderie.                  EN Thermics risks: Flammable, heat by contact, splashing and big quantities of metals.                  IT Rischi termici: Infiammabilità, contatto con fonti di calore, schizzo e grandi quantità di metalli fusi.                  PT Riscos térmicos: Inflamáveis, calor por contato, respingos e grandes quantidades de metais fundidos.</p>
<p><b>EN 511</b></p> 	<p>ES Riesgos por frío: Por contacto, por convección y permeabilidad al agua.                  FR Risques par le froid/gel: Par contact, par convection et perméabilité de l'eau.                  EN Cold risks: By contact, convection and permeability to the water.                  IT Rischi da freddo: Per contatto, convezione e permeabilità all'acqua.                  PT Riscos por frio: por contato, por convecção e permeabilidade á água.</p>
<p><b>EN 14328</b></p> 	<p>ES Riesgos por corte.                  FR Risques de coupe.                  EN Cutting risks.                  IT Rischi per taglio.                  PT Riscos por corte.</p>
<p><b>EN 421</b></p> 	<p>ES Riesgos por radiaciones ionizantes y contaminación radiactiva.                  FR Risques par radiations ionisantes et pollution radioactive.                  EN Risks of radiation ionisation and radioactive radiation.                  IT Rischi da radiazioni ionizzanti e contaminazioni radioattive.                  PT Riscos de radiação ionizante e contaminação radioativa.</p>
<p><b>EN 374</b></p> 	<p>ES Riesgos por microorganismos.                  FR Risques par micro-organismes.                  EN Risks of microorganism.                  IT Rischi da microorganismi.                  PT Riscos de microorganismos.</p>
	<p>ES Compatibilidad alimenticia.                  FR Compatibilité alimentaire.                  EN Compatibility alimenticio.                  IT Per alimenti.                  PT Compatibilidade alimentar.</p>

RIESGOS MECÁNICOS / RISQUES MÉCANIQUES / MECHANICAL RISKS / RISCHI MECCANICI / RISCOS MECÂNICOS

<p><b>EN 388:2016</b></p>  <p><b>4 3 2 1 X</b></p>	<p>*4* (0 a 4)                  ES RESISTENCIA A LA ABRASIÓN - Número de ciclos necesarios para deterioro de la prenda.                  FR RESISTANCE A L'ABRASION - Nombre de cycles nécessaires pour détériorer le gant.                  EN ABRASION RESISTANCE - Necessary number of cycles to damage the glove.                  IT RESISTENZA ALL'ABRASIONE - Numero di cicli necessari per danneggiare il guanto.                  PT RESISTÊNCIA Á ABRASÃO - Número de ciclos necessários para a deterioração do vestuário.</p>
<p><b>EN 388:2016</b></p>  <p><b>4 3 2 1 X</b></p>	<p>*3* (0 a 5)                  ES RESISTENCIA AL CORTE POR CUCHILLA - Número de ciclos para cortar la prenda a cierta velocidad.                  FR RESISTANCE A LA COUPE PAR LAME - Nombre de cycles nécessaires pour couper le gant à une certaine vitesse.                  EN BLADE CUT RESISTANCE - Numbers of cycles to cut the glove at certain speed.                  IT RESISTENZA AL TAGLIO - Numero di cicli necessari per tagliare il guanto ad una determinata velocità.                  PT RESISTÊNCIA AO CORTE DE LÂMINAS - Número de ciclos para cortar a peça de vestuário a uma certa velocidade.</p>
<p><b>EN 388:2016</b></p>  <p><b>4 3 2 1 X</b></p>	<p>*2* (0 a 4)                  ES RESISTENCIA AL DESGARRO - Fuerza necesaria para desgarrar la prenda.                  FR RESISTANCE A L'ARRACHEMENT - Force nécessaire pour déchirer le gant.                  EN TEAR STRENGTH - Necessary strength to tear the glove.                  IT RESISTENZA ALLO STRAPPO - Forza necessaria per strappare il guanto.                  PT RESISTÊNCIA AO RASGO - Força necessária para rasgar a roupa.</p>
<p><b>EN 388:2016</b></p>  <p><b>4 3 2 1 X</b></p>	<p>*1* (0 a 4)                  ES RESISTENCIA A LA PERFORACIÓN - Fuerza necesaria para perforación de la prenda.                  FR RESISTANCE A LA PERFORATION - Force nécessaire pour la perforation du gant.                  EN PUNCTURE RESISTANCE - Necessary strength to perforate the glove.                  IT RESISTENZA ALLA PERFORAZIONE - Forza necessaria per perforare il guanto.                  PT RESISTÊNCIA Á PERFURAÇÃO - Força necessária para perfuração do vestuário.</p>
<p><b>EN 388:2016</b></p>  <p><b>4 3 2 1 X</b></p>	<p>*X* (0 a 4)                  ES RESISTENCIA AL CORTE.                  FR RESISTANCE A LA COUPE.                  EN CUT RESISTANCE.                  IT RESISTENZA AL TAGLIO.                  PT RESISTÊNCIA AO CORTE.</p>

---

 NORMATIVA EUROPEA / NORME EUROPEENNE / EUROPEAN STANDARD / STANDARD EUROPEI / NORMAS EUROPEÍAS
 

---

- ES Conforme a las exigencias del Reglamento (UE) 2016/425, cada producto de la marca "COFAN" está identificado claramente por su etiqueta normalizada.
- FR Conforme aux exigences de la Directive (UE) 2016/425 chaque produit de la marque "COFAN" est clairement identifié par son étiquette normalisée.
- EN Complying with the requirements of the Regulation (EU) 2016/425, all products under "COFAN" brand are appropriately marked by its standardised label.
- IT Soddisfa il Regolamento (UE) 2016/425, tutti nostri prodotti "COFAN" sono correttamente etichettati.
- PT Em conformidade com os requisitos do Regulamento (UE) 2016/425, todos os produtos da marca "COFAN" são adequadamente marcados pela sua etiqueta padronizada.

---

 CATEGORÍA 1 / CATEGORIE 1 / CATEGORY 1 / CATEGORIA 1 / CATEGORIA 1
 

---

- ES Superación de la norma EN 420 (mínimos a cumplir) eficacia contra riesgos mínimos. Efectos que pueden ser percibidos a tiempo por el usuario. Agresiones mecánicas superficiales. No afectan a partes vitales. Identificación - etiquetado - (fabricante) logo o NIF - referencia o modelo - talla - marcado CE. Estos guantes han de superar la EN 420 y se emite un autocertificado de conformidad con esa Norma. Declaración de conformidad del fabricante. Nº lote o serie.
- FR Dépassement de la norme EN 420 (réponse aux exigences minima) efficacité contre les risques minimum. Effets pouvant être perçus a temps par l'utilisateur. Aggressions mécaniques superficielles. N'affectent pas les parties vitales. Identification - étiquetage - (fabricant) logo ou siren - référence ou modèle - taille - marquage CE. Les gants concernés et qui dépassent les requêtes de la norme EN 420, sont de fait automatiquement certifiés conformes à cette norme.
- EN EN 420 standard (minimum requirements to fulfil) effectiveness against minimum risks. Effects that can be detected in time by user. Superficial mechanical aggressions. They do not affect vital parts. Identification - labeling - (manufacturer) logo or VAT number - reference or model - size - CE marked. These gloves must fulfil the requirements of EN 420 standard, and the company itself can issue a certificate.
- IT Standard EN 420 (requisiti minimi richiesti) - Efficacia contro i rischi minimi. Effetti che possono essere rilevati per tempo dall'utente. Aggressioni meccaniche superficiali. Non riguardano parti vitali. Identificazione - etichettatura - (fabbricante) logo o codice identificativo - riferimento o modello - taglia - marchio CE. Questi guanti devono soddisfare i requisiti indicati per essere certificati secondo lo standard EN 420, e la stessa società produttrice deve essere certificata.
- PT Norma EN 420 (requisitos mínimos a cumprir) eficácia contra riscos mínimos. Os efeitos podem ser detectadas no momento pelo utilizador. Agressões mecânicas superficiais. Não afetam partes vitais. Identificação - rotulagem - (fabricante) logo ou NIF - referência ou modelo - tamanho - CE marcado. Estas luvas devem cumprir os requisitos da norma EN 420, e a própria empresa pode emitir um certificado.

---

 CATEGORÍA 2 / CATEGORIE 2 / CATEGORY 2 / CATEGORIA 2 / CATEGORIA 2
 

---

- ES Superación norma EN 420 - (requisitos mínimos a cumplir) - eficacia contra riesgos de todo tipo que no causen lesiones muy graves o la muerte. Identificación - etiquetado - (fabricante) logo o NIF - pictograma del riesgo al que se recomienda - niveles de resistencia - referencia o modelo - talla - marcado CE. La norma EN 420 ha de ser hecha por un laboratorio notificado por la CE emitiendo un certificado CE tipo. Declaración de conformidad del fabricante. Nº lote o serie.
- FR Dépassement de la norme EN 420 - (réponse aux exigences minima) - efficacité contre les risques de tout type, qui ne provoquent pas de lésions trop graves ou danger mortel. Identification - étiquetage - (fabricant) logo ou siren - pictograma du risque contre lequel il est recommandé - niveaux de résistance - référence ou modèle - taille - marquage CE. La norme EN 420 doit être établie par un laboratoire certifié par la CE, avec émission d'un certificat CE type.
- EN EN 420 standard - (minimum requirements to fulfil) - effectiveness against all type of risks, except severe injuries or death. Identification - labeling - (manufacturer) logo or VAT number - pictogram of the risk what the item is recommended for - resistance levels - reference or model - size - CE marked. EN 420 standard must be made by a notified laboratory certified by CE, issuing a CE type certificate.
- IT Standard EN 420 - (requisiti minimi richiesti) - efficacia contro ogni tipo di rischio, eccetto quelli comportanti gravi ferite o morte. Identificazione - etichettatura - (fabbricante) logo o codice identificativo - pittogramma dei rischi per i quali l'oggetto è raccomandato - livelli di resistenza - codice o modello - taglia - marchio CE. Lo standard EN 420 deve essere assegnato da un laboratorio certificato CE, con il rilascio di un certificato di tipo CE.
- PT Norma EN 420 - (requisitos mínimos a cumprir) - eficácia contra riscos de todo o tipo que não provoquem lesões muito graves ou a morte. Identificação - rotulagem - (fabricante) logo ou NIF - pictograma de risco é recomendado - níveis de resistência - referência ou modelo - tamanho - CE marcado. A norma EN 420 deve ser feita por um laboratório notificado pela CE emitindo um certificado de tipo CE.

---

 CATEGORÍA 3 / CATEGORIE 3 / CATEGORY 3 / CATEGORIA 3 / CATEGORIA 3
 

---

- ES Guantes destinados a proteger frente a riesgos que causan lesiones muy graves o la muerte. Identificación - etiquetado - (fabricante) logo o NIF - pictograma del riesgo al que se recomienda - niveles de resistencia - referencia o modelo - talla - marcado CE. Deben ser certificados por un organismo notificado y auditados durante su fabricación. Declaración de conformidad del fabricante. Nº lote o serie.
- FR Gants destinés pour lutter contre les risques pouvant provoquer des lésions très graves ou danger mortel. Identification - étiquetage - (fabricant) logo ou siren - pictogramme du risque contre lequel il est recommandé - niveaux de résistance - référence ou modèle - taille - marquage CE. Doivent être certifiés par un organisme agréé, et avoir passé un audit de production.
- EN Gloves made to protect against risks causing severe injuries or death. Identification - labeling - (manufacturer) logo or VAT number - pictogram of the risk what the item is recommended for - resistance levels - reference or model - size - CE marked. They must be certified by a notified institution and audited during their production.
- IT Guanti concepiti per proteggere contro rischi che possono causare severe ferite o morte. Identificazione - etichettatura - (fabbricante) logo o codice identificativo - pittogramma dei rischi per i quali l'oggetto è raccomandato - livelli di resistenza - codice o modello - taglia - marchio CE. Questi guanti devono essere certificati da una istituzione riconosciuta e monitorati durante la loro produzione.
- PT Luvas concebidas para proteger contra os riscos que causam lesões graves ou morte. Identificação - rotulagem - (fabricante) logo ou NIF - pictograma de risco que é recomendado - níveis de resistência - referência ou modelo - tamanho - marcação CE. Devem ser certificados por um organismo notificado e auditados durante a sua fabricação.





GUANTE PIEL FLOR BRICOFAN / GANT DE CONDUCTEUR EN PEAU DE CHEVREAU / KID LEATHER DRIVER GLOVE  
GUANTO AUTISTA PELLE DI CAPRETTO / LUVAS MOTORISTA PELE CABRITO



EN388: 2016  
CAT II  
2121X

Ref				
1100 0159-8	12	120	4,20	
1100 0159-9	12	120	4,20	
1100 0159-10	12	120	4,20	

Ref				
1100 0159-8BL	12	120	4,40	✓
1100 0159-9BL	12	120	4,40	✓
1100 0159-10BL	12	120	4,40	✓

GUANTES PIEL DE VACUNO GRIS / GANTS EN PEAU GRIS / GREY COW LEATHER GLOVES  
GUANTI PIENO FIORE DI BOVINO GRIGI / LUVAS EM COURO CINZENTAS



EN388: 2016  
CAT II  
2122X

Ref				
1100 0091-7	12	120	4,50	
1100 0091-8	12	120	4,50	
1100 0091-9	12	120	4,50	
1100 0091-10	12	120	4,50	
1100 0091-11	12	120	4,50	

Ref				
1100 0091-7BL	12	120	4,85	✓
1100 0091-8BL	12	120	4,85	✓
1100 0091-9BL	12	120	4,85	✓
1100 0091-10BL	12	120	4,85	✓
1100 0091-11BL	12	120	4,85	✓

GUANTES PIEL DE VACUNO AMARILLO / GANTS EN PEAU JAUNE / YELLOW COW LEATHERS  
GUANTI PIENO FIORE DI BOVINO GIALLI / LUVAS EM COURO AMARELAS



EN388: 2016  
CAT II  
2122X

Ref				
1100 0088-7	12	120	5,58	
1100 0088-8	12	120	5,58	
1100 0088-9	12	120	5,58	
1100 0088-10	12	120	5,58	
1100 0088-11	12	120	5,58	

Ref				
1100 0088-7BL	12	120	5,85	✓
1100 0088-8BL	12	120	5,85	✓
1100 0088-9BL	12	120	5,85	✓
1100 0088-10BL	12	120	5,85	✓
1100 0088-11BL	12	120	5,85	✓

GUANTE VACUNO EXTRA CON BORREGUITO / GANTS EN CUIR VACHETTE / COW LEATHER GLOVE  
GUANTO NAPPA EXTRA C/IMBOTTITURA / LUVAS DE COURO EXTRA C/ FORRO ALGODAO



EN388: 2016  
CAT II  
2132X



Ref				
1100 0077-8	12	120	9,35	
1100 0077-9	12	120	9,35	
1100 0077-10	12	120	9,35	

Ref				
1100 0077-8BL	12	120	9,25	✓
1100 0077-9BL	12	120	9,25	✓
1100 0077-10BL	12	120	9,25	✓

GUANTES PIEL VACUNO "EXTRA" REPELENTE AL AGUA / GANT CUIR VACHETTE EXTRA HYDROFUGE  
COW GRAIN WATER RESISTANT LEATHER GLOVES / GUANTI GRIGI IDROREPELLENTI IN PELLE BOVINA  
LUVAS EM COURO "EXTRA" RESISTENTES Á ÁGUA



EN388: 2016  
CAT II  
2121X



Ref				
1100 0076-8	12	120	9,85	
1100 0076-9	12	120	9,85	
1100 0076-10	12	120	9,85	

Ref				
1100 0076-8BL	12	120	10,10	✓
1100 0076-9BL	12	120	10,10	✓
1100 0076-10BL	12	120	10,10	✓



GUANTES PIEL DE SERRAJE GRIS / GANTS CUIR SERRE GRIS / NATURAL SUEDE GLOVES  
GUANTO PELLE DE CHIUSURA GRIGIO / LUVAS EM PELE DE CAMURÇA



EN388: 2016  
CAT II  
3122X



Ref	📦	📦	📦	📦	Ref	📦	📦	📦	📦
1100 0099-9	12	120	3,90		1100 0099-9BL	12	120	4,15	✓
1100 0099-10	12	120	3,90		1100 0099-10BL	12	120	4,15	✓

GUANTES VACUNO DORSO TELA + VELCRO / GANT PEAU NATURELLE MIXTE + VELCRO / COW LEATHER GLOVE, LEATHER BACK + VELCRO  
GUANTO NAPPA DORSO TELA + VELCRO / LUVA DE COURO COM COSTAS EM TECIDO + VELCRO



EN388: 2016  
CAT II  
1122X



Ref	📦	📦	📦	📦	Ref	📦	📦	📦	📦
1100 0075-8	12	120	5,87		1100 0075-8BL	12	120	6,15	✓
1100 0075-9	12	120	5,87		1100 0075-9BL	12	120	6,15	✓
1100 0075-10	12	120	5,87		1100 0075-10BL	12	120	6,15	✓

GUANTES DE PIEL FLOR VACUNO Y DORSO TELA / GANTS EN PEAU DOS TOILE / LEATHER GLOVES WITH BACK SIDE OF HOSIERY FABRIC  
GUANTO BOVINO DORSO JERSEY / LUVAS DE COURO DE GRÃO COM COSTAS EM TECIDO



EN388: 2016  
CAT II  
2112X

Ref	📦	📦	📦	📦	Ref	📦	📦	📦	📦
1100 0156-6	12	120	4,40		1100 0156-6BL	12	120	4,65	✓
1100 0156-7	12	120	4,40		1100 0156-7BL	12	120	4,65	✓
1100 0156-8	12	120	4,40		1100 0156-8BL	12	120	4,65	✓
1100 0156-9	12	120	4,40		1100 0156-9BL	12	120	4,65	✓
1100 0156-10	12	120	4,40		1100 0156-10BL	12	120	4,65	✓

GUANTES DE PIEL FLOR VACUNO CON MANGUITO 13 CM DE SERRAJE / GANTS PEAU NATURELLE AVEC MANCHETTE DE 13 CM  
GLOVES MADE FROM COW GRAIN LEATHER WITH 13 CM LONG SLEEVE / GUANTI PIENO FIORE DI BOVINO CON POLSINO DI 13 CM  
LUVAS DE COURO DE GRÃO COM MANGA 13 CM DE CAMURÇA



EN388: 2016  
CAT II  
2121X

Ref	↔	📦	📦	📦	📦	Ref	↔	📦	📦	📦	📦
1100 0080-9	34 cm	12	60	9,15		1100 0080-9BL	34 cm	12	60	9,40	✓
1100 0080-10	34 cm	12	60	9,15		1100 0080-10BL	34 cm	12	60	9,40	✓

GUANTES SOLDADOR ROJO DE SERRAJE / GANT ROUGE EN PEAU / RED SUEDE GLOVES  
GUANTI ROSSI PER LA SALDATURA / LUVAS DE SOLDAGEM VERMELHAS



ES Talla Única. ES Forrado en el interior.  
FR Taille Unique. FR Fourrés à l'intérieur.  
EN One Size. EN Inside lining.  
IT Taglia Unica. IT Foderati all'interno.  
PT Tamanho Único. PT Forro interior.

EN388: 2016  
CAT II  
3233X

EN407: 2004  
CAT II  
413X4X

**COSTURAS KEVLAR**

TIPO A EN12477: 2001 + A12005  
CAT II

Ref	↔	📦	📦	📦	📦	Ref	↔	📦	📦	📦	📦
1100 0069	36 cm	6	60	7,10		1100 0069BL	36 cm	12	60	7,40	✓

GUANTES SERRAJE AMERICANO REFORZADOS EN PALMA, DEDO PULGAR E ÍNDICE / GANTS AMÉRICAINS POMME RENFORCÉE  
LEATHER WORKING GLOVES STRENGTHENED IN PALM AND THUMB / GUANTI DOCKER AMERICANI, RINFORZATI  
LUVAS DE CAMURÇA AMERICANAS REFORÇADAS NA PALMA E DEDO POLEGAR E INDICADOR



EN388: 2016  
CAT II  
2121X



Ref					Ref				
1100 0074	12	72	4,80		1100 0074BL	12	72	5,05	✓

GUANTE SERRAJE AMERICANO TALLA ÚNICA / GANTS CUIR AMERICAIN ECO. / LEATHER WORKING GLOVE "AMERICAN"  
GUANTO PELLE AMERICANO STANDARD / LUVA DE CAMURÇA AMERICANO T-UNICO



EN388: 2016  
CAT II  
2222X

Ref					Ref				
1100 0072	12	72	3,80		1100 0072BL	12	72	4,15	✓

GUANTES DE PIEL FLOR VACUNO REFORZADO / GANT PEAU PLEINE FLEUR RÉGLABLE RENFORCÉ / ADJUSTABLE AND REINFORCED GRAIN LEATHER GLOVE  
GUANTO DI PIENO FIORE REGOLABILE RINFORZATO / LUVA EM COURO AJUSTÁVEL REFORÇADO

EN388: 2016  
CAT II  
2133X



REFORZADO



PROTECCIÓN ARTERIAS  
ARTERIES PROTECTION

ES Recomendado para trabajos que requieren resistencia mecánica. Manejo de herramientas, construcción, industria, etc. Puño elástico con protector de arterias en cuero, todo piel flor vacuno, que proporciona una buena sujeción del guante durante la utilización junto con una protección incrementada.

FR Recommandé pour des travaux qui nécessitent une résistance mécanique. Manipulation d'outils, construction, industrie, etc. Poignée élastique avec protection des artères, en peau de vachette, ce qui permet une bonne prise en main du gant lors de son utilisation et une protection accrue.

EN It is recommended for jobs that require mechanical resistance. Handling of tools, construction, industry, etc. Expanded cuff with a leather artery protector all bovine flower leather, which provides a good grip on the glove during its use, along with an enhanced protection.

IT È raccomandato per lavori che richiedono resistenza meccanica. Il maneggio strumenti, costruzione, industria, ecc. Polsino elastico con protettore delle arterie tutto in pelle crosta di bovina, che fornisce una buona adesione sul guanto durante il suo impiego insieme a una migliore protezione.

PT Recomendado para trabalhos que requerem resistencia mecânica. Manejamento de ferramentas, construção, indústria, etc. Punho elástico com protetor de arterias em couro todo pel flor vaca, que proporciona uma boa sujeição da luva durante a utilização junto com uma proteção incrementada.

Ref				
1100 0230-8	10	100	6,30	
1100 0230-9	10	100	6,30	
1100 0230-10	10	100	6,30	
1100 0230-11	10	100	6,30	

Ref				
1100 0230-8BL	12	100	6,55	✓
1100 0230-9BL	12	100	6,55	✓
1100 0230-10BL	12	100	6,55	✓
1100 0230-11BL	12	100	6,55	✓





GUANTES AISLANTES / GANTS ISOLANTS / INSULATING GLOVES / GUANTI ISOLANTI / LUVAS ISOLANTES



CEI 60903:2002



Consultar disponibilidad y plazos de entrega.  
Consulter disponibilité et délais de livraison.  
Please, check availability and delivery time.  
Consultare per disponibilità e previsioni di consegna.  
Consultar disponibilidade e prazos de entrega.

Resistente a /Resistance à /Resistant to /Resistente a /Resistentes a:

A	Ácido / Acide / Acid / Acido / Ácido
Z	Ozono / Ozone / Ozone / Ozono / Ozono
H	Aceite / Huile / Oil / Olio / Óleo
	Muy baja temperatura / Très basse température
C	Extremely low temperature / Temperatura molto basse
	Temperaturas extremamente baixas

ES Guantes aislantes para alta tensión de 500, 1.000, 7.500, 17.000 y 26.500V. INSPECCIÓN - Antes de cada uso, llevar a cabo una inspección visual y comprobar el guante inflándolo para detectar posibles daños. Cualquier punción o perforación lo hace inutilizable.  
FR INSPECTION - Avant chaque utilisation, réalisez une inspection visuelle et testez le gant en le gonflant afin de détecter d'éventuels dommages. Toute ponction ou perforation rend le gant inutilisable.  
EN Insulating gloves for high voltage - 500, 1000, 7500, 17000 and 26500V. INSPECTION - Before each use, make a visual inspection and inflate the glove to detect possible damages. Any hole or perforation make it useless.  
IT ISPEZIONE - Prima di qualsiasi utilizzo, verificare sia con un'ispezione visiva che tattile in modo da escludere qualsiasi difetto o perforazione che li renderebbero inutilizzabili.  
PT INSPEÇÃO - Antes de cada uso, faça uma inspeção visual e encha a luva para detectar possíveis danos. Qualquer orifício ou perfuração as torna inúteis.

Ref	⚡	↔	RES	CAT	👤	📦	📊
1100 0281-9	500V	360 mm	AZC	00	9	1	84,86
1100 0281-10	500V		AZC	00	10	1	84,86
1100 0282-9	1.000V		AZC	0	9	1	99,41
1100 0282-10	1.000V		AZC	0	10	1	99,41
1100 0283-9	7.500V		AZC	1	9	1	122,90
1100 0283-10	7.500V		AZC	1	10	1	122,90
1100 0284-9	17.000V		AZHC	2	9	1	149,15
1100 0284-10	17.000V		AZHC	2	10	1	149,15
1100 0285-9	26.500V		AZHC	3	9	1	211,26
1100 0285-10	26.500V		AZHC	3	10	1	206,10

GUANTES DE NYLON Y ALGODÓN / GANTS EN NYLON ET COTON / NYLON AND COTTON GLOVES  
GUANTI DI NYLON E COTONE / LUVAS DE NYLON E ALGODÃO

GUANTES DE NYLON CON PUNTOS DE PVC / GANTS NYLON, POINTS EN PVC / NYLON GLOVES WITH PVC DOTS  
GUANTI IN NYLON CON PUNTI IN PVC / LUVAS DE NYLON COM PONTOS DE PVC



EN388: 2016  
CAT II  
1141X

ES Guante nylon, con puntos de PVC en palma y dedos. Gran adherencia para actividades agrícolas, recogida de frutas, etc.  
FR Gants nylon, points en PVC paume et des doigts. Grand adhérence pour l'agriculture, la cueillette des fruits, etc.  
EN Nylon gloves with PVC dots on palm and fingers. Grand adhesion for farming, fruit picking, etc.  
IT Guanto in nylon con punti in PVC sul palmo e le dita. Ottima aderenza, adatto per l'agricoltura, la raccolta della frutta, ecc.  
PT Luvas de nylon com pontos de PVC na palma e dedos. Grande aderência para a agricultura, colheita de frutas, etc.

Ref	📦	📦	📊	📦	Ref	📦	📦	📊	📦
1100 0079-7	12	120	1,75		1100 0079-7BL	12	120	1,90	✓
1100 0079-8	12	120	1,75		1100 0079-8BL	12	120	1,90	✓
1100 0079-9	12	120	1,75		1100 0079-9BL	12	120	1,90	✓
1100 0079-10	12	120	1,75		1100 0079-10BL	12	120	1,90	✓

GUANTES DE PUNTO DE ALGODÓN CON PUNTOS DE PVC / GANTS EN COTON ET PICOTS PVC / KNITTED COTTON GLOVES WITH PVC DOTS  
GUANTI IN COTONE CON PUNTI IN PVC / LUVAS EM MALHA DE ALGODÃO COM PONTOS DE PVC



EN388: 2016  
CAT II  
0120X

Ref	📦	📦	📊	📦	Ref	📦	📦	📊	📦
1100 0048	12	300	0,97		1100 0048BL	12	300	1,32	✓

GUANTES DE PUNTO EN ALGODÓN - PUÑO ELÁSTICO / GANTS EN COTON - POIGNÉE ÉLASTIQUE / KNITTED COTTON GLOVES - ELASTIC FIST  
GUANTI IN MAGLIA DI COTONE / LUVAS EM MALHA DE ALGODÃO - PUNHO ELÁSTICO



Ref	📦	📦	📊	📦	Ref	📦	📦	📊	📦
1100 0047	12	300	0,83		1100 0047BL	12	300	1,18	✓



GUANTE ANTICORTE HIGH TENACITY / GANT ANTI-COUPURE GRANDE RESISTANCE / CUT RESISTANT GLOVE, HIGH TENACITY  
GUANTO ANTITAGLIO, ALTA TENACITÀ / LUVAS ANTICORTE HIGH TENACITY

**RESISTENTE AL CORTE  
CUT RESISTANT**



 **EN388: 2016  
CAT II**  
3 5 4 X C



ES Máxima resistencia al corte por cuchilla. Alto nivel de resistencia a la abrasión. Galga 10.





FR Résistance maximum à la coupe par lame. Haut niveau de résistance à l'abrasion. Indice 10.

EN High level of blade cut resistance. Maximum resistance to abrasion. Gauge 10.





IT Massima resistenza al taglio della lama. Alto livello di resistenza all'abrasione. Calibro 10.

PT Excelente resistência ao corte por lâmina. Excelente resistência à abrasão. Calibre 10.

**Fibra de alta tenacidad  
High tenacity fibre**

Ref				
<b>1100 0233-8</b>	12	120	<b>8,20</b>	
<b>1100 0233-9</b>	12	120	<b>8,20</b>	
<b>1100 0233-10</b>	12	120	<b>8,20</b>	

Ref				
<b>1100 0233-8BL</b>	12	120	<b>8,45</b>	✓
<b>1100 0233-9BL</b>	12	120	<b>8,45</b>	✓
<b>1100 0233-10BL</b>	12	120	<b>8,45</b>	✓

GUANTE ANTICORTE HIGH TENACITY CON REFUERZO / GANT ANTI-COUPURE GRANDE RESISTANCE (REFORCÉ)  
REINFORCED CUT RESISTANT GLOVE (HIGH TENACITY) / GUANTO ANTITAGLIO ALTA TENACITÀ (RIFORZATO) / LUVAS ANTICORTE (HIGH TENACITY) REFORÇADAS

**RESISTENTE AL CORTE  
CUT RESISTANT**



 **EN388: 2016  
CAT II**  
4 5 4 4 D



ES Máxima resistencia al corte por cuchilla. Alto nivel de resistencia a la abrasión. Galga 10. Ideal para trabajos pesados. Piel de vacuno sobre palma y dedos.



FR Résistance maximum à la coupe par lame. Haut niveau de résistance à l'abrasion. Indice 10. Idéal pour travaux lourds. Daim sur la paume et doigts.

EN High level of blade cut resistance. Maximum resistance to abrasion. Gauge 10. Ideal for heavy works. Cow leather on palm and fingers.

IT Massima resistenza al taglio della lama. Alto livello di resistenza all'abrasione. Calibro 10. Ideale per lavori gravosi. Pelle bovina su palmo e dita

PT Excelente resistência ao corte por lâmina. Excelente resistência à abrasão. Calibre 10. Ideal para trabalhos pesados. Couro bovino na palma e dedos.

**Fibra de alta tenacidad  
High tenacity fibre**

Ref			
<b>1100 0237-9</b>	1	10	<b>16,45</b>
<b>1100 0237-10</b>	1	10	<b>16,45</b>





GUANTE ANTICORTE Y ANTICALÓRICO / GANT ANTI-COUPURE ET ANTI CHALEUR / HEAT AND CUT RESISTANT GLOVE  
GUANTO ANTITAGLIO E ANTICALORE CON MANICA / LUVA ANTICORTE E ANTICALÓRICA

**RESISTENTE AL CORTE  
CUT RESISTANT**



EN388: 2016  
CAT II  
244XD

EN407: 2004  
CAT II  
43313X



**100% Para-aramid**

Ref			
<b>1100 0231</b>	1	6	<b>19,95</b>

GUANTE ANTICORTE Y ANTICALÓRICO CON MANGUITO / GANT ANTI-COUPURE ET ANTI CHALEUR LONG 15 CM  
HEAT AND CUT RESISTANT GLOVE WITH 15CM SLEEVE / GUANTO ANTITAGLIO E ANTICALORE CON MANICA 15CM  
LUVA ANTICORTE E ANTICALÓRICA COM PUNHO 15CM

**RESISTENTE AL CORTE  
CUT RESISTANT**



EN388: 2016  
CAT II  
244XD

EN407: 2004  
CAT II  
43313X



**100% Para-aramid**

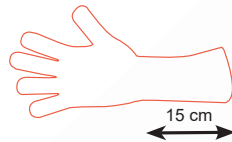

Ref			
<b>1100 0232</b>	1	6	<b>23,95</b>

GUANTE ANTICORTE CON REFUERZO / GANT ANTI-COUPURE 35CM REFORCÉ / 35 CM REINFORCED CUT RESISTANT GLOVE  
GUANTO ANTITAGLIO 35CM RIFORZATO / LUVAS ANTICORTE 35CM REFORÇADAS

**RESISTENTE AL CORTE  
CUT RESISTANT**



EN388: 2016  
CAT II  
4343X



**Mix para-aramid/polyamide  
Hilo: Kevlar/Twaron**

Ref			
<b>1100 0236</b>	1	6	<b>18,25</b>



**GUANTES ANTIVIBRACIÓN / GANTS ANTI-VIBRATION / ANTI-VIBRATION GLOVE  
GUANTO ANTIVIBRAZIONE / LUVA ANTIVIBRAÇÃO**



GUANTE ANTICORTE Y ANTIVIBRACIÓN MOD. OMNIPOTENT / GANT ANTICOUURE ET ANTI-VIBRATION MOD. OMNIPOTENT  
CUT RESISTANT ANTI-VIBRATION GLOVE MOD. OMNIPOTENT / GUANTO ANTITAGLIO E ANTIVIBRAZIONE MOD. OMNIPOTENT  
LUVA ANTICORTE E ANTIVIBRAÇÃO MOD. OMNIPOTENT



**EN 388:2016**



**A B C D E F  
4 4 4 3 C P**

<b>A</b>	RESISTENCIA A LA ABRASIÓN (Ciclos)	
	NIVEL	1 2 3 ④ 5
	CICLOS	10 25 50 75 -

El test de abrasión se realiza ahora con un nuevo papel de lija de calidad más consistente que el papel utilizado con anterioridad.

<b>B</b>	RESISTENCIA AL CORTE POR CUCHILLA (Índice)	
	NIVEL	1 2 3 ④ 5
	ÍNDICE	1,2 2,5 5 10 20

<b>C</b>	RESISTENCIA AL RASGADO (Newtons)	
	NIVEL	1 2 3 ④ 5
	NEWTONS	10 25 50 75 -

<b>D</b>	RESISTENCIA A LA PERFORACIÓN (Newtons)	
	NIVEL	1 2 ③ 4 5
	NEWTONS	20 60 100 150 -

<b>E</b>	Nuevo método de ensayo	
	RESISTENCIA AL CORTE EN ISO 13997	
	NIVEL	A B ③ D E F
NEWTONS	2 5 10 15 22 30	

En caso de que en el ensayo de resistencia al corte (B) se produzca el embotamiento de las cuchillas por el material, se realizará la prueba de resistencia al corte EN ISO 13997 (E) que dará como resultado un nivel de rendimiento con una letra de la A a la F.

<b>F</b>	Nuevo método de ensayo (opcional)	
	PROTECCIÓN CONTRA IMPACTOS	
	EN 13594:2015	
SUPERADO O FALLIDO		

Nuevo ensayo que permite determinar el comportamiento de un guante contra los impactos. En caso de que el guante se someta a 1 test (opcional), se añadiría la letra P después de los cinco primeros niveles en caso de superarlo.

La letra X significa que no se ha realizado el test o bien que no es aplicable.

- ES **Antimpactos.**
- FR **Anti-impacts.**
- EN **Anti-impacts.**
- IT **Anti impatto.**
- PT **Anti-impactos.**
- ES **Antivibración.**
- FR **Antivibration.**
- EN **Anti-vibration.**
- IT **Antivibrazione.**
- PT **Anti-vibração.**

- ES - Doble recubrimiento para extra químico, aceite resistente a la abrasión.
- Supera en calidad a las opciones en piel.
  - Acabado en nitrilo arenoso antideslizante.
  - Palma acolchada resistente a las vibraciones.
  - Dedos reforzados en la parte posterior de la mano resistentes al impacto.
  - Zonas de alta visibilidad con tejido que proporciona seguridad y transpirabilidad.
  - Zona del pulgar reforzada y antideslizante con material DUPONT'S KEVLAR con excelente DURABILIDAD.

- FR - Double revêtement pour une meilleure résistance aux produits chimiques, à l'huile et à l'abrasion.
- Surpasse les options du cuir en qualité.
  - Finition nitrile sable antidérapante.
  - Paume rembourrée résistante aux vibrations.
  - Doigts renforcés et résistants aux chocs sur le dos de la main.
  - Zones de haute visibilité avec un tissu qui assure la sécurité et la respirabilité.
  - Zone de pouce renforcée et antidérapante avec le matériau DUPONT'S KEVLAR doté d'une excellente DURABILITÉ.

- EN - Double covering for chemical purposes, high resistant to abrasion.
- It surpasses the quality of other leather gloves.
  - Slip-resistant sand finished nitrile.
  - Vibration resistant padded palm.
  - Reinforced finger overlays resistant to impacts.
  - High visibility areas with fabric that provides safety and breathability.
  - Reinforced slip-resistant thumb fitted with DUPONT'S KEVLAR material that provides an excellent DURABILITY.

- IT - Doppio prodotto coprente per uso chimico, elevata resistenza all'abrasione.
- Supera la qualità d'altri guanti in pelle.
  - Finitura in nitrile sabbato antiscivolo.
  - Palmo imbottito resistente alla vibrazioni.
  - Dita rinforzati al dorso resistenti alla vibrazioni.
  - Aree ad alta visibilità con tessuto che forniscono della sicurezza e traspirabilità.
  - Pollice rinforzato e resistente di slittamento con materiale DUPONT'S KEVLAR che fornisce una durata eccellente.

- PT - Revestimento duplo para uso químico extra resistente à abrasão.
- Supera em qualidade as opções em pele.
  - Acabamento em nitrilo arenoso antideslizante.
  - Palmar acolchoado resistente às vibrações.
  - Dedos reforçados na parte posterior da mão, resistentes ao impacto.
  - Zonas de alta visibilidade com tecido que proporciona segurança e transpirabilidade.
  - Zona do pulgar reforçada anti deslizante com material DUPONT'S KEVLAR com excelente DURABILIDADE.

Ref					
<b>1100 0266 - M</b>	8	1	6	<b>26,15</b>	✓
<b>1100 0266 - L</b>	9	1	6	<b>26,15</b>	✓
<b>1100 0266 - XL</b>	10	1	6	<b>26,15</b>	✓



GUANTE ANTIVIBRACIÓN MOD. GEL PROTECT / GANT ANTI-VIBRATION MOD. GEL PROTECT / ANTI-VIBRATION GLOVE MOD. GEL PROTECT  
GUANTO ANTIVIBRAZIONE MOD. GEL PROTECT / LUVA ANTIVIBRAÇÃO MOD. GEL PROTECT

EN388: 2016  
CAT II  
2121 X



Reflective / Reflectante

- ES **Antivibración.**
- FR **Antivibration.**
- EN **Anti-vibration.**
- IT **Antivibrazione.**
- PT **Anti-vibração.**

ES Indicado para trabajos donde exista un riesgo mecánico para la palma de la mano: construcción, siderurgia, automoción, metalurgias, carga y descarga, agricultura...

FR Indiqué pour les travaux où il y a un risque mécanique pour la paume de la main : construction, acier, automobile, métallurgie, chargement et déchargement, agriculture...

EN It is suitable for works in which there are mechanical hazards for the palm in building, steel, automotive, metal sectors, loading or unloading, agriculture...

IT È adatto alle lavori dove ci sono pericoli meccanici per il palmo della mano in settori come il automobilistico, della costruzione, siderurgia, metallurgia, caricamento e scaricamento, agricoltura...

PT Adequado para trabalhos onde existe um risco mecânico para a palma da mão: construção, aço, automotivo, metalurgia, carga e descarga, agricultura ...



Ref					
1100 0265 - M	8	1	6	17,39	✓
1100 0265 - L	9	1	6	17,39	✓
1100 0265 - XL	10	1	6	17,39	✓

GUANTE ANTIVIBRACIÓN FOAM MOD. UTILITY / GANT ANTI VIBRATION MOUSSE MOD. UTILITY / ANTI-VIBRATION GLOVE MOD. UTILITY  
GUANTO ANTIVIBRAZIONE SCHIUMA MOD. UTILITY / LUVA ANTIVIBRAÇÃO FOAM MOD. UTILITY

EN388: 2016  
CAT II  
2121 X



Reflective / Reflectante

- ES **Antivibración.**
- FR **Antivibration.**
- EN **Anti-vibration.**
- IT **Antivibrazione.**
- PT **Anti-vibração.**

ES Indicado para trabajos donde exista un riesgo mecánico para la palma de la mano: construcción, siderurgia, automoción, metalurgias, carga y descarga, agricultura...

FR Indiqué pour les travaux où il y a un risque mécanique pour la paume de la main : construction, acier, automobile, métallurgie, chargement et déchargement, agriculture...

EN It is suitable for works in which there are mechanical hazards for the palm in building, steel, automotive, metal sectors, loading or unloading, agriculture...

IT È adatto alle lavori dove ci sono pericoli meccanici per il palmo della mano in settori come della costruzione, automobilistico, siderurgia, metallurgia, caricamento e scaricamento, agricoltura...

PT Adequado para trabalhos onde existe um risco mecânico para a palma da mão: construção, aço, automotivo, metalurgia, carga e descarga, agricultura, ...



Ref					
1100 0267 - M	8	1	6	19,23	✓
1100 0267 - L	9	1	6	19,23	✓
1100 0267 - XL	10	1	6	19,23	✓



**GUANTES DE NITRILO / GANTS EN NITRILE / NITRILE COATED GLOVES / GUANTI IN NITRILE / LUVAS DE NITRILO**

Naranja / Orange / Orange / Arancione / Laranja



ES Guantes de nitrilo. Revestimiento no absorbente, anticorte, elevada resistencia.  
FR Gants en nitrile. Anti-coupe, revêtement anti-absorbant, très résistant.  
EN Nitrile coated work gloves, knit wrist. Non-absorbent coating, anticutting, high resistance.  
IT Guanto in nitrile con polsino elastico. Antitaglio, rivestimento antiassorbimento, molto resistente.  
PT Luvas de nitrila. Revestimento não absorvente, anti-corte, resistência elevada.

Ref					Ref				
<b>1100 0094-8</b>	12	120	<b>1,85</b>		<b>1100 0094-8BL</b>	12	120	<b>2,18</b>	✓
<b>1100 0094-9</b>	12	120	<b>1,85</b>		<b>1100 0094-9BL</b>	12	120	<b>2,18</b>	✓
<b>1100 0094-10</b>	12	120	<b>1,85</b>		<b>1100 0094-10BL</b>	12	120	<b>2,18</b>	✓

Azul / Blue / Blue / Blu / Azul



ES Guantes de nitrilo. Revestimiento no absorbente, anticorte, elevada resistencia.  
FR Gants en nitrile. Anti-coupe, revêtement anti-absorbant, très résistant.  
EN Nitrile coated work gloves, knit wrist. Non-absorbent coating, anticutting, high resistance.  
IT Guanto in nitrile con polsino elastico. Antitaglio, rivestimento antiassorbimento, molto resistente.  
PT Luvas de nitrila. Revestimento não absorvente, anti-corte, resistência elevada.

Ref					Ref				
<b>1100 0097-8</b>	12	120	<b>2,93</b>		<b>11000097-8BL</b>	12	120	<b>3,26</b>	✓
<b>1100 0097-9</b>	12	120	<b>2,93</b>		<b>11000097-9BL</b>	12	120	<b>3,26</b>	✓
<b>1100 0097-10</b>	12	120	<b>2,93</b>		<b>11000097-10BL</b>	12	120	<b>3,26</b>	✓

Azul - Tipo Americano / Bleu - Typo Américain  
Blue - Open Wrist Type / Azzurro - Tipo Americano  
Azul - Tipo Americano



ES Guantes de nitrilo. Revestimiento no absorbente, anticorte, elevada resistencia.  
FR Gants en nitrile. Anti-coupe, revêtement anti-absorbant, très résistant.  
EN Nitrile coated work gloves, knit wrist. Non-absorbent coating, anticutting, high resistance.  
IT Guanto in nitrile con polsino elastico. Antitaglio, rivestimento antiassorbimento, molto resistente.  
PT Luvas de nitrila. Revestimento não absorvente, anti-corte, resistência elevada.

Ref					Ref				
<b>1100 0007-8</b>	12	120	<b>3,45</b>		<b>1100 0007-8BL</b>	12	120	<b>3,80</b>	✓
<b>1100 0007-9</b>	12	120	<b>3,45</b>		<b>1100 0007-9BL</b>	12	120	<b>3,80</b>	✓
<b>1100 0007-10</b>	12	120	<b>3,45</b>		<b>1100 0007-10BL</b>	12	120	<b>3,80</b>	✓

**GUANTE IMPREG. NITRILO ESPUMA PROTECC. FRÍO / GANT IMPREG. NITRILE MOUSSE PROTECT. FROID  
SANDY NITRILE 3/4 COATED DOUBLE LAYER WINTER GLOVE / GUANTO IMPREGNATO IN NITRILE, SCHIUMA PROTEZ. FREDDO  
LUVAS IMPREG. NITRILO ESPUMA PROTECC. FRIIO**



**ALTA RESISTENCIA AL FRÍO  
HIGH RESISTANCE WI**

ES Automoción, construcción, manipulación de aceites o grasas.  
FR Entretien mécanique, construction, manipulation d'huiles ou de matières grasses.  
EN Automotive and building industry, oil and grease manipulation.  
IT Automazione, costruzioni, utilizzo di oli o grassi.  
PT Automotivo, construção, naipulação de óleos ou lubrificantes.

Ref				
<b>1100 0276-8</b>	12	120	<b>7,52</b>	✓
<b>1100 0276-9</b>	12	120	<b>7,52</b>	✓
<b>1100 0276-10</b>	12	120	<b>7,52</b>	✓





GUANTE IMPREG. NITRILLO COMPLETO FOAM NITRILLO / GANT IMPREG.COMPLET FOAM NITRILE / FULLY DIPPED FOAM NITRILE COATED GLOVE  
GUANTO IMPREGNATO IN NITRILE, SCHIUMA / LUVAS IMPREG.COMPLETO FOAM NITRILLO



EN388: 2016  
CAT II  
4031X

**100% IMPREGNADOS  
FULLY COATED**

Ref	Grid	Box	Roll	Truck
1100 0273-7	12	120	4,60	✓
1100 0273-8	12	120	4,60	✓
1100 0273-9	12	120	4,60	✓
1100 0273-10	12	120	4,60	✓
1100 0273-11	12	120	4,60	✓

ES Automoción, construcción, manipulación de aceites o grasas.  
FR Entretien mécanique, construction, manipulation d'huiles ou de matières grasses.  
EN Automotive and building industry, oil and grease manipulation.  
IT Automazione, costruzioni, utilizzo di oli o grassi.  
PT Automotivo, construção, manipulação de óleos ou lubrificantes.

GUANTE IMPREGNADO NITRILLO ROJO/NEGRO / GANT IMPREGNE ROUGE/NOIR / PALM-DIPPED NITRILE COATED GLOVE RED/BLACK  
GUANTO IMPREGNATO, SCHIUMA, ROSSO/NERO / LUVAS IMPREGNADAS VERMELHO/PRETO



EN388: 2016  
CAT II  
4131X

**SANDY  
COATING**

ES Automoción, construcción, manipulación de aceites o grasas.  
FR Entretien mécanique, construction, manipulation d'huiles ou de matières grasses.  
EN Automotive and building industry, oil and grease manipulation.  
IT Automazione, costruzioni, utilizzo di oli o grassi.  
PT Automotivo, construção, manipulação de óleos ou lubrificantes.

Ref	Grid	Box	Roll	Truck
1100 0274-6	12	120	3,38	✓
1100 0274-7	12	120	3,38	✓
1100 0274-8	12	120	3,38	✓
1100 0274-9	12	120	3,38	✓
1100 0274-10	12	120	3,38	✓
1100 0274-11	12	120	3,38	✓

GUANTE ANTICORTE IMPREGNADO PU GRIS / GANTS ANTI-COUPURE IMPRÉGNÉS PU GRIS / CUT RESISTANT PU COATED GREY GLOVES  
GUANTO SPALMATO IN PU GRIGIO ANTITAGLIO / LUVA ANTI-CORTE IMPREGNADA DE PU CINZA

**RESISTENTE AL CORTE  
CUT RESISTANT**

EN388: 2016  
CAT II  
4543F



ES Fibra anticorte de altas prestaciones impregnado de poliuretano. Protección, destreza, ligereza y sensación de tacto en un guante de gran nivel anticorte. Apto para aeronáutica, automoción, construcción, etc.  
FR Fibre anti-coupure haute performance imprégnée de polyuréthane. Protection, dextérité, légèreté et sensation de toucher dans un gant anti-coupure de haut niveau. Convient pour l'aéronautique, l'automobile, la construction, etc.  
EN Cut resistant high-performance fiber impregnated in polyurethane. These high cut resistant gloves offer protection, lightness, skill, as well as a good touch sensibility. Suitable for aeronautical, automotive, construction industries, etc.  
IT Fibra antitaglio ad alta prestazione impregnato in poliuretano. Questi guanti offrono della protezione, destrezza, leggerezza e buona sensibilità al tocco. Adatto per gli settori della industria aeronautica, automobilistica, l'edilizia, ecc.  
PT Fibra anti-corte de altas prestações impregnado de poliuretano. Proteção, destreza, ligeireza e sensação de tacto numa luva de grande nível anti-corte. Apto para aeronáutica, automação, construção, etc.

Ref	Grid	Box	Roll	Truck
1100 0277-7	12	120	6,20	✓
1100 0277-8	12	120	6,20	✓
1100 0277-9	12	120	6,20	✓
1100 0277-10	12	120	6,20	✓
1100 0277-11	12	120	6,20	✓

GUANTE SOPORTE POLIÉSTER IMPREGNADO LATEX NEGRO / GANT POLYESTER IMPRÉGNÉ LATEX NOIR / POLYESTER GLOVE BLACK LATEX COATING  
GUANTO POLIESTERE IMPREGNATO LATTICE NERO / LUVA POLIÉSTER IMPREGNADA LATEX PRETA



EN388: 2016  
CAT II  
3131X

ES Apto para automoción, construcción, manipulación de aceites o grasas.  
FR Convient pour l'automobile, la construction, la manipulation d'huiles ou de graisses.  
EN Suitable for building and automotive sectors and for handling materials with oil or grease.  
IT Adatto per i settori della automobilistico, dell'edilizia e per il maneggio di materiali coperti di grasso o olio.  
PT Apto para auto, construção, manipulação de óleos e gorduras.

Ref	Grid	Box	Roll	Truck
1100 0278-7	12	120	2,10	✓
1100 0278-8	12	120	2,10	✓
1100 0278-9	12	120	2,10	✓
1100 0278-10	12	120	2,10	✓





GUANTES IMPREGNADOS, TEJIDO DE PUNTO DE POLIÉSTER RECUBIERTO / GANTS EN POLYESTER IMPREGNE / POLYESTER GLOVES IMPREGNATED  
GUANTI DI POLIESTERE IMPREGNATO / LUVAS DE POLIÉSTER IMPREGNADAS

**Poliuretano / Pu**

Negro / Noir / Black / Nero / Pretas



EN388: 2016  
CAT II  
1121X

Ref				
1100 0125-6	12	144	1,22	
1100 0125-7	12	144	1,22	
1100 0125-8	12	144	1,22	
1100 0125-9	12	144	1,22	
1100 0125-10	12	144	1,22	
1100 0125-11	12	144	1,22	

Ref				
1100 0125-6BL	12	144	1,47	✓
1100 0125-7BL	12	144	1,47	✓
1100 0125-8BL	12	144	1,47	✓
1100 0125-9BL	12	144	1,47	✓
1100 0125-10BL	12	144	1,47	✓
1100 0125-11BL	12	144	1,47	✓

**Nitrilo**

Gris-Blanco / Gris-Blanc / Grey-White  
Grigio-Bianco / Cinzas-Branças



EN388: 2016  
CAT II  
2121X

Ref				
1100 0123-6	12	144	1,22	
1100 0123-7	12	144	1,22	
1100 0123-8	12	144	1,22	
1100 0123-9	12	144	1,22	
1100 0123-10	12	144	1,22	
1100 0123-11	12	144	1,22	

Ref				
1100 0123-6BL	12	144	1,47	✓
1100 0123-7BL	12	144	1,47	✓
1100 0123-8BL	12	144	1,47	✓
1100 0123-9BL	12	144	1,47	✓
1100 0123-10BL	12	144	1,45	✓
1100 0123-11BL	12	144	1,47	✓

**Poliuretano / Pu**

Gris / Gris / Grey / Grigio / Cinzentas



EN388: 2016  
CAT II  
1121X

Ref				
1100 0124-6	12	144	1,22	
1100 0124-7	12	144	1,22	
1100 0124-8	12	144	1,22	
1100 0124-9	12	144	1,22	
1100 0124-10	12	144	1,22	
1100 0124-11	12	144	1,22	

Ref				
1100 0124-6BL	12	144	1,47	✓
1100 0124-7BL	12	144	1,47	✓
1100 0124-8BL	12	144	1,47	✓
1100 0124-9BL	12	144	1,47	✓
1100 0124-10BL	12	144	1,47	✓
1100 0124-11BL	12	144	1,45	✓

GUANTES DE LÁTEX RUGOSO CON SOPORTE DE PUNTO / GANTS LATEX TEXTURE RUGUEUSE, SUPPORT POLYESTER/COTON  
KNITTED POLYESTER/COTTON GLOVES WITH COVER OF LATEX / GUANTO IN LATTICE, CON PUNTI RIVESTITI DI POLIESTERE/COTONE  
LUVAS DE LATEX ÁSPERAS COM MALHA

Naranja / Orange / Orange / Arancione / Laranja



EN388: 2016  
CAT II  
3243X

- ES Guante de látex, soporte de punto de poliéster/algodón y puño elástico. Alta adherencia, confort y muy flexible.
- FR Gants latex, support polyester/coton et poignée élastique. Très souple, haute adhérence, confort.
- EN Latex gloves, knitted polyester/cotton and elastic fist. High adherence, comfort and extremely flexible.
- IT Guanto in lattice, con punti rivestiti di poliestere/cotone e polsino elastico. Alta aderenza, confortevole e molto flessibile.
- PT Luvas de látex, malha de poliéster / algodão e punho elástico. Alta aderência, conforto e extremamente flexíveis.

Ref				
<b>1100 0053-8</b>	12	120	<b>2,60</b>	
<b>1100 0053-9</b>	12	120	<b>2,60</b>	
<b>1100 0053-10</b>	12	120	<b>2,60</b>	
<b>1100 0053-8BL</b>	12	120	<b>2,86</b>	✓
<b>1100 0053-9BL</b>	12	120	<b>2,86</b>	✓
<b>1100 0053-10BL</b>	12	120	<b>2,86</b>	✓

Verde / Verte / Green / Verde / Verde



EN388: 2016  
CAT II  
3243X

- ES Guante de látex, soporte de punto de poliéster/algodón y puño elástico. Alta adherencia, confort y muy flexible.
- FR Gants latex, support polyester/coton et poignée élastique. Très souple, haute adhérence, confort.
- EN Latex gloves, knitted polyester/cotton and elastic fist. High adherence, comfort and extremely flexible.
- IT Guanto in lattice, con punti rivestiti di poliestere/cotone e polsino elastico. Alta aderenza, confortevole e molto flessibile.
- PT Luvas de látex, malha de poliéster / algodão e punho elástico. Alta aderência, conforto e extremamente flexíveis.

Ref				
<b>1100 0050-8</b>	12	120	<b>2,60</b>	
<b>1100 0050-9</b>	12	120	<b>2,60</b>	
<b>1100 0050-10</b>	12	120	<b>2,60</b>	
<b>1100 0050-8BL</b>	12	120	<b>2,86</b>	✓
<b>1100 0050-9BL</b>	12	120	<b>2,86</b>	✓
<b>1100 0050-10BL</b>	12	120	<b>2,86</b>	✓

Azul / Blue / Blue / Blu / Azul



EN388: 2016  
CAT II  
3243X

- ES Guante de látex, soporte de punto de poliéster/algodón y puño elástico. Alta adherencia, confort y muy flexible.
- FR Gants latex, support polyester/coton et poignée élastique. Très souple, haute adhérence, confort.
- EN Latex gloves, knitted polyester/cotton and elastic fist. High adherence, comfort and extremely flexible.
- IT Guanto in lattice, con punti rivestiti di poliestere/cotone e polsino elastico. Alta aderenza, confortevole e molto flessibile.
- PT Luvas de látex, malha de poliéster / algodão e punho elástico. Alta aderência, conforto e extremamente flexíveis.

Ref				
<b>1100 0067-8</b>	12	120	<b>2,60</b>	
<b>1100 0067-9</b>	12	120	<b>2,60</b>	
<b>1100 0067-10</b>	12	120	<b>2,60</b>	
<b>1100 0067-8BL</b>	12	120	<b>2,86</b>	✓
<b>1100 0067-9BL</b>	12	120	<b>2,86</b>	✓
<b>1100 0067-10BL</b>	12	120	<b>2,86</b>	✓



## GUANTES DE LÁTEX / GANTS EN LATEX / LATEX GLOVES GUANTI IN LATEX / LUVAS DE LÁTEX



GUANTES DE LÁTEX NATURAL 100% NO FLOCADO / GANTS EN LATEX NATUREL 100% INTÉRIEUR LISSE / SATIN GLOVES 100% LATEX DUST FREE INTERNAL  
GUANTI NATURALI IN LATTICE 100% NON FLOCCATO / LUVAS DE LATEX 100% NATURAL SUPERFICIE INTERNA TRATADA



**SATINADO**

ES Guante de látex natural para limpieza, no florado. Espesor 0,38 mm.

FR Gants en latex naturel pour le nettoyage, non floqué. 0,38 mm d'épaisseur.

EN These gloves, made of natural latex, are intended for cleaning. They are not flocking. Thickness of 0,38mm.

IT Guanti in lattice naturale sono idonei per la pulizia, senza floccatura. Spessore di 0,38 cm.

PT Luvas de latex natural para limpeza, não flocado. Espessura de 0,38mm.

Ref	👤	📦	📦	📦	📦
<b>1100 0199-S</b>	T - 6,5 (S)	12	144	<b>1,55</b>	✓
<b>1100 0199-M</b>	T - 7,5 (M)	12	144	<b>1,55</b>	✓
<b>1100 0199-L</b>	T - 8,5 (L)	12	144	<b>1,55</b>	✓
<b>1100 0199-XL</b>	T - 9,5 (XL)	12	144	<b>1,55</b>	✓

**100% Látex Natural**

GUANTES DE LÁTEX AMARILLO PARA LIMPIEZA / GANT DE MÉNAGE EN LATEX / YELLOW LATEX HOUSEHOLD GLOVES  
GUANTI GIALLI IN LATTICE, PER PULIZIE / LUVAS DE LATEX AMARELAS PARA LIMPEZA



ES Guantes de látex amarillo para limpieza. Látex flocado de algodón. Longitud 30 cm. Espesor 0,38 mm.

FR Gants de ménage en latex jaune. Latex interne doublé de coton. Longueur 30 cm. Épaisseur 0.38 mm.

EN Yellow latex household gloves. Flocked cotton. Length: 30 cm. Thickness: 0,38 mm.

IT Guanti impregnati in lattice naturale. Floccatura interna in cotone. Lunghezza: 30 cm. Spessore: 0,38 mm.

PT Luvas domésticas de látex amarelas. Comprimento: 30 cm. Espessura: 0,38 mm.

Ref	👤	📦	📦	📦	📦
<b>1100 0018-6,5</b>	6,5 (S)	12	144	<b>1,15</b>	✓
<b>1100 0018-7,5</b>	7,5 (M)	12	144	<b>1,15</b>	✓
<b>1100 0018-8,5</b>	8,5 (L)	12	144	<b>1,15</b>	✓
<b>1100 0018-9,5</b>	9,5 (XL)	12	144	<b>1,15</b>	✓

**100% Látex Natural**

GUANTES LÁTEX BICOLOR / GANTS LATEX BICOLORE / LATEX GLOVES TWO-COLORED / GUANTI LATEX BICOLORE / LUVAS LATEX BICOLOR



ES Guante de látex reforzado 100%. Excelentes en contacto con solventes, productos detergentes. Ideales para la construcción, la industria mecánica y para la aplicación de la fibra de vidrio. Longitud: 33 cm.

FR Gants en latex 100%. Excellents au contact de solvants, produits détergents. Excellents dans le secteur du bâtiment, dans l'industrie mécanique et dans l'application de la fibre de verre. Longueur: 33 cm.

EN 100% latex gloves. Excellent for contact with solvents, cleaning products, suitable for the building and engineering industries and for the application of glass resins. Length: 33 cm.

IT Guanto in lattice 100% rinforzato. Eccellente con il contatto dei solventi e prodotti detergenti. Ideale per le costruzioni, applicazioni in fibra di vetro e nell'industria meccanica. Lunghezza: 33 cm.

PT Luvas 100% látex. Excelentes para trabalhos com solventes, produtos de limpeza. Ideais para a construção, indústria mecânica e para a aplicação de fibra de vidro. Comprimento: 33 cm.

Ref	👤	📦	📦	📦	📦
<b>1100 0169-8</b>	T8	12	144	<b>1,68</b>	✓
<b>1100 0169-9</b>	T9	12	144	<b>1,68</b>	✓
<b>1100 0169-10</b>	T10	12	144	<b>1,68</b>	✓

**100% Látex Natural  
REFORZADO EXTRA - HEAVY DUTY**



**GUANTES DE NEOPRENO 100% / GANTS EN NÉOPRÈNE 100% / 100% NEOPRENE GLOVES**  
**GUANTI 100% NEOPRENE / LUVAS DE NEOPRENE 100%**

**100% Neopreno**



ES Guante de neopreno 100%. Excelente contacto con ácidos, detergentes y desinfectantes. Ideales para los sectores metalúrgico y mecánico. Longitud: 32 cm.

FR Gants en néoprène 100%. Efficaces au contact d'acides, de détergents, de désinfectants. Idéal pour une utilisation dans le secteur industrie métallurgique, mécanique. Longueur: 32 cm.

EN 100% neoprene gloves. Excellent for contact with acids, detergents and cleaning agents. Excellent for the metallurgy and engineering industries. Length: 32 cm.

IT Guanti 100% neoprene, interno liscio. Bordo della manichetta liscio. Eccellenti al contatto con acidi, detergenti e disinfettanti. Ideali per il settore metalurgico e meccanico. Lunghezza: 32 cm.

PT Excelentes para o contato com ácidos, detergentes e agentes de limpeza. Ideais para os setores metalúrgico e mecânico. Comprimento: 32cm.

Ref	↕	📦	📦	📦	📦
<b>1100 0166-8</b>	T8	12	144	<b>4,15</b>	✓
<b>1100 0166-9</b>	T9	12	144	<b>4,15</b>	✓
<b>1100 0166-10</b>	T10	12	144	<b>4,15</b>	✓

**GUANTES DE NITRILLO VERDE / GANTS NITRILES VERT / GREEN NITRILE GLOVES / GUANTI VERDI IN NITRILE / LUVAS DE NITRILLO VERDES**

**100% Nitrilo**



ES Guantes nitrilo verde flocado de algodón interior. Excelente resistencia al aceite, lejías, grasas y disolventes. Longitud: 33 cm. Grosor: 0,40 mm.

FR Gants nitriles vert doublés de coton. Résistance à l'huile, à l'eau de javel, aux graisses et aux dissolvants. Longueur: 33 cm. Grosseur : 0.40 mm.

EN Green nitrile gloves with flocklined interior. Excellent resistance to oil, fat, bleaching agents and solvents. Length: 33 cm. Thickness: 0,40 mm.

IT 100% Nitrile, lattice acrilico nitrile verde. Floccatura in cotone. Lunghezza: 33 cm. Spessore: 0,40 mm.

PT Luvras de borracha nitrílica verdes, interior confortável. Excelente resistência contra, gordura, óleo, agentes clareadores e solventes. Comprimento: 33 cm. Espessura: 0,40 mm.

Ref	↕	📦	📦	📦	📦
<b>1100 0143-6,5</b>	6,5 (S)	12	144	<b>2,58</b>	✓
<b>1100 0143-7,5</b>	7,5 (M)	12	144	<b>2,58</b>	✓
<b>1100 0143-8,5</b>	8,5 (L)	12	144	<b>2,58</b>	✓
<b>1100 0143-9,5</b>	9,5 (XL)	12	144	<b>2,58</b>	✓
<b>1100 0143-10,5</b>	10,5 (XXL)	12	144	<b>2,58</b>	✓

**GUANTES DE PVC / GANTS EN PVC / LATEX PVC / GUANTI IN PVC / LUVAS DE PVC**

**GUANTES DE PVC ESTANCO, 27 Ó 35 CM / GANTS ÉTANCHES PVC, 27 OU 35 CM / IMPERMEABLE PVC GLOVES, 27 OR 35 CM**  
**GUANTI IN STAGNO PVC, 27 O 35 CM / LUVAS IMPREMEÁVEIS PVC, 27 OU 35 CM**



ES Guantes PVC estanco de 27 ó 35 cm. Protegen contra grasas, detergentes diluidos, petróleo, etc. Ideal para limpieza de cisternas, etc.

FR Gants étanches PVC, manchette de 27 ou 35 cm. Protège des graisses, des détergents, des carburants etc. Idéal pour entretien des citernes.

EN Impermeable PVC gloves 27 or 35 cm. Protect against grease, diluted detergents, oils, etc. Ideal to be used when cleaning cisterns and tanks.

IT Guanto PVC rosso da 27 o 35 cm. Protegge da grassi, detergenti diluiti, petroli, ecc. Ideale per la pulizia dei serbatoi.

PT Luvras impremeáveis 27 ou 35 cm. Protege contra gorduras, detergentes diluídos, óleos, etc. Ideal para serem usadas na limpeza de cisternas e tanques.

Ref	↔	📦	📦	📦	📦
<b>1100 0045</b>	27 cm	12	120	<b>3,33</b>	
<b>1100 0046</b>	35 cm	12	120	<b>4,37</b>	
<b>1100 0045BL</b>	27 cm	12	120	<b>3,74</b>	✓
<b>1100 0046BL</b>	35 cm	12	120	<b>4,78</b>	✓





CAJA DISPENSADORA DE GUANTES AMBIDIESTROS / BOITE DISTRIBUTRICE DE GANTS AMBIDEXTRES  
 DISPENSER BOX WITH AMBIDEXTROUS GLOVES / CONFEZIONE DI GUANTI AMBIDESTRI / CAIXA DE LUVAS AMBIDESTRAS

**100% Nitrilo**  
**Sin polvillo**  
**Powder free**



**Bricofan**



ES Caja dispensadora de guantes finos. Compatible uso alimentario. Longitud 24 cm. AQL 1,5.  
 FR Boite distributrice de gants. Compatible contact alimentaire. Longueur 24 cm. AQL 1,5.  
 EN Dispenser box with gloves. Suitable for contact with food. Length 24 cm. AQL 1,5.  
 IT Guanti fini. Bordino arrotolato, finitura esterna liscia. Lunghezza 24 cm. AQL 1,5.  
 PT Contém luvas finas. Indicadas para contato com alimentos. Comprimento 24 cm. AQL 1,5.

Ref						
1100 1014-S	S	10 pcs	1	14	2,04	✓
1100 1014-M	M	10 pcs	1	14	2,04	✓
1100 1014-L	L	10 pcs	1	14	2,04	✓

**100% Nitrilo**  
**Sin polvillo**  
**Powder free**



ES Caja dispensadora de guantes finos. Compatible uso alimentario. Longitud 24 cm. AQL 1,5.  
 FR Boite distributrice de gants. Compatible contact alimentaire. Longueur 24 cm. AQL 1,5.  
 EN Dispenser box with gloves. Suitable for contact with food. Length 24 cm. AQL 1,5.  
 IT Guanti fini. Bordino arrotolato, finitura esterna liscia. Lunghezza 24 cm. AQL 1,5.  
 PT Contém luvas finas. Indicadas para contato com alimentos. Comprimento 24 cm. AQL 1,5.

Ref					
1100 0014 - S	6 - 7 ( S )	100 pcs	1	10	10,40
1100 0014 - M	7 - 8 ( M )	100 pcs	1	10	10,40
1100 0014 - L	8 - 9 ( L )	100 pcs	1	10	10,40
1100 0014- XL	9-10 ( XL )	100 pcs	1	10	10,40

**100% Nitrilo**  
**Sin polvillo**  
**Powdered**  
**EXTRA**



**Grueso y extrafuerte**  
**Lourd et extra-fort**  
**Thick and extra-strong**  
**Spesso e extraforte**  
**Grosso e extra forte**

ES Caja dispensadora de guantes finos. Compatible uso alimentario. Longitud 24 cm. AQL 1,5.  
 FR Boite distributrice de gants. Compatible contact alimentaire. Longueur 24 cm. AQL 1,5.  
 EN Dispenser box with gloves. Suitable for contact with food. Length 24 cm. AQL 1,5.  
 IT Guanti fini. Bordino arrotolato, finitura esterna liscia. Lunghezza 24 cm. AQL 1,5.  
 PT Contém luvas finas. Indicadas para contato com alimentos. Comprimento 24 cm. AQL 1,5.

Ref					
1100 0214 - S	6 - 7 ( S )	100 pcs	1	10	19,87
1100 0214 - M	7 - 8 ( M )	100 pcs	1	10	19,87
1100 0214 - L	8 - 9 ( L )	100 pcs	1	10	19,87
1100 0214- XL	9-10 ( XL )	100 pcs	1	10	19,87

**100% Nitrilo**  
**Sin polvillo**  
**Powder free**



ES Caja dispensadora de guantes finos. Compatible uso alimentario. Longitud 24 cm. AQL 1,5.  
 FR Boite distributrice de gants. Compatible contact alimentaire. Longueur 24 cm. AQL 1,5.  
 EN Dispenser box with gloves. Suitable for contact with food. Length 24 cm. AQL 1,5.  
 IT Guanti fini. Bordino arrotolato, finitura esterna liscia. Lunghezza 24 cm. AQL 1,5.  
 PT Contém luvas finas. Indicadas para contato com alimentos. Comprimento 24 cm. AQL 1,5.

Ref					
1100 0015 - S	6 - 7 ( S )	100 pcs	1	10	13,73
1100 0015 - M	7 - 8 ( M )	100 pcs	1	10	13,73
1100 0015 - L	8 - 9 ( L )	100 pcs	1	10	13,73
1100 0015- XL	9-10 ( XL )	100 pcs	1	10	13,73

**100% Látex**  
**Con polvillo**  
**Powdered**



**Bricofan**



ES Caja dispensadora de guantes finos. Compatible uso alimentario. Longitud 24 cm. AQL 1,5.  
 FR Boite distributrice de gants. Compatible contact alimentaire. Longueur 24 cm. AQL 1,5.  
 EN Dispenser box with gloves. Suitable for contact with food. Length 24 cm. AQL 1,5.  
 IT Guanti fini. Bordino arrotolato, finitura esterna liscia. Lunghezza 24 cm. AQL 1,5.  
 PT Contém luvas finas. Indicadas para contato com alimentos. Comprimento 24 cm. AQL 1,5.

Ref						
1100 1011-S	S	10 pcs	1	14	1,73	✓
1100 1011-M	M	10 pcs	1	14	1,73	✓
1100 1011-L	L	10 pcs	1	14	1,73	✓



CAJA DISPENSADORA DE GUANTES AMBIDIESTROS / BOITE DISTRIBUTRICE DE GANTS AMBIDEXTRES  
DISPENSER BOX WITH AMBIDEXTROUS GLOVES / CONFEZIONE DI GUANTI AMBIDESTRI / CAIXA DE LUVAS AMBIDESTRAS

**100% Látex  
Con polvillo  
Powdered**



ES Caja dispensadora de guantes finos. Compatible uso alimentario. Longitud 24 cm. AQL 1,5.  
FR Boite distributrice de gants. Compatible contact alimentaire. Longueur 24 cm. AQL 1,5.  
EN Dispenser box with gloves. Suitable for contact with food. Length 24 cm. AQL 1,5.  
IT Guanti fini. Bordino arrotolato, finitura esterna liscia. Lunghezza 24 cm. AQL 1,5.  
PT Contém luvas finas. Indicadas para contato com alimentos. Comprimento 24 cm. AQL 1,5.

Ref	👤	⬇️	📦	📦	📦
<b>1100 0011 - S</b>	6-7 (S)	100 pcs	1	10	<b>7,57</b>
<b>1100 0011 - M</b>	7-8 (M)	100 pcs	1	10	<b>7,57</b>
<b>1100 0011 - L</b>	8-9 (L)	100 pcs	1	10	<b>7,57</b>
<b>1100 0011- XL</b>	9-10 (XL)	100 pcs	1	10	<b>7,57</b>

**100% Látex  
Sin polvillo  
Powder free**



ES Caja dispensadora de guantes finos. Compatible uso alimentario. Longitud 24 cm. AQL 1,5.  
FR Boite distributrice de gants. Compatible contact alimentaire. Longueur 24 cm. AQL 1,5.  
EN Dispenser box with gloves. Suitable for contact with food. Length 24 cm. AQL 1,5.  
IT Guanti fini. Bordino arrotolato, finitura esterna liscia. Lunghezza 24 cm. AQL 1,5.  
PT Contém luvas finas. Indicadas para contato com alimentos. Comprimento 24 cm. AQL 1,5.

Ref	👤	⬇️	📦	📦	📦
<b>1100 0271 - S</b>	6-7 (S)	100 pcs	1	10	<b>12,90</b>
<b>1100 0271 - M</b>	7-8 (M)	100 pcs	1	10	<b>12,90</b>
<b>1100 0271 - L</b>	8-9 (L)	100 pcs	1	10	<b>12,90</b>
<b>1100 0271- XL</b>	9-10 (XL)	100 pcs	1	10	<b>12,90</b>

**100% Vinilo  
Con polvillo  
Powdered**



ES Caja dispensadora de guantes finos. Compatible uso alimentario. Longitud 24 cm. AQL 1,5.  
FR Boite distributrice de gants. Compatible contact alimentaire. Longueur 24 cm. AQL 1,5.  
EN Dispenser box with gloves. Suitable for contact with food. Length 24 cm. AQL 1,5.  
IT Guanti fini. Bordino arrotolato, finitura esterna liscia. Lunghezza 24 cm. AQL 1,5.  
PT Contém luvas finas. Indicadas para contato com alimentos. Comprimento 24 cm. AQL 1,5.

Ref	👤	⬇️	📦	📦	📦
<b>1100 0162 - S</b>	6-7 (S)	100 pcs	1	10	<b>7,31</b>
<b>1100 0162 - M</b>	7-8 (M)	100 pcs	1	10	<b>7,31</b>
<b>1100 0162 - L</b>	8-9 (L)	100 pcs	1	10	<b>7,31</b>
<b>1100 0162- XL</b>	9-10 (XL)	100 pcs	1	10	<b>7,31</b>

**100% Vinilo Azul  
100% Blue Vinile  
Sin polvillo  
Powder free**



ES Caja dispensadora de guantes finos. Compatible uso alimentario. Longitud 24 cm. AQL 1,5.  
FR Boite distributrice de gants. Compatible contact alimentaire. Longueur 24 cm. AQL 1,5.  
EN Dispenser box with gloves. Suitable for contact with food. Length 24 cm. AQL 1,5.  
IT Guanti fini. Bordino arrotolato, finitura esterna liscia. Lunghezza 24 cm. AQL 1,5.  
PT Contém luvas finas. Indicadas para contato com alimentos. Comprimento 24 cm. AQL 1,5.

Ref	👤	⬇️	📦	📦	📦
<b>1100 0225 - S</b>	6-7 (S)	100 pcs	1	10	<b>7,53</b>
<b>1100 0225 - M</b>	7-8 (M)	100 pcs	1	10	<b>7,53</b>
<b>1100 0225 - L</b>	8-9 (L)	100 pcs	1	10	<b>7,53</b>
<b>1100 0225- XL</b>	9-10 (XL)	100 pcs	1	10	<b>7,53</b>



**GUANTES DESECHABLES / GANTS JETABLES / DISPOSABLE GLOVES  
GUANTI MONOUSO / LUVAS DESCARTÁVEIS**



CAJA DE 10.000 GUANTES DE POLIETILENO (HDPE) TALLA ÚNICA / BOÎTE DE 10000 GANTS POLYÉTHYLÈNE (PEHD) TAILLE UNIQUE  
10,000 CLEAR HDPE POLYETHYLENE GLOVES BOX ONE-SIZE-FITS-ALL / GUANTI IN POLIETILENE AD ALTA DENSITÀ (HDPE) TAGLIA UNICA CONFEZIONE DA 10.000 PEZZI  
CAIXA DE 10.000 LUVAS DE POLIETILENO (HDPE) TAMANHO ÚNICO



CAT I **UNE-EN 1186:2002**

**Fabricado con Polietileno de Alta Densidad (HDPE) transparente.  
Talla única.**

**These gloves are made of clear high density polyethylene (HDPE).  
One-size-fits-all.**

ES Destinados para evitar la contaminación de los productos ya manipulados, así como para proteger las manos al usuario de la suciedad. Uso preferente en supermercados y grandes superficies (autoservicio de frutas y congelados). En estaciones de servicio para evitar el contacto directo con lubricantes. El producto mantendrá sus propiedades siempre que se almacene en lugares secos a temperatura entre 10 °C y 30 °C. No los exponga a la luz directa del sol.

FR Conçu pour éviter la contamination des produits déjà manipulés, ainsi que pour protéger les mains de l'utilisateur de la saleté. Utilisation préférentielle dans les supermarchés et les grands magasins (légumes en libre-service et surgelés). Dans les stations-service pour éviter tout contact direct avec les lubrifiants. Le produit conservera ses propriétés tant qu'il est stocké dans des endroits secs à des températures comprises entre 10 °C et 30 °C. Ne les exposez pas à la lumière directe du soleil.

EN They are intended to avoid contamination of handled products, as well as to protect the user's hand from dirt. These can be used mainly in supermarkets, large surfaces (such as a self-service fruit shop and frozen products), or in service stations in order to avoid the direct contact with lubricants. The features of these gloves will be preserved by having it stored in dry surfaces at a temperature between 10 and 30°C. Do not expose to direct sunlight.

IT Destinati a evitare la contaminazione di un prodotto manipolato e proteggere anche le mani dell'utente dalla sporcizia. Possono essere utilizzati in supermercati, grandi superfici (come nel self-service di congelati e fruttivendolo) e stazioni di servizio dove entra in contatto con lubrificanti. Il prodotto mantiene le sue proprietà se lo conserva ad una temperatura compresa tra 10 - 30°C. Non esporre alla luce solare diretta.

PT Destinados para evitar a contaminação dos produtos já manipulados, assim como para proteger as mãos do usuário da sujidade. Uso preferente em supermercados y grandes superficies (auto-serviço frutaria e congelados). Em estações de serviço para evitar o contacto direto com os lubrificantes. O produto manterá as suas propriedades sempre que for armazenado em lugares secos a temperaturas entre os 10°C e 30°C. não os exponha á luz direta do sol.

Ref		
1100 0269	10.000 uds	129,10

**GAFAS DE SEGURIDAD / LUNETTES DE SÉCURITÉ / SAFETY GLASSES  
OCCHIALI DI SICUREZZA / ÓCULOS DE SEGURANÇA**

EXPOSITOR GAFAS POLARIZADAS Y GRADUADAS / PRESENTOIR LUNETTES POLARISÉES ET GRADUÉES  
DISPLAY STAND FOR POLARISED AND PRESCRIPTION GLASSES / ESPOSITORE OCCHIALI POLARIZZATI E GRADUATI  
ESPOSITOR DE ÓCULOS POLARIZADOS E GRADUADOS

**TEST POLARIDAD  
POLARITY TEST**



ES El expositor se suministra sin gafas.  
FR Le présentoir est fourni sans lunette.  
EN The display stand is supplied without glasses.  
IT L'espositore viene fornito senza occhiali.  
PT O expositor é fornecido sem os óculos.

Ref		
EXPOSITOR25	1	92,50

Gafa de seguridad monofocal graduada / Lunettes de sécurité monofocales graduées / Prescription safety glasses monofocal  
occhiale di sicurezza con lenti graduate monofocali / Óculos de segurança monofocal C/ graduação



EN 166 **S**

Ref					
1100 0901	1,0 Dioptrías	1	12	44,70	✓
1100 0902	1,5 Dioptrías	1	12	44,70	✓
1100 0903	2,0 Dioptrías	1	12	44,70	✓
1100 0904	2,5 Dioptrías	1	12	44,70	✓
1100 0905	3,0 Dioptrías	1	12	44,70	✓

Gafa seguridad sport working polarizada / Lunettes de sécurité sport working polarisée / Safety glasses sport working polarised  
occhiale di sicurezza/lavoro/sportivo, con lenti polarizzate / Óculos de segurança sport working polarizados



EN 166 + EN 172 **F T**

Ref				
1100 0909	1	12	42,65	✓

Gafas seguridad - typical / Lunettes de sécurité - typical / Safety glasses - typical  
occhiali di protezione - typical / Óculos de segurança - typical



EN166: 2001  
EN170  
EN172  
CAT II

Ref			
1100 0320	1	12	2,50

Gafas seguridad - standard / Lunettes de sécurité - standard / Safety glasses - standard  
occhiali di sicurezza - standard / Óculos de segurança - standard



EN166: 2001  
CAT II



Ref				
1100 0024	1	12	4,99	
1100 0024BL	1	12	5,72	✓



**GAFAS DE SEGURIDAD / LUNETTES DE SÉCURITÉ / SAFETY GLASSES  
OCCHIALI DI SICUREZZA / ÓCULOS DE SEGURANÇA**



GAFAS SEGURIDAD - EYES 2000 / LUNETTES DE SÉCURITÉ - EYES 2000 / SAFETY GLASSES - EYES 2000  
OCCHIALI DI SICUREZZA - EYES 2000 / ÓCULOS DE SEGURANÇA - EYES 2000



**EN166: 2001  
EN172:1994/A1:2000/A2:2001  
CAT II**



Ref				
1100 0023	1	12	6,14	
1100 0023BL	1	12	7,70	✓

GAFAS SEGURIDAD ULTRAVIOLETA / LUNETTES DE SÉCURITÉ ULTRAVIOLETS / ULTRAVIOLET SAFETY GLASSES  
OCCHIALI DI PROTEZIONE CONTRO GLI ULTRAVIOLETTI / ÓCULOS DE SEGURANÇA ULTRAVIOLETA



**EN 166:2001  
EN 167:2001  
EN 168:2001  
EN 170:2002  
EN 172 + A2:2001  
CAT II**



**UV PROTECTION**

Ref				
1100 0021	1	12	4,99	
1100 0021BL	1	12	5,78	✓

GAFAS SEGURIDAD - FUSIÓN / LUNETTES DE SÉCURITÉ - FUSION / SAFETY GLASSES - FUSION  
OCCHIALI DI PROTEZIONE - FUSION / ÓCULOS DE SEGURANÇA - FUSION



**EN 166:2001  
EN 167:2001  
EN 168:2001  
EN 170:2002  
EN 172 + A2:2001  
CAT II**

Ref				
1100 0323	1	12	6,97	

GAFAS SEGURIDAD - BLUE ELASTIC / LUNETTES DE SÉCURITÉ - BLUE ÉLASTIC / SAFETY GLASSES - BLUE ELASTIC  
OCCHIALI DI PROTEZIONE - BLU ELASTICO / ÓCULOS DE SEGURANÇA - BLUE ELASTIC



**EN 166:2001  
EN 167:2001  
EN 168:2001  
EN 170:2002  
EN 172 + A2:2001  
CAT II**

Ref				
1100 0322	1	12	4,99	

GAFAS SEGURIDAD ANATÓMICA / LUNETTES DE SECURITE ANATOMIQUES / ANATOMICAL SAFETY GLASSES  
OCCHIALE DI SICUREZZA ANATOMICO / ÓCULOS DE PROTEÇÃO ANATÓMICOS



**EN166: 2001  
EN170  
EN172  
CAT II**



Ref				
1100 0321	1	12	6,14	
1100 0321BL	1	12	6,76	✓



GAFAS SEGURIDAD SPORT CLEAR UV PROTECCIÓN / LUNETTES DE SÉCURITÉ SPORT CLEAR PROTECTION UV / SAFETY GLASSES SPORT CLEAR UV PROTECTION  
OCCHIALI DI SICUREZZA CON SPORT CLEAR PROTEZIONE UV / ÓCULOS SEGURANÇA SPORT CLEAR UV PROTECTION



CE  
EN166: 2001  
CAT II



ES Con patillas ajustables.  
FR Branches réglables.  
EN With adjustable arms.  
IT Con braccia regolabili.  
PT Com hastes ajustáveis.

ES Policarbonato resistente al rayado.  
FR Polycarbonate résistant aux rayures.  
EN Scratch resistant polycarbonate glasses.  
IT Occhiali in policarbonato resistente ai graffi.  
PT Policarbonato resistente aos riscos.

Ref				
1100 0391	1	12	6,95	✓

GAFAS DE SEGURIDAD SPORT ÁMBAR PROTECCIÓN UV / LUNETTES DE SÉCURITÉ SPORT AMBAR PROTECTION UV / SAFETY GLASSES SPORT AMBAR UV PROTECTION  
OCCHIALI DI SICUREZZA SPORT AMBAR PROTEZIONE UV / ÓCULOS SEGURANÇA SPORT AMBAR UV PROTECTION



CE  
EN166: 2001  
CAT II



ES Con patillas ajustables.  
FR Branches réglables.  
EN With adjustable arms.  
IT Con braccia regolabili.  
PT Com hastes ajustáveis.

ES Policarbonato resistente al rayado.  
FR Polycarbonate résistant aux rayures.  
EN Scratch resistant polycarbonate glasses.  
IT Occhiali in policarbonato resistente ai graffi.  
PT Policarbonato resistente aos riscos.

Ref				
1100 0392	1	12	6,95	✓

GAFAS DE SEGURIDAD SPORT OSCURA PROTECCIÓN UV / LUNETTES DE SÉCURITÉ SPORT OSCURA PROTECTION UV / SAFETY GLASSES SPORT OSCURA UV PROTECTION  
OCCHIALI DI SICUREZZA SPORT OSCURA PROTEZIONE UV / ÓCULOS SEGURANÇA SPORT OSCURA UV PROTECTION



CE  
EN166: 2001  
CAT II



ES Con patillas ajustables.  
FR Branches réglables.  
EN With adjustable arms.  
IT Con braccia regolabili.  
PT Com hastes ajustáveis.

ES Policarbonato resistente al rayado.  
FR Polycarbonate résistant aux rayures.  
EN Scratch resistant polycarbonate glasses.  
IT Occhiali in policarbonato resistente ai graffi.  
PT Policarbonato resistente aos riscos.

Ref				
1100 0393	1	12	7,50	✓

GAFAS DE SEGURIDAD ENVOLVENTE PROTECCIÓN UV / LUNETTES DE SÉCURITÉ ENVELOPPANTE PROTECTION UV / WRAPAROUND SAFETY GLASSES UV PROTECTION  
OCCHIALI DI SICUREZZA AVVOLGENTI PROTEZIONE UV / ÓCULOS SEGURANÇA ENVOLVENTE UV PROTECTION



CE  
EN166: 2001  
CAT II



ES Con patillas ajustables.  
FR Branches réglables.  
EN With adjustable arms.  
IT Con braccia regolabili.  
PT Com hastes ajustáveis.

ES Policarbonato con tratamiento antirayaduras, con puente de goma suave y cómodo.  
FR Polycarbonate avec traitement anti-rayures, avec pont de nez en caoutchouc souple et confortable.  
EN Polycarbonate glasses with scratch-resistant coating, and a soft and comfortable rubber bridge.  
IT Occhiali in policarbonato con trattamento antigraffio e ponte in gomma morbida e comoda.  
PT Policarbonato com tratamento anti-riscos, com ponte de borracha suave e cómoda.

Ref				
1100 0394	1	12	6,50	✓





**GAFAS DE SEGURIDAD / LUNETTES DE SÉCURITÉ / SAFETY GLASSES  
OCCHIALI DI SICUREZZA / ÓCULOS DE SEGURANÇA**



**GAFAS SEGURIDAD SÚPER LIGERA 18G LENTE CLARA / LUNETTES DE SECURITE SUPER LEGERE 18G VERRE CLAIR  
SUPER LIGHTWEIGHT SAFETY GLASSES 18G LIGHT LENS / OCCHIALI DI SICUREZZA SUPER LEGGERI 18G LENTE CHIARA  
OCULOS SEGURANÇA SUPER LIGEIRA 18G LENTE CLARA**



**CE**  
**EN166: 2001**  
**CAT II**

- ES Peso ultraligero / Súper flexible / Protección contra rayos UV / Resistente a los arañazos / Resistente a los golpes / Revestimiento antiempañamiento
- FR Poids ultraléger / Super flexible / Protection contre les rayons UV / Résistant aux rayures / Résistant aux coups / Revêtement antibuée
- EN Ultra lightweight / Super flexible / UV ray protection / Scratch resistant / Impact resistant / Anti-fog coating
- IT Peso ultraleggero / Super flessibile / Protezione contro i raggi UV / Resistente ai graffi / Resistente allo colpi / Rivestimento anti-appannamento
- PT Peso ultraleve / super flexível / Protecção contra raios uv / Resistente a arranhaços / Resistente a choques / Revestimento anti-embacante

Ref				
<b>1100 0395</b>	1	12	<b>4,80</b>	✓

**GAFAS SEGURIDAD SÚPER LIGERA 18G LENTE OSCURA / LUNETTES DE SECURITE SUPER LIGERA 18G VERRE OBSCUR  
SUPER LIGHTWEIGHT SAFETY GLASSES 18G DARK LENS / OCCHIALI DI SICUREZZA SUPER LEGGERI 18G LENTE SCURA  
OCULOS SEGURANÇA SUPER LIGEIRA 18G LENTE OSCURA**



**CE**  
**EN166: 2001**  
**CAT II**

- ES Peso ultraligero / Súper flexible / Protección contra rayos UV / Resistente a los arañazos / Resistente a los golpes / Revestimiento antiempañamiento
- FR Poids ultraléger / Super flexible / Protection contre les rayons UV / Résistant aux rayures / Résistant aux coups / Revêtement antibuée
- EN Ultra lightweight / Super flexible / UV ray protection / Scratch resistant / Impact resistant / Anti-fog coating
- IT Peso ultraleggero / Super flessibile / Protezione contro i raggi UV / Resistente ai graffi / Resistente allo colpi / Rivestimento anti-appannamento
- PT Peso ultraleve / super flexível / Protecção contra raios uv / Resistente a arranhaços / Resistente a choques / Revestimento anti-embacante

Ref				
<b>1100 0396</b>	1	12	<b>4,80</b>	✓

**GAFAS DE SEGURIDAD PROTECCIÓN UV / LUNETTES DE SÉCURITÉ PROTECTION UV / SAFETY GLASSES UV PROTECTION  
OCCHIALI DI SICUREZZA PROTEZIONE UV / ÓCULOS SEGURANÇA UV PROTECTION**



**CE**  
**EN166: 2001**  
**CAT II**

Ref				
<b>1100 0397</b>	1	12	<b>2,60</b>	✓

**GAFAS SEGURIDAD OSCURA ACOLCHADA 4 EN 1 / LUNETTES DE SÉCURITÉ NOIRES REMBOURRÉES "4 EN 1" / DARK PADDED SAFETY GOGGLES 4 IN 1  
OCCHIALI DI SICUREZZA IMBOTTITE SCURI 4 IN 1 / ÓCULOS DE SEGURANÇA ESCUROS ALCOCHOADOS 4 EM 1**



**CE**  
**2797**  
**EN 166**



Ref				
<b>1100 0399</b>	1	12	<b>13,40</b>	✓

GAFAS DE SEGURIDAD, ANTIPROYECCIONES, DOBLE PROTECCIÓN, CRISTAL ANTIVAHUO / LUNETTES DE SÉCURITÉ, DOUBLE PROTECTION, VERRE ANTIBUÉE  
SAFETY SPECTACLE, DOUBLE PROTECTION, DEMISTER GLASS / OCCHIALI DI SICUREZZA, DOPPIA PROTEZIONE, CRISTALLO ANTICONDENSA  
ÓCULOS DE SEGURANÇA, ANTI-PROJEÇÕES, DUPLA PROTEÇÃO, ANTI-CONDENSAÇÃO



CE  
EN166: 2001  
CAT II  
OPTICAL GLASS 1

Ref			
1100 0020	1	12	4,06

GAFAS SEGURIDAD VISIÓN PANORÁMICA / LUNETTES DE SÉCURITÉ VUE PANORAMIQUE / PANORAMIC VIEW GOGGLES  
OCCHIALI VISTA PANORAMICA / ÓCULOS DE PROTEÇÃO VISÃO PANORÂMICA



CE  
EN166: 2001  
ANSI Z87.1  
OPTICAL GLASS 1



Ref				
1100 0027	1	12	7,81	
1100 0027BL	1	12	9,14	✓

EXPOSITOR GAFAS / PRÉSENTOIR LUNETTES / SAFETY GLASSES DISPLAY STAND / ESPOSITORE OCCHIALI / EXPOSITOR PARA ÓCULOS



Ref	Ref				
1100 9999	1100 0322	12	72 pcs	310 x 540 mm	449,50
	1100 0021	12			
	1100 0023	12			
	1100 0024	12			
	1100 0321	12			
	1100 0323	12			
	EXPOSITOR 3	1			

Ref	Ref				
Sólo Display	EXPOSITOR 3	1	1	310 x 540 mm	98,40



PANTALLAS PROTECCIÓN FÁCIL AJUSTE MANUAL, MÁXIMA SEGURIDAD / ECRAN DE PROTECTION, REGLAGE FACILE, SECURITE MAXIMUM  
FACESHIELD, EASY FITTING, MAX. SAFETY, SPARE SHIELD / SCHERMO DI PROTEZIONE DI FACILE REGOLAZIONE MANUALE, MASSIMA SICUREZZA  
VISEIRAS PROTETORAS, AJUSTE MANUAL FÁCIL, MAX. SEGURANÇA



**CE**  
**EN166: 2001**  
**CAT II**  
**OPTICAL GLASS 1**  
**EN 1731:2006**

Ref		
1100 0031	1	14,40



**EN 1731: 2006**  
**CAT II**

Ref			
RECAMBIO 1100 0302	20 x 40 cm	1	5,90



**EN166: 2001**  
**CAT II**

Ref			
RECAMBIO 1100 0303	20 x 40 cm	1	6,24



**TINTADO N°5**  
**EN 166: 2001**  
**EN 170: 2002**  
**CAT II**

Ref			
RECAMBIO 1100 0195	20 x 40 cm	1	9,89

GAFAS ABATIBLES DE PROTECCIÓN / LUNETTES DE SÉCURITÉ / SAFETY FOLDING GOGGLES  
OCCHIALI PROTETTIVI / ÓCULOS DE PROTEÇÃO DOBRÁVEL



**CE**  
**EN166: 2001**  
**EN-175-1997**  
**CAT II**

ES Gafas abatibles de soldador con oculares redondos, tintado 5. Usos: Autógena, soldadura con soplete, soldaduras con llama.

FR Lunettes à souder, foyers rabattables ronds, teinte n°5. Utilisation: Soudure avec flamme.

EN Folding welding goggles with rounded glasses, tinted No.5.Uses: For welding with flame.

IT Occhiali ribaltabili per saldare, con oculari rotondi, vernice n° 5. Uso: Saldature autogene, con fiamme ossidriche e fiamme di saldatura.

PT Óculos dobráveis de soldagem com lentes redondas, matizado 5. Aplicações: Soldagem, maçarico de soldar, soldagem com chama.

Ref				
1100 0022	N°5	1	12	7,80

MÁSCARA DE SOLDADURA / MASQUE À SOUDER / WELDING HELMET / MASCHERA DA SALDATURA / MÁSCARA DE SOLDAGEM

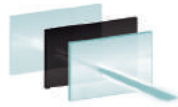

2 Blanco / White  
 1 Negro / Black

EN166: 2001  
 EN175: 1997  
 CAT II

ES Máscara de soldadura, ergonómica, fácilmente ajustable, doble protección, ventana vasculante, tintado 11. Usos: todo tipo de soldaduras.

FR Masque à souder, ergonomique, ajustement aise, double protection, écran basculant, teinte n° 11. Pour tout type de soudures.

EN Welding helmet, ergonomic, easy fitting, double protection, tip-up window, tinted No. 11. Uses: all types of weldings.

IT Maschera da saldatura, ergonomica, facilmente regolabile, doppia protezione, schermo basculante, vernice n. 11. Uso: Tutti tipi di saldatura.

PT Máscara de soldagem, ergonômica, ajuste fácil, proteção dupla, janela oscilante, matizado 11. Aplicações: todo o tipo de soldagens elétricas.

Ref			
1100 0030	Nº11	1	17,71

MÁSCARA DE SOLDADURA MANUAL CRISTAL Nº11 / MASQUE À SOUDER TRADITIONNEL Nº11 / WELDING HANDSHIELDS NO.11  
 MASCHERA A SALDATURA MANUALE Nº11 / MÁSCARA DE SOLDAGEM MANUAL VIDRO Nº11



1 Blanco / White  
 1 Negro / Black

EN166: 2001  
 EN175: 1997  
 CAT II

ES Máscara de soldadura manual cristal Nº11. Usos: todo tipo de soldaduras.

FR Masque à souder traditionnel Nº11. Pour tout type de soudures.

EN Welding handshields No.11. Uses: all types of weldings.

IT Maschera a saldatura manuale Nº11. Uso: Tutti tipi di saldatura.

PT Máscara de soldagem manual vidro Nº11. Aplicações: todo o tipo de soldagens elétricas.

Ref			
1100 0037	Nº11	1	9,52

CRISTALES DE SOLDADURA DE RECAMBIO / VERRES DE RECHANGE POUR SOUDER / SPARE GLASSES FOR WELDING  
 RICAMBIO CRISTALLI SALDATURA / REPOSIÇÃO DE VIDROS DE SOLDAGEM

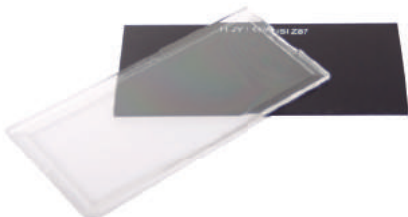

EN166: 2001  
 EN175: 1997  
 CAT II

ES Cristales de soldadura de recambio. Usos: todo tipo de soldaduras.

FR Verres de rechange pour souder. Pour tout type de soudures.

EN Spare glasses for welding. Uses: all types of weldings.

IT Ricambio cristalli saldatura. Uso: Tutti tipi di saldatura.

PT Reposição de vidros de soldagem. Aplicações: todo o tipo de soldagens elétricas.

Ref			
1100 0043	Nº 11 BLACK		1 1,31
1100 0044	WHITE		1 0,63

MÁSCARA DE SOLDADURA PARA CASCO DE OBRA CRISTAL Nº11 / MASQUE À SOUDER POUR ADAPTATION SUR CASQUE DE CHANTIER Nº 11  
 WELDING SHIELD FOR BUILDING HELMETS NO. 11 / MASCHERA PER SALDATURA PER CASCO DA LAVORO Nº 11  
 MÁSCARA DE SOLDAGEM PARA CAPACETES DE CONSTRUÇÃO, VIDRO Nº 11



EN175: 1997  
 CAT II



ES Máscara de soldadura para casco de obra cristal Nº11. Usos: todo tipo de soldaduras.

FR Masque à souder pour adaptation sur casque de chantier Nº 11. Pour tout type de soudures.

EN Welding shield for building helmets No. 11. Uses: all types of weldings.

IT Maschera per saldatura per casco da lavoro Nº 11. Uso: Tutti tipi di saldatura.

PT Máscara de soldagem para capacetes de construção, vidro Nº 11. Aplicações: todo o tipo de soldagens elétricas.

Ref			
1100 0193	Nº11	1	10,84



CASCO SOLDADURA AUTOMÁTICA (ARC/MIG/MAG/TIG) / MASQUE A SOUDER AUTOMATIQUE (ARC/MIG/MAG/TIG)  
AUTO DARKENING HELMET (ARC/MIG/MAG/TIG) / MASCHERA DI SALDATURA AUTOMATICA (ARC/MIG/MAG/TIG)  
CAPACETE DE SOLDAGEM AUTOMÁTICO (ARC/MIG/MAG/TIG)



**EN 175: 1997-2008  
EN 166:2001  
EN 379:2009-07  
EN 166:2002-04  
CAT II**

**Solar Power**



**Ref**

**1100 0280**



**59,95**

**ESPECIFICACIONES TÉCNICAS / TECHNICAL SPECIFICATIONS**

Área de visibilidad activa	Viewing area	98x43mm (3,86" x 1,69")
Tamaño de la lente	Cartridge size	110x90x9mm (4,33"x3,54"x0,35")
Protector UV/IR	UV/IR Protection	Up to Shade DIN 16 todo el rato
Estado de la luz	Light State	Shade DIN 4
Ajuste de sombra	Variable Shade	From DIN 9 a DIN 13
Suministro de Energía	Power Supply	Solar cells, No battery change required
Energía On/Off	Power On/Off	Fully Automatic.
Sensibilidad	Sensitivity	Outside can be continued adjustable
Función	Function	"WELDING"/"GRINDING" can be selective
Velocidad de encendido	Switching time	a) Light to Dark: 1/30000 s (0.000033 sec). (-5 0C, 0.0008sec) b) Dark to Light: 0.25 - 0.8 s (short - middle - long)
Temperatura de funcionamiento	Operating Temperature	-5°C a +55°C (23°F a 131°F)
Temperatura de almacenaje	Storing Temperature	-20°C a +70°C (-4°F a 158°F)
Material de casco	Helmet Material	High-impact Resistant Plastic/Polyamide (Nylon)
Peso	Total Weight	450 gr



**Protector cristal  
Glass protection**

**Ref**

**1100 028001**



**1**



**5,20**

DELANTAL Y MANGUITOS SOLDADOR PIEL NATURAL 1,5 MM / TABLIER ET MANCHETTES DE SOUDEUR EN PEAU NATURELLE 1.5 MM  
COW LEATHER APRON AND COW LEATHER SLEEVE FOR WELDING 1,5 MM / GEMBRIULE IN PELLE E PROTEZIONE BRACCIA IN PELLE PER SALDATORI 1,5 MM  
AVENTAL E MANGAS PARA SOLDAGEM PELE NATURAL 1,5 MM



**Ref**

**1100 0211**



**1,5 mm**



**1**



**23,60**



**Ref**

**1100 0212**



**1,5 mm**



**1 par**



**20,25**



CLASIFICACIÓN DE FILTROS DE PROTECCIÓN CONTRA PARTÍCULAS Y AEROSOLES.  
CLASSIFICATION DES FILTRES DE PROTECTION CONTRE LES PARTICULES ET LES AÉROSOLS.  
CLASSIFICATION OF RESPIRATORS AGAINST SOLID AND LIQUID AEROSOLS.  
CLASSIFICAZIONE DEI FILTRI PER LA PROTEZIONE CONTRO LE PARTICELLE E GLI AEROSOL.  
CLASSIFICAÇÃO DE RESPIRADORES CONTRA PARTÍCULAS E AEROSOLES.

### FFP1 (D)

- ES Las mascarillas FFP1D están indicadas para la protección contra partículas sólidas y líquidas según la norma EN 149:2001. Son idóneas para la protección contra materiales perjudiciales no tóxicos en concentraciones de hasta 4xOEL o 4xAPF. OEL: Límite de exposición laboral. APF: Factor de protección asignado. (D) Test dolomita para una respiración más confortable.
- FR Les masques FFP1D sont indiqués dans la protection contre les particules et liquides d'après la norme EN 149:2001. Ils constituent une protection contre les matériaux préjudiciables non toxiques dans des concentrations allant jusqu'à 4xOEL ou 4xAPF. OEL: Limite d'exposition au travail. APF: Facteur de protection assigné. (D) Test dolomite pour une respiration plus confortable.
- EN Particulate respirators FFP1D are approved for use against solid and liquid aerosols according to EN 149:2001. They are suitable for protection against non-toxic harmful materials in concentrations up to 4xOEL or 4xAPF. OEL: Occupational exposure limit. APF: Assigned protection factor. (D) Optional dolomite clogging test for more comfortable breathing.
- IT Le mascherine FFP1D sono idonee per la protezione contro particelle solide e liquide. Secondo la norma EN 149: 2001. Sono idonee per la protezione contro materiali pericolosi non tossici in concentrazioni fino a 4xOEL o 4xAPF. OEL: Limite di esposizione all'agente nocivo. (D) Test dolomite per una respirazione più confortevole.
- PT As máscaras FFP1D são recomendadas para a proteção contra partículas sólidas e líquidas de acordo com a norma EN 149:2001. São adequadas para a proteção contra materiais prejudiciais não tóxicos em concentrações até 4xOEL ou 4xAPF. OEL: Limites de Exposição Ocupacional. APF: Fator de proteção atribuído. (D) Teste dolomítico para respiração mais confortável.

### FFP2 (D)

- ES Las mascarillas FFP2D están indicadas para la protección contra partículas sólidas y líquidas según la norma EN 149:2001. Son idóneas para la protección contra materiales perjudiciales de baja a media toxicidad en concentraciones de hasta 12xOEL o 10xAPF. OEL: Límite de exposición laboral. APF: Factor de protección asignado. (D) Test dolomita para una respiración más confortable.
- FR Les masques FFP2D sont indiqués dans la protection contre les particules et les liquides d'après la norme EN 149:2001. Ils constituent une protection contre les matériaux préjudiciable de faible à moyenne toxicité dans des concentrations allant jusqu'à 12xOEL ou 10xAPF. OEL: Limite d'exposition au travail. APF: Facteur de protection assigné. (D) Test dolomite pour une respiration plus confortable.
- EN Particulate respirators FFP2D are approved for use against solid and liquid aerosols according to EN 149:2001. They are suitable for protection against low-to-average toxicity harmful materials in concentrations up to 12xOEL or 10xAPF. OEL: Occupational exposure limit. APF: Assigned protection factor. (D) Optional dolomite clogging test for more comfortable breathing.
- IT Le mascherine FFP2D sono indicate per la protezione contro particelle solide e liquide, secondo la norma EN 149:2001. Sono idonee per la protezione contro materiali pericolosi di bassa e media tossicità in concentrazioni fino a 12xOEL o 10xAPF. OEL: Limite di esposizione all'agente nocivo. APF: Fattore di protezione assegnato. (D) Test dolomite per una respirazione più confortevole.
- PT As máscaras FFP2D são recomendadas para a proteção contra partículas sólidas e líquidas de acordo com a norma EN 149:2001. São adequadas para a proteção contra materiais prejudiciais de baixa e média toxicidade em concentrações até 12xOEL ou 10xAPF. OEL: Limites de Exposição Ocupacional. APF: Fator de proteção atribuído. (D) Teste dolomítico para respiração mais confortável.

### FFP3 (D)

- ES Las mascarillas FFP3D están indicadas para la protección contra partículas sólidas y líquidas según la norma EN 149:2001. Son idóneas para la protección contra materiales perjudiciales altamente tóxicos en concentraciones de hasta 50xOEL o 20xAPF. OEL: Límite de exposición laboral. APF: Factor de protección asignado. (D) Test dolomita para una respiración más confortable.
- FR Les masques FFP3D sont indiqués dans la protection contre les particules et liquides d'après la norme EN 149:2001. Ils constituent une protection contre les matériaux préjudiciables hautement toxiques dans des concentrations allant jusqu'à 50xOEL ou 20xAPF. OEL: Limite d'exposition au travail. APF: Facteur de protection assigné. (D) Test dolomite pour une respiration plus confortable.
- EN Particulate respirators FFP3D are approved for use against solid and liquid aerosols according to EN 149:2001. They are suitable for protection against high toxicity harmful materials in concentrations up to 50xOEL or 20xAPF. OEL: Occupational exposure limit. APF: Assigned protection factor. (D) Optional dolomite clogging test for more comfortable breathing.
- IT Le mascherine FFP3D sono indicate per la protezione contro particelle solide e liquide, secondo la norma EN 149:2001. Sono idonee per la protezione contro materiali pericolosi altamente tossici concentrazioni fino a 50xOEL o 20xAPF. OEL: Limite di esposizione all'agente nocivo. APF: Fattore di protezione assegnato. (D) Test dolomite per una respirazione più confortevole.
- PT As máscaras FFP3D são recomendadas para a proteção contra partículas sólidas e líquidas de acordo com a norma EN 149:2001. São adequadas para a proteção contra materiais prejudiciais altamente tóxicos em concentrações até 50xOEL ou 20xAPF. OEL: Limites de Exposição Ocupacional. APF: Fator de proteção atribuído. (D) Teste dolomítico para respiração mais confortável.



MASCARILLA TEXTIL REUTILIZABLE / MASQUE TEXTILE RÉUTILISABLE / REUSABLE CLOTH FACE MASK  
 MASCHERINA REUTILIZZABILE / MÁSCARA TEXTIL REUTILIZÁVEL



EN 14683:2019 + A1:2009  
 MI 170 Y MI 171



LAVABLE HASTA 25 VECES  
 WASHABLE UP TO 25 TIMES



LAVABLE HASTA 50 VECES  
 WASHABLE UP TO 50 TIMES



RETENCIÓN DE PARTÍCULAS 94,2%  
 BACTERIAL FILTRATION EFFICIENCY OF 94,2%



RETENCIÓN DE PARTÍCULAS 95%  
 BACTERIAL FILTRATION EFFICIENCY OF 95%



ES **SEGURIDAD CERTIFICADA**

- SEGÚN LA CATEGORÍA 2  
 Hasta 4 horas de uso.  
 - 3 CAPAS DE PROTECCIÓN  
 Elaborada en poliéster en el exterior y textil no tejido y poliéster en el interior.

FR **SÉCURITÉ CERTIFIÉE**

- SELON LA CATÉGORIE 2  
 Jusqu'à 4 heures d'utilisation.  
 - 3 COUCHES DE PROTECTION  
 Les deux couches extérieures du masque sont en polyester, la couche intérieure est en tissu non tissé.

EN **CERTIFIED SAFETY**

- ACCORDING TO TYPE II  
 Ensuring 4 hours of safe use.  
 - PROTECTIVE 3 PLY CONSTRUCTION  
 External and internal layer made of polyester, meanwhile the inner layer is made of non-woven fabric.

IT **SICUREZZA CERTIFICATA**

- SECONDO LA CLASSE 2  
 Può essere utilizzata fino a 4 ore.  
 3 STRATI DI TESSUTO:  
 Strato sterno in poliestere, lo strato intermedio è realizzato in tessuto non tessuto e lo strato interno è anche in poliestere.

IT **SICUREZZA CERTIFICATA**

- DE ACORDO COM A CATEGORIA 2  
 Até 4 horas de uso.  
 - 3 CAMADAS DE PROTEÇÃO  
 As duas camadas externas da máscara estão fabricadas em poliéster, enquanto que a interior é de tela não tecida.

ES **MÁXIMO CONFORT**

- FÁCIL COLOCACIÓN  
 Los elásticos hacen que el uso de esta mascarilla sea más fácil y práctico.

FR **CONFORT MAXIMUM**

- PLACEMENT FACILE  
 Les élastiques rendent l'utilisation de ce masque plus facile et plus pratique.

EN **MAXIMUM USER CONVENIENCE**

- EASY FITTING  
 The ear loops make the use of this mask easier and more useful.

IT **MASSIMO CONFORT**

- FACILE DA INDOSSARE  
 Gli elastici rendono l'uso di questa maschera più facile e pratico.

PT **MÁXIMO CONFORTO**

- FÁCIL COLOCAÇÃO  
 Os elásticos fazem com que o uso desta máscara seja mais fácil e prático.

ES **MEMBRANA ANTIVAHO**

Esta membrana, junto con una pinza nasal situada en la parte superior de la mascarilla, impide el paso del aire para evitar el empañamiento de las gafas.

ES **MEMBRANE ANTI BUEE**

Cette membrane, associée à une pince nasale située dans la partie supérieure du masque, empêche le passage de l'air pour éviter la formation de buée sur les lunettes.

ES **ANTI-FOG MEMBRANE**

This membrane, together with a mouldable nose bridge located on the top of the mask, prevents escaping warm breath through the top edges.

ES **MEMBRANA ANTIAPPANNAMENTO**

Questa membrana, insieme al ponticello nasale flessibile posto sulla mascherina, impedisce la fuoriuscita di alito caldo attraverso i bordi superiori della stessa mascherina.

ES **MEMBRANA ANTI-EMBACIAMENTO**

Esta membrana, junto con a pinça nasal situada na parte superior da máscara, impede a passagem do ar para evitar o embaciamento dos olhos.

ADULTO

NIÑO

Ref			
1100 0415		1	7,45
1100 0415-AM		1	7,99
1100 0415-AZ		1	7,99
1100 0415-BL		1	7,99
1100 0415-GR		1	7,99
1100 0415-R		1	7,99
1100 0415-N		1	7,45



**PROTECCIÓN RESPIRATORIA / PROTECTION RESPIRATOIRE / RESPIRATORY PROTECTION  
PROTEZIONE DELLE VIE RESPIRATORIE / PROTEÇÃO RESPIRATÓRIA**



CAJA DE 50 MASCARILLAS QUIRÚRGICAS DESECHABLES CON 3 CAPAS / BOITE DE 50 MASQUES CHIRURGICAUX JETABLES AVEC 3 COUCHES  
BOX OF 50 DISPOSABLE SURGICAL FACE MASKS WITH 3 LAYERS / PACCHETTO DI 50 MASCHERINE MONOUSO A 3 STRATI  
CAIXA 50 UNIDADES MÁSCARA QUIRÚRGICA DESCARTÁVEL 3 CAMADAS



- 1 **LAVARSE LAS MANOS**  
LAVAR AS MÃOS
- 2 **TIRE DE LAS GOMAS HACIA LA CABEZA**  
PUXE OS ELÁSTICOS PARA AS ORELHAS
- 3 **PRESIONE LA TIRA METÁLICA**  
PRESIONE A TIRA DE METAL
- 4 **GARANTÍA DE PROTECCIÓN**  
GARANTIA DE PROTEÇÃO

**3** capas  
lapas

**50**  
unidades  
unidades

**UNE 14683:2019 + AC**  
**CLASE 2**

- ES Alto B.F.E y P.F.E. filtración. Apto para piel sensible. Ajuste cómodo y respiración fácil. Goma para la oreja de alta elasticidad.
- FR Haut B.F.E. et P.F.E. filtration. Convient aux peaux sensibles. Coupe confortable et respiration facile. Élastiques pour les oreilles de haute élasticité.
- EN High BFE and PFE. Suitable for sensitive skin. Comfortable fit and excellent breathability. High elastic ear loops.
- IT Alta BFE e PFE. Adatta per pelle sensibile. Facile da indossare e buona traspirabilità. Elastici ad alta elasticità.
- PT Alto filtro B.F.E. e P.F.E. Ideal para pele sensível. Um ajuste comodo e fácil respiração. Elástico para as orelhas com alta elasticidade.

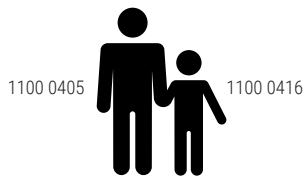

**Infantil / For kids**

**Sin tintes / No colourings**  
**Talla única universal / One-size-fits-all**  
**Elástico para ajustarse a las orejas / Elastic ear loop**

Ref			
1100 0405	1	50	1,23
1100 0416	1	50	1,23

MASCARILA FFP2 PLEGABLE SIN VÁLVULA / MASQUE PLIABLE FFP2 SANS VALVE / FOLDABLE FFP2 SAFETY MASKS WITHOUT VALVE  
MASCHERINA PROTETTIVA FFP2 SENZA VALVOLA PIEGHEVOLE / MÁSCARA FFP2 DESDOBRÁVEL



**40 und.**  
**20 Packs**

- USO INDIVIDUAL**  
SINGLE USE
- LEA LAS INSTRUCCIONES**  
READ THE INSTRUCTIONS
- < 80%**
- 10°C - +40°C**

**EN 149:2001 + A1:2009**  
**CAT III FFP2 NR**

- ES Diseño de contorno 3D. Plegable verticalmente. Clip ajustable a la nariz para optimizar el ajuste. Bandas elásticas soldadas por ultrasonidos. Ideal para utilizarla durante todo el día. Filtración del 95 % proporcionando una protección antibacteriana y antipolvo.
- FR Design contour 3D. Pliage vertical. Pince-nez réglable pour optimiser l'ajustement. Bandes élastiques soudées par ultrasons. Idéal pour une utilisation tout au long de la journée. 95% de filtration offrant une protection antibactérienne et anti-poussière.
- EN 3D wrinkles design. Foldable. Adjustable nose clip for a comfortable fit. Ultrasonic welded ear loops. It can be worn all day long. Filtering efficiency up to 95% by providing protection against dust and bacteria
- IT Concezione del profilo in 3D. Design pieghevole. Clip nasale regolabile per offrire una copertura completa. Elastici saldati ad ultrasuoni. Adatto per utilizzare per tutto il giorno. Efficacia di filtrazione al 95% e offre una protezione antibatterica e contro la polvere.
- PT Desenho de contorno 3D. Desdobrável verticalmente. Clip ajustável para o nariz para otimizar o ajuste. Elásticos soldados por ultrasons. Ideal para usar durante todo o dia. Filtragem de 95%, proporcionando proteção antibacteriana e anti-pó.

Protección 360°  
360° protection

Filtro electrostático para facilitar la respiración.  
Electrostatic filter for easy breathing.

Adaptable anatómicamente para bloqueo eficiente de la entrada de partículas.  
Anatomically adaptable mask intended for avoiding the entrance of solid particles.

Espacio transpirable 3D.  
3D breathing space.



Ref		
1100 0407	40	4,70
1100 0407-U	Pack 2 uds	10,50



MASCARILLA HIGIÉNICA PARA POLVO GRUESO Y FINO / MASQUE HYGIÉNIQUE POUR POUSSIÈRES FINES-GRASSES  
 HYGIENIC MASK FOR THICK AND THIN DUST / MASCHERINA IGIENICA PER POLVERI GROSSE E FINI  
 MÁSCARA HIGIÉNICA PARA PÓ GROSSO E FINO



Ref		
1100 0060	50	0,32

MASCARILLA FFP1D / MASQUE FFP1D / FFP1D PARTICULATE RESPIRATOR / MASCHERINA FFP1D / MÁSCARA FFP1D



**CE**  
**FFP1 NR (D)**  
**EN149: 2001 + A1: 2009**  
**CAT III**



ES Test dolomita aprobado.  
 FR Test dolomite approuvé.  
 EN Dolomite clogging test approved.  
 IT Test dolomite superato.  
 PT Teste dolomita aprovado.

Ref					
1100 0101			20	1,13	
1100 0101BL	SET 3 PCS	1	12	5,47	✓

MASCARILLA FFP1D / MASQUE FFP1D / FFP1D PARTICULATE RESPIRATOR / MASCHERINA FFP1D / MÁSCARA FFP1D



**CE**  
**FFP1 NR (D)**  
**EN149: 2001 + A1: 2009**  
**CAT III**



ES Test dolomita aprobado.  
 FR Test dolomite approuvé.  
 EN Dolomite clogging test approved.  
 IT Test dolomite superato.  
 PT Teste dolomita aprovado.

Ref				
1100 0062		20	1,22	

MASCARILLA FFP2D / MASQUE FFP2D / FFP2D PARTICULATE RESPIRATOR / MASCHERINA FFP2D / MÁSCARA FFP2D



**CE**  
**FFP2 NR (D)**  
**EN149: 2001 + A1: 2009**  
**CAT III**



ES Test dolomita aprobado.  
 FR Test dolomite approuvé.  
 EN Dolomite clogging test approved.  
 IT Test dolomite superato.  
 PT Teste dolomita aprovado.

Ref					
1100 0102			10	5,25	
1100 0102BL	Set 2 pcs	1	12	6,08	✓



MASCARILLA FFP2D / MASQUE FFP2D / FFP2D PARTICULATE RESPIRATOR / MASCHERINA FFP2D / MÁSCARA FFP2D



**FFP2 NR (D)**  
**EN149: 2001 + A1: 2009**  
**CAT III**



ES Test dolomita aprobado.  
 FR Test dolomite approuvé.  
 EN Dolomite clogging test approved.  
 IT Test dolomite superato.  
 PT Teste dolomita aprovado.

Ref				
1100 0061		20	5,90	
1100 0061BL	1	12	2,66	✓

MASCARILLA PROTECCIÓN CON VÁLVULA FFP2 NR / MASQUE PROTEC. AVEC VALVE FFP2 NR / CONICAL RESPIRATOR WITH VALVE FFP2 NR  
 MASCHERA PROTEZIONE CON VALVOLA FFP2 NR / MÁSCARA PROTEÇ. C/VÁLVULA FFP2 NR



**FFP2 (ND)**  
**EN149: 2001 + A1: 2009**  
**CAT III**



ES Forro suave de P.P.  
 FR Doublure douce de P.P.  
 EN Smooth P.P. lining.  
 IT Rivestimento morbido in P.P.  
 PT Revestimento suave de P.P.

**Carbono**

Ref		
1100 0234	10	1,75

MASCARILLA CON VÁLVULA CARBONO FFP2D APTA PARA PINTAR, LACAR, LIJAR, ETC. / MASQUE CARBONE AVEC VALVE FFP2D  
 FFP2D VALVED FOLDABLE ACTIVE CARBON RESPIRATOR / MASCHERINA CARBONE CON VALVOLA FFP2D  
 MÁSCARA COM VÁLVULA CARBONO FFP2D APTA PARA PINTAR, LACAR, LIXAR, ETC



**FFP2 NR (D)**  
**EN149: 2001 + A1: 2009**  
**CAT III**



ES Test dolomita aprobado.  
 FR Test dolomite approuvé.  
 EN Dolomite clogging test approved.  
 IT Test dolomite superato.  
 PT Teste dolomita aprovado.

**Carbono**

Ref		
1100 0063	20	4,36

MASCARILLA PROTECCIÓN CON VÁLVULA FFP3 NR / MASQUE PROTEC. AVEC VALVE FFP3 NR / CONICAL RESPIRATOR WITH VALVE FFP3 NR  
 MASCHERA PROTEZIONE CON VALVOLA FFP3 NR / MÁSCARA PROTEÇ. C/VÁLVULA FFP3 NR



**FFP3 (NR)**  
**EN149: 2001 + A1 2009**  
**CAT III**



ES Válvula de exhalación - Extra confort.  
 FR Respiration - Communication facile.  
 EN Easy breathing - Speaking.  
 IT Respirazione - Comunicazione confortevole.  
 PT Respiração - Comunicação fácil.

**Alta Toxicidad**

Ref		
1100 0235	10	3,40





MASCARILLA CON VÁLVULA FFP3D / MASQUE AVEC VALVE FFP3D / FFP3D VALVED PARTICULATE RESPIRATOR  
MASCHERINA CON VALVOLA FFP3D / MÁSCARA COM VÁLVULA FFP3D



**FFP3 NR (D)  
EN149: 2001 + A1 2009  
CAT III**

**Alta Toxicidad**



ES Test dolomita aprobado.  
FR Test dolomite approuvé.  
EN Dolomite clogging test approved.  
IT Test dolomite superato.  
PT Teste dolomita aprovado.

Ref		
1100 0103	5	8,90

MASCARILLA SILICONA DOBLE FILTRO / MASQUE SILICONE DOUBLE FILTRE / SILICONE MASK DOUBLE FILTER  
MASCHERINA SILICONE DOPPIO FILTRO / MÁSCARA DE PROTEÇÃO SILICONE PARA 2 FILTROS



**0099  
EN 140**



ES Filtros no incluidos  
FR Filtres non inclus  
EN Filters not included  
IT Filtri non inclusi  
PT Filtros não incluídos

Ref		
1100 2126	1	22,83

FILTROS TIPO A, B, E, K1 / FILTRES TYPE A, B, E, K1 / FILTERS TYPE A, B, E, K1 / FILTRI TIPO A, B, E, K1 / FILTROS TIPO A, B, E, K1

**0099  
EN 14387: 2004 CLASS1**



**0099  
EN 143/A1**

**SET 8 PCS**

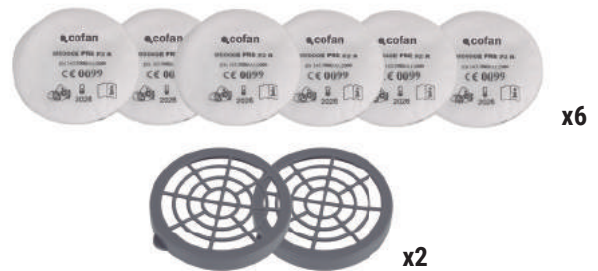

Ref		
1100 2128	1	14,87

Ref		
1100 2127	1 set	20,11

Tipos de Filtración Filtration Types	TIPOS DE PROTECCIÓN PROTECTION TYPES
TIPO A1	Contra los gases y vapores orgánicos con el punto de ebullición > a 65°C (solventes e hidrocarburos) Contre les gaz et vapeurs organiques dont le point d'ébullition est > à 65°C (solvants et hydrocarbures) Protects from organic gases and vapours whose boiling point is > 65°C (solvents and hydrocarbons) Contro i gas e i vapori organici quando il punto di ebollizione è > di 65°C (solventi e idrocarburi) Contra os gases e vapores orgânicos com o ponto de ebulição > 65°C (solventes e hidrocarbonetos)
TIPO B1	Contra gases y vapores inorgánicos, salvo óxido de carbono Contre les gaz et vapeurs inorganiques, sauf l'oxyde de carbone Protects from inorganic gases and vapours, except from carbon monoxide Contro i gas e i vapori inorganici, senza ossido di carbonio Contra os gases e vapores orgânicos, exceto óxido de carbono
Tipos de Filtración Filtration Types	TIPOS DE PROTECCIÓN PROTECTION TYPES
TIPO E1	Contra el dióxido de azufre y algunos gases y vapores ácidos Contre le dioxyde de soufre et certains gaz et vapeurs acides Protects from sulphur dioxide and some acid vapours and gases Contro il diossido di zolfo e certi gas e vapori acidi Protege contra o dióxido de enxofre e de alguns gases e vapores ácidos
TIPO K1	Contra amoníaco y algunos derivados aminados Contre l'ammoniac et certains dérivés aminés Protects from ammoniac and some amine derivatives Contro l'ammoniaca e certi derivati aminici Protege contra o amoníaco e alguns derivados de aminas



CASCOS DE PROTECCIÓN CON REGULADOR / CASQUE D'INGÉNIEUR AVEC RÉGULATEUR / HELMET WITH RACHET NYLON SUSPENSION  
 CASCO DA CANTIERE CON REGOLAZIONE / CAPACETES DE PROTEÇÃO COM REGULADOR



**EN397: 2012 + A1 2012  
 CAT II**

ES Regulador trasero automático / Suspensión en nylon  
 FR Regulateur automatique / Brides en nylon  
 EN Automatic size adjustment / Nylon suspension  
 IT Regolatore automatico / Sospensione in nylon  
 PT Regulador trasero automático / Suspensão em nylon



Ref				
1100 0171		1	40	7,85
1100 0172		1	40	7,85
1100 0173		1	40	7,85
1100 0174		1	40	7,85
1100 0175		1	40	7,85
1100 0213		1	40	8,01

BARBUQUEJO ELÁSTICO PARA CASCO DE OBRA / FISSATORE ELASTICO PER CASQUE D'INGÉNIEUR / ELASTIC ADJUSTABLE CHIN STRAP  
 FISSATORE ELASTICO PER CASCO DA LAVORO / CINTA DE QUEIXO P/CAPACETE DE PROTEÇÃO



Ref		
1100 0189	1	1,98

COQUILLAS ANTI-RUIDO, SNR-23DB  
 COQUILLES ANTI-BRUIT FIXATION, SNR-23DB  
 CAP MOUNTED EARMUFFS, SNR-23DB  
 CUFFIE ANTI-RUMORE, SNR-23DB  
 PROTETOR AUDITIVO, SNR-23DB

**EN352-3: 2002  
 CAT III**



Ref		
1100 0304	1	14,72

PANTALLA DE REJILLA 400 X 200 MM  
 VISIÈRE GRILLAGÉE 400 X 200 MM  
 400 X 200 MM METAL WIRE MESH  
 VISIERA GRIGLIATA 400 X 200 MM  
 VISEIRA MALHA DE ARAME 400 X 200 MM

**EN1731: 2006  
 CAT II**

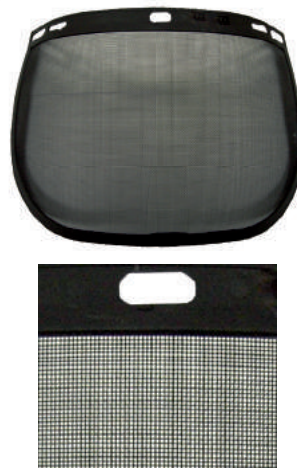

Ref		
1100 0302	1	5,90

SOPORTE DE PLÁSTICO Y PORTA-VISERA  
 SUPPORT DE PLASTIQUE ET VISIÈRE  
 PLASTIC BRACKET AND VISOR  
 STAFFA DI PLASTICA E SUPPORTO VISIERA  
 SUPORTE PLÁSTICO E VISEIRA



Ref		
1100 0301	1	6,03



Ref		
1100 0306	1	1,30

GORRA DE SEGURIDAD SPORT / CASQUETTE DE SÉCURITÉ / SPORTS WORKING CAP / CAPPELLINO DI PROTEZIONE / BONÉ DE PROTEÇÃO

**EN812: 2012  
 CAT II**



ES Diseñada para impactos de baja intensidad, fabricada en ABS. Muy confortable, con orificios de ventilación.  
 FR Conçue pour des impacts de faible intensité, fabriquée en ABS. Tres confortable, orifices de ventilation.  
 EN Designed for light protection against impact with ABS shell and foam spacer. Ventilation holes provides user's comfort.  
 IT Disegnato per impatti di bassa intensità, fabricato in ABS. Molto confortevole e con fori di ventilazione.  
 PT Concebido para impactos de baixa intensidade, fabricado em ABS. Muito confortável, com orificios para ventilação.

Ref				
1100 0196		1	5	13,26



**PROTECCIÓN AUDITIVA / PROTECTION AUDITIVE / EAR PROTECTION  
PROTEZIONE DELL'UDITO / PROTEÇÃO AUDITIVA**



PACK TAPONES P/OÍDOS PU SNR 36DB / PACK BOUCHONS D'OREILLES PU SNR 36DB / PACK EAR PLUGS PU SNR 36DB  
CONFEZIONE DA TAPI PER ORECCHIE PU SNR 36DB / EMBALAGEM TAMPOES P/ OUVIDOS PU SNR 36DB



**CE EN352-2: 2002  
CAT III**

Ref						x pack	
1100 0379		50 pcs	1 pack	36	12,02		
1100 0379BL		10 pcs	1 pack	20	2,40		✓

PACK TAPONES P/OÍDOS CON CUERDA PU SNR 36DB / PACK BOUCHONS D'OREILLES AVEC CORDON PU SNR 36DB  
PACK EAR PLUGS WITH CORD PU SNR 36DB / CONFEZIONE DA TAPI PER ORECCHIE CON CORDINO PU SNR 36DB  
EMBALAGEM TAMPOES P/ OUVIDOS C/ CORDA PU SNR 36DB



**CE EN352-2: 2002  
CAT III**

Ref						x pack	
1100 0380		50 pcs	1 pack	36	18,03		
1100 0380BL		10 pcs	1 pack	20	3,60		✓

CASCOS ANTI-RUIDO, SNR-27DB / CASQUES ANTIBRUIT, SNR-27DB / EARMUFFS, SNR-27DB  
CUFFIE ANTIRUMORE, SNR-27DB / CAPACETES ANTI-RUÍDO, SNR-27DB



**CE  
EN352-1: 2002  
CAT III  
SNR-27DB**

Ref				
1100 0041	1	10	8,08	
1100 0041BL	1	6	8,79	✓

CASCOS ANTI-RUIDO, SNR-30DB / CASQUES ANTIBRUIT, SNR-30DB / EARMUFFS, SNR-30DB  
CUFFIE ANTIRUMORE, SNR-30DB / CAPACETES ANTI-RUÍDO, SNR-30DB



**CE  
EN352-1: 2002  
CAT III  
SNR-30DB**

Ref				
1100 0039	1	10	12,07	
1100 0039BL	1	6	13,00	✓

CASCO ANTIRUIDO CAT-III CE SNR 32DB SÚPER LIGERO / CASQUE ANTI-BRUIT CAT-III CE SNR 32DB SUPER LÉGER  
SUPER LIGHTWEIGHT NOISE REDUCTION EARMUFFS CAT-III CE SNR 32DB / CUFFIE ANTIRUMORE SUPER LEGGERI CAT-III CE SNR 32DB  
AURICULARES DE PROTEÇÃO AUDITIVA CAT-III CE SNR 32DB SUPER LEVES



**CE  
EN352-1: 2002  
CAT III  
SNR-32dB**

ES Protector auditivo tipo "copa". Diadema acolchada resistente a la flexión continua.  
FR Protecteur auditif de type "coupe". Bandeau rembourré résistant à la flexion continue.  
EN Hearing protection with cup design. Padded headband, resistant to continuous bending.  
IT Cuffie antirumore con design a coppa. Protettore con archetto imbottito resistente alla flessione continua.  
PT Protetor auditivo tipo «copa». Banda alcochoada resistente á flexão contínua.

Ref				
1100 0398	1	1	9,95	✓





ARNÊS ANTICAÍDAS 2 PUNTOS DE ENGANCHE / HARNAIS ANTI CHUTE 2 POINTS D ATTACHE / SAFETY HARNESS WITH 2 ATTACHMENT POINTS  
IMBRAGATURA ANTICADUTA 2 PUNTI DI AGGANCIAMENTO / ARNÊS ANTI-QUEDA 2 PONTOS DE ENGATE



Esternal  
Dorsal

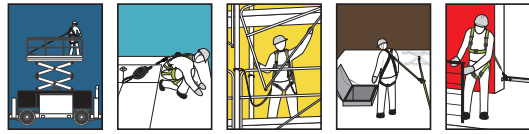

CE EN361: 2002  
EN358: 1999  
CAT III

- ES Muslos ajustables y correa de asiento idónea para una mayor comodidad y ergonomía. Hombros y muslos diferenciados en dos colores. Correa de asiento en posición idónea para mayor comodidad del usuario. Dos puntos de enganche: esternal/dorsal.
- FR Cuisses réglables et ceinture de l'assise conçue pour confort et ergonomie. Épaules et cuisses différenciées par deux couleurs. Ceinture de l'assise conçue dans une position appropriée au confort de l'utilisateur. Deux points d'ancrage: sternal/dorsal.
- EN Adjustable thighs and seat strap for greater comfort and ergonomics. Dual-colour straps to differentiate shoulders from thighs. Seat strap for greater comfort and ergonomics. Two attachment points: chest/dorsal.
- IT Cosciali regolabili e cintura di sicurezza in posizione ideale per un maggior comfort. Cosciali e bretelle differenziati in due colori per una rapida identificazione. Cintura di sicurezza in una posizione ideale per un maggior comfort. Due punti di aggancio: sternale/dorsale.
- PT Coxas ajustáveis e cinto de assento ideal para maior conforto e ergonomia. Ombros e coxas diferenciados em duas cores. "Cinto de segurança na posição ideal para maior conforto do usuário." Dois pontos de engate: esternal/dorsal.

Ref	max		
1100 0032	140 kg	1	33,50

CONJUNTO ARNÊS 2 PTOS+CUERDA+MOSQUETÓN / SET HARNAIS 2 PTS+CORDE+MOUSQUETON / HARNESS+HOOK+SAFETY LINE SET  
KIT IMBRAGATURA 2 PUNTI + CORDA + MOSCHETTONE / CONJUNTO ARNÊS+CORDA+ 2 MOSQUETOES



Esternal  
Dorsal

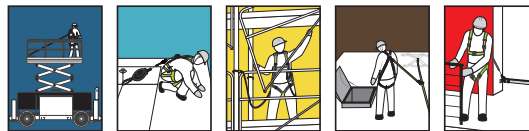

CE EN361: 2002  
CAT III

CE EN354: 2010

CE EN362: 2004  
Class B



- ES Muslos ajustables y correa de asiento idónea para una mayor comodidad y ergonomía. Hombros y muslos diferenciados en dos colores. Correa de asiento en posición idónea para mayor comodidad del usuario. Dos puntos de enganche: esternal/dorsal. Incluye: 1 arnés 2 puntos (Ref. 1100 0032), 1,5 m de cuerda diámetro Ø12 mm con resistencia a la rotura 22kN (Ref. 1100 0033), 2 mosquetones de acero de bloqueo con tornillo (Ref. 1100 0035), 1 Mochila.
- FR Cuisses réglables et ceinture de l'assise conçue pour confort et ergonomie. Épaules et cuisses différenciées par deux couleurs. Ceinture de l'assise conçue dans une position appropriée au confort de l'utilisateur. Deux points d'ancrage: sternal/dorsal. Inclut: 1 Harnais 2 points (Ref 1100 0032), 1,5 m de corde de diamètre Ø12 mm, avec résistance à la rupture 22kN (Ref 1100 0033), 2 mousquetons en acier de blocage avec vis (Ref 1100 0035), 1 sac à dos.
- EN Adjustable thighs and seat strap for greater comfort and ergonomics. Dual-colour straps to differentiate shoulders from thighs. Seat strap for greater comfort and ergonomics. Two attachment points: chest/dorsal. Includes: 1 harness 2 attachment points (Ref 1100 0032), 1,5 m safety line (Ø12 mm diameter) and breaking strength 22kN (Ref 1100 0033), 2 steel locking karabiners with thread (Ref 1100 0035), 1 backpack.
- IT Cosciali regolabili e cintura di sicurezza in posizione ideale per un maggior comfort. Cosciali e bretelle differenziati in due colori per una rapida identificazione. Cintura di sicurezza in una posizione ideale per un maggior comfort. Due punti di aggancio: sternale/dorsale. Include: 1 imbracatura 2 punti (Rif. 1100 0032), 1,5 m di corda con diametro Ø12 mm, con resistenza alla rottura di 22kN (Rif. 1100 0033), 2 moschettoni di bloccaggio in acciaio con vite. Rif. 1100 0035, 1 Sacca.
- PT Coxas ajustáveis e cinto de assento ideal para maior conforto e ergonomia. Ombros e coxas diferenciados em duas cores. "Cinto de segurança na posição ideal para maior conforto do usuário." Dois pontos de engate: esternal/dorsal. Inclui: 1 Arnês 2 pontos (ref. 1100 0032), 1,5 m de corda diâmetro Ø12 mm com resistência à ruptura 22kN (Ref. 1100 0033), 2 Mosquetões de aço de bloqueio com parafuso (Ref. 1100 0035).

Ref	max		
1100 0036	140 kg	1	47,90





**ARNESES ANTICAÍDAS / HARNAIS ANTI CHUTE / SAFETY HARNESS  
IMBRAGATURA ANTICADUTA / ARNÊS ANTI-QUEDA**



ARNÊS ANTICAÍDAS 2 PUNTOS C/CINTURÓN POS. TRABAJO / HARNAIS ANTI CHUTE S 2 PUNTOS AVEC CEINTURE POS. TRAVAIL  
SAFETY HARNESS 2 POINTS W/WORK POSITIONING BELT / IMBRACATURA ANTICADUTA A 2 PUNTI CON CINTURA, POS. LAVORO  
ARNÊS ANTI-QUEDA 2 PONTOS COM CINTO POS. TRABALHO



Esternal  
Dorsal  
Lateral

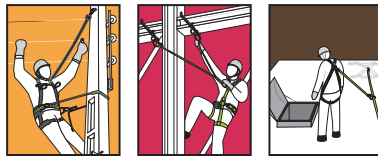

CON CINTURÓN DE POSICIONAMIENTO EN EL TRABAJO  
AVEC CEINTURE POS. TRAVAIL  
WITH WORK POSITIONING BELT  
CON CINTURA, POS. LAVORO  
COM CINTO POS. TRABALHO

CE EN361: 2002  
EN358: 1999  
CAT III

- ES Muslos y cinturón ajustables con correa de asiento idónea para una mayor comodidad. 2 hebillas portaherramientas + 1 anilla portaherramientas en el cinturón para mosquetones y accesorios. Hombros y muslos diferenciados en dos colores.
- FR Cuisses et ceinture réglables avec ceinture de l'assise prévue pour un plus grand confort. 2 boucles porte-outils + 1 anneau porte-outils sur la ceinture pour les mousquetons et les accessoires. Épaules et cuisses différenciées par deux couleurs.
- EN Adjustable thighs and seat strap for greater comfort and ergonomics. 2 buckles for tools + 1 D-ring on the belt for karabiners and accessories. Dual-colour straps to differentiate shoulders from thighs.
- IT Cosciali regolabili e cintura di sicurezza in posizione ideale per un maggior comfort. 2 fibbie portautensili + 1 anello portautensili sulla cintura per moschettoni e accessori. Cosciali e bretelle differenziati in due colori per una rapida identificazione.
- PT Coxas e cinturão ajustáveis com cinto de assento ideal para maior conforto 2 fivelas porta-ferramentas + 1 anel de suporte de ferramenta no cinturão para mosquetões e acessórios. Ombros e coxas diferenciados em duas cores.

Ref	max		
1100 0377	140 kg	1	57,90

ARNÊS ANTICAÍDAS PARA TRABAJO EN SUSPENSIÓN / HARNAIS ANTI CHUTE S POUR TRAVAIL EN SUSPENSION  
SAFETY HARNESS FOR SUSPENSION WORKS / IMBRACATURA ANTICADUTA PER LAVORI IN SOSPENSIONE  
ARNÊS ANTI-QUEDA P/ TRABALHO EM SUSPENSAO



Esternal  
Dorsal  
Lateral  
Ventral



PARA TRABAJOS EN SUSPENSIÓN  
POUR TRAVAIL EN SUSPENSION  
FOR SUSPENSION WORKS  
PER LAVORI IN SOSPENSIONE  
PARA TRABALHO EM SUSPENSAO

CE EN361: 2002  
EN358: 1999  
EN813: 2008  
CAT III

- ES Muslos y cinturón ajustables con correa de asiento idónea para una mayor comodidad. Las cintas de los hombros, muslos y cinturón están equipadas con hebillas de ajuste. 4 hebillas portaherramientas + 3 anillas portaherramientas en el cinturón para mosquetones y accesorios.
- FR Cuisses et ceinture réglables avec ceinture de l'assise prévue pour un plus grand confort. Les liens des épaules, des cuisses et des ceintures sont équipés de boucles d'ajustement. 4 boucles porte-outils + 3 anneaux porte-outils sur la ceinture pour les mousquetons et les accessoires.
- EN Adjustable thighs and seat strap for greater comfort and ergonomics. Shoulder and thigh straps as well as the belt are equipped with adjustable buckles. 4 buckles for tools + 3 D-rings for karabiners and accessories.
- IT Cosciali regolabili e cintura di sicurezza in posizione ideale per un maggior comfort. Cosciali, Bretelle e cintura sono dotate di fibbie regolabili. 4 fibbie portautensili + 3 anelli portautensili nella cintura per moschettoni e accessori.
- PT Coxas e cinturão ajustáveis com cinto de assento ideal para maior conforto. "As fitas dos ombros, coxas e cinturão estão equipadas com fivelas de ajuste. 4 fivelas porta-ferramentas + 3 anéis porta-ferramentas no cinturão para mosquetões e acessórios".

Ref	max		
1100 0378	140 kg	1	135,60



ARNÉS 2 PUNTOS PECHO + 1 DORSAL CON ALTA VISIBILIDAD / HARNAIS 2 POINTS POITRINE + 1 DORSALE AVEC HAUTE VISIBILITÉ  
2-POINT HARNESS ON CHEST & 1-POINT ON THE BACK / IMBRACATURA CON 2 PUNTI DI ANCORAGGIO NEL TORACE E 1 NEL DORSO  
ARNÊS 2 PONTOS PEITO + 1 DORSAL COM ALTA VISIBILIDADE

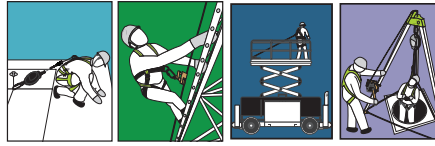

CE EN 361: 2002  
EN 471: 2003 Class 2.2  
CAT III

- ES Arnés anticaída con chaleco de trabajo alta visibilidad amarillo, 2 puntos de enganche. 1 punto de enganche esternal formado por 2 hebillas textiles, 1 argolla en D dorsal para sistema anticaída, 2 bucles automáticos.
- FR Harnais anti-chute avec gilet de travail haute visibilité jaune, 2 points d'accrochage. 1 point d'accrochage sternal composé de 2 boucles textiles, 1 point dorsal D pour système antichute, 2 boucles automatiques.
- EN Fall arrest harness with high visibility yellow vest, 2 attachment points. It is composed of 1 external attachment point consisting of 2 strap buckles, 1 back D-Ring for fall arrest system and 2 automatic buckles.
- IT Imbracatura anticaduta con gilet ad alta visibilità e 2 punti di ancoraggio dorsale. 1 punto di ancoraggio esterno composto da 2 fibbie ad ardiglione, 1 anello di aggancio per il sistema anticaduta e 2 fibbie autobloccanti.
- PT Arnês anticaída com colete de trabalho amarelo com alta visibilidade, 2 pontos de engate. 1 ponto de gancho esternal composto por 2 fivelas têxteis, 1 ponto em D dorsal para sistema de travamento de queda, 2 presilhas automáticas.

Ref	max			
1100 0370	140 kg	1	189,00	✓

CONJUNTO ARNÉS 2 PIEZAS + CUERDA + 2 MOSQUETONES + ABSORBEDOR / JEU DE HARNAIS 2 PIECES + CORDE + 2 MOUSQUETONS + ABSORBEUR  
2-POINT HARNESS WITH ENERGY ABSORBER LANYARD & CARABINERS / IMBRACATURA CON 2 PUNTI DI ANCORAGGIO CON CORDA, MOSCHETTONE E CON ASSORBITORE DI ENERGIA / CONJUNTO ARNÊS DE 2 PEÇAS + CORDA + MOSQUETÕES + ABSORVEDOR



External  
Dorsal



CE EN 361: 2002  
EN 354: 2010  
EN 355: 2002

CE EN 362: 2004  
Class B  
CAT III

12 mm  
25kN  
18 mm

- ES Muslos ajustables y correa de asiento idónea para una mayor comodidad y ergonomía. Hombros y muslos diferenciados en dos colores. Correa de asiento en posición idónea para mayor comodidad del usuario. Dos puntos de enganche: esternal/dorsal. Incluye: 1 arnés 2 puntos, 1,5 m de cuerda diámetro Ø12 mm con resistencia a la rotura 22kN, 2 mosquetones de acero de bloqueo con tornillo, 1 Mochila. Absorbedor energía.
- FR Cuisses réglables et ceinture de l'assise conçue pour confort et ergonomie. Épaules et cuisses différenciées par deux couleurs. Ceinture de l'assise conçue dans une position appropriée au confort de l'utilisateur. Deux points d'ancrage: sternal/dorsal. Inclut: 1 Harnais 2 points, 1,5 m de corde de diamètre Ø12 mm, avec résistance à la rupture 22kN, 2 mousquetons en acier de blocage avec vis, 1 sac à dos.
- EN Adjustable thighs and seat strap for greater comfort and ergonomics. Dual-colour straps to differentiate shoulders from thighs. Seat strap for greater comfort and ergonomics. Two attachment points: chest/dorsal. Includes: 1 harness 2 attachment points, 1,5 m safety line (Ø12 mm diameter) and breaking strength 22kN, 2 steel locking karabiners with thread, 1 backpack.
- IT Cosciali regolabili e cintura di sicurezza in posizione ideale per un maggior comfort. Cosciali e bretelle differenziati in due colori per una rapida identificazione. Cintura di sicurezza in una posizione ideale per un maggior comfort. Due punti di aggancio: sternale/dorsale. Include: 1 imbracatura 2 punti, 1,5 m di corda con diametro Ø12 mm, con resistenza alla rottura di 22kN, 2 moschettoni di bloccaggio in acciaio con vite, 1 Sacca.
- PT Coxas ajustáveis e cinto de assento ideal para maior conforto e ergonomia. Ombros e coxas diferenciados em duas cores. "Cinto de segurança na posição ideal para maior conforto do usuário." Dois pontos de engate: esternal/dorsal. Inclui: 1 Arnês 2 pontos, 1,5 m de corda diâmetro Ø12 mm com resistência à ruptura 22kN, 2 Mosquetões de aço de bloqueio com parafuso.



Ref	max			
1100 0385	140 kg	1	71,55	



**ARNESES ANTICAÍDAS / HARNAIS ANTI CHUTE / SAFETY HARNESS  
IMBRAGATURA ANTICADUTA / ARNÊS ANTI-QUEDA**



**CUERDA DE POSICIONAMIENTO CON AJUSTADOR + MOSQUETONES / CORDE POSITIONNEMENT AVEC RÉGLEUR + MOUSQUETONS  
POSITIONING ROPE WITH ADJUSTER & CARABINERS / CORDA DI POSIZIONAMENTO REGOLABILE CON MOSCHETTONE  
CORDA DE POSICIONAMENTO COM AJUSTADOR + MOSQUETÕES**



**CE EN 358: 1999  
CAT III**

ES Eslinga de cuerda torcida de posicionamiento en el trabajo con hebilla y reductor, longitud máxima 2 m, con 1 mosquetón de acero de bloqueo y 1 mosquetón de acero de bloqueo automático de doble acción.

FR Elingue en corde torsadée pour le maintien au travail avec boucle avec réducteur, longueur maximale 2 m, avec 1 mousqueton à verrouillage en acier avec vis et 1 mousqueton à verrouillage automatique en acier à double action.

EN Work Positioning Twisted Rope Lanyard with buckle and reducer, 1 steel carabiner with screw lock, maximum length 2m, and 1 double action auto-locking steel carabiner.

IT Imbracatura di corda intrecciata di posizionamento sul lavoro con fibbia e riduttore, lunghezza massima di 2m con 1 moschettone in acciaio con ghiera di bloccaggio a vite e 1 moschettone in acciaio di blocco automatico a doppia azione.

PT Corda de vida trançada para posicionamento com fivela e redutor, comprimento máximo de 2 m, com 1 mosquetão de bloqueio em aço com parafuso e 1 mosquetão de aço com travão automático de dupla ação.

**Min - Max**

Ref	↔	∅	📦	📊	📄
<b>1100 0381</b>	1,2 m - 2,0 m	14 mm	1	<b>32,35</b>	✓

**ROLLO DE CUERDA PARA TRABAJOS EN ALTURA / CORDE ROULEAU TRAVAIL EN HAUTEUR / ROLL OF ROPE FOR WORKS AT HEIGHT  
ROTOLO DI CORDA PER LAVORI IN QUOTA / ROLO DE CORDA PARA TRABALHOS EM ALTURA**

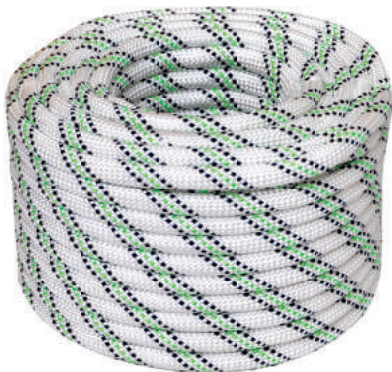

**CE EN 1891: 1999  
CAT III**

ES Cuerda trenzada semiestática, diámetro 12 mm.

FR Corde tressée semi-statique, diamètre 12 mm.

EN Semi-synthetic braided rope with a diameter of 12mm.

IT Corda intrecciata semisintetica con 12mm di diametro.

PT Corda trançada semi-estática, diámetro 12mm.

Ref	↔	∅	📦	📊
<b>1100 0387</b>	25 m	12 mm	1	<b>103,50</b>
<b>1100 0388</b>	50 m	12 mm	1	<b>202,50</b>

**CINTURÓN DE SEGURIDAD PARA TRABAJOS DE POSICIONAMIENTO 140KG / CEINTURE DE SÉCURITÉ POSITIONNEMENT DE 140 KG  
POSITIONING SAFETY BELT FOR WORK POSITIONING 140KG / CINTURA DI POSIZIONAMENTO 140KG  
CINTO DE SEGURANÇA DE POSICIONAMENTO 140KG**



**CE EN 358: 1999  
CAT III**

ES Cinturón de sujeción/ posicionamiento durante el trabajo "confort" con 2 anillas en D laterales.

FR Ceinture de maintien / positionnement pendant le travail "confort" avec 2 anneaux en D latéraux.

EN Positioning belt can be used during work for comfort, with 2 side D-rings.

IT Cintura di posizionamento che può essere usata durante l'attività lavorativa con 2 anelli a D in acciaio.

PT Cinto de apoio / posicionamento "confort" durante o trabalho com 2 anilhas em D laterais.

Ref	max	📦	📊
<b>1100 0389</b>	140 kg	1	<b>30,60</b>



ANTICAÍDA RETRÁCTIL 7 M CON ABSORBEDOR / ANTI CHUTE RÉTRACTILE 7 M AVEC ABSORBEUR / RETRACTABLE FALL ARREST 7 M W/ SHOCK ABSORBER  
ANTICADUTA REATRATTILE 7 M CON AMMORTIZZATORE / ANTI-QUEDA REATRÁTIL 7 M COM AMORTECEDOR

**Kg**  
3.44

7 m

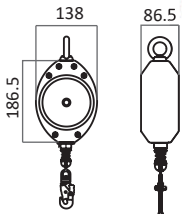

Testigo de caída  
Témoïn de chute  
Load indicator  
Indicatore di caduta  
Indicador de queda

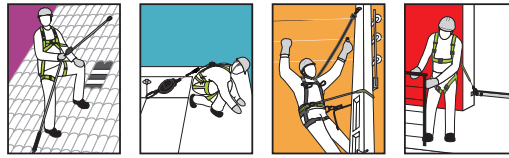
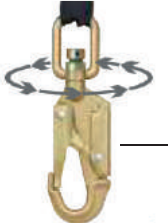

**OK** Aristas vivas con absorbedor de energía integrado.  
Arêtes vives avec absorbeur d'énergie intégré.  
Sharp edges with shock absorber included.  
Spigoli vivi con assorbitore di energia integrato.  
Arestas vivas com absorvedor de energia integrado.

**CE EN360: 2002  
CAT III**

- ES Carcasa de polímero de alta resistencia, con cable de acero galvanizado Ø4,5 mm en el cable. Sistema de freno con fuerza de impacto inferior a 6 kN. Incluye absorbedor de energía (Rev. 08 - 10/2014). Resistencia: > 12kN.
- FR Carcasse en polymère de haute résistance, avec câble en acier galvanisé Ø4,5 mm dans le câble. Système de frein avec force d'impact inférieur à 6 kN. Inclut absorbeur d'énergie (Rev. 08 - 10/2014). Résistance: > 12kN.
- EN High resistant polymer case, with Ø4.5 mm galvanised steel wire. Brake system with shock resistance lower than 6 kN. It includes shock absorber (Rev. 08 - 10/2014). Resistance: > 12kN.
- IT Struttura in polimero ad alta resistenza, con cavo in acciaio zincato Ø4,5 mm. Sistema di arresto con forza di impatto inferiore a 6kN. "Include assorbitore di energia (Rev. 08 - 10/2014)." Resistenza: > 12kN.
- PT Carcaça de polímero de alta resistência, com cabo de aço galvanizado de Ø4,5 mm no cabo. Sistema de freio com força de impacto inferior a 6m kN. "Inclui absorvedor de energia (Rev. 08 - 10/2014)." Resistência: >12kN.

Ref	↔	max	📦	📦
1100 0372	7 m	140 kg	1	368,20

ANTICAÍDA RETRÁCTIL CABLE 10 MTS / ANTI CHUTE RÉTRACTILE CABLE 10 MTS / RETRACTABLE FALL ARREST CABLE 10 M  
ANTICADUTA REATRATTILE, CAVO 10M / ANTI-QUEDA REATRÁTIL CABO 10 M

**Kg**  
4.38

10 m

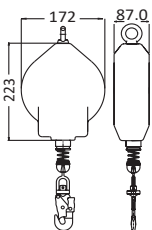

Testigo de caída  
Témoïn de chute  
Load indicator  
Indicatore di caduta  
Indicador de queda

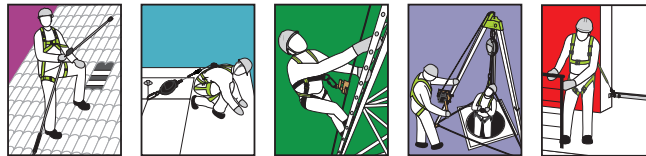

**OK** Aristas vivas con absorbedor de energía integrado.  
Arêtes vives avec absorbeur d'énergie intégré.  
Sharp edges with shock absorber included.  
Spigoli vivi con assorbitore di energia integrato.  
Arestas vivas com absorvedor de energia integrado.

**CE EN360: 2002  
CAT III**

- ES Carcasa de polímero de alta resistencia, con cable de acero galvanizado Ø4,5 mm en el cable. Sistema de freno con fuerza de impacto inferior a 6 kN. Incluye absorbedor de energía. Uso horizontal VG 11.060 (Rev. 08 - 10/2014). Resistencia: > 12kN.
- FR Carcasse en polymère de haute résistance, avec câble en acier galvanisé Ø4,5 mm dans le câble. Système de frein avec force d'impact inférieur à 6 kN. Inclut absorbeur d'énergie. Utilisation horizontale VG 11.060 (Rev. 08 - 10/2014). Résistance: > 12kN.
- EN High resistant polymer case, with Ø4.5 mm galvanised steel wire. Brake system with shock resistance lower than 6 kN. It includes shock absorber. Horizontal use VG 11.060 (Rev. 08 - 10/2014). Resistance: > 12kN.
- IT Struttura in polimero ad alta resistenza, con cavo in acciaio zincato Ø4,5 mm. Sistema di arresto con forza di impatto inferiore a 6kN. "Include assorbitore di energia. Uso orizzontale VG 11.060 (Rev. 08 - 10/2014)." Resistenza: > 12kN.
- PT Carcaça de polímero de alta resistência, com cabo de aço galvanizado de Ø4,5 mm no cabo. Sistema de freio com força de impacto inferior a 6m kN. "Inclui absorvedor de energia. Uso horizontal VG 11.060 (Rev. 08 - 10/2014)." Resistência: >12kN.

Ref	↔	max	📦	📦
1100 0374	10 m	140 kg	1	399,80



**ARNESES ANTICAÍDAS / HARNAIS ANTI CHUTE / SAFETY HARNESS  
IMBRAGATURA ANTICADUTA / ARNÊS ANTI-QUEDA**



ANTICAÍDA RETRÁCTIL CINTA 2,5 MTS / ANTI CHUTE RETACTILE RUBAN 2,5 MTS / RETRACTABLE FALL ARREST TAPE 2.5 M  
ANTICADUTA REATRATTILE, NASTRO 2,5M / ANTI-QUEDA RETRÁTIL FITA 2,5 M

**Kg**  
1.15

2,5 m

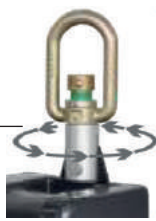

Testigo de caída  
Témoïn de chute  
Load indicator  
Indicatore di caduta  
Indicador de queda

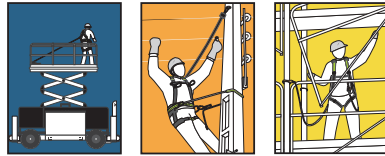

**EN360: 2002  
CAT III**

- ES Carcasa de protección, absorbedor de energía de 45 mm y conexión para arnés. Eslabón giratorio en la parte superior con testigo de caída y Resistencia > 15 kN. Cinta de 50 mm de ancho. Resistencia > 15kN.
- FR Carcasse de protection, absorbeur d'énergie 45 mm et connexion pour harnais. Lien giratoire sur la partie supérieure avec témoin de chute et Résistance > 15 kN. Lien de 50 mm de large. Résistance: > 15kN.
- EN Protective case, 45 mm shock absorber and connection for harness. Swivel with load indicator at the top. Resistance > 15 kN. 50 mm wide webbing. Resistance: > 15kN.
- IT Struttura di protezione, assorbitore di energia da 45 mm e collegamento imbracatura. Tornichetto girevole nella parte superiore con indicatore di caduta e Resistenza > 15kN. Nastro da 50mm di larghezza. Resistenza: >15kN.
- PT Carcaça protetora, amortecedor de energia de 45 mm e conexão para arnés. Argola giratória no topo com indicador de queda e resistência > 15 kN. Faixa de 50 mm de largura. Resistência: >15kN.

Ref	↔	max	📦	📦
1100 0375	2,5 m	140 kg	1	108,90

ANTICAÍDA RETRÁCTIL 2 M USO HORIZ. FACTOR 2 / ANTI CHUTE RÉTRACTILE 2 M UTILISATION HORIZ. FACTEUR 2  
RETRACTABLE FALL ARREST 2 M HORIZONTAL USE FACTOR 2 / ANTICADUTA REATRATTILE 2 M USO ORIZZ. FATTORE 2  
ANTI-QUEDA RETRÁTIL 2 M USO HORIZ. FATOR 2

**Kg**  
0.77

2 m

**FACTOR  
de caída 2**



**OK** Aristas vivas con absorbedor de energía integrado.  
Arêtes vives avec absorbeur d'énergie intégré.  
Sharp edges with shock absorber included.  
Spigoli vivi con assorbitore di energia integrato.  
Arestas vivas com absorvedor de energia integrado.

**EN360: 2002  
CAT III**

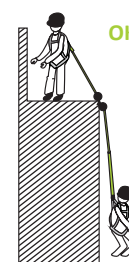

**FACTOR DE CAÍDA 2:** Se puede utilizar en una configuración en la que resulte necesario trabajar por encima del punto de anclaje.

**FACTEUR DE CHUTE 2:** Peut être utilisé dans une configuration lorsqu'il s'avère nécessaire de travailler au-dessus du point d'ancrage.

**FALL FACTOR 2:** It can be used when it is necessary to work above the anchor point.

**FATTORE DI CADUTA 2:** può essere utilizzato in una configurazione in cui risulta necessario lavorare sopra il punto di ancoraggio.

**FACTOR DE QUEDA 2:** pode ser usado em uma configuração na qual é necessário trabalhar acima do ponto de ancoragem.

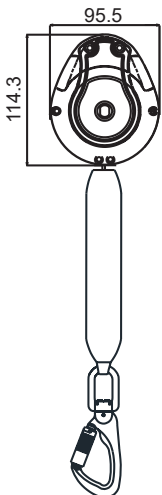

- ES Carcasa de polímero de alta resistencia, con cinta de 20 mm. Sistema de freno con fuerza de impacto inferior a 6 kN. Incluye absorbedor de energía protegido. Uso horizontal VG 11.060 (Rev. 08 - 10/2014). Eslabón giratorio y conector. Resistencia: > 15kN.
- FR Carcasse en polymère de haute résistance, avec liens de 20 mm. Système de frein avec force d'impact inférieur à 6 kN. Inclut absorbeur d'énergie protégé. Utilisation horizontale VG 11.060 (Rev. 08 - 10/2014). Lien rotatif et connecteur. Résistance: > 15kN.
- EN High resistant polymer case, with 20 mm webbing. Brake system with shock resistance lower than 6 kN. It includes protected shock absorber. Horizontal use VG 11.060 (Rev. 08 - 10/2014). Swivel and connector. Resistance: > 15kN.
- IT "Struttura in polimero ad alta resistenza, con cintura da 20 mm. Sistema di arresto con forza di impatto inferiore a 6kN. Include assorbitore di energia. Uso orizzontale VG 11.060 (Rev. 08 - 10/2014)". Tornichetto girevole e connettore. Resistenza: >15kN.
- PT "Carcaça de polímero de alta resistência, com cinturão de 20 mm. Sistema de freio com força de impacto inferior a 6 kN. Inclui absorvedor de energia protegido. Uso horizontal VG 11.060 (Rev. 08 - 10/2014)." Argola giratória e conector. Resistência: >15kN.

Ref	↔	max	📦	📦
1100 0371	2 m	140 kg	1	195,70





ANTICAÍDA DESLIZANTE CUERDA TRENZADA 10 M / ANTI CHUTE GLISSANTE CORDE TRESSÉE 10 M / NONSLIP FALL ARRESTER BRAIDED ROPE 10 M  
ANTICADUTA SCORREVOLE, CORDA INTRECCIATA 10M / ANTI QUEDA DESLIZANTE CONDA ENTRANÇADA



CE EN353-2: 2002  
CAT III

- ES Sistema de apertura/cierre simple y bloqueo automático doble, con dispositivo anti inversión Resistencia > 15 kN sistema de bloqueo manual. Suministrado con un conector y absorbedor de energía. Costura protegida con funda transparente que permite el control visual de las costuras.
- FR Système d'ouverture/fermeture simple et blocage automatique double, avec dispositif anti inversion Résistance > 15 kN système de blocage manuel. Fourni avec des connecteurs et absorbeur d'énergie. Couture protégée avec couverture transparente qui permet le contrôle visuel des coutures
- EN Simple opening/closing system and automatic double lock with non-inverting system, resistance > 15 kN, manual locking system. Supplied with connectors and shock absorber. Steams protected by a transparent sleeve, allowing visual control of the steams.
- IT Sistema con apertura/chiusura semplice e a doppio blocco automatico. Dotato di dispositivo anti-inversione, Resistenza > 15kN sistema di blocco manuale. Fornito con connettore e assorbitore di energia. Cuciture protette con rivestimento trasparente che ne consentono il controllo visivo.
- PT Sistema de abertura / fecho simples e duplo bloqueio automático, com dispositivo anti-inversão, Resistência > 15 kN sistema de bloqueio manual. Fornecido com um conector e absorvedor de energia. Costura protegida com cobertura transparente que permite o controle visual das costuras.

Ref	↔	📦	📊
1100 0383	10 m	1	95,40

ABSORBEDOR DE ENERGÍA CON CUERDA 1,5 M / AMORTISSEUR DE CHOC AVEC CORDE 1.5M / ROPE LANYARD 1.5M  
ASSORBITORE DI ENERGIA CON CORDA 1,5 M / ABSORVEDOR DE ENERGIA COM CORDA 1,5MT



Hebillas con guardacabo y empalmes con vaina.  
Boucles avec anneau et raccord.  
Thimble eyes and reinforced splices.  
Fibbie con guardacanapo e protette da guaine.  
Laço com dedal e emenda com bainha.

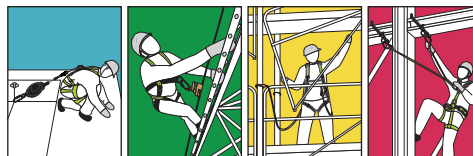

CE EN355: 2002  
EN354: 2010  
CAT III

- ES Absorbedor de 44 mm con 1.5 m de cuerda diámetro Ø12 mm, para impactos inferiores a 6kN.
- FR Absorbeur de 44 mm avec 1.5 m de corde de diamètre Ø12 mm, pour des impacts inférieurs à 6kN.
- EN 44 mm shock absorber with 1.5 m rope lanyard (Ø12 mm diameter) for impacts lower than 6kN.
- IT Assorbitore da 44 mm con 1,5 m di corda con diametro Ø12 mm, per impatti inferiori a 6kN.
- PT "Absorvedor de 44 mm com 1.5 m de corda e diâmetro Ø12 mm, para impactos inferiores a 6kN."

Ref	↔	📦	📊
1100 0129	1,5 m	1	30,20





**ARNESES ANTICAÍDAS / HARNAIS ANTI CHUTE / SAFETY HARNESS**  
**IMBRAGATURA ANTICADUTA / ARNÊS ANTI-QUEDA**



CUERDA DE SEGURIDAD P/ARNÉS 1,5 MTS. / CORDE DE SECURITE POUR HARNAIS 1,5M / SAFETY LINE FOR HARNESS 1,5M  
 CORDA DI SICUREZZA PER IMBRAGATURA / CORDA DE SEGURANÇA PARA ARNÊS 1,5M



12 mm

ES 1.5 m de cuerda diámetro Ø12 mm, con resistencia a la rotura 22kN.  
 FR 1.5 m de corde de diamètre Ø12 mm, avec résistance à la rupture 22kN.  
 EN 1.5 m safety line (Ø12 mm diameter) and breaking strength 22kN.  
 IT 1,5 m di corda con diametro Ø12 mm, con resistenza alla rottura d 22kN.  
 PT 1.5 m de corda e Ø12 mm de diâmetro, com a resistência à ruptura de 22 kN.



Hebillas con guardacabo y empalmes con vaina.  
 Boucles avec anneau et raccord.  
 Thimble eyes and reinforced splices.  
 Fibbie con guardacanapo e protette da guaine.  
 Laço com dedal e emenda com bainha.

Ref	↔	📦	📊
1100 0033	1,5 m	1	12,25

MOSQUETÓN CON ROSCA SEGURIDAD / MOUSQUETON AVEC FILETET SECURITE / HOOK WITH SAFETY STEEL THREAD  
 MOSCHETTONE CON FILETETTO SICUREZZA / MOSQUETAO DE SEGURANÇA COM ROSCA



25kN



18 mm

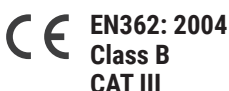

Ref	📦	📊
1100 0035	1	5,25

MOSQ. ACERO BLOQUEO AUTOMÁTICO DOBLE ACCIÓN / CROCHETS POUR CORDE DE SURVIE DOUBLE SECURITE / SNAP HOOK  
 GANCI PER LINEE VITA A DOPPIA SICUREZZA / GANCHO PARA LINHA DE VIDA DUPLO SEGUR O

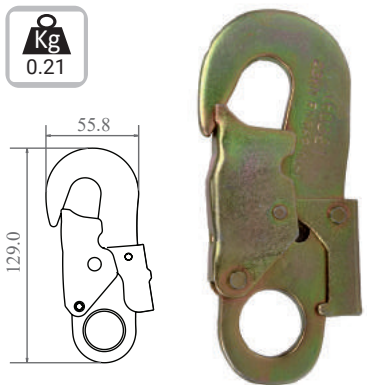

23kN



16 mm

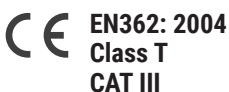

Ref	📦	📊
1100 0127	1	6,95

MOSQUETÓN DE ACERO PARA ANDAMIOS BLOQUEO AUTOMÁTICO DOBLE ACCIÓN / CROCHETS POUR CORDE DE SURVIE DOUBLE SECURITE  
 SCAFFOLD HOOK / IMBRAGATURA ANTICADUTA PER LAVORI IN SOSPENSIONE / ARNÊS ANTI-QUEDA PARA TRABALHO EM SUSPENSAO



23kN



50.8 mm



Agarre ergonómico  
 Poignée ergonomique  
 Ergonomic grip.  
 Impugnatura ergonomica.  
 Punho ergonómico.

Ref	📦	📊
1100 0128	1	10,40



LÍNEA DE VIDA TEMPORAL HORIZONTAL 20 M POR 2 PERSONAS / LIGNE DE VIE TEMP. HORIZONTALE 20 M POUR 2 PERSONNES  
TEMPORARY HORIZONTAL LIFELINE 20 M FOR 2 PEOPLE / LINEA VITA TEMP. ORIZZONTALE 20M PER 2 PERSONE  
LINHA DE VIDA TEMP. HORIZONTAL 20 M P/ 2 PESSOAS

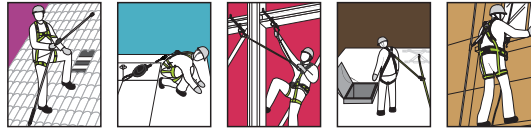

EN795: 2012  
CEN/TS 16415: 2013  
Type C

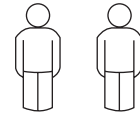

Probadura para que lo usen dos personas  
Testé pour être utilisé par 2 personnes  
Tested for the use of two people - 30 mm  
Testato per essere utilizzato da due persone - 30 mm  
Testado para ser usado por duas pessoas - 30 mm

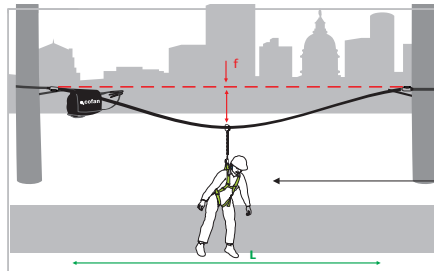
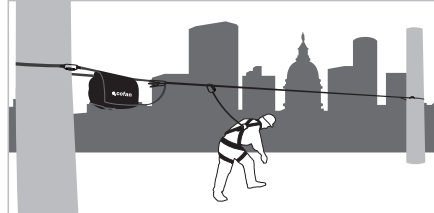

f = 3,30 m (para L = 20m)

CAT III

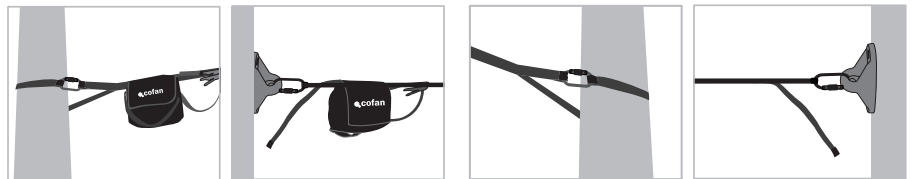

ES Línea de vida horizontal de correa de poliéster con extremos de tipo «horquilla» para engancharse a una estructura o a puntos de anclaje. Tensor de trinquete de acero para tensar el sistema una vez ajustada la longitud. Suministrado con una bolsa de almacenamiento no separable que permite guardar el excedente durante el uso, y guardar después del uso. Longitud ajustable de 2 a 20 m. Instalación rápida, temporal y sin perforar el punto de anclaje. No apto para trabajo en suspensión.

FR Ligne horizontale de ceinture en polyester avec extrémités type "fourche" pour se fixer à des structures ou à des points d'ancrage. Tenseur cliquet en acier pour tendre le système une fois la longueur ajustée. Fourni avec un sac de rangement non séparable qui permet de garder l'excédent pendant l'utilisation, et de le ranger après l'utilisation. Longueur réglable de 2 à 20 m. Installation rapide, temporaire et sans perforer le point d'ancrage. Non adapté au travail en suspension.

EN Polyester temporary horizontal lifeline with forked ends in order to anchor to a structure or to an adapted anchorage point. Steel ratchet to put the system into tension after adjusting the required length. Supplied with an indivisible storage bag allowing to keep the remaining lifeline during and after its use. Adjustable length from 2 to 20 m. Quick and temporary installation without perforating the anchor point. Not suitable for suspension works.

IT Cinghia in poliestere per linea di salvataggio orizzontale, con estremità di tipo "forcella" per aggancio su strutture o punti di ancoraggio. Tenditore a cricchetto in acciaio per bloccare il sistema una volta regolata la lunghezza desiderata. Attrezzatura fornita con sacca di stoccaggio, non separabile, che consente di conservare l'eccedente durante l'utilizzo salvaguardandolo dopo l'utilizzo stesso. Lunghezza regolabile da 2 a 20m. Semplice installazione, temporanea e senza necessità di forare il punto di ancoraggio. Non adatto per lavori in sospensione.

PT Linha de vida horizontal de correa de poliéster com extremidades do tipo "forquilha" para fixação a estruturas ou pontos de ancoragem. Tensor de catraca de aço para tensionar o sistema uma vez que o comprimento seja ajustado. Fornecido com um saco de armazenamento não separável que permite guardar o material excedente durante o uso e armazenar depois de utilizado. Comprimento ajustável de 2 a 20 m. Instalação rápida e temporária no ponto de ancoragem, não adequada para trabalhos em suspensão.

Ref	↔	📦	📦
1100 0382	20 m	1	117,40

ANILLA ANCLAJE POLIÉSTER 1,20 M RUPTURA +18KN / ANNEAU ANCRAGE POLYESTER 1.20 M RUPTURE + 18KN  
POLYESTER ANCHORAGE RING 1.20 M BREAKING STRENGTH +18KN / ANELLO ANCORAGGIO POLIESTERE 1,20M ROTTURA +18KN  
ANILHA ANCORAGEM POLIÉSTER 1,20 M RUTURA +18 KNN

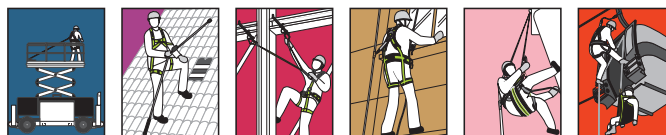

EN795: 2012  
Type B  
CAT III

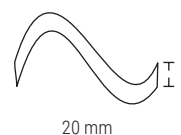

ES Cinta de poliéster de 20 mm cosida. Resistencia a la ruptura: 18 kN.

FR Ceinture en polyester de 20 mm cousue. Résistance à la rupture: 18 kN

EN Polyester sewed webbing (20 mm). Breaking strength: 18 kN

IT Nastro in poliestere da 20mm con cucitura. Resistenza alla rottura: 18kN

PT Fita de poliéster de 20 mm costurada. Resistência à ruptura: 18 kN

Ref	↔	📦	📦
1100 0384	1,20 m	1	9,90



PACK 2 RODILLERAS DE GEL BANDA ELÁSTICA CON VELCRO / PACK 2 GENOUIERES GEL BANDE ÉLASTIQUE AVEC VELCRO  
2-PC PACK OF GEL KEE PADS WITH AN ELASTIC STRAP AND HOOK & LOOP FASTENER / PACK 2 GINOCCHIERE IN GEL CON FASCIA ELASTICA E CHIUSURA A STRAPPO  
PACK 2 JOELHEIRAS DE GEL DUPLA BANDA ELÁSTICA COM VELCRO



**EN14404: 2004 + A1: 2010  
CAT II**

Ref	PACK		x pack	
<b>1100 0365</b>	2 uds	1 pack	<b>22,40</b>	✓

PACK 2 RODILLERAS DE GEL DOBLE BANDA ELÁSTICA / PACK 2 GENOUIERES GEL DOUBLE BANDE ÉLASTIQUE  
2-PC PACK OF GEL KEE PADS WITH A DOUBLE ELASTIC STRAP / PACK 2 GINOCCHIERE IN GEL CON DOPPIA FASCIA ELASTICA  
PACK 2 JOELHEIRAS DE GEL DUPLA BANDA ELÁSTICA



ES Ideales para aplicaciones sobre superficies irregulares, suelos laminados, trabajos en cemento, tejados y jardinería.

FR Parfaites pour des opérations sur des surfaces inégales, sols stratifiés, travaux de ciment, toitures et jardinage.

EN These knee pads are ideal for applications on uneven surfaces, laminated flooring, cement works, roofs, and gardening.

IT Le ginocchiere in gel sono ideate per applicazioni su superfici irregolari, pavimenti laminati, lavori con cemento, tetti e giardinaggio.

PT Ideais para aplicações sobre superfícies irregulares, chão laminados, trabalhos em cimentostelhados e jardinagem.

**EN14404: 2004 + A1: 2010  
CAT II**

**PVC - 35%      EVA - 20%  
POLYESTER - 35%      GEL - 10%**

Ref	PACK		x pack
<b>1100 0366</b>	2 uds	1 pack	<b>26,50</b>

SET 2 RODILLERAS EN POLIETILENO / SET 2 ROTULES EN POLYÉTHYLÈNE / 2-PC POLYETHYLENE KNEEPAD SET  
SET 2 CUSCINETTI IN POLIETILENE / JOGO 2 JOELHEIRAS EM POLIETILENO



Ref	PACK		x pack
<b>1100 2020</b>	2 uds	1 pack	<b>12,60</b>

RODILLERA DE PROTECCIÓN AJUSTABLE / GENOUIÈRE DE PROTECTION RÉGLABLE / ADJUSTABLE KNEE PADS  
GINOCCHIERE PROTETTIVE REGOLABILI / JOELHEIRAS DE PROTEÇÃO AJUSTÁVEIS



Ref	PACK		x pack
<b>1100 0139</b>	2 uds	1 pack	<b>16,40</b>

FAJA DE TRABAJO CON TIRANTES / CEINTURE DE TRAVAIL AVEC BRETelles / BACK SUPPORT BELT WITH STRAPS  
CINTURA LOMBARE / CINTURÃO DE TRABALHO COM ALÇAS

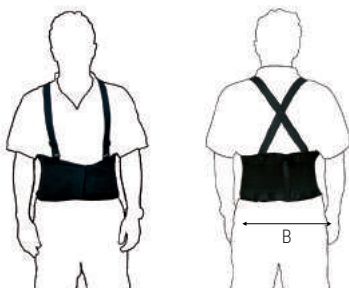

Ref	B		
<b>1100 0138 M</b>	78 - 92 cm	1	<b>15,81</b>
<b>1100 0138 L</b>	93 - 109 cm	1	<b>15,81</b>
<b>1100 0138 XL</b>	110 - 126 cm	1	<b>15,81</b>
<b>1100 0138 XXL</b>	127 - 140 cm	1	<b>15,81</b>

CLASIFICACIÓN DE TALLAS DE ROPA / CLASSIFICATION DES TAILLES DE VÊTEMENT / SIZES CLASSIFICATION  
CLASSIFICAZIONE DELLE TAGLIE DI ABBIGLIAMENTO / CLASSIFICAÇÃO DE MEDIDAS DE ROUPA

**PANTALONES Y BERMUDAS / TROUSERS, BERMUDAS**

**Hombre / Man**

SIZE	B (cm)	C (cm)
38	73-76	89-92
40	77-80	93-96
42	81-84	97-100
44	85-88	101-104
46	89-92	105-108
48	93-96	109-112
50	97-100	113-116
52	101-104	117-120
54	105-108	121-124
56	109-112	125-128
58	113-116	129-132
60	117-120	133-136
62	121-124	137-140
64	125-128	141-144

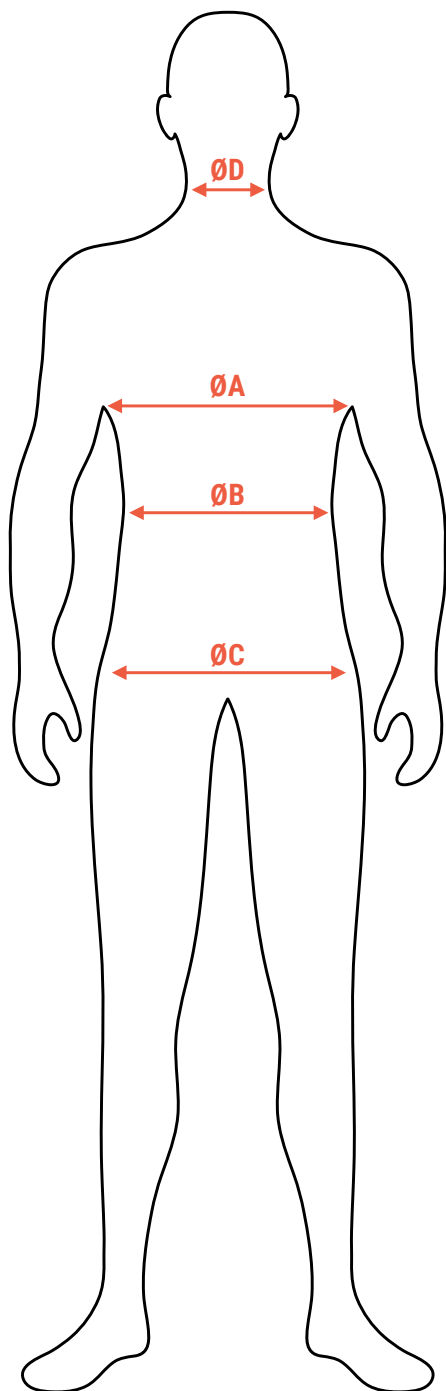

**CHAQUETAS, CHALECOS Y CAMISetas / JACKET, VESTS, SHIRTS**

**Hombre / Man**

SIZE	A (cm)	D (cm)
XS	73-80	35/36
S	81-88	37/38
M	89-96	39/40
L	97-104	41/42
XL	105-112	43/44
XXL	113-120	45/46
XXXL	121-128	47/48

**PETOS Y MONOS DE TRABAJO / COVERALLS**

**Hombre / Man**

SIZE	A (cm)	B (cm)
XS	77-84	65-72
S	85-92	73-80
M	93-100	81-88
L	101-108	89-96
XL	109-116	97-104
XXL	117-124	105-112
XXXL	125-132	113-120

**Mujer / Woman**

SIZE	A (cm)
XS	79-86
S	87-94
M	95-102
L	103-110
XL	111-118
XXL	119-126

**Niño / Children**

SIZE	A (cm)	B (cm)
2 Años / Years	65-70	57-60
4 Años / Years	71-75	61-64
6 Años / Years	76-80	65-68
8 Años / Years	81-85	69-72
10 Años / Years	86-90	73-76
12 Años / Years	91-95	77-80
14 Años / Years	96-100	81-84





**BUZO DE TRABAJO / BLEU DE TRAVAIL / WORK OVERALL**  
**TUTA DI PROTEZIONE DA LAVORO / FATO MACACO DE TRABALHO**



BUZOS BLANCO DE POLIPROPILENO 45 GR/M2 / COMBINAISON À CAPUCHE DE POLYPROPYLENE BLANC 45 GR/M2  
 WHITE POLYPROPYLENE HOODED OVERALL 45 GR/M2 / TUTA BIANCA IN POLIPROPILENE CON CAPPuccio 45 GR/M2  
 FATOS MACACO BRANCOS DE POLIPROPILENO 45 GR/M2



- ES Capucha cerrada con elástico. Cierre de cremallera. Elástico de ajuste en la cintura, en los tobillos y en los puños.
- FR Capuche à élastique. Fermeture par crémaillère. Taille, poignets et chevilles ajustés par bande élastique.
- EN Elastic closing hood. Zip fastener closing. Waist, ankles and fists with elastic fitting.
- IT Cappuccio elasticizzato. Chiusura a cerniera. Elastico di regolazione alla cintura, ai polsi e caviglie.
- PT Carapuço fechado com elástico. Fecho com zip. Elástico para ajustar na cintura, nos tornozelos e nos punhos.

Ref				
<b>1100 0205</b>	M	1	50	<b>6,80</b>
<b>1100 0206</b>	L	1	50	<b>6,80</b>
<b>1100 0207</b>	XL	1	50	<b>6,80</b>
<b>1100 0208</b>	XXL	1	50	<b>6,80</b>

BUZOS PROTECCIÓN QUÍMICA / COMBINAISON DE PROTECTION CHIMIQUE / CHEMICAL PROTECTION OVERALL  
 TUTA PROTEZIONE CHIMICA / MACACÃO PROTEÇÃO QUÍMICA



**EN ISO 13688:2013** **EN14605: 2005**  
**Type: 4, 5, 6**  
**CAT III**  
**+ A1: 2009**

**EN13034: 2005**  
**TIPO 6-B+A1 2009**

**EN1073-2**  
**CLASE 1: 2002**

**EN ISO 13982-1**  
**TIPO 5-B: 2004 + A1: 2010**

**EN1149-5: 2008**



- ES Nuevo no-tejido, suave, transpirable y resistente a las salpicaduras nocivas conforme a las normas europeas de tipo 4, 5 y 6. No suelta pelusa. Cierre con cremallera de doble cursor.
- FR Nouvelle texture, douce, respirante et résistante aux éclaboussures nocives. Conforme aux normes européennes type 4, 5 et 6 crémaillère à double curseur. Couverture de la chaussure polypropylène-blanc.
- EN Non-woven material, smooth, perspirant and resistant to harmful splashes in accordance with european standards type 4, 5 and 6. Not dusty. Double slide zip fastener.
- IT Nuovo tessuto non tessile, confortevole, traspirante e resistente. Conforme alle norme europee di tipo 4, 5 e 6. Non rilascia pelucchi. Chiusura a cerniera a doppio cursore.
- PT Material não-tecido, suave, transpirante e resistente a salpicos prejudiciais, de acordo com os padrões europeus tipo 4, 5 e 6. Não solta cotão. Fecho com dois zips duplo curso.

Ref				
<b>1100 0201</b>	M	1	25	<b>16,90</b>
<b>1100 0202</b>	L	1	25	<b>16,90</b>
<b>1100 0203</b>	XL	1	25	<b>16,90</b>
<b>1100 0204</b>	XXL	1	25	<b>16,90</b>
<b>1100 0201-A</b>	M	1	25	<b>16,90</b>
<b>1100 0202-A</b>	L	1	25	<b>16,90</b>
<b>1100 0203-A</b>	XL	1	25	<b>16,90</b>
<b>1100 0204-A</b>	XXL	1	25	<b>16,90</b>

CUBREZAPATO AZUL CPE / SUR-CHAUSSURES BLEUES CPE / BLUE CPE SHOE COVER  
 COPRISCARPE BLU IN CPE / COBRE SAPATOS AZUL CPE



- ES Fabricado en polietileno CPE. Galga 240. Suela especial, impermeable y transpirable. Elástico para un mejor ajuste.
- FR Fabriquées en polyéthylène CPE. Jauge 240. Semelle spéciale, imperméable et respirante. Élastiques pour un meilleur ajustement.
- EN This shoe cover is made of chlorinated polyethylene (CPE). 240 gauges. Special, waterproof and breathable sole fabric. It is composed of an elastic material for a better fit.
- IT Copriscarpe realizzate in film di materiale CPE. Calibro 240. Suola speciale, impermeabile e traspirante. Realizzate in un materiale elastico per offrire una migliore copertura.
- PT Fabricado em polietileno CPE. Galga 240. Sola especial, impermeável e transpirável. Elástico para melhor ajuste.

Ref		
<b>1100 0209</b>	100 pcs	<b>0,22</b>



CHALECOS ALTA VISIBILIDAD / GILET HAUTE VISIBILITE / LUMINESCENT WAISTCOAT / GIUBBINO ALTA VISIBILITÀ / COLETES ALTA VISIBILIDADE

EN ISO 20471: 2013 + A1: 2016  
CAT II



Ref				
1100 0025	XXL		1	4,45
1100 0025N	XXL		1	4,45
1100 0034*	Niños / Enfant / Children / Bambini / Crianças		1	4,15

\*EN 1150: 1999

CHALECO ALTA VISIBILIDAD AMARILLO CIERRE CON CREMALLERA, CLASE 2 / GILET HAUTE VISIBILITE FERMETURE ECLAIR  
YELLOW LUMINESCENT WAISTCOAT WITH ZIP, LEVEL 2 / GILET GIALLO AD ALTA VISIBILITA' CON CHIUSURA A ZIP, CLASSE 2  
COLETE ALTA VISIBILIDADE AMARELO FECHO COM ZIP, CLASSE 2



EN ISO 20471: 2013 + A1: 2016  
CAT II



Ref				
1100 0152M	M		1	5,41
1100 0152L	L		1	5,41
1100 0152XL	XL		1	5,41
1100 0152XXL	XXL		1	5,41

ROPA LABORAL / VÊTEMENT DE TRAVAIL / WORKWEAR  
ABITI DA LAVORO / ROUPA DE TRABALHO

BERMUDAS DE TRABAJO "POULSEN" / BERMUDAS DE TRAVAIL "POULSEN" / WORK SHORTS "POULSEN"  
BERMUDA DA LAVORO "POULSEN" / BERMUDAS DE TRABALHO "POULSEN"

Mod. POULSEN



ES Composición: 65% algodón/35% poliéster - 280 g/m².  
FR Composition: 65% coton/35% polyester - 280 g/m².  
EN Composition: 65% cotton/35% polyester - 280 g/m².  
IT Composizione: 65% cotone/35% poliestere - 280 g/m².  
PT Composição: 65% algodão/35% poliéster - 280 g/m².



Gris-Negro / Gris-Noir / Grey-Black  
Grigi-Nero / Cinza-Preto

Ref				
1100 2026-38	38	1		29,20
1100 2026-40	40	1		29,20
1100 2026-42	42	1		29,20
1100 2026-44	44	1		29,20
1100 2026-46	46	1		29,20
1100 2026-48	48	1		29,20
1100 2026-50	50	1		29,20
1100 2026-52	52	1		29,20
1100 2026-54	54	1		29,20
1100 2026-56	56	1		29,20
1100 2026-58	58	1		29,20
1100 2026-60	60	1		29,20
1100 2026-62	62	1		29,20
1100 2026-64	64	1		29,20

Beis-Negro / Beige-Noir / Beige-Black  
Beige-Nero / Bege-Preto

Ref				
1100 2027-38	38	1		29,20
1100 2027-40	40	1		29,20
1100 2027-42	42	1		29,20
1100 2027-44	44	1		29,20
1100 2027-46	46	1		29,20
1100 2027-48	48	1		29,20
1100 2027-50	50	1		29,20
1100 2027-52	52	1		29,20
1100 2027-54	54	1		29,20
1100 2027-56	56	1		29,20
1100 2027-58	58	1		29,20
1100 2027-60	60	1		29,20
1100 2027-62	62	1		29,20
1100 2027-64	64	1		29,20



PANTALÓN DE TRABAJO ELÁSTICO / PANTALON DE TRAVAIL ÉLASTIQUE / ELASTIC WORKING TROUSERS  
PANTALONE DA LAVORO ELÁSTICO / CALÇAS DE TRABALHO ELÁSTICO

**Mod. JANO**



**CON ELASTANO**

ES Composición: 97,76% algodón/2,24% elastano - 240 g/m<sup>2</sup>.  
FR Composition: 97,76% polyester/2,24% coton - 240 g/m<sup>2</sup>.  
EN Composition: 97,76% polyester/2,24% cotton - 240 g/m<sup>2</sup>.  
IT Composizione: 97,76% poliestere/2,24% cotone - 240 g/m<sup>2</sup>.  
PT Composição: 97,76% poliéster/2,24% algodão - 240 g/m<sup>2</sup>.

CE<sup>0161</sup>  
CAT1  
EN ISO 13688:2013



**SLIM FIT**

Ref		B (cm)	C (cm)		
1100 2064-38	38	73-76	89-92	1	36,90
1100 2064-40	40	77-80	93-96	1	36,90
1100 2064-42	42	81-84	97-100	1	36,90
1100 2064-44	44	85-88	101-104	1	36,90
1100 2064-46	46	89-92	105-108	1	36,90
1100 2064-48	48	93-96	109-112	1	36,90
1100 2064-50	50	97-100	113-116	1	36,90
1100 2064-52	52	101-104	117-120	1	36,90
1100 2064-54	54	105-108	121-124	1	36,90
1100 2064-56	56	109-112	125-128	1	36,90
1100 2064-58	58	113-116	129-132	1	36,90
1100 2064-60	60	117-120	133-136	1	36,90
1100 2064-62	62	121-124	137-140	1	36,90
1100 2064-64	64	125-128	141-144	1	36,90

**REGULAR FIT**

Ref		B (cm)	C (cm)		
1100 2065-38	38	73-76	89-92	1	36,90
1100 2065-40	40	77-80	93-96	1	36,90
1100 2065-42	42	81-84	97-100	1	36,90
1100 2065-44	44	85-88	101-104	1	36,90
1100 2065-46	46	89-92	105-108	1	36,90
1100 2065-48	48	93-96	109-112	1	36,90
1100 2065-50	50	97-100	113-116	1	36,90
1100 2065-52	52	101-104	117-120	1	36,90
1100 2065-54	54	105-108	121-124	1	36,90
1100 2065-56	56	109-112	125-128	1	36,90
1100 2065-58	58	113-116	129-132	1	36,90
1100 2065-60	60	117-120	133-136	1	36,90
1100 2065-62	62	121-124	137-140	1	36,90
1100 2065-64	64	125-128	141-144	1	36,90

DISPLAY PANTALÓN TRABAJO / DISPLAY PANTALON DE TRAVAIL / DISPLAY PADDED TROUSERS  
DISPLAY PANTALONI IMBOTTITI / DISPLAY CALÇAS DE TRABALHO



ES Capacidad para 12 cajas. Válido para modelo jano slim fit/regular fit.  
FR Capacité de 12 caisses. C'est valable pour le modèle jano slim fit/regular fit.  
EN It has a capacity of 12 boxes. It is valid for jano slim fit/regular fit model.  
IT Capacità di 12 scatole. Valido per il modello jano slim fit/regular fit.  
PT Capacidade de 12 caixas. Válido para modelo jano slim fit/regular fit.

El expositor se suministra sin pantalones de trabajo.  
Le présentoir est fourni sans pantalon de travail.  
The display stand is supplied without padded trousers.  
L'espositore viene fornito senza pantaloni imbottiti.  
O expositor é fornecido sem os calças de trabalho.

Ref		
EXPOSITOR30	1	28,50



CHAQUETA TRABAJO "WANKEE" / VESTE DE TRAVAIL / WORK JACKET / GIACCA DA LAVORO / CASACO DE TRABALHO

Mod. WANKEE



ES Composición: 65% poliéster/35% algodón - 245 g/m².

FR Composition: 65% polyester/35% coton - 245 g/m².

EN Composition: 65% polyester/35% cotton - 245 g/m².

IT Composizione: 65% poliestere/35% cotone - 245 g/m².

PT Composição: 65% poliéster/35% algodão - 245 g/m².

Azul marino / Navi blue

Blue marine / Blu scuro / Azul marinho

Ref	Icon 1	Icon 2	Icon 3	Price
1100 2011-XS	XS	1		39,40
1100 2011-S	S	1		39,40
1100 2011-M	M	1		39,40
1100 2011-L	L	1		39,40
1100 2011-XL	XL	1		39,40
1100 2011-XXL	XXL	1		39,40
1100 2011-XXXL	XXXL	1		39,40

Gris / Gris / Grey / Grigi / Cinza

Ref	Icon 1	Icon 2	Icon 3	Price
1100 2012-XS	XS	1		39,40
1100 2012-S	S	1		39,40
1100 2012-M	M	1		39,40
1100 2012-L	L	1		39,40
1100 2012-XL	XL	1		39,40
1100 2012-XXL	XXL	1		39,40
1100 2012-XXXL	XXXL	1		39,40

Verde / Verte / Green / Verde / Verde

Ref	Icon 1	Icon 2	Icon 3	Price
1100 2013-XS	XS	1		39,40
1100 2013-S	S	1		39,40
1100 2013-M	M	1		39,40
1100 2013-L	L	1		39,40
1100 2013-XL	XL	1		39,40
1100 2013-XXL	XXL	1		39,40
1100 2013-XXXL	XXXL	1		39,40

PANTALÓN TRABAJO "SERVET" / PANTALON DE TRAVAIL / WORK TROUSERS  
PANTALONI LAVORO / CALÇAS DE TRABALHO

Mod. SERVET



ES Composición: 65% poliéster/35% algodón - 245 g/m².

FR Composition: 65% polyester/35% coton - 245 g/m².

EN Composition: 65% polyester/35% cotton - 245 g/m².

IT Composizione: 65% poliestere/35% cotone - 245 g/m².

PT Composição: 65% poliéster/35% algodão - 245 g/m².

Azul marino / Navi blue

Blue marine / Blu scuro

Azul marinho

Ref	Icon 1	Icon 2	Icon 3	Price
1100 2001-38	38	1		24,40
1100 2001-40	40	1		24,40
1100 2001-42	42	1		24,40
1100 2001-44	44	1		24,40
1100 2001-46	46	1		24,40
1100 2001-48	48	1		24,40
1100 2001-50	50	1		24,40
1100 2001-52	52	1		24,40
1100 2001-54	54	1		24,40
1100 2001-56	56	1		24,40
1100 2001-58	58	1		24,40
1100 2001-60	60	1		24,40
1100 2001-62	62	1		24,40
1100 2001-64	64	1		24,40

Gris / Gris / Grey / Grigi / Cinza

Ref	Icon 1	Icon 2	Icon 3	Price
1100 2002-38	38	1		24,40
1100 2002-40	40	1		24,40
1100 2002-42	42	1		24,40
1100 2002-44	44	1		24,40
1100 2002-46	46	1		24,40
1100 2002-48	48	1		24,40
1100 2002-50	50	1		24,40
1100 2002-52	52	1		24,40
1100 2002-54	54	1		24,40
1100 2002-56	56	1		24,40
1100 2002-58	58	1		24,40
1100 2002-60	60	1		24,40
1100 2002-62	62	1		24,40
1100 2002-64	64	1		24,40

Verde / Verte / Green

Verde / Verde

Ref	Icon 1	Icon 2	Icon 3	Price
1100 2003-36	36	1		24,40
1100 2003-38	38	1		24,40
1100 2003-40	40	1		24,40
1100 2003-42	42	1		24,40
1100 2003-44	44	1		24,40
1100 2003-46	46	1		24,40
1100 2003-48	48	1		24,40
1100 2003-50	50	1		24,40
1100 2003-52	52	1		24,40
1100 2003-54	54	1		24,40
1100 2003-56	56	1		24,40
1100 2003-58	58	1		24,40
1100 2003-60	60	1		24,40
1100 2003-62	62	1		24,40
1100 2003-64	64	1		24,40



CHAQUETA TRABAJO "BENZ" / VESTE DE TRAVAIL / WORK JACKET / GIACCA DA LAVORO / CASACO DE TRABALHO

Mod. BENZ



ES Composición: 60% algodón/40% poliéster - 280 g/m<sup>2</sup>.

FR Composition: 60% coton/40% polyester - 280 g/m<sup>2</sup>.

EN Composition: 60% cotton/40% polyester - 280 g/m<sup>2</sup>.

IT Composizione: 60% cotone/40% poliestere - 280 g/m<sup>2</sup>.

PT Composição: 60% algodão/40% poliéster - 280 g/m<sup>2</sup>.

Gris-Negro / Gris-Noir  
Grey-Black / Grigi-Nero  
Cinza-Preto

Beis-Negro / Beige-Noir  
Beige-Black / Beige-Nero  
Bege-Preto

Blanco-Negro / Blanc-Noir  
White-Black / Bianco-Nero  
Branco-Preto

Ref				
1100 2015-XS	XS	1	43,05	
1100 2015-S	S	1	43,05	
1100 2015-M	M	1	43,05	
1100 2015-L	L	1	43,05	
1100 2015-XL	XL	1	43,05	
1100 2015-XXL	XXL	1	43,05	
1100 2015-XXXL	XXXL	1	43,05	

Ref				
1100 2016-XS	XS	1	43,05	
1100 2016-S	S	1	43,05	
1100 2016-M	M	1	43,05	
1100 2016-L	L	1	43,05	
1100 2016-XL	XL	1	43,05	
1100 2016-XXL	XXL	1	43,05	
1100 2016-XXXL	XXXL	1	43,05	

Ref				
1100 2017-XS	XS	1	43,05	
1100 2017-S	S	1	43,05	
1100 2017-M	M	1	43,05	
1100 2017-L	L	1	43,05	
1100 2017-XL	XL	1	43,05	
1100 2017-XXL	XXL	1	43,05	
1100 2017-XXXL	XXXL	1	43,05	

PANTALÓN TRABAJO "LENOIR" / PANTALON DE TRAVAIL "LENOIR" / WORK TROUSERS "LENOIR"  
PANTALONI LAVORO "LENOIR" / CALÇAS DE TRABALHO "LENOIR"

Mod. LENOIR



ES Composición: 60% algodón/40% poliéster - 280 g/m<sup>2</sup>.

FR Composition: 60% coton/40% polyester - 280 g/m<sup>2</sup>.

EN Composition: 60% cotton/40% polyester - 280 g/m<sup>2</sup>.

IT Composizione: 60% cotone/40% poliestere - 280 g/m<sup>2</sup>.

PT Composição: 60% algodão/40% poliéster - 280 g/m<sup>2</sup>.

Gris-Negro / Gris-Noir / Grey-Black  
Grigi-Nero / Cinza-Preto

Beis-Negro / Beige-Noir / Beige-Black  
Beige-Nero / Bege-Preto

Blanco-Negro / Blanc-Noir / White-Black  
Bianco-Nero / Branco-Preto

Ref				
1100 2005-38	38	1	34,85	
1100 2005-40	40	1	34,85	
1100 2005-42	42	1	34,85	
1100 2005-44	44	1	34,85	
1100 2005-46	46	1	34,85	
1100 2005-48	48	1	34,85	
1100 2005-50	50	1	34,85	
1100 2005-52	52	1	34,85	
1100 2005-54	54	1	34,85	
1100 2005-56	56	1	34,85	
1100 2005-58	58	1	34,85	
1100 2005-60	60	1	34,85	
1100 2005-62	62	1	34,85	
1100 2005-64	64	1	34,85	

Ref				
1100 2006-38	38	1	34,85	
1100 2006-40	40	1	34,85	
1100 2006-42	42	1	34,85	
1100 2006-44	44	1	34,85	
1100 2006-46	46	1	34,85	
1100 2006-48	48	1	34,85	
1100 2006-50	50	1	34,85	
1100 2006-52	52	1	34,85	
1100 2006-54	54	1	34,85	
1100 2006-56	56	1	34,85	
1100 2006-58	58	1	34,85	
1100 2006-60	60	1	34,85	
1100 2006-62	62	1	34,85	
1100 2006-64	64	1	34,85	

Ref				
1100 2007-38	38	1	34,85	
1100 2007-40	40	1	34,85	
1100 2007-42	42	1	34,85	
1100 2007-44	44	1	34,85	
1100 2007-46	46	1	34,85	
1100 2007-48	48	1	34,85	
1100 2007-50	50	1	34,85	
1100 2007-52	52	1	34,85	
1100 2007-54	54	1	34,85	
1100 2007-56	56	1	34,85	
1100 2007-58	58	1	34,85	
1100 2007-60	60	1	34,85	
1100 2007-62	62	1	34,85	
1100 2007-64	64	1	34,85	





CHAQUETA TRABAJO "GALILEO" / VESTE DE TRAVAIL / WORK TROUSERS / GIACCA DA LAVORO / CASACO DE TRABALHO

**Mod. GALILEO**



ES Composición: 60% algodón/40% poliéster - 300 g/m².  
FR Composition: 60% coton/40% polyester - 300 g/m².  
EN Composition: 60% cotton/40% polyester - 300 g/m².  
IT Composizione: 60% cotone/40% poliester - 300 g/m².  
PT Composição: 60% algodão/40% poliéster - 300 g/m².

Gris-Negro / Gris-Noir / Grey-Black / Grigi-Nero / Cinza-Preto

Ref			
1100 2043-S	S	1	63,55
1100 2043-M	M	1	63,55
1100 2043-L	L	1	63,55
1100 2043-XL	XL	1	63,55
1100 2043-XXL	XXL	1	63,55
1100 2043-XXXL	XXXL	1	63,55

PANTALÓN TRABAJO MULTIBOLSILLOS "CARLSON" / PANTALON DE TRAVAIL MULTIPOCHES "CARLSON" / MULTI-POCKET WORK TROUSERS "CARLSON"  
PANTALONI LAVORO MULTIB. "CARLSON" / CALÇAS DE TRABALHO MULTI BOLSOS "CARLSON"

**Mod. CARLSON**



ES Composición: 60% algodón/40% poliéster - 300 g/m².  
FR Composition: 60% coton/40% polyester - 300 g/m².  
EN Composition: 60% cotton/40% polyester - 300 g/m².  
IT Composizione: 60% cotone/40% poliester - 300 g/m².  
PT Composição: 60% algodão/40% poliéster - 300 g/m².

Gris-Negro / Gris-Noir / Grey-Black / Grigi-Nero / Cinza-Preto

Ref			
1100 2041-38	38	1	57,40
1100 2041-40	40	1	57,40
1100 2041-42	42	1	57,40
1100 2041-44	44	1	57,40
1100 2041-46	46	1	57,40
1100 2041-48	48	1	57,40
1100 2041-50	50	1	57,40
1100 2041-52	52	1	57,40
1100 2041-54	54	1	57,40
1100 2041-56	56	1	57,40
1100 2041-58	58	1	57,40
1100 2041-60	60	1	57,40
1100 2041-62	62	1	57,40
1100 2041-64	64	1	57,40





PANTALÓN TRABAJO "QUANT" / PANTALON DE TRAVAIL "QUANT" / WORK TROUSERS "QUANT"  
PANTALONI LAVORO "QUANT" / CALÇAS DE TRABALHO "QUANT"

**Mod. QUANT**



ES Composición: 60% algodón/40% poliéster - 300 g/m<sup>2</sup>.  
FR Composition: 60% coton/40% polyester - 300 g/m<sup>2</sup>.  
EN Composition: 60% cotton/40% polyester - 300 g/m<sup>2</sup>.  
IT Composizione: 60% cotone/40% poliestere - 300 g/m<sup>2</sup>.  
PT Composição: 60% algodão/40% poliéster - 300 g/m<sup>2</sup>.

Gris-Negro / Gris-Noir / Grey-Black / Grigi-Nero / Cinza-Preto

Ref				Ref			
1100 2042-38	38	1	47,30	1100 2042-52	52	1	47,30
1100 2042-40	40	1	47,30	1100 2042-54	54	1	47,30
1100 2042-42	42	1	47,30	1100 2042-56	56	1	47,30
1100 2042-44	44	1	47,30	1100 2042-58	58	1	47,30
1100 2042-46	46	1	47,30	1100 2042-60	60	1	47,30
1100 2042-48	48	1	47,30	1100 2042-62	62	1	47,30
1100 2042-50	50	1	47,30	1100 2042-64	64	1	47,30

PANTALÓN TRABAJO "PLUTÓN" / PANTALON DE TRAVAIL "PLUTÓN" / WORK TROUSERS "PLUTÓN"  
PANTALONI LAVORO "QUANT" / CALÇAS DE TRABALHO "PLUTÓN"

**Mod. PLUTÓN**



ES **Con un 2% de elastano**  
FR **Avec 2% d'élasthanne**  
EN **2% elastane**  
IT **2% in elastam**  
PT **Com um 2% de elastano**

EN 14404 EN 13688



ES Composición: 98% algodón/2% elastano - 180 g/m<sup>2</sup>.  
FR Composition: 98% coton/2% elasthanne - 180 g/m<sup>2</sup>.  
EN Composition: 98% cotton/2% elastane - 180 g/m<sup>2</sup>.  
IT Composizione: 98% cotone/2% elastan - 180 g/m<sup>2</sup>.  
PT Composição: 98% algodão/2% elastano - 180 g/m<sup>2</sup>.

Gris-Negro / Gris-Noir / Grey-Black / Grigi-Nero / Cinza-Preto

Ref				Ref			
1100 2062- 38	38	1	46,20	1100 2062-52	52	1	46,20
1100 2062-40	40	1	46,20	1100 2062-54	54	1	46,20
1100 2062-42	42	1	46,20	1100 2062-56	56	1	46,20
1100 2062-44	44	1	46,20	1100 2062-58	58	1	46,20
1100 2062-46	46	1	46,20	1100 2062-60	60	1	46,20
1100 2062-48	48	1	46,20	1100 2062-62	62	1	46,20
1100 2062-50	50	1	46,20	1100 2062-64	64	1	46,20



CHAQUETA TRABAJO MULTI-RIESGO "MICA" / VESTE DE TRAVAIL MULTI USAGE BLEU FONCÉ "MICA" / DARK BLUE MULTI-RISK WORK JACKET "MICA"  
GIACCA DA LAVORO PROT. MULTIRISCHIO BLU SCURO "MICA" / CASACO TRABALHO MULTI-RISCO AZUL ESCURO "MICA"

**Mod. MICA**



EN 13034  
2005+A1:2009  
TYPE 6  
(RIESGOS QUÍMICOS)



EN ISO  
11611 : 2015  
(PROTECCIÓN  
USO SOLDADURA)



IEC 61482-2:  
2009  
(RIESGOS TÉRMICOS)



EN ISO  
11612 : 2015  
A1 A2 B1 C1 E2 F1  
(PROTECCIÓN CONTRA  
CALOR/LLAMA)



EN1149-3 : 2004  
et EN1149-5 :2008  
(PROPIEDADES  
ELECTROSTÁTICAS)



EN 13688

ES Composición: 79% algodón - 20% poliéster - 1% carbono antiestático - 260 g/m<sup>2</sup>.

FR Composition: 79% coton - 20% polyester - 1% carbone antistatique - 260 g/m<sup>2</sup>.

EN Composition: 79% cotton - 20% polyester - 1% antistatic carbon - 260 g/m<sup>2</sup>.

IT Composizione: 79% cotone - 20% poliestere - 1% carbonio antistatico - 260 g/m<sup>2</sup>.

PT Composição: 79% algodão - 20% poliéster - 1% carbono antiestático - 260 g/m<sup>2</sup>.

**Azul oscuro / Bleu foncé / Dark Blue / Blu scuro / Azul escuro**

Ref			
1100 2058-XS	XS	1	117,60
1100 2058-S	S	1	117,60
1100 2058-M	M	1	117,60
1100 2058-L	L	1	117,60
1100 2058-XL	XL	1	117,60
1100 2058-XXL	XXL	1	117,60
1100 2058-XXXL	XXXL	1	117,60

PANTALÓN TRABAJO MULTI-RIESGO "SILICE" / PANTALON DE TRAVAIL MULTI USAGE BLEU FONCÉ "SILICE" / DARK BLUE MULTI-RISK WORK TROUSERS "SILICE"  
PANTALONE DA LAVORO PROT. MULTIRISCHIO BLU SCURO "SILICE" / CALÇAS TRABALHO MULTI-RISCO AZUL ESCURO "SILICE"

**Mod. SILICE**



EN 13034  
2005+A1:2009  
TYPE 6  
(RIESGOS QUÍMICOS)



EN ISO  
11611 : 2015  
(PROTECCIÓN  
USO SOLDADURA)



IEC 61482-2:  
2009  
(RIESGOS TÉRMICOS)



EN ISO  
11612 : 2015  
A1 A2 B1 C1 E2 F1  
(PROTECCIÓN CONTRA  
CALOR/LLAMA)



EN1149-3 : 2004  
et EN1149-5 :2008  
(PROPIEDADES  
ELECTROSTÁTICAS)



EN 13688

ES Composición: 79% algodón - 20% poliéster - 1% carbono antiestático - 260 g/m<sup>2</sup>.

FR Composition: 79% coton - 20% polyester - 1% carbone antistatique - 260 g/m<sup>2</sup>.

EN Composition: 79% cotton - 20% polyester - 1% antistatic carbon - 260 g/m<sup>2</sup>.

IT Composizione: 79% cotone - 20% poliestere - 1% carbonio antistatico - 260 g/m<sup>2</sup>.

PT Composição: 79% algodão - 20% poliéster - 1% carbono antiestático - 260 g/m<sup>2</sup>.

**Azul oscuro / Bleu foncé / Dark Blue / Blu scuro / Azul escuro**

Ref			
1100 2059-40	40	1	94,50
1100 2059-42	42	1	94,50
1100 2059-44	44	1	94,50
1100 2059-46	46	1	94,50
1100 2059-48	48	1	94,50
1100 2059-50	50	1	94,50
1100 2059-52	52	1	94,50
1100 2059-54	54	1	94,50



PETO TIRANTES DE TRABAJO "SINJOU" GRIS-NEGRO / SALOPETTES DE TRAVAIL GRIS-NOIR / WORK BIB AND BRACE "SINJOU" GREY-BLACK  
BRETELLE DA LAVORO GRIGIO-NERO / JARDINEIRAS DE TRABALHO CINZA-PRETO

**Mod. SINJOU**



ES Composición: 60% algodón/40% poliéster - 280 g/m².

FR Composition: 60% coton/40% polyester - 280 g/m².

EN Composition: 60% cotton/40% polyester - 280 g/m².

IT Composizione: 60% cotone/40% poliester - 280 g/m².

PT Composição: 60% algodão/40% poliéster - 280 g/m².

**Gris-Negro / Gris-Noir / Grey-Black / Grigi-Nero / Cinza-Preto**

Ref			
1100 2029-XS	XS	1	62,80
1100 2029-S	S	1	62,80
1100 2029-M	M	1	62,80
1100 2029-L	L	1	62,80
1100 2029-XL	XL	1	62,80
1100 2029-XXL	XXL	1	62,80
1100 2029-XXXL	XXXL	1	62,80

MONO DE TRABAJO "TESLA" / COMBINAISON DE TRAVAIL / OVERALLS / TUTA DA LAVORO / MACACÃO DE TRABALHO

**Mod. TESLA**



ES Composición: 65% algodón/35% poliéster - 245 g/m².

FR Composition: 65% coton/35% polyester - 245 g/m².

EN Composition: 65% cotton/35% polyester - 245 g/m².

IT Composizione: 65% cotone/35% poliester - 245 g/m².

PT Composição: 65% algodão/35% poliéster - 245 g/m².

**Azul marino / Navi blue / Blue marine / Blu scuro / Azul marinho**

Ref			
1100 2021-XS	XS	1	49,20
1100 2021-S	S	1	49,20
1100 2021-M	M	1	49,20
1100 2021-L	L	1	49,20
1100 2021-XL	XL	1	49,20
1100 2021-XXL	XXL	1	49,20
1100 2021-XXXL	XXXL	1	49,20



MONO DE TRABAJO "BIRO" GRIS-NEGRO / COMBINAISON DE TRAVAIL GRIS-NOIR / OVERALLS GREY-BLACK  
TUTA DA LAVORO GRIGIO-NERO / MACACÃO DE TRABALHO CINZA-PRETO

**Mod. BIRO**



ES Composición: 60% algodón/40% poliéster - 280 g/m².

FR Composition: 60% coton/40% polyester - 280 g/m².

EN Composition: 60% cotton/40% polyester - 280 g/m².

IT Composizione: 60% cotone/40% poliester - 280 g/m².

PT Composição: 60% algodão/40% poliéster - 280 g/m².

**Gris-Negro / Gris-Noir / Grey-Black / Grigi-Nero / Cinza-Preto**

Ref			
1100 2028-XS	XS	1	62,80
1100 2028-S	S	1	62,80
1100 2028-M	M	1	62,80
1100 2028-L	L	1	62,80
1100 2028-XL	XL	1	62,80
1100 2028-XXL	XXL	1	62,80
1100 2028-XXXL	XXXL	1	62,80

BUZO GRIS "ORGE" CON DOS CREMALLERAS PARA MUJER / COMBINAISON GRISE "ORGE" AVEC 2 CRÉMAILLÈRES POUR FEMME  
GREY COVERALL FOR WOMAN "ORGE" WITH DOUBLE ZIPPER / FELPA GRIGIA "ORGE" CON 2 ZIP PER DONA  
FATO MACACO CINZA "ORGE" COM 2 FECHOS PARA MULHER

**Mod. ORGE**



**MUJER  
FEMME  
WOMAN  
DONA  
MULHER**

ES Composición: 65% algodón/35% poliéster - 245 g/m².

FR Composition: 65% coton/35% polyester - 245 g/m².

EN Composition: 65% cotton/35% polyester - 245 g/m².

IT Composizione: 65% cotone/35% poliester - 245 g/m².

PT Composição: 65% algodão/35% poliéster - 245 g/m².

**Gris / Gris / Grey / Grigi / Cinza**

Ref			
1100 2060-XS	XS	1	58,59
1100 2060-S	S	1	58,59
1100 2060-M	M	1	58,59
1100 2060-L	L	1	58,59
1100 2060-XL	XL	1	58,59
1100 2060-XXL	XXL	1	58,59





BUZO KAKI/HAVANE "TOURNEVIS" CON 2 CREMALLERAS PARA NIÑOS / COMBINAISON KAKI/HAVANE "TOURNEVIS" AVEC 2 CRÉMAILLÈRES POUR ENFANTS  
KHAKI/HAVANE COVERALL FOR CHILDREN "TOURNEVIS" WITH DOUBLE ZIPPER / FELPA CACHI/HAVANA "TOURNEVIS" CON 2 ZIP PER BAMBINI  
FATO MACACO KAKI/HAVANE "TOURNEVIS" COM 2 FECHOS PARA CRIANÇAS

**Mod. TOURNEVIS**



**NIÑOS  
ENFANTS  
CHILDREN  
BAMBINI  
CRIANÇAS**

ES Composición: 65% algodón/35% poliéster - 245 g/m².

FR Composition: 65% coton/35% polyester - 245 g/m².

EN Composition: 65% cotton/35% polyester - 245 g/m².

IT Composizione: 65% cotone/35% poliester - 245 g/m².

PT Composição: 65% algodão/35% poliéster - 245 g/m².

Ref			
<b>1100 2061-2A</b>	2 Años / Years	1	<b>45,99</b>
<b>1100 2061-4A</b>	4 Años / Years	1	<b>45,99</b>
<b>1100 2061-6A</b>	6 Años / Years	1	<b>45,99</b>
<b>1100 2061-8A</b>	8 Años / Years	1	<b>45,99</b>
<b>1100 2061-10A</b>	10 Años / Years	1	<b>45,99</b>
<b>1100 2061-12A</b>	12 Años / Years	1	<b>45,99</b>
<b>1100 2061-14A</b>	14 Años / Years	1	<b>45,99</b>

SUDADERA CUELLO CREMALLERA "VOLTA" / SWEAT-SHIRT COL CREMALL. / SWEATSHIRT QUARTER ZIP  
FELPA A ZIP CON COLLETO / CAMISOLA POLAR GOLA ALTA

**Mod. VOLTA**

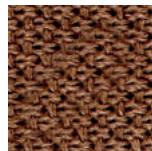

ES Composición: 100% poliéster - 280 g/m².

FR Composition: 100% polyester - 280 g/m².

EN Composition: 100% polyester - 280 g/m².

IT Composizione: 100% poliester - 280 g/m².

PT Composição: 100% poliéster - 280 g/m².

**Gris-Negro / Gris-Noir / Grey-Black  
Grigi-Nero / Cinza-Pretas**

Ref			
<b>1100 2051-S</b>	S	1	<b>36,70</b>
<b>1100 2051-M</b>	M	1	<b>36,70</b>
<b>1100 2051-L</b>	L	1	<b>36,70</b>
<b>1100 2051-XL</b>	XL	1	<b>36,70</b>
<b>1100 2051-XXL</b>	XXL	1	<b>36,70</b>
<b>1100 2051-XXXL</b>	XXXL	1	<b>36,70</b>

**Verde / Verte / Green / Verde / Verde**

Ref			
<b>1100 2052-S</b>	S	1	<b>36,70</b>
<b>1100 2052-M</b>	M	1	<b>36,70</b>
<b>1100 2052-L</b>	L	1	<b>36,70</b>
<b>1100 2052-XL</b>	XL	1	<b>36,70</b>
<b>1100 2052-XXL</b>	XXL	1	<b>36,70</b>
<b>1100 2052-XXXL</b>	XXXL	1	<b>36,70</b>





CHAQUETA POLAR "WALKER" GRIS-NEGRO / VESTE POLAIRE GRIS-NOIR / FLEECE JACKET GREY-BLACK  
GIACCA POLARE GRIGIO-NERO / CASACO POLAR CINZA-PRETO

**Mod. WALKER**



ES Composición: 100% poliéster - 370 g/m<sup>2</sup>.  
FR Composition: 100% polyester - 370 g/m<sup>2</sup>.  
EN Composition: 100% polyester - 370 g/m<sup>2</sup>.  
IT Composizione: 100% poliestere - 370 g/m<sup>2</sup>.  
PT Composição: 100% poliéster - 370 g/m<sup>2</sup>.

**Gris-Negro / Gris-Noir / Grey-Black**  
**Grigi-Nero / Cinza-Pretas**

Ref			
<b>1100 2055-S</b>	S	1	<b>61,50</b>
<b>1100 2055-M</b>	M	1	<b>61,50</b>
<b>1100 2055-L</b>	L	1	<b>61,50</b>
<b>1100 2055-XL</b>	XL	1	<b>61,50</b>
<b>1100 2055-XXL</b>	XXL	1	<b>61,50</b>
<b>1100 2055-XXXL</b>	XXXL	1	<b>61,50</b>

CHALECO MULTIBOLSILLOS ACOLCHADO "COLT" NEGRO / GILET MULTIPOCHE. REMBOURRE NOIR / MULTI-POCKET BODY WARMER BLACK  
GILET IMBOTTITO MULTITASCHE NERO / COLETE MULTI BOLSOS ACOLCHOADO PRETO

**Mod. COLT**



ES Composición: 65% poliéster/35% algodón - 245 g/m<sup>2</sup>.  
FR Composition: 65% polyester/35% coton - 245 g/m<sup>2</sup>.  
EN Composition: 65% polyester/35% cotton - 245 g/m<sup>2</sup>.  
IT Composizione: 65% poliestere/35% cotone - 245 g/m<sup>2</sup>.  
PT Composição: 65% poliéster/35% algodão - 245 g/m<sup>2</sup>.

**Negro / Noir / Black / Nero / Preto**

Ref			
<b>1100 2056-S</b>	S	1	<b>43,05</b>
<b>1100 2056-M</b>	M	1	<b>43,05</b>
<b>1100 2056-L</b>	L	1	<b>43,05</b>
<b>1100 2056-XL</b>	XL	1	<b>43,05</b>
<b>1100 2056-XXL</b>	XXL	1	<b>43,05</b>
<b>1100 2056-XXXL</b>	XXXL	1	<b>43,05</b>

CHAQUETA SOFT SHELL NEGRA "LISTER" / VESTE SOFT SHELL NOIRE / BLACK SOFTSHELL JACKET  
GIACCA SOFTSHELL NERA / CASACO SOFT SHELL PRETO

**Mod. LISTER**



ES **Transpirable / Impermeable**  
FR **Respirant / Imperméable**  
EN **Waterproof / Breathable**  
IT **Traspirante / Impermeabile**  
PT **Transpirável / Impermiável**

ES Composición: 94% poliéster/6% elastano - 340 g/m².  
FR Composition: 94% polyester/6% élasthane - 340 g/m².  
EN Composition: 94% polyester/6% elastane - 340 g/m².  
IT Composizione: 94% poliestere/6% elastan - 340 g/m².  
PT Composição: 94% poliéster/6% elastano - 340 g/m².

**3 Capas**  
**3 Layers**

Negro / Noir / Black / Nero / Preto

Ref			
<b>1100 2057-S</b>	S	1	<b>53,30</b>
<b>1100 2057-M</b>	M	1	<b>53,30</b>
<b>1100 2057-L</b>	L	1	<b>53,30</b>
<b>1100 2057-XL</b>	XL	1	<b>53,30</b>
<b>1100 2057-XXL</b>	XXL	1	<b>53,30</b>
<b>1100 2057-XXXL</b>	XXXL	1	<b>53,30</b>

POLO 2 TONOS "VERDON" / POLOS 2 TONS / POLO SHIRT 2 SHADES / POLO DOPPIA TONALITÀ / POLO 2 TONS

**Mod. VERDON**



ES Composición: 50% poliéster/50% elastano - 160 g/m².  
FR Composition: 50% polyester/50% élasthane - 160 g/m².  
EN Composition: 50% polyester/50% elastane - 160 g/m².  
IT Composizione: 50% poliestere/50% elastan - 160 g/m².  
PT Composição: 50% poliéster/50% elastano - 160 g/m².

Gris-Negro / Gris-Noir / Grey-Black  
Grigi-Nero / Cinza-Preto

Ref			
<b>1100 2030-XS</b>	XS	1	<b>22,60</b>
<b>1100 2030-S</b>	S	1	<b>22,60</b>
<b>1100 2030-M</b>	M	1	<b>22,60</b>
<b>1100 2030-L</b>	L	1	<b>22,60</b>
<b>1100 2030-XL</b>	XL	1	<b>22,60</b>
<b>1100 2030-XXL</b>	XXL	1	<b>22,60</b>
<b>1100 2030-XXXL</b>	XXXL	1	<b>22,60</b>

Beis-Negro / Beige-Noir / Beige-Black  
Beige-Nero / Bege-Preto

Ref			
<b>1100 2031-XS</b>	XS	1	<b>22,60</b>
<b>1100 2031-S</b>	S	1	<b>22,60</b>
<b>1100 2031-M</b>	M	1	<b>22,60</b>
<b>1100 2031-L</b>	L	1	<b>22,60</b>
<b>1100 2031-XL</b>	XL	1	<b>22,60</b>
<b>1100 2031-XXL</b>	XXL	1	<b>22,60</b>
<b>1100 2031-XXXL</b>	XXXL	1	<b>22,60</b>



CAMISETA TRANSPIRABLE "PILOTE" / TEE-SHIRT ANTI-TRANSPIRANT "PILOTE" / BREATHABLE T-SHIRT "PILOTE"  
T-SHIRT TRASPIRANTE "PILOTE" / CAMISA TRANSPIRÁVEL "PILOTE"

**Mod. PILOTE**



ES Composición: 100% poliéster - 160 g/m<sup>2</sup>.  
FR Composition: 100% polyester - 160 g/m<sup>2</sup>.  
EN Composition: 100% polyester - 160 g/m<sup>2</sup>.  
IT Composizione: 100% poliestere - 160 g/m<sup>2</sup>.  
PT Composição: 100% poliéster - 160 g/m<sup>2</sup>.

**Gris-Negro / Gris-Noir / Grey-Black  
Grigi-Nero / Cinza-Pretas**

Ref			
<b>1100 2063-S</b>	S	1	<b>20,95</b>
<b>1100 2063-M</b>	M	1	<b>20,95</b>
<b>1100 2063-L</b>	L	1	<b>20,95</b>
<b>1100 2063-XL</b>	XL	1	<b>20,95</b>
<b>1100 2063-XXL</b>	XXL	1	<b>20,95</b>
<b>1100 2063-XXXL</b>	XXXL	1	<b>20,95</b>

BATA BLANCA "PALETTE" / BLOUSE BLANCHE "PALETTE" / WHITE LABORATORY COAT "PALETTE"  
CAMICE BIANCO "PALETTE" / BATA BRANCA "PALETTE"

**Mod. PALETTE**



ES Composición: 100% algodón - 190 g/m<sup>2</sup>.  
FR Composition: 100% coton - 190 g/m<sup>2</sup>.  
EN Composition: 100% cotton - 190 g/m<sup>2</sup>.  
IT Composizione: 100% cotone - 190 g/m<sup>2</sup>.  
PT Composição: 100% algodão - 190 g/m<sup>2</sup>.

**Blanco / Blanc / White / Bianco / Branco**

Ref			
<b>1100 2018-XXS</b>	XXS	1	<b>24,99</b>
<b>1100 2018-XS</b>	XS	1	<b>24,99</b>
<b>1100 2018-S</b>	S	1	<b>24,99</b>
<b>1100 2018-M</b>	M	1	<b>24,99</b>
<b>1100 2018-L</b>	L	1	<b>24,99</b>
<b>1100 2018-XL</b>	XL	1	<b>24,99</b>
<b>1100 2018-XXL</b>	XXL	1	<b>24,99</b>
<b>1100 2018-XXXL</b>	XXXL	1	<b>24,99</b>

BATA AZUL OSCURA "LIMEUR" / BLOUSE BLEU FONCÉ "LIMEUR" / DARK BLUE LABORATORY COAT "LIMEUR"  
CAMICE BLU SCURO "LIMEUR" / BATA AZUL ESCURA "LIMEUR"

**Mod. LIMEUR**



ES Composición: 100% algodón - 240 g/m<sup>2</sup>.  
FR Composition: 100% coton - 240 g/m<sup>2</sup>.  
EN Composition: 100% cotton - 240 g/m<sup>2</sup>.  
IT Composizione: 100% cotone - 240 g/m<sup>2</sup>.  
PT Composição: 100% algodão - 240 g/m<sup>2</sup>.

**Azul oscuro / Bleu foncé / Dark Blue / Blu scuro / Azul escuro**











Ref			
<b>1100 2022-XXS</b>	XXS	1	<b>26,65</b>
<b>1100 2022-XS</b>	XS	1	<b>26,65</b>
<b>1100 2022-S</b>	S	1	<b>26,65</b>
<b>1100 2022-M</b>	M	1	<b>26,65</b>
<b>1100 2022-L</b>	L	1	<b>26,65</b>
<b>1100 2022-XL</b>	XL	1	<b>26,65</b>
<b>1100 2022-XXL</b>	XXL	1	<b>26,65</b>
<b>1100 2022-XXXL</b>	XXXL	1	<b>26,65</b>



TRAJE DE AGUA PU/PVC AMARILLO / COMBINAISON DE PLUIE PU/PVC JAUNE / PU/PVC YELLOW RAINWEAR  
 TUTA ANTIPIOGGIA PU/PVC GIALLO / FATO DE ÁGUA PU/PVC AMARELO













 **PU**  
**Poliuretano**

Ref					
1100 0291-S		S	1	10	<b>47,60</b>
1100 0291-M		M	1	10	<b>47,60</b>
1100 0291-L		L	1	10	<b>47,60</b>
1100 0291-XL		XL	1	10	<b>47,60</b>
1100 0291-XXL		XXL	1	10	<b>47,60</b>
1100 0291-XXXL		XXXL	1	10	<b>47,60</b>











TRAJE DE AGUA PU/PVC VERDE / COMBINAISON DE PLUIE PU/PVC VERTE / PU/PVC GREEN RAINWEAR  
 TUTA ANTIPIOGGIA PU/PVC VERDE / FATO DE ÁGUA PU/PVC VERDE



 **PU**  
**Poliuretano**

Ref					
1100 0292-S		S	1	10	<b>47,60</b>
1100 0292-M		M	1	10	<b>47,60</b>
1100 0292-L		L	1	10	<b>47,60</b>
1100 0292-XL		XL	1	10	<b>47,60</b>
1100 0292-XXL		XXL	1	10	<b>47,60</b>
1100 0292-XXXL		XXXL	1	10	<b>47,60</b>











**SÓLO PANTALÓN / ONLY TROUSERS**

Ref					
1100 0298-S		S	1	20	<b>18,90</b>
1100 0298-M		M	1	20	<b>18,90</b>
1100 0298-L		L	1	20	<b>18,90</b>
1100 0298-XL		XL	1	20	<b>18,90</b>
1100 0298-XXL		XXL	1	20	<b>18,90</b>
1100 0298-XXXL		XXXL	1	20	<b>18,90</b>

TRAJE DE AGUA PU/PVC AZUL / COMBINAISON DE PLUIE PU/PVC BLEUE / PU/PVC BLUE RAINWEAR  
 TUTA ANTIPIOGGIA PU/PVC BLU / FATO DE ÁGUA PU/PVC AZUL













 **PU**  
**Poliuretano**

Ref					
1100 0293-S		S	1	10	<b>47,60</b>
1100 0293-M		M	1	10	<b>47,60</b>
1100 0293-L		L	1	10	<b>47,60</b>
1100 0293-XL		XL	1	10	<b>47,60</b>
1100 0293-XXL		XXL	1	10	<b>47,60</b>
1100 0293-XXXL		XXXL	1	10	<b>47,60</b>

ABRIGO DE LLUVIA VERDE POLIÉSTER/PVC / BLOUSON DE PLUIE VERTE POLYESTER/PVC / POLYESTER/PVC GREEN RAINCOAT  
 GIACCA ANTIPIOGGIA VERDE POLIESTERE/PVC / CASACO DE CHUVA VERDE POLIÉSTER/PVC



Ref					
1100 0299-S		S	1	20	<b>15,50</b>
1100 0299-M		M	1	20	<b>15,50</b>
1100 0299-L		L	1	20	<b>15,50</b>
1100 0299-XL		XL	1	20	<b>15,50</b>
1100 0299-XXL		XXL	1	20	<b>15,50</b>
1100 0299-XXXL		XXXL	1	20	<b>15,50</b>

PONCHO DE AGUA VERDE PVC/POLIÉSTER TALLA ÚNICA / PONCHO DE PLUIE VERT PVC/POLYESTER TAILLE UNIQUE  
PVC/POLYESTER GREEN RAIN PONCHO ONE SIZE / PONCHO ANTIPIOGGIA VERDE PVC/POLIESTERE - TAGLIA UNICA  
CAPA DE ÁGUA VERDE PVC/POLIÉSTER TAMANHO ÚNICO



Ref					
1100 0295		1	20	12,06	

ABRIGO LARGO DE LLUVIA VERDE PU/POLIÉSTER / BLOUSON DE PLUIE VERTE POLYESTER/PU / PU/POLYESTER GREEN RAINCOAT  
GIACCA ANTIPIOGGIA VERDE POLIESTERE/PU / CASACO DE CHUVA VERDE POLIÉSTER/PU



**EXTRALARGO / EXTRA-LONG**

ES Fabricado 170 g/m<sup>2</sup> PU/Poliéster. Incluye capucha, cordones y tapones. Cierres de plástico y velcro. 2 bolsillos con tapa frontal.  
FR Fabriqué avec 170 g/m<sup>2</sup> de PU / polyester. Comprend: capuche, lacets et fermetures en plastique et velcro. 2 poches avec rabat avant.  
EN Made of 170g/m<sup>2</sup> of PU/polyester. Includes: hood, drawstring hood and plastic, and hook and loop fastenings. It has 2 front pockets.  
IT Prodotte con 170g/m<sup>2</sup> di PU/poliestere. Provista di: cappuccio, cordini e tasche esterne chiuse con patelle. Con 2 tasche frontali.  
PT Fabricado em PU / poliéster de 170 g / m<sup>2</sup>. Inclui capuz, cordões e fechos de plástico e velcro. 2 bolsos frontais com tampa.



Ref					
1100 0297-S		S	1	10	34,20
1100 0297-M		M	1	10	34,20
1100 0297-L		L	1	10	34,20
1100 0297-XL		XL	1	10	34,20
1100 0297-XXL		XXL	1	10	34,20
1100 0297-XXXL		XXXL	1	10	34,20

TRAJES DE AGUA CON TRIPLE CAPA PVC - POLIÉSTER / VÊTEMENT DE PLUIE TRIPLE ÉPAISSEUR, PVC - POLYESTER / TRIPLE-LAYER RAINSUIT, PVC - POLYESTER  
ANTIPIOGGIA CON TRIPLE GIUNTURE, PVC - POLIESTERE / FATOS DE ÁGUA COM TRIPLA CAMADA, PVC - POLÉSTER



Ref					
1100 0112-M		M	1	20	18,25
1100 0112-L		L	1	20	18,25
1100 0112-XL		XL	1	20	18,25
1100 0112-XXL		XXL	1	20	18,25
1100 0112-XXXL		XXXL	1	20	18,25
1100 0121-M		M	1	20	18,25
1100 0121-L		L	1	20	18,25
1100 0121-XL		XL	1	20	18,25
1100 0121-XXL		XXL	1	20	18,25
1100 0121-XXXL		XXXL	1	20	18,25
1100 0122-M		M	1	20	18,25
1100 0122-L		L	1	20	18,25
1100 0122-XL		XL	1	20	18,25
1100 0122-XXL		XXL	1	20	18,25
1100 0122-XXXL		XXXL	1	20	18,25

ES Traje de agua con triple capa, hecho en PVC bañado en poliéster. Sus costuras selladas por calor ofrecen un 100% de impermeabilidad. Excelente calidad para cualquier temperatura, ideal para minería, construcción, industria, etc.  
FR Vêtement triple épaisseur en PVC avec traitement polyester. Couture soudées offrent 100% d'imperméabilité. Excellente tenue face au mauvais climat, parfait pour le bâtiment, industrie, les mines.  
EN Rainwear, triple-layer rainsuit, made of heavy duty PVC coated on polyester, heat-sealed seams offer 100% waterproof, excellent quality for any temperature, ideal for mining, construction, industrial, etc.  
IT Antipioggia in PVC con giunture saldate a caldo per uso prolungato. Leggero, flessibile e confortevole. Protezione sicura contro pioggia e vento. Antipioggia blu in triplo strato, in PVC a bagno di poliestere. Le giunture saldate a caldo offrono il 100% di impermeabilità. Eccellente qualità per qualunque temperatura. Ideale per miniere, cantieri, industria, etc.  
PT Impermeáveis, de camada tripla, feito de PVC revestido em poliéster, costuras termo seladas oferecem 100% à prova d'água, de excelente qualidade para qualquer temperatura, ideal para mineração, construção, indústria, etc.







ES Este calzado de seguridad cumple las normas establecidas por el Reglamento (UE) 2016/425 así como los requisitos exigidos por el estándar Europeo EN ISO 20345:2011.

FR Ces chaussures de sécurité répondent aux normes établies par la Directive (UE) 2016/425 ainsi qu'aux conditions exigées par la norme Européenne EN ISO 20345:2011.

EN This safety footwear complies with the Regulation (EU) 2016/425 and meets the requirements of the European standard EN ISO 20345:2011.

IT Queste calzature di sicurezza soddisfano le normative stabilite dal Regolamento (UE) 2016/425 così come i requisiti richiesti dallo standard Europeo EN ISO 20345:2011.

PT Este calçado de segurança cumpre o Regulamento (UE) 2016/425 e cumpre os requisitos exigidos da norma europeia EN ISO 20345: 2011.

**MARKING CODE**

Resistencia a la penetración (1.100 Newtons) / Résistance pénétration / Penetration resistance / Resistenza alla penetrazione / Resistência à penetração	P
Propiedades Eléctricas / Propriétés électriques / Electrical properties / Proprietà Elettriche / Propriedades Elétricas	
- Conductivo (resistencia máxima de 100 kΩ) / Conductive / Conducibilità / Condutivo	C
- Antiestático (rango de resistencia desde 100 kΩ hasta 1000 MΩ) / Antistatique / Antistatico / Antiestática	A
- Aislante / Isolante / Insulating / Isolante / Isolante	I
Resistencia a entornos perjudiciales / Résistance dans les environnements hostiles / Resistance to inimical environments / Resistenza a ambienti pericolosi / Resistência a ambientes nocivos	
- Aislamiento del frío / Isolation contre le froid / Insulation against cold / Isolamento dal freddo / Isolamento do frio	CI
- Aislamiento del calor / Isolation contre la chaleur / Insulation against heat / Isolamento dal calore / Isolamento do calor	HI
Absorción de Energía (20 Julios) / Résistance de la partie arrière / Energy absorption of seat region / Assorbimento di Energia / Absorção de Energia	E
Resistencia al agua / Haute résistance à l'eau / Water resistance / Resistenza all'acqua / Impermeável	WR
Protección metatarsiano / Protection métatarsien / Metatarsal protection / Protezione del metatarso / Proteção do metatarso	M
Protección del tobillo / Protection de la cheville / Ankle protection / Protezione della caviglia / Proteção do tornozelo	AN
Resistencia al agua / Haute résistance à l'eau / Water resistant upper / Resistenza all'acqua / Impermeável	WRU
Resistencia a los cortes / Haute résistance à la coupure / Cut resistant upper / Resistenza ai tagli / Resistência aos cortes	CR
Resistencia al calor suela externa (300°C) / Haute résistance à la chaleur / Heat resistant outsole / Resistenza al calore suola esterna / Resistente ao calor, sola externa	HRO
Resistencia a los hidrocarburos / Résistance à l'hydrocarbure / Hydrocarbon resistant / Resistenza agli idrocarburi / Resistência aos hidrocarbonetos	FO

**CADUCIDAD DEL CALZADO DE SEGURIDAD / EXPIRATION / USURA SCARPE**

ES - 10 años después de la fecha de fabricación si el calzado tiene la superficie de piel y de goma la suela.

- 3 años después de la fecha de fabricación si el calzado incluye PU.

FR - 10 ans après la date de fabrication pour les chaussures avec cuir supérieur et caoutchouc.

- 3 ans après la date de fabrication pour les chaussures avec PU.

EN - 10 years after the date of manufacturing for shoes with upper leather and rubber sole.

- 3 years after the date of manufacturing for shoes including PU.

IT - 10 anni dalla data di fabbricazione, se la calzatura ha la tomaia in pelle e la suola in gomma.

- 3 anni dalla data di fabbricazione se la calzatura è realizzata in PU.

PT - 10 anos após a data de fabrico se o calçado tem a superfície de pele e a sola de borracha.

- 3 anos após a data de fabricação se o calçado inclui PU.

Ejemplos de marcas Exemples de marquages Examples of markings Esempi di marcatura Exemplos de marcas	Explicación / Explications / Description Descrizione / Explicação
COFAN	Marca identificativa / Code Identification Identification Mark / Marchio identificativo Marca de identificação
CE	CE
EN ISO 20345:2011	Número del estándar Europeo Nom de la norme Européenne European Standard number / Codice dello standard Europeo Número do standard Europeu
9 (43)	Talla / Taille / Size / Taglia / Tamanho
II 05	Fecha de Fabricación / Date of fabrication Manufacture date / Data di Fabbricazione Data de Fabricação
SB	Categoría de Protección / Catégorie de protection Protection category / Categoria di Protezione Categoria de Proteção
A	Código propiedad adicional / Code additionnel de propriété Additional property code / Codice proprietà addizionali Código propriedade adicional

**CATEGORÍA / CATEGORIE  
CATEGORY / CATEGORIA  
CATEGORIA**

**ISO 20345:2011 - REQUISITOS / RÉPONSE / REQUIREMENTS / REQUISITI / REQUISITOS**

SB	<b>Requisitos básicos / Réponse minima / Basic requirements / Requisiti minimi / Requisitos básicos</b> Para calzado de seguridad con puntera resistente a impactos de 200 Julios / Pointe résistant à 200 J / Toecap resistant to 200J / Puntale in acciaio 200J / Biqueira resistente a impactos de 200J Req. básicos adicionales / Conditions basiques additionnelles / Basic added req. / Requisiti min. addizionali / Requisitos básicos adicionales
S1	<b>Req. básicos adicionales / Conditions basiques additionnelles / Basic added req. / Requisiti min. addizionali / Requisitos básicos adicionales</b> Zona talón cerrada / Zone chèque fermée / Back part closed / Zona chiusa del tallone / Zona do calcanhar fechada Propiedades antiestáticas / Propriété antistatique / Antistatic properties / Proprietà antistatiche / Propriedades antiestáticas Absorción de energía en el tacón / Absorption d'énergie du talon / Energy absorption of seat region / Assorbimento di energia nel tacco / Absorção de energia no salto Resistencia a hidrocarburos / Résistance à l'hydrocarbure / Hydrocarbon resistant / Resistenza agli idrocarburi / Resistência aos hidrocarbonetos
S2	S1+ Resistencia al agua / Tige résistant à la pénétration et à l'absorption d'eau / Water penetration and water absorption / Resistenza all'entrata d'acqua / Resistência à água
S3	S2+ Plantilla de acero / Semelle anti-perforation / Steel sole / Plantare in acciaio / Palmilha em aço Suela con relieve / Semelle à crampons / Cleated outsole / Suola con rilievi / Sola com relevo
S4	Absorción de energía en el tacón / Absorption d'énergie du talon / Energy absorption of seat region / Assorbimento di energia nel tacco / Absorção de energia no salto Propiedades antiestáticas / Propriété antistatique / Antistatic properties / Proprietà antistatiche / Propriedades antiestáticas
S5	S4+ Suela con resaltes / Semelle à crampons / Cleated outsole / Suola con risalti / Sola com saliências



Calzado antiestático  
Chaussure anti-statique  
Antistatic footwear  
Calzatura antistatica  
Calçado antiestático



Suela resistente a hidrocarburos y aceites  
Semelle résistante aux huiles et hydrocarbures  
Sole unit resistant to oils and fuels  
Suola resistente a oli e idrocarburi  
Sola resistente a hidrocarbonetos e óleos



Material hidrófugo  
Materiaux impermeable  
Waterproof upper  
Materiale impermeabile  
Material impermeável



Puntera resistente a 200 J  
Pointe acier résistante a 200 degres  
Steel toecap resistant to 200 J  
Puntale in acciaio resistente a 200 J  
Biqueira resistente a 200J



Suela antideslizante  
Semelle anti-dérapante  
Antislip sole unit  
Suola antiscivolo  
Sola antiderrapante



Plantilla antiperforación  
Semelle acier  
Steel midsole  
Suola in acciaio  
Sola intermédia em aço



Suela resistente a altas temperaturas  
Semelle résistante aux hautes températures  
Heat resistance sole  
Suola resistente alle alte temperature  
Sola resistente a altas temperaturas



Absorción de energía en el tacón  
Systeme amortisseur de choc au talon  
Energy absorption of seat region  
Tacco ad assorbimento d'energia  
Absorção de energia no salto



Fabricado en material transpirable  
Fabriqué en matériaux étanche  
Breathable upper material  
Fabricatto in materiale traspirante  
Fabricado em material transpirável

SET 4 PARES CALCETINES REFORZADOS C/POLIAMIDA / SET DE 4 PAIRES DES CHAUSSETTES RENFORCÉES C/POLYAMIDE  
SET OF 4 PAIR OF REINFORCED SOCKS C/POLYAMIDE / SET DI 4 PAIA DI CALZE RINFORZATE C/POLIAMMIDICA  
SET DE 4 PARES DE MEIAS REFORÇADAS C/ POLIAMIDA

- ① ES Talón, tobillo y puntera reforzados de poliamida para una mayor resistencia al desgaste.  
FR Pré-talon, talon et pointe renforcés en Polyamide pour une meilleure résistance à l'usure.  
EN Reinforced pre-heel, heel with Polyamid for a better wear resistance.  
IT Tallone, sopra tallone e punta rinforzati in poliammide per una migliore resistenza all'usura.  
PT Calcanhar, tornozelo e punteira reforçada para maior resistência ao desgaste.



- ② ES Caña de doble punto elástico para un mayor confort.  
FR Double bord côte élastique pour plus de confort.  
EN Double elastic-rib stitch for more comfort.  
IT Doppio bordo a costine elastico per il massimo confort.  
PT Zona do elástico com ponto duplo para maior conforto.



Precio pack 4 pares  
Price pack 4 pairs

65% Algodón / Coton / Cotton / Cotone / Algodão  
25% Poliéster / Polyester / Polyester / Poliestere / Poliéster  
7% Poliamida / Polyamide / Polyamid / Poliammide / Poliamida  
3% Elastano / Élasthanne / Elastane / Elastine / Elastano

Ref					
1100 2066-M	39 - 42	1	30	15,99	✓
1100 2066-L	43 - 45	1	30	15,99	✓
1100 2066-XL	46 - 48	1	30	15,99	✓

CALZADO COMFORT PLUS / CHAUSSURES COMFORT PLUS / COMFORT PLUS FOOTWEAR / CALZATURE COMFORT PLUS / CALÇADO COMFORT PLUS



- ES Máximo confort y transpiración. Forma extra-ancha. Mayor ventilación de los pies.  
FR Confort maximal et transpiration. Forme extra-large. Aération des pieds.  
EN More comfortable and very good respiration. Extra width.  
IT Soletta anatomica. Antisudore e antistatica. Pianta e punta extra-larga, per un maggiore confort e una migliore ventilazione del piede.  
PT Máximo conforto e respirável. Forma extralarga. Maior ventilação dos pés.

PUNTERA CARBÓN LIGHT / POINTE CARBON LIGHT / CARBON LIGHT TOE / PUNTALE IN CARBON LIGHT / BIQUEIRA CARBON LIGHT.



- ES Máxima ligereza: un 51% menos pesada que una puntera de acero. Amagnética: ideal para todos los ambientes donde la presencia de acero no es válida (detectores de metales en los aeropuertos o lugares de elevado control eléctrico). Anticorrosiva y atérmica.  
FR Légèreté maximale: 51% moins lourde qu'une pointe en 'acier. Amagnétique: idéal pour toutes les situations où la présence d'acier n'est pas autorisée (détecteurs de métaux dans les aéroports ou les lieux de contrôle électrique important). Anticorrosif et athermique.  
EN Lighter than steel toecap. Non-magnetic: ideal solution for places where steel is not allowed (airport detectors of metal or places with high electricity control). Anticorrosive and non thermic.  
IT Massima leggerezza: 51% più leggero di un puntale in acciaio. Amagnetica: ideale per tutti gli ambienti in cui l'acciaio non è permesso (rilevatori di metalli degli aeroporti o ambienti ad elevato controllo elettrico). Non soggetto a corrosione e atermico.  
PT Leveza máxima: 51% menos pesada que uma biqueira de aço. Não-magnética: solução ideal para locais onde o aço não é permitido (detectores de metal em aeroportos ou locais de alto controle elétrico). Anticorrosivo. Não térmica.

PLANTILLA ANTIPERFORACIÓN FLEX / SEMELLE ANTI-PERFORATION FLEX / ANTI-PERFORATION INSOLE FLEX  
PLANTARE ANTIPERFORAZIONE FLEX / PALMILHA ANTI-PERFURAÇÃO FLEX



- ES Más ligera y flexible respecto al acero. Aumenta la seguridad, el espacio cubierto es del 100% de la superficie del pie. Tejido de alta tecnología, resiste hasta 1200 N. Amagnética y antialérgica.  
FR Plus légère et plus flexible par rapport à l'acier. Augmente la sécurité, Protège 100% de la surface du pied. Le tissu provient de la haute technologie, résiste jusqu'à 1200N. Amagnétique et antiallergique.  
EN Lighter and more flexible than steel insoles. Safer than steel insoles, as this covers 100% of the surface. High technology ceramic weave, resistant to 1200N. Non-magnetic and antiallergic.  
IT Più leggero e flessibile rispetto all'acciaio. Aumenta il livello di sicurezza, con una copertura del 100% della superficie del piede. Tessuto ad elevata tecnologia, resistente fino a 1200N. Amagnetica ed antiallergica.  
PT Mais leve e mais flexível do que de aço. Mais seguro, já que esta cobre 100% da superfície do pé. Tecido de alta tecnologia, resistente até 1200 N. Não-magnética e antialérgica.



ZAPATO PIEL NEGRA / CHAUSSURE PEAU NOIRE / BLACK LEATHER SHOE / SCARPA PELLE NERA / SAPATO PELE PRETA

**Mod. MIRTO**

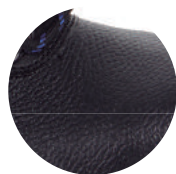

**S3 + SRC  
EN ISO 20345: 2011**

Puntera carbón light.  
Pointe carbone light.  
Carbon light toe.  
Puntale in carbonio leggero.  
Biqueira carbono light.

Reflectante.  
Réfléchissante.  
Reflective.  
Catarifrangente.  
Reflexivo.

ES Plantilla anatómica, antisudor y antiestática.  
FR Semelle anatomique antisueur et antistatique.  
EN Antistatic, anti-sweating, anatomical insole.  
IT Soletta anatomica, antisudore e antiestatica.  
PT Palmilha anatómica, anti-suor e antiestática.

Ref				
1200 4336	36	1	10	51,85
1200 4337	37	1	10	51,85
1200 4338	38	1	10	51,85
1200 4339	39	1	10	51,85
1200 4340	40	1	10	51,85
1200 4341	41	1	10	51,85
1200 4342	42	1	10	51,85
1200 4343	43	1	10	51,85
1200 4344	44	1	10	51,85
1200 4345	45	1	10	51,85
1200 4346	46	1	10	51,85
1200 4347	47	1	10	51,85

ZAPATO PIEL NO METAL / CHAUSSURE DE SÉCURITÉ NOIRE / BLACK SAFETY SHOE / SCARPA NERA SICUREZZA / SAPATO PRETO SEGURANÇA

**Mod. APOLO**



**S3 + SRC  
EN ISO 20345: 2011**

Puntera carbón light.  
Pointe carbone light.  
Carbon light toe.  
Puntale in carbonio leggero.  
Biqueira carbono light.

Plantilla Antiperforación Flex.  
Semelle antiperforation Flex.  
Flex anti-perforation insole.  
Soletta antiperforazione fless.  
Palmilha anti-perfuração Flex.

ES Plantilla anatómica, antisudor y antiestática.  
FR Semelle anatomique antisueur et antistatique.  
EN Antistatic, anti-sweating, anatomical insole.  
IT Soletta anatomica, antisudore e antiestatica.  
PT Palmilha anatómica, anti-suor e antiestática.

Ref				
1200 4936	36	1	10	70,30
1200 4937	37	1	10	70,30
1200 4938	38	1	10	70,30
1200 4939	39	1	10	70,30
1200 4940	40	1	10	70,30
1200 4941	41	1	10	70,30
1200 4942	42	1	10	70,30
1200 4943	43	1	10	70,30
1200 4944	44	1	10	70,30
1200 4945	45	1	10	70,30
1200 4946	46	1	10	70,30
1200 4947	47	1	10	70,30



BOTA PIEL NEGRO CIERRE VELCRO / BOTTE PEAU NOIRE FERMETURE VELCRO / BLACK LEATHER BOOT HOOK & LOOP FASTENER  
STIVALETTO PELLE NERA, CHIUSURA IN VELTRO / BOTA PELE PRETA FECHO VELCRO

**Mod. URIAN**



**S3 + SRC**  
**EN ISO 20345: 2011**  
**CAT II**

- ES Plantilla anatómica, antisudor y antiestática.
- FR Semelle anatomique antisueur et antistatique.
- EN Antistatic, anti-sweating, anatomical insole.
- IT Soletta anatomica, antisudore e antiestatica.
- PT Palmilha anatómica, anti-suor e antiestática.



Puntera carbón light  
Pointe carbone light.  
Carbon light toe.  
Puntale in carbonio leggero.  
Biqueira carbono light.



Reflectante.  
Réfléchissante.  
Reflective.  
Catarifrangente.  
Reflexivo.

Ref				
1200 4536	36	1	10	54,90
1200 4537	37	1	10	54,90
1200 4538	38	1	10	54,90
1200 4539	39	1	10	54,90
1200 4540	40	1	10	54,90
1200 4541	41	1	10	54,90
1200 4542	42	1	10	54,90
1200 4543	43	1	10	54,90
1200 4544	44	1	10	54,90
1200 4545	45	1	10	54,90
1200 4546	46	1	10	54,90
1200 4547	47	1	10	54,90

BOTA PIEL NEGRO / BOTTE PEAU NOIRE / BLACK LEATHER BOOT / STIVALETTO PELLE NERA / BOTA PELE PRETA

**Mod. ISKUR**



**S3 + SRC**  
**EN ISO 20345: 2011**  
**CAT II**

- ES Plantilla anatómica, antisudor y antiestática.
- FR Semelle anatomique antisueur et antistatique.
- EN Antistatic, anti-sweating, anatomical insole.
- IT Soletta anatomica, antisudore e antiestatica.
- PT Palmilha anatómica, anti-suor e antiestática.



Puntera carbón light  
Pointe carbone light.  
Carbon light toe.  
Puntale in carbonio leggero.  
Biqueira carbono light.



Reflectante.  
Réfléchissante.  
Reflective.  
Catarifrangente.  
Reflexivo.

Ref				
1200 4436	36	1	10	52,06
1200 4437	37	1	10	52,06
1200 4438	38	1	10	52,06
1200 4439	39	1	10	52,06
1200 4440	40	1	10	52,06
1200 4441	41	1	10	52,06
1200 4442	42	1	10	52,06
1200 4443	43	1	10	52,06
1200 4444	44	1	10	52,06
1200 4445	45	1	10	52,06
1200 4446	46	1	10	52,06
1200 4447	47	1	10	52,06





**BOTA PIEL NO METAL / BOTTE DE SECURITE NOIRE / BLACK SAFETY BOOT / STIVALE NERO DI SICUREZZA / BOTA PRETA SEGURANÇA**

**Mod. DAFNE**



**S3 + SRC**  
**EN ISO 20345: 2011**  
**CAT II**

Puntera carbón light.  
Pointe carbone light.  
Carbon light toe.  
Puntale in carbonio leggero.  
Biqueira carbono light.

Plantilla Antiperforación Flex.  
Semelle antiperforation Flex.  
Flex anti-perforation insole.  
Soletta antiperforazione fless.  
Palmilha anti-perfuração Flex.

ES Plantilla anatómica, antisudor y antiestática.  
FR Semelle anatomique antisueur et antistatique.  
EN Antistatic, anti-sweating, anatomical insole.  
IT Soletta anatomica, antisudore e antistatica.  
PT Palmilha anatómica, anti-suor e antiestática.

Ref				
1200 5036	36	1	10	72,95
1200 5037	37	1	10	72,95
1200 5038	38	1	10	72,95
1200 5039	39	1	10	72,95
1200 5040	40	1	10	72,95
1200 5041	41	1	10	72,95
1200 5042	42	1	10	72,95
1200 5043	43	1	10	72,95
1200 5044	44	1	10	72,95
1200 5045	45	1	10	72,95
1200 5046	46	1	10	72,95
1200 5047	47	1	10	72,95

**BOTA SERRAJE GRIS S-3 / BOTTE DE SÉCURITÉ GRIS S-3 / GREY SPLIT LEATHER GLOVE S-3  
STIVALE GRIGIO SCAMOSCIATO S-3 / BOTA DE CAMURÇA CINZA S-3**

**Mod. ARION**



**S3 + SRC**  
**EN ISO 20345: 2011**  
**CAT II**

Puntera carbón light.  
Pointe carbone light.  
Carbon light toe.  
Puntale in carbonio leggero.  
Biqueira carbono light.

ES Plantilla anatómica, antisudor y antiestática.  
FR Semelle anatomique antisueur et antistatique.  
EN Antistatic, anti-sweating, anatomical insole.  
IT Soletta anatomica, antisudore e antistatica.  
PT Palmilha anatómica, anti-suor e antiestática.

Ref				
1200 4238	38	1	10	57,60
1200 4239	39	1	10	57,60
1200 4240	40	1	10	57,60
1200 4241	41	1	10	57,60
1200 4242	42	1	10	57,60
1200 4243	43	1	10	57,60
1200 4244	44	1	10	57,60
1200 4245	45	1	10	57,60
1200 4246	46	1	10	57,60
1200 4247	47	1	10	57,60



ZAPATO SERRAJE GRIS / CHAUSSURE DE TRAVAIL GRIS / GREY SUEDE SHOE / SCARPA SCAMOSCIATA GRIGIA / SAPATO CAMURÇA CINZA

Mod. MYRON



Puntera carbón light.  
Pointe carbone light.  
Carbon light toe.  
Puntale in carbonio leggero.  
Biqueira carbono light.



Reflectante.  
Réfléchissante.  
Reflective.  
Catarifrangente.  
Reflexivo.



S1P + SRC  
EN ISO 20345: 2011  
CAT II

ES Plantilla anatómica, antisudor y antiestática.  
FR Semelle anatomique antisueur et antistatique.  
EN Antistatic, anti-sweating, anatomical insole.  
IT Soletta anatomica, antisudore e antistatica.  
PT Palmilha anatómica, anti-suor e antiestática.

Ref				
1200 4136	36	1	10	50,16
1200 4137	37	1	10	50,16
1200 4138	38	1	10	50,16
1200 4139	39	1	10	50,16
1200 4140	40	1	10	50,16
1200 4141	41	1	10	50,16
1200 4142	42	1	10	50,16
1200 4143	43	1	10	50,16
1200 4144	44	1	10	50,16
1200 4145	45	1	10	50,16
1200 4146	46	1	10	50,16
1200 4147	47	1	10	50,16

SANDALIA SERRAJE GRIS / SANDALE DE TRAVAIL GRISE / GREY SUEDE SAFETY SANDAL / SANDALO SCAMOSCIATO GRIGIO / SANDÁLIA CAMURÇA CINZA

Mod. PETRINA



Reflectante.  
Réfléchissante.  
Reflective.  
Catarifrangente.  
Reflexivo.



S1P + SRC  
EN ISO 20345: 2011  
CAT II

ES Plantilla anatómica, antisudor y antiestática.  
FR Semelle anatomique antisueur et antistatique.  
EN Antistatic, anti-sweating, anatomical insole.  
IT Soletta anatomica, antisudore e antistatica.  
PT Palmilha anatómica, anti-suor e antiestática.

Ref				
1200 4636	36	1	10	51,80
1200 4637	37	1	10	51,80
1200 4638	38	1	10	51,80
1200 4639	39	1	10	51,80
1200 4640	40	1	10	51,80
1200 4641	41	1	10	51,80
1200 4642	42	1	10	51,80
1200 4643	43	1	10	51,80
1200 4644	44	1	10	51,80
1200 4645	45	1	10	51,80
1200 4646	46	1	10	51,80
1200 4647	47	1	10	51,80

ZAPATO DEPORTIVO "NO METAL PROTECT" / CHAUSSURE DE SPORT / SPORT SHOE / SCARPA SPORTIVA / SAPATO DESPORTIVO

Mod. CLAU



Puntera carbón light.  
Pointe carbone light.  
Carbon light toe.  
Puntale in carbonio leggero.  
Biqueira carbono light.



Plantilla Antiperforación Flex.  
Semelle antiperforation Flex.  
Flex anti-perforation insole.  
Soletta antiperforazione fless.  
Palmilha anti-perfuração Flex.



S3 + SRC  
EN ISO 20345: 2011  
CAT II

ES Plantilla anatómica, antisudor y antiestática.  
FR Semelle anatomique antisueur et antistatique.  
EN Antistatic, anti-sweating, anatomical insole.  
IT Soletta anatomica, antisudore e antistatica.  
PT Palmilha anatómica, anti-suor e antiestática.

Ref					Ref				
1200 4735	35	1	10	101,40	1200 4742	42	1	10	101,40
1200 4736	36	1	10	101,40	1200 4743	43	1	10	101,40
1200 4737	37	1	10	101,40	1200 4744	44	1	10	101,40
1200 4738	38	1	10	101,40	1200 4745	45	1	10	101,40
1200 4739	39	1	10	101,40	1200 4746	46	1	10	101,40
1200 4740	40	1	10	101,40	1200 4747	47	1	10	101,40
1200 4741	41	1	10	101,40	1200 4748	48	1	10	101,40



ZAPATO DEPORTIVO S1P SRC AZ "NO METAL" / CHAUSSURE DE SPORT S1P SRC BLE "NON-MÉTAL" / SPORT SHOE S1P SRC BLU "NO METAL"  
SCARPA SPORTIVA S1P SRC BLU "NON METALLO" / SAPATO DESPORTIVO S1P SRC AZUL "SEM METAL"

Mod. SOLANA



S1P + SRC  
EN ISO 20345:2011  
CAT II

PLANTILLA ANTIPERFORACIÓN TEXTIL	PUNTERA PLÁSTICA COMPOSITE	METAL FREE	CORTE MICRO FIBRA
SUELA ANTISLIP	SUELA MONO DENSIDAD	PLANTILLA AIR VENT	

Ref				
1200 5135	35	1	10	71,75
1200 5136	36	1	10	71,75
1200 5137	37	1	10	71,75
1200 5138	38	1	10	71,75
1200 5139	39	1	10	71,75
1200 5140	40	1	10	71,75
1200 5141	41	1	10	71,75
1200 5142	42	1	10	71,75
1200 5143	43	1	10	71,75
1200 5144	44	1	10	71,75
1200 5145	45	1	10	71,75
1200 5146	46	1	10	71,75
1200 5147	47	1	10	71,75

ZAPATO DEPORTIVO S1P SRC NE "NO METAL" / CHAUSSURE DE SPORT S1P SRC NO "NON-MÉTAL" / SPORT SHOE S1P SRC BLA "NO METAL"  
SCARPA SPORTIVA S1P SRC NE "NON METALLO" / SAPATO DESPORTIVO S1P SRC PRETO "SEM METAL"

Mod. SOLANA



S1P + SRC  
EN ISO 20345:2011  
CAT II

PLANTILLA ANTIPERFORACIÓN TEXTIL	PUNTERA PLÁSTICA COMPOSITE	METAL FREE	CORTE MICRO FIBRA
SUELA ANTISLIP	SUELA MONO DENSIDAD	PLANTILLA AIR VENT	

Ref				
1200 5235	35	1	10	71,75
1200 5236	36	1	10	71,75
1200 5237	37	1	10	71,75
1200 5238	38	1	10	71,75
1200 5239	39	1	10	71,75
1200 5240	40	1	10	71,75
1200 5241	41	1	10	71,75
1200 5242	42	1	10	71,75
1200 5243	43	1	10	71,75
1200 5244	44	1	10	71,75
1200 5245	45	1	10	71,75
1200 5246	46	1	10	71,75
1200 5247	47	1	10	71,75

ZAPATO DEPORTIVO S3 SRC "NO METAL" / CHAUSSURE DE SPORT S3 SRC NO "NON-MÉTAL" / SPORT SHOE S3 SRC "NO METAL"  
SCARPA SPORTIVA S3 SRC NE "NON METALLO" / SAPATO DESPORTIVO S3P SRC MOD. ALHAMBRA "SEM METAL"

**Mod. ALHAMBRA**



**S3 + SRC**  
**EN ISO 20345:2011**  
**CAT II**

- PLANTILLA ANTIPERFORACIÓN TEXTIL
- PUNTERA PLÁSTICA COMPOSITE
- METAL FREE
- CORTE MICRO FIBRA
- SUELA ANTISLIP
- SUELA MONO DENSIDAD
- PLANTILLA AIR VENT



Ref				
1200 5335	35	1	10	78,31
1200 5336	36	1	10	78,31
1200 5337	37	1	10	78,31
1200 5338	38	1	10	78,31
1200 5339	39	1	10	78,31
1200 5340	40	1	10	78,31
1200 5341	41	1	10	78,31
1200 5342	42	1	10	78,31
1200 5343	43	1	10	78,31
1200 5344	44	1	10	78,31
1200 5345	45	1	10	78,31
1200 5346	46	1	10	78,31
1200 5347	47	1	10	78,31

ZAPATO DEPORTIVO S3 SRC ESD "NO METAL" / CHAUSSURE DE SPORT S3 SRC ESD NO "NON-MÉTAL" / SPORT SHOE S3 SRC ESD "NO METAL"  
SCARPA SPORTIVA S3 SRC ESD NE "NON METALLO" / SAPATO DEPORT S3 SRC ESD "SEM METAL"

**Mod. MONTIEL**



**S3 + SRC**  
**EN ISO 20345:2011**  
**CAT II**

- PLANTILLA ANTIPERFORACIÓN TEXTIL
- PUNTERA PLÁSTICA COMPOSITE
- METAL FREE
- CORTE MICRO FIBRA
- SUELA ANTISLIP
- SUELA MONO DENSIDAD
- PLANTILLA AIR VENT



Ref				
1200 5435	35	1	10	82,41
1200 5436	36	1	10	82,41
1200 5437	37	1	10	82,41
1200 5438	38	1	10	82,41
1200 5439	39	1	10	82,41
1200 5440	40	1	10	82,41
1200 5441	41	1	10	82,41
1200 5442	42	1	10	82,41
1200 5443	43	1	10	82,41
1200 5444	44	1	10	82,41
1200 5445	45	1	10	82,41
1200 5446	46	1	10	82,41
1200 5447	47	1	10	82,41



BOTA DE AGUA PVC, CON RECUBRIMIENTO INTERIOR DE PUNTO / BOTTE DE PLUIE EN PVC, DOUBLURE INTERIEURE MAILLE  
PVC RAINBOOTS FOR WORK AND LEISURE, DOTH INNER LINING / STIVALE D'ACQUA IN PVC  
BOTA DE ÁGUA PVC, REVESTIDA DE FORRO INTERIOR

**MOD. RUIDERA  
OB E SRA  
EN ISO 20347: 2012  
CAT II**



Ref					
1200 1636	■	36	1	10	13,90
1200 1637	■	37	1	10	13,90
1200 1638	■	38	1	10	13,90
1200 1639	■	39	1	10	13,90
1200 1640	■	40	1	10	13,90
1200 1641	■	41	1	10	13,90
1200 1642	■	42	1	10	13,90
1200 1643	■	43	1	10	13,90
1200 1644	■	44	1	10	13,90
1200 1645	■	45	1	10	13,90
1200 1646	■	46	1	10	13,90
1200 1647	■	47	1	10	13,90
1200 1648	■	48	1	10	13,90
*1200 1649	■	49	1	10	18,50
*1200 1650	■	50	1	10	18,50

\* Tallas especiales / Special sizes

**MOD. RUIDERA  
OB E SRA  
EN ISO 20347: 2012  
CAT II**



Ref					
1200 1736	■	36	1	10	17,50
1200 1737	■	37	1	10	17,50
1200 1738	■	38	1	10	17,50
1200 1739	■	39	1	10	17,50
1200 1740	■	40	1	10	17,50
1200 1741	■	41	1	10	17,50
1200 1742	■	42	1	10	17,50
1200 1743	■	43	1	10	17,50
1200 1744	■	44	1	10	17,50
1200 1745	■	45	1	10	17,50
1200 1746	■	46	1	10	17,50
1200 1747	■	47	1	10	17,50
1200 1748	■	48	1	10	17,50

**MOD. COVADONGA  
OB E SRA  
EN ISO 20347: 2012  
CAT II**



Ref					
1200 2036	■	36	1	10	17,30
1200 2037	■	37	1	10	17,30
1200 2038	■	38	1	10	17,30
1200 2039	■	39	1	10	17,30
1200 2040	■	40	1	10	17,30
1200 2041	■	41	1	10	17,30
1200 2042	■	42	1	10	17,30
1200 2043	■	43	1	10	17,30
1200 2044	■	44	1	10	17,30
1200 2045	■	45	1	10	17,30
1200 2046	■	46	1	10	17,30
1200 2047	■	47	1	10	17,30



BOTA DE AGUA PVC ALTA CALIDAD, CON RECUBRIMIENTO INTERIOR DE PUNTO / BOTTE DE PLUIE EN PVC, DOUBLURE INTERIEURE MAILLE  
HIGH QUALITY PVC RAINBOOTS FOR WORK AND LEISURE, DOTH INNER LINING / STIVALE IN PVC PER L'ACQUA AD ALTA RESISTENZA, CON RIVESTIMENTO INTERNO  
BOTA DE ÁGUA PVC, ALTA QUALIDADE, REVESTIDA DE FORRO INTERIOR



SRC



**MOD. SERENA  
OB E SRC  
EN ISO 20347: 2012  
CAT II**

ALTA CALIDAD  
HIGH QUALITY

ES Suela antideslizante con shock absorber SRC.  
FR Semelle antidérapante avec 'choc absorber' SRC.  
EN Anti-slip sole unit with SRC shock absorption.  
IT Suola antiscivolo con assorbimento shock SRC.  
PT Sola antiderrapante com choque absorvente SRC.

Ref					
1200 2836	■	36	1	6	16,95
1200 2837	■	37	1	6	16,95
1200 2838	■	38	1	6	16,95
1200 2839	■	39	1	6	16,95
1200 2840	■	40	1	6	16,95
1200 2841	■	41	1	6	16,95
1200 2842	■	42	1	6	16,95
1200 2843	■	43	1	6	16,95
1200 2844	■	44	1	6	16,95
1200 2845	■	45	1	6	16,95
1200 2846	■	46	1	6	16,95
1200 2847	■	47	1	6	16,95
1200 2848	■	48	1	6	16,95



SRC



1200 2936	■	36	1	6	20,96
1200 2937	■	37	1	6	20,96
1200 2938	■	38	1	6	20,96
1200 2939	■	39	1	6	20,96
1200 2940	■	40	1	6	20,96
1200 2941	■	41	1	6	20,96
1200 2942	■	42	1	6	20,96
1200 2943	■	43	1	6	20,96
1200 2944	■	44	1	6	20,96
1200 2945	■	45	1	6	20,96
1200 2946	■	46	1	6	20,96
1200 2947	■	47	1	6	20,96
1200 2948	■	48	1	6	20,96

BOTA AGUA FORRO POLAR COSIDO / BOTTE DE PLUIE POLAIRE / RAINBOOTS WITH LINING  
STIVALE DI GOMMA IMBOTTITURA POLARE / BOTA DE AGUA COM FORRO POLAR COSIDO



**MOD. ESCARCHA  
OB E C1 SRC  
EN ISO 20347: 2012  
CAT II**

ALTA CALIDAD  
HIGH QUALITY



Ref				
1200 2636	36	1	6	48,31
1200 2637	37	1	6	48,31
1200 2638	38	1	6	48,31
1200 2639	39	1	6	48,31
1200 2640	40	1	6	48,31
1200 2641	41	1	6	48,31
1200 2642	42	1	6	48,31
1200 2643	43	1	6	48,31
1200 2644	44	1	6	48,31
1200 2645	45	1	6	48,31
1200 2646	46	1	6	48,31
1200 2647	47	1	6	48,31





BOTA DE AGUA PVC CON FORRO POLAR INTERIOR / BOTTE DE PLUIE PVC POLAIRE AVEC DOUBLURE INTÉRIEURE POLAIRE COUSUE  
WARON LINED PVC BOOT / STIVALE D'ACQUA PVC CON RIVESTIMENTO INTERNO / BOTA DE ÁGUA PVC, COM FORRO POLAR INTERIOR



**MOD. IBÓN  
OB E C1 SRC  
EN ISO 20347: 2012  
CAT II**



Ref				
1200 2136	36	1	10	30,76
1200 2137	37	1	10	30,76
1200 2138	38	1	10	30,76
1200 2139	39	1	10	30,76
1200 2140	40	1	10	30,76
1200 2141	41	1	10	30,76
1200 2142	42	1	10	30,76
1200 2143	43	1	10	30,76
1200 2144	44	1	10	30,76
1200 2145	45	1	10	30,76
1200 2146	46	1	10	30,76
1200 2147	47	1	10	30,76

BOTAS DE AGUA PVC CON PUNTERA ALTA SEGURIDAD / BOTTES DE PLUIE POINTE EN PVC / PVC RAINBOOTS FOR WORK WITH STEEL TOE CAP  
STIVALE D'ACQUA CON PUNTA E SUOLA IN ACCIAIO IN PVC / BOTAS DE ÁGUA PVC COM BIQUEIRA



**MOD. SANABRIA  
S4 / SRA  
EN ISO 20345: 2011  
CAT II**



ES USO: Resistente a aceites y grasas animales.

FR UTILISATION: Résistante à l'huile et aux matières grasses animales.

EN USE: Resistant to oils and animal fats.

IT USO: Resistente a oli e grassi animali.

PT UTILIZAÇÃO: Resistente a óleos e a gordura animal.

Ref				
1200 1938	38	1	6	33,48
1200 1939	39	1	6	33,48
1200 1940	40	1	6	33,48
1200 1941	41	1	6	33,48
1200 1942	42	1	6	33,48
1200 1943	43	1	6	33,48
1200 1944	44	1	6	33,48
1200 1945	45	1	6	33,48
1200 1946	46	1	6	33,48
1200 1947	47	1	6	33,48

BOTA DE AGUA BLANCA PVC / BOTTE DE PLUIE BLANCHE EN PVC / PVC WHITE RAINBOOTS FOR WORK AND LEISURE  
STIVALE D'ACQUA BIANCO IN PVC / BOTA DE ÁGUA BRANCA PVC

**MOD. SERENA  
OB E SRC  
EN ISO 20347: 2012  
CAT II**



Ref				
1200 1756	36	1	10	28,95
1200 1757	37	1	10	28,95
1200 1758	38	1	10	28,95
1200 1759	39	1	10	28,95
1200 1760	40	1	10	28,95
1200 1761	41	1	10	28,95
1200 1762	42	1	10	28,95
1200 1763	43	1	10	28,95
1200 1764	44	1	10	28,95
1200 1765	45	1	10	28,95
1200 1766	46	1	10	28,95
1200 1767	47	1	10	28,95

BOTA DE AGUA ALTA SEGUR. S-5 / BOTTE PLUIE HAUTE SEGUR. S-5 / RAINBOOTS STEEL TOE CAP S-5  
STIVALE DI GOMMA ALTA SICUR. S-5 / BOTA AGUA C/BIQUEIRA, PALMIHA S-5



**MOD. ALBUFERA**  
**S5 / SRA**  
**EN ISO 20345: 2011**  
**CAT II**



Ref					
1200 1538	■	38	1	6	30,85
1200 1539	■	39	1	6	30,85
1200 1540	■	40	1	6	30,85
1200 1541	■	41	1	6	30,85
1200 1542	■	42	1	6	30,85
1200 1543	■	43	1	6	30,85
1200 1544	■	44	1	6	30,85
1200 1545	■	45	1	6	30,85
1200 1546	■	46	1	6	30,85
1200 1547	■	47	1	6	30,85
1200 1548	■	48	1	6	30,85



Ref					
1200 3236	■	36	1	6	31,15
1200 3237	■	37	1	6	31,15
1200 3238	■	38	1	6	31,15
1200 3239	■	39	1	6	31,15
1200 3240	■	40	1	6	31,15
1200 3241	■	41	1	6	31,15
1200 3242	■	42	1	6	31,15
1200 3243	■	43	1	6	31,15
1200 3244	■	44	1	6	31,15
1200 3245	■	45	1	6	31,15
1200 3246	■	46	1	6	31,15
1200 3247	■	47	1	6	31,15
1200 3248	■	48	1	6	31,15
*1200 3249	■	49	1	6	36,70
*1200 3250	■	50	1	6	36,70

\* Tallas especiales / Special sizes



Ref					
1200 3336	■	36	1	6	32,60
1200 3337	■	37	1	6	32,60
1200 3338	■	38	1	6	32,60
1200 3339	■	39	1	6	32,60
1200 3340	■	40	1	6	32,60
1200 3341	■	41	1	6	32,60
1200 3342	■	42	1	6	32,60
1200 3343	■	43	1	6	32,60
1200 3344	■	44	1	6	32,60
1200 3345	■	45	1	6	32,60
1200 3346	■	46	1	6	32,60
1200 3347	■	47	1	6	32,60
1200 3348	■	48	1	6	32,60



BOTAS VADEADOR PVC / BOTTES DE PÊCHE / PVC WORK CHEST WADER / STIVALE WADERS PVC / BOTAS PVC WADER

**MOD. PEÑARROYA**



Ref				
1200 3539	39	1	8	108,03
1200 3540	40	1	8	108,03
1200 3541	41	1	8	108,03
1200 3542	42	1	8	108,03
1200 3543	43	1	8	108,03
1200 3544	44	1	8	108,03
1200 3545	45	1	8	108,03
1200 3546	46	1	8	108,03
1200 3547	47	1	8	108,03

BOTAS PVC MUSLO / CUISSARDES PVC / PVC WORK THIGH BOOT / STIVALI-COSCIA PVC / BOTAS PVC COXA

**MOD. ORELLANA**



Ref				
1200 3439	39	1	10	70,55
1200 3440	40	1	10	70,55
1200 3441	41	1	10	70,55
1200 3442	42	1	10	70,55
1200 3443	43	1	10	70,55
1200 3444	44	1	10	70,55
1200 3445	45	1	10	70,55
1200 3446	46	1	10	70,55
1200 3447	47	1	10	70,55

BOTA DE AGUA BAJA / UNE EAU ÉMOUSSÉE BAISSÉ / BOOT WATERS DOWN FALL / STIVALI BASSA MAREA / BOTA DE ÁGUA BAIXA



**MOD. ROCÍO  
SBH A-E-P-FO SRA  
EN ISO 20345: 2011  
CAT II**

ES USO: Industria, construcción, estaciones de servicio, lavaderos, etc.

FR UTILISATION: Industrie, construction, stations service, lavage de voiture, etc.

EN USE: Industry, building, petrol stations, car washing, etc.

IT USO: Industria, costruzioni, stazioni di servizio, lavelli, etc.

PT UTILIZAÇÃO: Indústria, construção, estações de serviço, lavagem de automóveis, etc.

Ref				
1200 2237	37	1	6	55,09
1200 2238	38	1	6	55,09
1200 2239	39	1	6	55,09
1200 2240	40	1	6	55,09
1200 2241	41	1	6	55,09
1200 2242	42	1	6	55,09
1200 2243	43	1	6	55,09
1200 2244	44	1	6	55,09
1200 2245	45	1	6	55,09
1200 2246	46	1	6	55,09
1200 2247	47	1	6	55,09
1200 2248	48	1	6	55,09

BOTA PIEL FORRADA SEGURIDAD S3 / BOTTE PEAU DOUBLEE SÉCURITÉ S3  
SAFETY LINED BOOTS S3 / STIVALE DI SICUREZZA IN PELLE FODERATA S3 / BOTA SEGURANÇA FORRADA EM PELE



**Mod. MEGAN  
S3 / SRC  
EN ISO 20345:2011**

ES Plantilla anatómica, antisuador y antiestática.

FR Semelle anatomique antisueur et antistatique.

EN Antistatic, anti-sweating, anatomical insole.

IT Soletta anatomica, antisuadore e antiestatica.

PT Palmilha anatómica, anti-suor e antiestática.

<b>PLANTILLA ANTIPERFORACIÓN TEXTIL</b>	<b>PUNTERA PLÁSTICA COMPOSITE</b>	<b>METAL FREE</b>	<b>SUELA ANTISLIP</b>	<b>SUELA MONO DENSIDAD</b>
-------------------------------------------------	-------------------------------------------	-----------------------	---------------------------	------------------------------------



Forro polar / Polar lining

Ref				
1200 2437	37	1	10	103,70
1200 2438	38	1	10	103,70
1200 2439	39	1	10	103,70
1200 2440	40	1	10	103,70
1200 2441	41	1	10	103,70
1200 2442	42	1	10	103,70

Ref				
1200 2443	43	1	10	103,70
1200 2444	44	1	10	103,70
1200 2445	45	1	10	103,70
1200 2446	46	1	10	103,70
1200 2447	47	1	10	103,70



ZAPATO TRABAJO SERRAJE / CHAUSSURES DE TRAVAIL EN CUIR / SUEDE WORKING SHOES  
SCARPA DA LAVORO IN CAMOSCIO / SAPATO TRABALHO CAMURÇA

**MOD. ESTERO**



Ref					
1250 2539	39	1	23	<b>23,75</b>	
1250 2540	40	1	23	<b>23,75</b>	
1250 2541	41	1	23	<b>23,75</b>	
1250 2542	42	1	23	<b>23,75</b>	
1250 2543	43	1	23	<b>23,75</b>	
1250 2544	44	1	23	<b>23,75</b>	
1250 2545	45	1	23	<b>23,75</b>	
1250 2546	46	1	23	<b>23,75</b>	

ES Zapato de trabajo en piel de serraje con forro de tela y piso de caucho.  
FR Chaussures de travail en cuir avec doublure en tissu et semelle de caoutchouc.  
EN Suede working shoes with textile lining and rubber sole.  
IT Scarpa da lavoro in pelle scamosciata con fodera in tessuto e suola in gomma.  
PT Sapato trabalho em pele de camurça com forro têxtil e revestimento de borracha.

BOTA TRABAJO SERRAJE / BOTTE DE TRAVAIL EN CUIR / SUEDE WORKING BOOTS / STIVALE DA LAVORO IN CAMOSCIO / BOTA DE TRABALHO EM CAMURÇA

**MOD. DELTA**



Ref					
1250 2439	39	1	23	<b>24,45</b>	
1250 2440	40	1	23	<b>24,45</b>	
1250 2441	41	1	23	<b>24,45</b>	
1250 2442	42	1	23	<b>24,45</b>	
1250 2443	43	1	23	<b>24,45</b>	
1250 2444	44	1	23	<b>24,45</b>	
1250 2445	45	1	23	<b>24,45</b>	
1250 2446	46	1	23	<b>24,45</b>	

ES Bota de trabajo en piel de serraje con forro de tela y piso de caucho.  
FR Botte de travail en cuir avec doublure en tissu et semelle de caoutchouc.  
EN Suede working boots with textile lining and rubber sole.  
IT Stivale da lavoro in pelle scamosciata con fodera in tessuto e suola in gomma.  
PT Bota de trabalho em couro de camurça com forro têxtil e revestimento de borracha.

BOTA SERRAJE LONA / BOTTE EN CUIR CIREE / SUEDE - CANVAS BOOTS / STIVALE IN CAMOSCIO / BOTA CAMURÇA E LONA

**MOD. MANGLAR**



Ref					
1250 2239	39	1	23	<b>28,35</b>	
1250 2240	40	1	23	<b>28,35</b>	
1250 2241	41	1	23	<b>28,35</b>	
1250 2242	42	1	23	<b>28,35</b>	
1250 2243	43	1	23	<b>28,35</b>	
1250 2244	44	1	23	<b>28,35</b>	
1250 2245	45	1	23	<b>28,35</b>	
1250 2246	46	1	23	<b>28,35</b>	

ES Bota de piel serraje y lona, con forro de tela y piso de caucho.  
FR Botte en cuir cirée, avec doublure en tissu et semelle en caoutchouc.  
EN Suede and canvas boots with textile lining and rubber sole.  
IT Stivale di pelle scamosciata e tela, con fodera in tessuto e suola in gomma.  
PT Bota de couro camurça e lona com forro têxtil e revestimento de borracha.

BOTA DE SERRAJE CREMALLERA / BOTTE EN CUIR AVEC FERMETURE ECLAIR / SUEDE BOOT WITH ZIP  
STIVALE IN CAMOSCIO CON ZIP / BOTA DE CAMURÇA COM FECHO

**MOD. CARONA**



Ref					
1250 2039	39	1	15	<b>34,99</b>	
1250 2040	40	1	15	<b>34,99</b>	
1250 2041	41	1	15	<b>34,99</b>	
1250 2042	42	1	15	<b>34,99</b>	
1250 2043	43	1	15	<b>34,99</b>	
1250 2044	44	1	15	<b>34,99</b>	
1250 2045	45	1	15	<b>34,99</b>	
1250 2046	46	1	15	<b>34,99</b>	

ES Bota de piel serraje con cremallera, forro de borreguillo y piso de caucho.  
FR Botte en cuir avec fermeture éclair, doublure molletonné et semelle en caoutchouc.  
EN Suede leather boots with zipper, fleece lining and rubber sole.  
IT Stivale di pelle scamosciata con cerniera lampo, rivestimento interno in pile e suola in gomma.  
PT Bota de couro em camurça, com fecho, forro de lã e revestimento de borracha.



ZAPATILLA TREKKING / CHAUSSURES TREKKING / TREKKING SHOES / SCARPE DA TREKKING / SAPATOS TREKKING



MOD. IREGUA

Ref				
1250 2638	38	1	15	<b>62,99</b>
1250 2639	39	1	15	<b>62,99</b>
1250 2640	40	1	15	<b>62,99</b>
1250 2641	41	1	15	<b>62,99</b>
1250 2642	42	1	15	<b>62,99</b>
1250 2643	43	1	15	<b>62,99</b>
1250 2644	44	1	15	<b>62,99</b>
1250 2645	45	1	15	<b>62,99</b>
1250 2646	46	1	15	<b>62,99</b>

- ES Zapatilla Deportiva Trekking con cordones fabricada en piel serraje de color marrón y forro de Velour marrón.
- FR Chaussures Trekking sport avec lacets en cuir marron et doublure de velours marron.
- EN Sports Trekking lace, made of suede leather brown and velour brown lining.
- IT Scarpe sportive da Trekking con lacci, fabbricata in crosta, di colore marrone e fodera marrone in Velour.
- PT Sapato Desportivo Trekking com cordões feito de pele de camurça em cor castanha e forro de veludo castanho.

BOTA PIEL CON CORDONES / BOTTE CUIR À LACETS / LEATHER BOOT WITH LACES / BOTA EM COURO COM CORDÕES / STIVALE IN PELLE CON LACCI



MOD. MORELLA

Ref				
1250 3238	38	1	15	<b>47,15</b>
1250 3239	39	1	15	<b>47,15</b>
1250 3240	40	1	15	<b>47,15</b>
1250 3241	41	1	15	<b>47,15</b>
1250 3242	42	1	15	<b>47,15</b>
1250 3243	43	1	15	<b>47,15</b>
1250 3244	44	1	15	<b>47,15</b>
1250 3245	45	1	15	<b>47,15</b>
1250 3246	46	1	15	<b>47,15</b>

- ES Cordones en piel de serraje color Camel, forro interior Cambrelle®, lengüeta con fuelle y suela de caucho en color "caramelo".
- FR Lacets en cuir couleur Camel, doublure intérieur Cambrelle®, languette avec soufflet et semelle en caoutchouc couleur "caramel".
- EN Camel suede leather cords, Cambrelle® interior lining, bellows tongue and "caramel" rubber sole.
- IT Cordões em pele camurça, cor Camel, forro interior Cambrelle®, lingueta reforçada e sola de borracha em cor "caramelo".
- PT Lacci in pelle color cammello, rivestimento interno Cambrelle®, linguetta rinforzata e suola in gomma color "caramello".

BOTA TREKKING VERDE / BOTTE TREKKING VERTE / GREEN TREKKING BOOTS / STIVALE VERDE DA TREKKING / BOTA TREKKING VERDE



MOD. ALHAMA

Ref				
1250 3339	39	1	15	<b>52,90</b>
1250 3340	40	1	15	<b>52,90</b>
1250 3341	41	1	15	<b>52,90</b>
1250 3342	42	1	15	<b>52,90</b>
1250 3343	43	1	15	<b>52,90</b>
1250 3344	44	1	15	<b>52,90</b>
1250 3345	45	1	15	<b>52,90</b>
1250 3346	46	1	15	<b>52,90</b>

- ES Bota trekking en serraje con forro de tela, plantilla confort y piso de caucho.
- FR Botte trekking en cuir avec doublure en tissu, semelle en caoutchouc très confortable.
- EN Suede trekking boots with textile lining, comfort midsole and rubber sole.
- IT Stivale da trekking in pelle scamosciata con fodera in tessuto. Modello suola confortevole e speciale.
- PT Bota trekking em camurça com forro têxtil, palmilha cómoda e revestimento de borracha.

BOTA TREKKING MARRÓN / BOTTE TREKKING MARRON / BROWN TREKKING BOOTS / STIVALE MARRONE DA TREKKING / BOTA TREKKING CASTANHA



MOD. ODIEL

Ref				
1250 3539	39	1	15	<b>52,90</b>
1250 3540	40	1	15	<b>52,90</b>
1250 3541	41	1	15	<b>52,90</b>
1250 3542	42	1	15	<b>52,90</b>
1250 3543	43	1	15	<b>52,90</b>
1250 3544	44	1	15	<b>52,90</b>
1250 3545	45	1	15	<b>52,90</b>
1250 3546	46	1	15	<b>52,90</b>

- ES Bota trekking en serraje con forro de tela, plantilla confort y piso de caucho.
- FR Botte trekking en cuir avec doublure en tissu, semelle en caoutchouc très confortable.
- EN Suede trekking boots with textile lining, comfort midsole and rubber sole.
- IT Stivale da trekking in pelle scamosciata con fodera in tessuto. Modello suola confortevole e speciale.
- PT Bota trekking em camurça com forro têxtil, palmilha cómoda e revestimento de borracha.



BOTA TREKKING SERRAJE / BOTTE TREKKING EN CUIR / SUEDE TREKKING BOOTS / STIVALE DA TREKKING IN CAMOSCIO

MOD. NIJAR



Ref					
1250 3139	39	1	15	<b>75,45</b>	
1250 3140	40	1	15	<b>75,45</b>	
1250 3141	41	1	15	<b>75,45</b>	
1250 3142	42	1	15	<b>75,45</b>	
1250 3143	43	1	15	<b>75,45</b>	
1250 3144	44	1	15	<b>75,45</b>	
1250 3145	45	1	15	<b>75,45</b>	
1250 3146	46	1	15	<b>75,45</b>	
1250 3147	47	1	15	<b>75,45</b>	
1250 3148	48	1	15	<b>75,45</b>	

- ES Bota trekking en serraje con forro de velour, plantilla confort y suela especial.
- FR Botte trekking en cuir avec doublure en velour, confortable du à sa semelle spéciale.
- EN Suede trekking boots with velour lining, comfort midsole and special sole.
- IT Stivale da trekking in pelle scamosciata con rivestimento in velluto. Modello suola confortevole e speciale.
- PT Bota trekking em camurça com forro de veludo, palmilha cómoda e sola especial.

BOTA TREKKING MARRÓN HIDRÓFUGA / BOTTE TREKKING MARRON HYDROFUGE / BROWN TREKKING WATER RESISTANT BOOTS  
STIVALE MARRONE DA TREKKING IFROREPELLENTI / BOTA TREKKING CASTANHA RESISTENTES Á ÁGUA



MOD. SELLA

Ref					
1250 3939	39	1	15	<b>86,90</b>	
1250 3940	40	1	15	<b>86,90</b>	
1250 3941	41	1	15	<b>86,90</b>	
1250 3942	42	1	15	<b>86,90</b>	
1250 3943	43	1	15	<b>86,90</b>	
1250 3944	44	1	15	<b>86,90</b>	
1250 3945	45	1	15	<b>86,90</b>	
1250 3946	46	1	15	<b>86,90</b>	
1250 3947	47	1	15	<b>86,90</b>	
1250 3948	48	1	15	<b>86,90</b>	

- ES Bota Trekking de Piel Serraje hidrófuga con forro de Velour Marrón, cordones y suela especial de caucho inyectado. Especial protección contra la humedad.
- FR Botte Trekking en cuir hydrofuge avec doublure velours marron, lacets et semelle spéciale en caoutchouc. Protection spéciale contre l'humidité.
- EN Waterproof split leather trekking shoe, felted with brown velour, laces and special foot sole made of injected rubber. Special protection against humidity.
- IT Scarponcino da Trekkin in crosta, impermeabile, con fodera marrone in Velour, lacci e suola speciale iniettata in gomma. Speciale protezione contro l'umidità.
- PT Bota Trekking de Pele Camurça, impermeável com forro de veludo castanho, cordões e sola especial de borracha injetada. Proteção especial contra a humidade.

BOTA SYMPATEX / BOTTE SYMPATEX / SYMPATEX BOOTS / STIVALE SYMPATEX / BOTA SYMPATEX

MOD. CIMARRÓN



- ES Hidrofugados en color marrón. Esponjas protectoras en costuras, puntera y contrafuerte termoplásticos. Membrana Sympatex Outlast. Piso extrarresistente y antideslizante. Resiste el calor por contacto 300°C (60 segundos) Ojetes antioxidantes y ganchos con sistema autobloqueante, Nobuck y cordones hidrofugados.
- FR Hydrofuges marrons. Éponges protectrices au niveau des coutures, pointe et contrefort thermoplastiques. Membrane Sympatex Outlast. Semelle extra résistante et antidérapante. Résiste à la chaleur par contact 300°C (60 secondes) Boucles antioxydantes et crochets avec système autobloquant, Nobuck et lacets hydrofuges.
- EN Water proof boots brown color. sewing with protective sponges, thermoplastic toe and heel counter. sympatex outlast membrane. extra resistance and non slip insole. contact heats up to 300c° (60 second) antioxidant grommets, self-locking clamps and waterproof laces.
- IT Idrorepellenti, di colore marrone. Spugne protettive nelle cuciture, sul tacco e contrafforti termoplastici. Membrana Sympatex Outlast. Suola super-resistente e antiscivolo. Resistente al calore da contatto 300 °C (60 secondi). Occhielli antiossidanti e ganci con sistema autobloccante, Nobuck e lacci idrorepellenti.
- PT Impermeáveis em cor castanha. Esponjas de proteção nas costuras, biqueira e contraforte termoplásticos. Membrana Sympatex Outlast. Piso extra resistente e antiderrapante. Resiste por contato ao calor de 300 °C (60 segundos) ilhós antioxidantes e ganchos com sistema de autobloqueio, nobuk atacadores impermeáveis.

Ref					
1250 3739	39	1	12	<b>229,20</b>	
1250 3740	40	1	12	<b>229,20</b>	
1250 3741	41	1	12	<b>229,20</b>	
1250 3742	42	1	12	<b>229,20</b>	
1250 3743	43	1	12	<b>229,20</b>	
1250 3744	44	1	12	<b>229,20</b>	
1250 3745	45	1	12	<b>229,20</b>	
1250 3746	46	1	12	<b>229,20</b>	
1250 3747	47	1	12	<b>229,20</b>	





	ES	FR	EN	IT	PT
<b>Ref</b>	Referencia	Référence	Reference	Riferimento	Referência
	Unidad mínima de venta	Nombre d'unités minimum de vente	Minimum sale unit	Quantitativo minimo di vendita	Unidade mínima de venda
	Packing	Conditionnement	Packing	Imballo	Embalagem
	Precio	Prix	Price	Prezzo	Preço
	Blíster	Blister	Blister	Blister	Blister
	Longitud	Longueur	Length	Lunghezza	Comprimento
	Voltaje	Tension	Voltage	Tensione	Tensão
<b>CAT</b>	Categoría	Catégorie	Category	Categoria	Categoria
	Talla guantes	Taille des gants	Size of gloves	Taglia guanti	Tamanho luvas
	Contenido	Contenu	Contents	Contenuto	Conteúdo
	Medidas	Mesures	Measurements	Misure	Medidas
	Descripción	Description	Description	Descrizione	Descrição
	Colores	Couleur	Color	Colore	Cores
	Carga máxima	Charge maximum	Maximum load	Carga máxima	Carico massimo
	Talla	Taille	Size	Taglia	Tamanho
	Talla calzado	Taille des chaussures	Size of shoes	Taglia scarpe	Tamanho calçado







 cofan



[www.cofan.es](http://www.cofan.es)



# ÍNDICE / INDEX / CONTENTS

## INDICE / ÍNDICE



**422**

CILINDROS / CYLINDRES / CYLINDERS  
CILINDROS / CILINDROS



**445**

CAJAS DE SEGURIDAD / COFFRETS DE SÉCURITÉ  
SAFE BOXES / CASSETTE DI SICUREZZA  
COFRES DE SEGURANÇA



**428**

CERRADURAS / SERRURE / MORTISE LOCK  
SERRATURA / FECHADURA



**446**

MANIVELAS / POIGNEES / DOOR HANDLE  
MANIGLIA / MANIVELA



**438**

CIERRAPUERTAS / FERME-PORTES / DOOR CLOSER  
CHIUDIPORTA / FECHAPORTAS



**449**

BUZONES / BOÎTES AUX LETTRES / LETTER BOXES  
CASSETTE POSTALI / CAIXAS DE CORREIO



**439**

CERRAJERÍA / SERRURERIE / LOCKSMITHING  
SERRATURA / SERRALHARIA



**450**

GLOSARIO / GLASSAIRE / GLOSSARY  
GLOSSARIO / GLOSSÁRIO



**441**

CANDADOS / CADENAS / PADLOCKS  
LUCCHETTI / CADEADOS





CILINDRO DE SEGURIDAD PERFIL EUROPEO / CYLINDRE DE SÉCURITÉ PROFIL EUROPÉEN / EUROPEAN SECURITY PROFILE CYLINDER  
 CILINDRO DI SICUREZZA, PROFILO EUROPEO / CILINDRO DE SEGURANÇA PERFIL EUROPEU

**S-3101**

**6 PITONES**

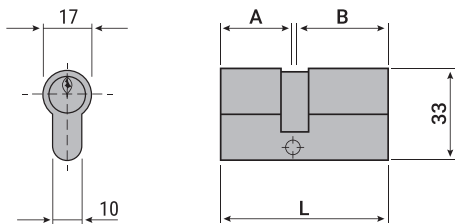

ES Características técnicas: Fabricado en acero y latón. Saliente en acero aglutinado autolubrificante. Muelles en bronce fosforoso. 6 pitones de latón. Compatible con protección antitaladro. Tornillo de fijación incluido. 5 llaves. Color latón y níquel. EN 1303:2005. Key Related Security: grado 4. Leva larga.

FR Caractéristiques techniques: Fabriqué en acier et laiton. Ressorts en bronze phosphoreux. Rainure en acier agglutiné autolubrifiant. Compatible avec protection anti perforation. Vis de fixation incluse. 5 clés. Couleur laiton et nickel. EN 1303:2005. Niveau de Sécurité: degré 4. Came longue.

EN Technical features: brass and steel body pins in brass. Steel self-lubricating agglutinate outgoing antidrilling protection compatible fixing screw included. 5 keys. Nickel and brass color. EN 1303:2005. Key related security: grade 4. Long cam.

IT Caratteristiche tecniche: Realizzato in acciaio e ottone. Molle pistoncini in bronzo fosforoso. Uscita in acciaio legato autolubrificato. Compatibile con protezione contro la foratura. Vite di fissaggio inclusa. 5 chiavi. Color ottone e nichel. EN 1303:2005. Classificazione sicurezza: grado 4. Chiave lunga.

PT Características técnicas: Fabricado em aço e latão. Molas em bronze fosforoso. Saliente em aço aglutinado autolubrificante. Compatível com proteção antiberbequim parafuso de fixação incluído. 5 chaves. Cor latão e níquel. EN 1303:2005. Key Related security: grado 4. Alavanca larga.

Ref	🔑	A	B	↔	🔒	📦	🔗
<b>3101 3030</b>	Latón / Laiton / Brass / Ottone / Latao	30 mm	30 mm	60 mm	1	50	<b>18,65</b>
<b>3101 3040</b>	Latón / Laiton / Brass / Ottone / Latao	30 mm	40 mm	70 mm	1	50	<b>20,20</b>
<b>3101 3535</b>	Latón / Laiton / Brass / Ottone / Latao	35 mm	35 mm	70 mm	1	50	<b>20,25</b>
<b>3101 3545</b>	Latón / Laiton / Brass / Ottone / Latao	35 mm	45 mm	80 mm	1	50	<b>21,84</b>
<b>3101 4040</b>	Latón / Laiton / Brass / Ottone / Latao	40 mm	40 mm	80 mm	1	50	<b>21,85</b>
<b>3101 4545</b>	Latón / Laiton / Brass / Ottone / Latao	45 mm	45 mm	90 mm	1	50	<b>23,88</b>
<b>3101 3030N</b>	Níquel / Nickel / Niquel / Nichel / Níquel	30 mm	30 mm	60 mm	1	50	<b>20,25</b>
<b>3101 3040N</b>	Níquel / Nickel / Niquel / Nichel / Níquel	30 mm	40 mm	70 mm	1	50	<b>23,15</b>
<b>3101 3535N</b>	Níquel / Nickel / Niquel / Nichel / Níquel	35 mm	35 mm	70 mm	1	50	<b>21,85</b>
<b>3101 3545N</b>	Níquel / Nickel / Niquel / Nichel / Níquel	35 mm	45 mm	80 mm	1	50	<b>24,90</b>
<b>3101 4040N</b>	Níquel / Nickel / Niquel / Nichel / Níquel	40 mm	40 mm	80 mm	1	50	<b>24,90</b>
<b>3101 4545N</b>	Níquel / Nickel / Niquel / Nichel / Níquel	45 mm	45 mm	90 mm	1	50	<b>27,08</b>

**6 PITONES**

LLAVES IGUALES / CLES IDENTIQUES / SAME KEYS / MEDESIMA CHIAVE / CHAVES IGUAIS

Ref	🔑	A	B	↔	🔒	📦	🔗
<b>3101 3030.AAA</b>	Latón / Laiton / Brass / Ottone / Latao	30 mm	30 mm	60 mm	1	50	<b>20,53</b>
<b>3101 3040.AAA</b>	Latón / Laiton / Brass / Ottone / Latao	30 mm	40 mm	70 mm	1	50	<b>22,28</b>
<b>3101 3535.AAA</b>	Latón / Laiton / Brass / Ottone / Latao	35 mm	35 mm	70 mm	1	50	<b>22,28</b>
<b>3101 3545.AAA</b>	Latón / Laiton / Brass / Ottone / Latao	35 mm	45 mm	80 mm	1	50	<b>24,02</b>
<b>3101 4040.AAA</b>	Latón / Laiton / Brass / Ottone / Latao	40 mm	40 mm	80 mm	1	50	<b>24,02</b>
<b>3101 4545.AAA</b>	Latón / Laiton / Brass / Ottone / Latao	45 mm	45 mm	90 mm	1	50	<b>26,21</b>
<b>3101 3030N.AAA</b>	Níquel / Nickel / Niquel / Nichel / Níquel	30 mm	30 mm	60 mm	1	50	<b>22,70</b>
<b>3101 3040N.AAA</b>	Níquel / Nickel / Niquel / Nichel / Níquel	30 mm	40 mm	70 mm	1	50	<b>24,02</b>
<b>3101 3535N.AAA</b>	Níquel / Nickel / Niquel / Nichel / Níquel	35 mm	35 mm	70 mm	1	50	<b>24,02</b>
<b>3101 3545N.AAA</b>	Níquel / Nickel / Niquel / Nichel / Níquel	35 mm	45 mm	80 mm	1	50	<b>25,77</b>
<b>3101 4040N.AAA</b>	Níquel / Nickel / Niquel / Nichel / Níquel	40 mm	40 mm	80 mm	1	50	<b>25,77</b>
<b>3101 4545N.AAA</b>	Níquel / Nickel / Niquel / Nichel / Níquel	45 mm	45 mm	90 mm	1	50	<b>27,96</b>





CILINDRO DE SEGURIDAD CON LLAVE NORMAL Y LEVA LARGA, PERFIL EUROPEO / CYLINDRE EUROPÉEN DE SÉCURITÉ AVEC UN CLÉ E PANNETON LONG  
SECURITY EURO CYLINDER WITH KEY AND LONG CAM / SERRATURA DI CILINDRO EURO DI SICUREZZA CON CHIAVE E CAMMA LUNGA  
CILINDRO DE SEGURANÇA CHAVE NORMAL LEVA LARGA PERFIL EUROPEU

S-3111

EN1303:2005

6 PITONES



LLAVE 19D

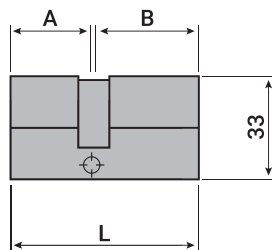

Llaves normal

Ref		A	B	↔	📦	🔑
3111 3030	Latón / Laiton / Brass / Ottone / Latao	30 mm	30 mm	60 mm	1	18,65
3111 3535	Latón / Laiton / Brass / Ottone / Latao	35 mm	35 mm	70 mm	1	20,25
3111 3030N	Níquel / Nickel / Niquel / Nichel / Níquel	30 mm	30 mm	60 mm	1	20,25
3111 3535N	Níquel / Nickel / Niquel / Nichel / Níquel	35 mm	35 mm	70 mm	1	21,85

Llaves iguales / Cles identiques / Same keys / medesima chiave / Chaves iguais

Ref		A	B	↔	📦	🔑
3111 3030.AAA	Latón / Laiton / Brass / Ottone / Latao	30 mm	30 mm	60 mm	1	50 20,53
3111 3535.AAA	Latón / Laiton / Brass / Ottone / Latao	35 mm	35 mm	70 mm	1	50 22,28
3111 3030N.AAA	Níquel / Nickel / Niquel / Nichel / Níquel	30 mm	30 mm	60 mm	1	50 22,28
3111 3535N.AAA	Níquel / Nickel / Niquel / Nichel / Níquel	35 mm	35 mm	70 mm	1	50 24,02

ES Características técnicas: Fabricado en acero y latón. Saliente en acero aglutinado autolubrificante. Muelles en bronce fosforoso. 5 pitones de latón. Compatible con protección antitaladro. Tornillo de fijación incluido. 5 llaves. Color latón y níquel. EN 1303:2005. Key Related Security: grado 4. Leva larga.

FR Caractéristiques techniques: Fabriqué en acier et laiton. Ressorts en bronze phosphoreux. Rainure en acier agglutiné autolubrifiant. Compatible avec protection anti perforation. Vis de fixation incluse. 5 clés. Couleur laiton et nickel. EN 1303:2005. Niveau de Sécurité: degré 4. Came longue.

EN Technical features: brass and steel body pins in brass. Steel self-lubricating agglutinate outgoing antidrilling protection compatible fixing screw included. 5 keys. Niquel and brass color. EN 1303:2005. Key related security: grade 4. Long cam.

IT Caratteristiche tecniche: Realizzato in acciaio e ottone. Molle pistoncini in bronzo fosforoso. Uscita in acciaio legato autolubrificato. Compatibile con protezione contro la foratura. Vite di fissaggio inclusa. 5 chiavi. Color ottone e nichel. EN 1303:2005 Classificazione sicurezza: grado 4. Chiave lunga.

PT Características técnicas: Fabricado em aço e latao. Molas em bronze fosforoso. Saliente em aço aglutinado autolubrificante. Compatível com proteção antiberbequim parafuso de fixação incluido. 5 chaves. Cor latao e níquel. EN 1303:2005. Key Related security: grado 4. Alavanca larga.

CILINDRO DE SEGURIDAD PERFIL EUROPEO DOBLE EMBRAGUE / CYLINDRE DOUBLE EMBRAYAGE DE SECURITE CLAPET LONG-LAITON  
SECURITY CYLINDER DOUBLE CLUTCH LONG CAM-BRASS / CILINDRO SICUREZZA DOPPIA FRIZIONE LEVA LUNGA-OTTONE  
CILINDRO SEG. D. EMBREAGEM C. LONGA-BRONZE

S-3108

LEVA LARGA

6 PITONES

DOBLE EMBRAGUE

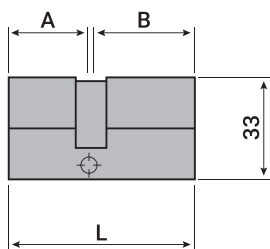
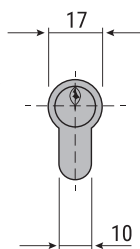

ES Cilindro de seguridad doble embrague con leva larga en latón y Níquel. Se suministra con 5 llaves. Estos cilindros o bombines de doble embrague permiten tener insertada una llave por cada lado y que ambas funcionen perfectamente de manera que es posible la apertura desde ambos lados con las llaves insertadas.

FR Cylindre de sécurité double embrayage avec clapet long en laiton et nickel. Fourni avec 5 clés. Ces cylindres ou serrures de double embrayage permettent d'avoir une clé insérée de chaque côté et que toutes les deux fonctionnent parfaitement de sorte que l'ouverture soit possible à partir des deux côtés avec les clés introduites.

EN Security cylinder with double clutch mechanism and long cam available in brass or nickel finishes. It is supplied with 5 keys. These cylinders with double clutch function allow the insertion of a key on each side, being possible to open from both sides even if the keys are inserted.

IT Cilindro di sicurezza a doppia frizione a nottolino lungo in ottone e nichel. Fornito con 5 chiavi. Questi cilindri a doppia membrana permettono di aprire la porta su ciascun lato anche se la chiave è già inserita nel foro opposto.

PT Cilindro de segurança, dupla embreagem com came longa em cobre e níquel. É fornecido com 5 chaves. Estes cilindros ou mecanismos de dupla embreagem permitem ter uma chave inserida em cada lado e que ambas funcionem perfeitamente de modo que seja possível a abertura de ambos os lados com as chaves inseridas.

Ref		A	B	↔	📦	🔑
3108 3040	Latón / Laiton / Brass / Ottone / Latao	30 mm	40 mm	70 mm	1	50 23,59
3108 3535	Latón / Laiton / Brass / Ottone / Latao	35 mm	35 mm	70 mm	1	50 23,59
3108 3545	Latón / Laiton / Brass / Ottone / Latao	35 mm	45 mm	80 mm	1	50 25,33
3108 4040	Latón / Laiton / Brass / Ottone / Latao	40 mm	40 mm	80 mm	1	50 25,33
3108 4545	Latón / Laiton / Brass / Ottone / Latao	45 mm	45 mm	90 mm	1	50 27,52
3108 3040N	Níquel / Nickel / Niquel / Nichel / Níquel	30 mm	40 mm	70 mm	1	50 25,33
3108 3535N	Níquel / Nickel / Niquel / Nichel / Níquel	35 mm	35 mm	70 mm	1	50 25,33
3108 3545N	Níquel / Nickel / Niquel / Nichel / Níquel	35 mm	45 mm	80 mm	1	50 27,08
3108 4040N	Níquel / Nickel / Niquel / Nichel / Níquel	40 mm	40 mm	80 mm	1	50 27,08
3108 4545N	Níquel / Nickel / Niquel / Nichel / Níquel	45 mm	45 mm	90 mm	1	50 29,27



CILINDRO SEGURIDAD ANTIBUMPING LEVA LARGA-LATÓN/NÍQUEL / CYLINDRE SECURITE ANTIBUMPING CLAPET LONG-LAITON/NICKEL  
 SECURITY CYLINDER ANTI-BUMPING LONG CAM-BRASS/NIQUEL / CILINDRO SICUREZZA ANTIURTO LEVA LUNGA-OTTONE/NICHEL  
 CILINDRO SEGURANÇA ANTIBUMPING CAME LONGA-LATÃO/NÍQUEL

EN1303:2005

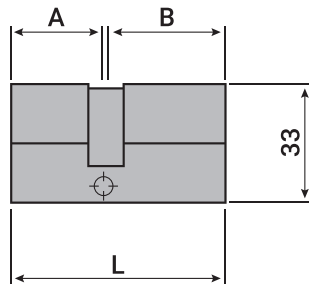

10 PITONES  
 ANTIBUMPING



Incluye tarjeta identificativa para copias de llaves.  
 Inclut la carte d'identification pour copies de clés.  
 Includes an identification card for key duplication.  
 Include targhetta identificativa per la copia delle chiavi.  
 Inclui cartão de identificação para cópias de chaves.

ES Características Técnicas: Fabricada en acero y latón. Saliente en acero aglutinado autolubrificante, muelles de bronce fosforoso, sistema de 9 pitones 6 activos y 4 pasivos. Cuerpo en latón con alma compuesta por láminas de acero templado. Rotor en latón con pitones y contrapitones antiganzúa de bronce y latón. Compuesto de 5 llaves planas reversibles de cuello largo y tarjeta con código de identificación. Certificado EN1303:2005 Grado 6 durabilidad, Grado 3 seguridad. Leva larga.

FR Caractéristiques Techniques: Fabriquée en acier et laiton. Gache en acier agglutiné autolubrifiant, ressort en bronze phosphoreux, système de 9 points 6 actifs et 4 passifs. Corps en laiton avec noyau composé de lames en acier trempé. Rotor en laiton avec points et contreponts antipick en bronze et laiton. Composé de 5 clés plates réversibles à cols longs et carte avec code d'identification. Certifié EN1303:2005 grade 6 durabilité, Grade 3 sécurité. Clapet long.

EN Technical features: Made of steel and brass. Self-lubricating steel projection, phosphor bronze springs, a system composed of 9 pins: 6 active and 4 passive. Brass body and core made of tempered steel sheets. Brass keyway with pins and anti-picklock bronze and brass driver pins. It is supplied with 5 flat and reversible keys with long blade and a card with an identification code. Certificate EN 1303:2005. Durability: Grade 6. Security: Grade 3. Long cam.

IT Caratteristiche Tecniche: Prodotto in acciaio e ottone. Uscita in acciaio autolubrificante, molle in bronzo fosforoso, sistema a 9 pistoni di cui 6 attivi e 4 passivi. Corpo in ottone con anima composta in acciaio temprato. Rotore in ottone con pistoni e contropistoni antigrimaldello in bronzo e ottone. Composto da 5 chiavi piatte reversibili a collo lungo e con codice identificativo (targhetta). Certificato EN1303:2005 - Grado 6 durabilità, Grado 3 sicurezza. Chiave lunga.

PT Características técnicas: Fabricada em aço e latão. Saliência em aço aglutinado auto-lubrificante, molas de bronze de fósforo, sistema de 9 pítões 6 ativos e 4 passivos. Corpo de bronze com alma composta de camadas de aço endurecido. Rotor em latão com pítões e contra pítões anti gazua de bronze e latão. Composto por 5 chaves reversíveis planas de pescoços longos e cartão com código de identificação. Certificado: EN1303:2005 Grau 6 durabilidade, Grau 3 segurança. Came longa.

Ref		A	B	↔	📦	📦
3109 3030	Latón / Laiton / Brass / Ottone / Latao	30 mm	30 mm	60 mm	1	43,68
3109 3040	Latón / Laiton / Brass / Ottone / Latao	30 mm	40 mm	70 mm	1	48,05
3109 3535	Latón / Laiton / Brass / Ottone / Latao	35 mm	35 mm	70 mm	1	48,05
3109 3545	Latón / Laiton / Brass / Ottone / Latao	35 mm	45 mm	80 mm	1	52,42
3109 4040	Latón / Laiton / Brass / Ottone / Latao	40 mm	40 mm	80 mm	1	52,42
3109 4545	Latón / Laiton / Brass / Ottone / Latao	45 mm	45 mm	90 mm	1	53,94



Ref		A	B	↔	📦	📦
3109 3030N	Níquel / Nickel / Níquel / Nickel / Níquel	30 mm	30 mm	60 mm	1	45,86
3109 3040N	Níquel / Nickel / Níquel / Nickel / Níquel	30 mm	40 mm	70 mm	1	50,23
3109 3535N	Níquel / Nickel / Níquel / Nickel / Níquel	35 mm	35 mm	70 mm	1	50,23
3109 3545N	Níquel / Nickel / Níquel / Nickel / Níquel	35 mm	45 mm	80 mm	1	54,60
3109 4040N	Níquel / Nickel / Níquel / Nickel / Níquel	40 mm	40 mm	80 mm	1	54,60
3109 4545N	Níquel / Nickel / Níquel / Nickel / Níquel	45 mm	45 mm	90 mm	1	56,13



CILINDROS DE PERFIL EUROPEO LEVA CORTA / CYLINDRE DE PROFIL EUROPÉEN CAME COURTE / EUROPEAN PROFILE CYLINDER SHORT CAM  
 CILINDRO PROFILO EUROPEO CHIAVE CORTA / CILINDRO DE PERFIL EUROPEU ALAVANCA CORTA

S-3103

5 PITONES

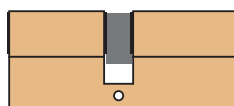

LEVA CORTA  
SHORT CAM

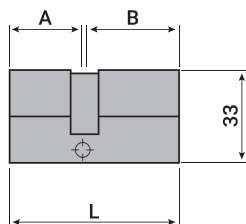

ES Características técnicas: Fabricado en acero y latón. Saliente en acero aglutinado autolubrificante. Muelles de bronce fosforoso. 5 pitones de latón. Tornillo de fijación incluido. 3 llaves. Color latón y níquel. EN 1303:2005. Grado de seguridad: grado 6. Leva corta.

FR Caractéristiques Techniques: Fabriqué en acier et laiton. Gache en acier agglutiné autolubrifiant. Ressort en bronze phosphoreux. 5 points en laiton. Vis de fixation incluse. 3 clés. Couleur laiton et nickel. Certifié EN1303:2005. Grade sécurité: grade 6. Clapet courte.

EN Technical features: Made of steel and brass. Self-lubricating steel projection. Phosphor bronze springs. 5 brass pins. Fixing screw included. 3 keys. Available in brass and nickel colours. Certificate EN 1303:2005. Key Related Security: Grade 6. Short cam.

IT Caratteristiche Tecniche: Prodotto in acciaio e ottone. Uscita in acciaio autolubrificante. Molle in bronzo fosforoso. 9 pistoni in ottone. Vite di fissaggio inclusa. 3 chiavi. color ottone e nichel. Certificato EN1303:2005. Grado sicurezza: grado 6. Chiave corta.

PT Características técnicas: Fabricada em aço e latão. Saliência em aço aglutinado autolubrificante. Molas de bronze de fósforo. 9 pitons em latão. Parafuso de fixação incluído. 3 chaves. Cor latão e níquel. Certificado EN1303:2005. Grau segurança: grado 3. Came corta.

Leva Corta / Came longue / Long cam / Chiave lunga / Alavanca larga

Ref		A	B	↔	🏠	📦	📦
3103 3030	Latón / Laiton / Brass / Ottone / Latao	30 mm	30 mm	60 mm	1	50	10,55
3103 3040	Latón / Laiton / Brass / Ottone / Latao	30 mm	40 mm	70 mm	1	50	12,23
3103 3535	Latón / Laiton / Brass / Ottone / Latao	35 mm	35 mm	70 mm	1	50	12,23
3103 3545	Latón / Laiton / Brass / Ottone / Latao	35 mm	45 mm	80 mm	1	50	14,30
3103 4040	Latón / Laiton / Brass / Ottone / Latao	40 mm	40 mm	80 mm	1	50	14,40
3103 4050	Latón / Laiton / Brass / Ottone / Latao	40 mm	50 mm	90 mm	1	50	14,14
3103 4545	Latón / Laiton / Brass / Ottone / Latao	45 mm	45 mm	90 mm	1	50	14,30
3103 3030N	Níquel / Nickel / Nickel / Nichel / Níquel	30 mm	30 mm	60 mm	1	50	12,20
3103 3040N	Níquel / Nickel / Nickel / Nichel / Níquel	30 mm	40 mm	70 mm	1	50	13,98
3103 3535N	Níquel / Nickel / Nickel / Nichel / Níquel	35 mm	35 mm	70 mm	1	50	13,98
3103 3545N	Níquel / Nickel / Nickel / Nichel / Níquel	35 mm	45 mm	80 mm	1	50	15,15
3103 4040N	Níquel / Nickel / Nickel / Nichel / Níquel	40 mm	40 mm	80 mm	1	50	15,20
3103 4050N	Níquel / Nickel / Nickel / Nichel / Níquel	40 mm	50 mm	90 mm	1	50	15,96
3103 4545N	Níquel / Nickel / Nickel / Nichel / Níquel	45 mm	45 mm	90 mm	1	50	15,96

Leva corta, llaves iguales / Came courte, clés identiques / Short cam, identical keys  
 Chiave corta, medesima chiave / Alavanca corta, chaves iguais

Ref		A	B	↔	🏠	📦	📦
3103 3030.AAA	Latón / Laiton / Brass / Ottone / Latao	30 mm	30 mm	60 mm	1	1	11,80
3103 3040.AAA	Latón / Laiton / Brass / Ottone / Latao	30 mm	40 mm	70 mm	1	1	13,10
3103 3535.AAA	Latón / Laiton / Brass / Ottone / Latao	35 mm	35 mm	70 mm	1	1	13,10
3103 3545.AAA	Latón / Laiton / Brass / Ottone / Latao	35 mm	45 mm	80 mm	1	1	14,14
3103 4040.AAA	Latón / Laiton / Brass / Ottone / Latao	45 mm	40 mm	80 mm	1	1	14,14
3103 4050.AAA	Latón / Laiton / Brass / Ottone / Latao	40 mm	50 mm	90 mm	1	1	15,72
3103 4545.AAA	Latón / Laiton / Brass / Ottone / Latao	45 mm	45 mm	90 mm	1	1	15,72
3103 3030N.AAA	Níquel / Nickel / Nickel / Nichel / Níquel	30 mm	30 mm	60 mm	1	1	13,04
3103 3040N.AAA	Níquel / Nickel / Nickel / Nichel / Níquel	30 mm	40 mm	70 mm	1	1	14,46
3103 3535N.AAA	Níquel / Nickel / Nickel / Nichel / Níquel	35 mm	35 mm	70 mm	1	1	14,46
3103 3545N.AAA	Níquel / Nickel / Nickel / Nichel / Níquel	35 mm	45 mm	80 mm	1	1	15,96
3103 4040N.AAA	Níquel / Nickel / Nickel / Nichel / Níquel	45 mm	40 mm	80 mm	1	1	15,96
3103 4050N.AAA	Níquel / Nickel / Nickel / Nichel / Níquel	40 mm	50 mm	90 mm	1	1	17,47
3103 4545N.AAA	Níquel / Nickel / Nickel / Nichel / Níquel	45 mm	45 mm	90 mm	1	1	17,47



CILINDROS DE PERFIL EUROPEO LEVA LARGA / CYLINDRE DE PROFIL EUROPÉEN CAME LONGUE / EUROPEAN PROFILE CYLINDER LONG CAM  
 CILINDRO PROFILO EUROPEO CHIAVE LUNGA / CILINDRO DE PERFIL EUROPEU ALAVANCA LARGA

S-3104

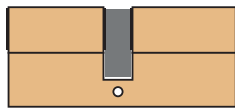

LEVA LARGA  
LONG CAM

S-3105

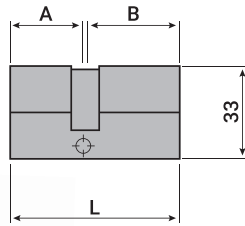

ES Características técnicas: Fabricado en acero y latón. Saliente en acero aglutinado autolubrificante. Muelles de bronce fosforoso. 5 pitones de latón. Tornillo de fijación incluido. 3 llaves. Color latón y níquel. EN 1303:2005. Grado de seguridad: grado 6. Leva larga.

FR Caractéristiques Techniques: Fabriquée en acier et laiton. Gache en acier agglutiné autolubrifiant. Ressort en bronze phosphoreux. 5 points en laiton. Vis de fixation incluse. 3 clés. Couleur laiton et nickel. Certifié EN1303:2005. Grade sécurité: grade 6. Clapet long.

EN Technical features: Made of steel and brass. Self-lubricating steel projection. Phosphor bronze springs. 5 brass pins. Fixing screw included. 3 keys. Available in brass and nickel colours. Certificate EN 1303:2005. Key Related Security: Grade 6. Long cam.

IT Caratteristiche Tecniche: Prodotto in acciaio e ottone. Uscita in acciaio autolubrificante. Molle in bronzo fosforoso. 9 pistoncini in ottone. Vite di fissaggio inclusa. 3 chiavi. color ottone e nichel. Certificato EN1303:2005. Grado sicurezza: grado 6. Chiave lunga.

PT Características técnicas: Fabricada em aço e latão. Saliência em aço aglutinado autolubrificante. Molas de bronze de fósforo. 9 pitões em latão. Parafuso de fixação incluído. 3 chaves. Cor latão e níquel. Certificado EN1303:2005. Grau segurança: grado 3. Came longa.

Leva Larga / Came longue / Long cam / Chiave lunga / Alavanca larga

Ref		A	B	↔	🔑	🔒	📦
3104 3030	Latón / Laiton / Brass / Ottone / Latao	30 mm	30 mm	60 mm	1	50	10,55
3104 3040	Latón / Laiton / Brass / Ottone / Latao	30 mm	40 mm	70 mm	1	50	13,45
3104 3060	Latón / Laiton / Brass / Ottone / Latao	30 mm	60 mm	90 mm	1	50	14,85
3104 3535	Latón / Laiton / Brass / Ottone / Latao	35 mm	35 mm	70 mm	1	50	11,80
3104 3545	Latón / Laiton / Brass / Ottone / Latao	35 mm	45 mm	80 mm	1	50	13,98
3104 4040	Latón / Laiton / Brass / Ottone / Latao	40 mm	40 mm	80 mm	1	50	13,98
3104 4050	Latón / Laiton / Brass / Ottone / Latao	40 mm	50 mm	90 mm	1	50	14,85
3104 4545	Latón / Laiton / Brass / Ottone / Latao	45 mm	45 mm	90 mm	1	50	14,85
3104 3030N	Níquel / Nickel / Nickel / Nichel / Níquel	30 mm	30 mm	60 mm	1	50	12,20
3104 3040N	Níquel / Nickel / Nickel / Nichel / Níquel	30 mm	40 mm	70 mm	1	50	13,98
3104 3535N	Níquel / Nickel / Nickel / Nichel / Níquel	35 mm	35 mm	70 mm	1	50	14,30
3104 3545N	Níquel / Nickel / Nickel / Nichel / Níquel	35 mm	45 mm	80 mm	1	50	15,72
3104 4040N	Níquel / Nickel / Nickel / Nichel / Níquel	40 mm	40 mm	80 mm	1	50	15,72
3104 4050N	Níquel / Nickel / Nickel / Nichel / Níquel	40 mm	50 mm	90 mm	1	50	16,60
3104 4545N	Níquel / Nickel / Nickel / Nichel / Níquel	45 mm	45 mm	90 mm	1	50	16,60

Leva larga, llaves iguales / Came longue, clés identiques / Long cam, identical keys  
 Chiave lunga, medesima chiave / Alavanca larga, chaves iguais

Ref		A	B	↔	🔑	🔒	📦
3105 3030.AAA	Latón / Laiton / Brass / Ottone / Latao	30 mm	30 mm	60 mm	1	11,40	
3105 3030.BBB	Latón / Laiton / Brass / Ottone / Latao	30 mm	30 mm	60 mm	1	11,40	
3105 3030.CCC	Latón / Laiton / Brass / Ottone / Latao	30 mm	30 mm	60 mm	1	11,40	
3105 3040.AAA	Latón / Laiton / Brass / Ottone / Latao	30 mm	40 mm	70 mm	1	12,65	
3105 3040.BBB	Latón / Laiton / Brass / Ottone / Latao	30 mm	40 mm	70 mm	1	12,65	
3105 3040.CCC	Latón / Laiton / Brass / Ottone / Latao	30 mm	40 mm	70 mm	1	12,65	
3105 3535.AAA	Latón / Laiton / Brass / Ottone / Latao	35 mm	35 mm	70 mm	1	12,65	
3105 3535.BBB	Latón / Laiton / Brass / Ottone / Latao	35 mm	35 mm	70 mm	1	12,65	
3105 3535.CCC	Latón / Laiton / Brass / Ottone / Latao	35 mm	35 mm	70 mm	1	12,65	
3105 3545.AAA	Latón / Laiton / Brass / Ottone / Latao	35 mm	45 mm	80 mm	1	14,77	
3105 4040.AAA	Latón / Laiton / Brass / Ottone / Latao	45 mm	40 mm	80 mm	1	15,15	
3105 4050.AAA	Latón / Laiton / Brass / Ottone / Latao	40 mm	50 mm	90 mm	1	15,39	
3105 3030N.AAA	Níquel / Nickel / Nickel / Nichel / Níquel	30 mm	30 mm	60 mm	1	13,04	
3105 3030N.BBB	Níquel / Nickel / Nickel / Nichel / Níquel	30 mm	30 mm	60 mm	1	13,04	
3105 3030N.CCC	Níquel / Nickel / Nickel / Nichel / Níquel	30 mm	30 mm	60 mm	1	12,75	
3105 3040N.AAA	Níquel / Nickel / Nickel / Nichel / Níquel	30 mm	40 mm	70 mm	1	14,85	
3105 3040N.BBB	Níquel / Nickel / Nickel / Nichel / Níquel	30 mm	40 mm	70 mm	1	14,85	
3105 3040N.CCC	Níquel / Nickel / Nickel / Nichel / Níquel	30 mm	40 mm	70 mm	1	14,85	
3105 3535N.AAA	Níquel / Nickel / Nickel / Nichel / Níquel	35 mm	35 mm	70 mm	1	14,28	
3105 3535N.BBB	Níquel / Nickel / Nickel / Nichel / Níquel	35 mm	35 mm	70 mm	1	14,28	
3105 3535N.CCC	Níquel / Nickel / Nickel / Nichel / Níquel	35 mm	35 mm	70 mm	1	14,28	
3105 3545N.AAA	Níquel / Nickel / Nickel / Nichel / Níquel	35 mm	45 mm	80 mm	1	16,22	
3105 4040N.AAA	Níquel / Nickel / Nickel / Nichel / Níquel	45 mm	40 mm	80 mm	1	16,22	
3105 4050N.AAA	Níquel / Nickel / Nickel / Nichel / Níquel	40 mm	50 mm	90 mm	1	17,06	





CILINDRO MEDIO DE PERFIL EUROPEO / CYLINDRE MOYEN DE PROFIL EUROPÉEN / EUROPEAN PROFILE CYLINDER  
 CILINDRO MEDIO, PROFILO EUROPEO / CILINDRO MEDIO DE PERFIL EUROPEU

S-3106

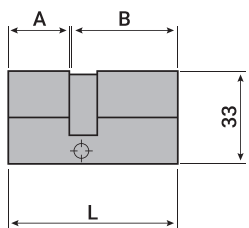

Ref		A	B	↔			
3106 3010	Latón / Laiton / Brass / Ottone / Latao	30 mm	10 mm	40 mm	1	50	<b>10,05</b>
3106 4010	Latón / Laiton / Brass / Ottone / Latao	40 mm	10 mm	50 mm	1	50	<b>11,36</b>

Grupos de llaves iguales / Groupe de clés identiques / Same key sets  
 Gruppi con la medesima chiave / Grupos de chaves iguais

Ref		A	B	↔			
3106 3010.AAA	Latón / Laiton / Brass / Ottone / Latao	30 mm	10 mm	40 mm	1	50	<b>10,92</b>
3106 4010.AAA	Latón / Laiton / Brass / Ottone / Latao	40 mm	10 mm	50 mm	1	50	<b>12,23</b>

ES Características técnicas: Fabricado en acero y latón. Saliente en acero aglutinado autolubrificante. Muelles de bronce fosforoso. 5 pitones de latón. Tornillo de fijación incluido. 3 llaves. Color latón. EN 1303:2005. Key related security: grado 6. Leva larga estándar.

FR Caractéristiques Techniques: Fabriqué en acier et laiton. Rainure en acier agglutiné autolubrifiant. Ressorts en bronze phosphoreux. 5 pistons en laiton. Vis de fixation incluse. 3 clés. Couleur laiton. EN 1303:2005. Niveau de Sécurité : degré 6. Came longueur standard

EN Technical features: Brass and steel body. Steel self-lubricating agglutinate outgoing pins in brass. 5 pins key biting system. Fixing screw included. 3 keys. Brass color. EN 1303:2005. Key related security: grade 6. Standard long cam.

IT Caratteristiche tecniche: Prodotto in acciaio e ottone. Uscita in acciaio legato autolubrificato. Molle pistoncini in bronzo fosforoso. 5 pistoncini in ottone. Vite di fissaggio inclusa. 3 chiavi. Color ottone. EN 1303:2005. Classificazione sicurezza: grado 6. Chiave lunga standard.

PT Características técnicas: Fabricado en aço e latao. Saliente em aço aglutinado autolubrificante. Molas de bronze fosforoso. 5 pontos de latao. Parafuso de fixação incluido. 3 chaves. Cor latao e Níquel. EN 1303:2005. Key Related Security: grado 6. Alavanca longa estandar.

CILINDRO OVAL DE PERFIL EUROPEO / CYLINDRE OVALE PROFIL EUROPÉEN / OVAL CYLINDER  
 CILINDRO OVALE, PROFILO EUROPEO / CILINDRO OVAL DE PERFIL EUROPEU

S-3107

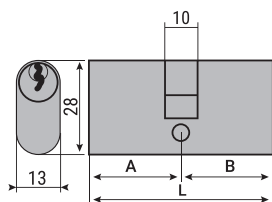

Ref		A	B	↔			
3107 2727	Latón / Laiton / Brass / Ottone / Latao	27 mm	27 mm	54 mm	1	50	<b>12,05</b>
3107 3040	Latón / Laiton / Brass / Ottone / Latao	30 mm	40 mm	70 mm	1	50	<b>15,29</b>

Grupos de llaves iguales / Groupe de clés identiques / Same key sets  
 Gruppi con la medesima chiave / Grupos de chaves iguais

Ref		A	B	↔			
3107 2727.AAA	Latón / Laiton / Brass / Ottone / Latao	27 mm	27 mm	54 mm	1	50	<b>12,67</b>
3107 3040.AAA	Latón / Laiton / Brass / Ottone / Latao	30 mm	40 mm	70 mm	1	50	<b>16,38</b>

ES Características técnicas: Fabricado en acero y latón. Saliente en acero aglutinado autolubrificante. Muelles de bronce fosforoso. Tornillo de fijación incluido. 3 llaves. Color latón. Leva larga estándar.

FR Caractéristiques techniques: Fabriqué en acier et laiton. Rainure en acier agglutiné. Ressorts en bronze phosphoreux. Vis de fixation incluse. 3 clés. Couleur laiton. Came longueur standard.

EN Technical features: Brass and steel body. Steel self-lubricating agglutinate outgoing. Pins in brass. Fixing screw included. 3 keys. Standard long cam.

IT Caratteristiche tecniche: Prodotto in acciaio e ottone. Uscita in acciaio legato. Molle pistoncini in bronzo fosforoso. Vite di fissaggio inclusa. 3 chiavi. Color ottone. Chiave lunga standard.

PT Características técnicas: Fabricado em aço e latao. Saliente em aço aglutinado autolubrificante. Molas de bronze fosforoso. Parafuso de fixação incluido. 3 chaves. Cor latao. Alavanca longa estandar.

CILINDRO CON POMO PERFIL EUROPEO / CYLINDRE AVEC POMMEAU PROFIL EUROPÉEN / EUROPEAN PROFILE CYLINDER WITH KNOB  
 CILINDRO CON POMOLO, PROFILO EUROPEO / CILINDRO COM BOTAO PERFIL EUROPEU

S-3102

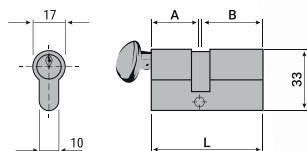

Ref		A	B	↔			
3102 3030	Latón / Laiton / Brass / Ottone / Latao	30 mm	30 mm	60 mm	1	50	<b>20,16</b>
3102 3040	Latón / Laiton / Brass / Ottone / Latao	30 mm	40 mm	70 mm	1	50	<b>22,28</b>

Grupos de llaves iguales / Groupe de clés identiques / Same key sets  
 Gruppi con la medesima chiave / Grupos de chaves iguais

Ref		A	B	↔			
3102 3030.AAA	Latón / Laiton / Brass / Ottone / Latao	30 mm	30 mm	60 mm	1	50	<b>21,84</b>
3102 3040.AAA	Latón / Laiton / Brass / Ottone / Latao	30 mm	40 mm	70 mm	1	50	<b>23,15</b>

ES Características técnicas: Pomo de latón. Fabricado en acero y latón. Saliente en acero aglutinado autolubrificante. Muelles de bronce fosforoso. 5 pitones de latón. Compatible con protección antitaladro. Tornillo de fijación incluido. 3 llaves. Color latón. EN 1303:2005. Key Related Security: grado 6. Leva larga.

FR Caractéristiques techniques: Pommeau en laiton. Fabriqué en acier et laiton. Rainure en acier agglutiné autolubrifiant. Ressorts en bronze phosphoreux. 5 pistons en laiton. Compatible avec protection anti perforation. Vis de fixation incluse. 3 clés. Couleur laiton. EN 1303:2005. Niveau de Sécurité : degré 6. Came longue

EN Technical features: Brass knob. Brass and steel body. Steel self-lubricating agglutinate outgoing. Pins in brass. 5 pins key biting system. Antidrilling protection compatible. Fixing screw included. 3 keys. Brass color. EN 1303:2005. Key related security: grade 6 Long cam.

IT Caratteristiche tecniche: Pomolo in ottone. Prodotto in acciaio e ottone. Uscita in acciaio legato autolubrificato. Molle pistoncini in bronzo fosforoso. 5 pistoncini in ottone. Compatible con protezione contro la foratura. Vite di fissaggio inclusa. 3 chiavi. Color ottone. EN 1303:2005. Classificazione sicurezza: grado 6. Camma lunga.

PT Características técnicas: botão de latao. Fabricado em aço e latao. Saliente em aço aglutinado autolubrificante. Molas de bronze fosforoso. 5 pitões de latao. Compatível com proteção antiberbequim. Parafuso de fixação incluido. 3 chaves. Cor latao. EN 1303:2005. Key Related Security: grado 6. Alavanca larga.





CERRADURA EMBUTIR C/ CERRADERO (PUERTAS METAL) / SERRURE AVEC BARILLET (PORTES MÉTAL) / MORTISE CYLINDER LOCK (METAL DOORS)  
SERRATURA INCASSATA CON VANO PORTASERRATURA (PORTE IN METALLO) / FECHADURA EMBUTIR C/ GUARDADOR (PORTAS META)

## S-3120

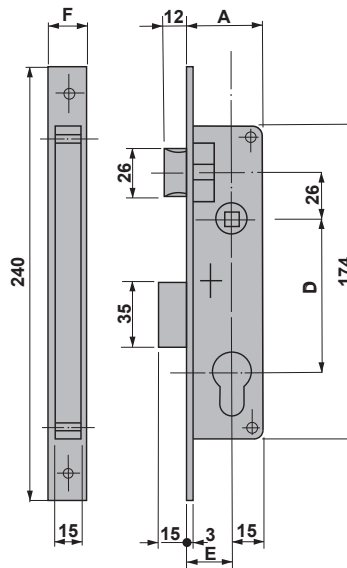

ES Características técnicas: Cuerpo pintado. Frente en acero niquelado. Palanca deslizante niquelada. Picaporte reversible niquelado. Contiene Tornillo de fijación, cerradura y cerradero

FR Caractéristiques techniques: Corps peint. Partie avant en acier nickelé. Levier coulissant nickelé. Verrou réversible nickelé. Vis de fixation inclus. Serrure et barillet.

EN Technical features: painted color. Nickel steel front. Steel slippery lever. Steel reversible latch. Fixing screw included. Latch and striker

IT Caratteristiche tecniche: Corpo dipinto. Fronte in acciaio nichelato. Leva di scorrimento in nichel. Fermo reversibile in nichel. Contiene vite di fissaggio. Serratura e vano portaserratura.

PT Características técnicas: Corpo pintado. Frente em aço niquelado. Alavanca a gancho niquelada. Trinco reversível niquelado. Contem parafuso de fixação. Fechadura e trinco.

Ref		D	E	F			
3120 8520	Níquel / Nickel / Níquel / Nichel / Níquel	85 mm	20 mm	22 mm	1	25	<b>12,23</b>
3120 8525	Níquel / Nickel / Níquel / Nichel / Níquel	85 mm	25 mm	22 mm	1	25	<b>13,10</b>
3120 8530	Níquel / Nickel / Níquel / Nichel / Níquel	85 mm	30 mm	22 mm	1	25	<b>13,10</b>
1984 8523	Níquel / Nickel / Níquel / Nichel / Níquel	85 mm	23 mm	22 mm	1	25	<b>13,10</b>
1984 8528	Níquel / Nickel / Níquel / Nichel / Níquel	85 mm	28 mm	22 mm	1	25	<b>13,10</b>

Leva corta / Short cam

PICAPORTE EMBUTIR (PUERTAS MADERA) / SERRURE (PORTES BOIS) / MORTISE CYLINDER (WOOD DOORS)  
SERRATURA INCASSATA (PORTE IN LEGNO) / FECHADURA EMBUTIR (PORTAS MADEIRA)

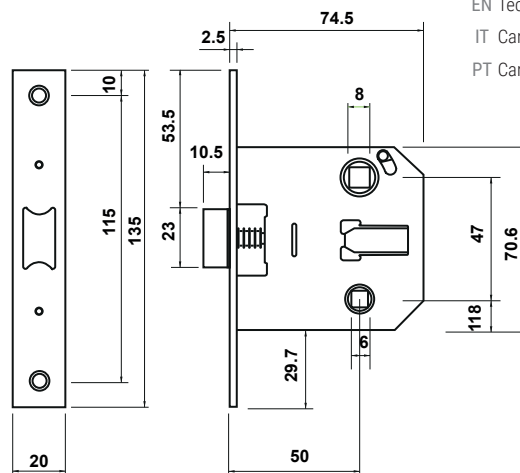

ES Características técnicas: Picaporte reversible niquelado.

FR Caractéristiques techniques: Verrou réversible nickelé.

EN Technical features: Steel slippery lever.

IT Caratteristiche tecniche: Fermo reversibile in nichel.

PT Características técnicas: Trinco reversível niquelado.

Ref		FRENTE	D	E			
8890 5001	Níquel / Nickel / Níquel / Nichel / Níquel	□	47 mm	50 mm	1	5	<b>3,95</b>
8890 5002	Níquel / Nickel / Níquel / Nichel / Níquel	□	47 mm	50 mm	1	10	<b>3,95</b>
8890 5003	Latón / Laiton / Brass / Ottone / Latao	□	47 mm	50 mm	1	5	<b>3,95</b>
8890 5004	Latón / Laiton / Brass / Ottone / Latao	□	47 mm	50 mm	1	10	<b>3,95</b>
8890 5005	Inox	□	47 mm	50 mm	1	5	<b>4,78</b>
8890 5006	Inox	□	47 mm	50 mm	1	10	<b>4,78</b>



CERRADURA EMBUTIR PALANCA D85E38 INOX (LEVA CORTA) / S-3121 SERRURE À ENCASTRER LEVIER D85E38 INOX (CLAPET COURT)  
 S-3121 MORTISE LOCK WITH LEVER D85E38 ST. STEEL (SHORT CAM) / S-3121 SERRATURA DA INFILARE CON LEVA D85E38 INOX (L. CORTA)  
 S-3121 FECHADURA EMBUTIR ALAVANCA D85E38 INOX (C.CURTA)

S-3121

INOX

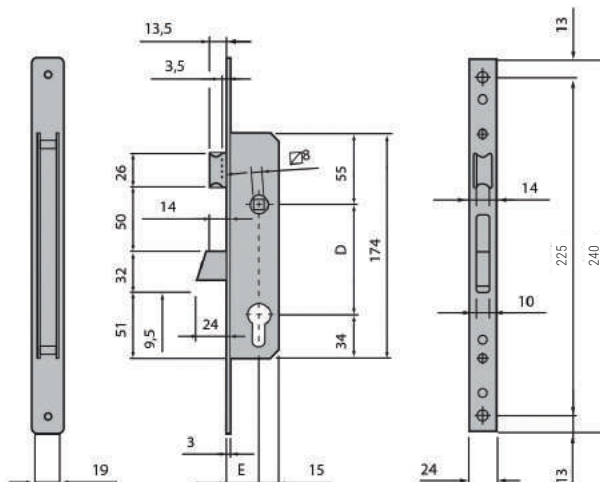

Ref	🔗	FRENTE	D	E	🏠	📦	🔧
3121 8523	Inox	☐	85 mm	23 mm	1	25	25,20
3121 8528	Inox	☐	85 mm	28 mm	1	25	25,20
3121 8533	Inox	☐	85 mm	33 mm	1	25	25,20
3121 8538	Inox	☐	85 mm	38 mm	1	25	25,20

CERRADURA EMBUTIR PALANCA D85E23 NÍQUEL (L.CORTA) / SERRURE À ENCASTRER LEVIER D85E23 NICKEL (CLAPET COURT)  
 MORTISE LOCK WITH LEVER D85E23 NICKEL (SHORT CAM) / SERRATURA DA INFILARE CON LEVA D85E23 NICHEL (L. CORTA)  
 FECHADURA EMBUTIR ALAVANCA D85E23 NÍQUEL (C.CURTA)

S-3121

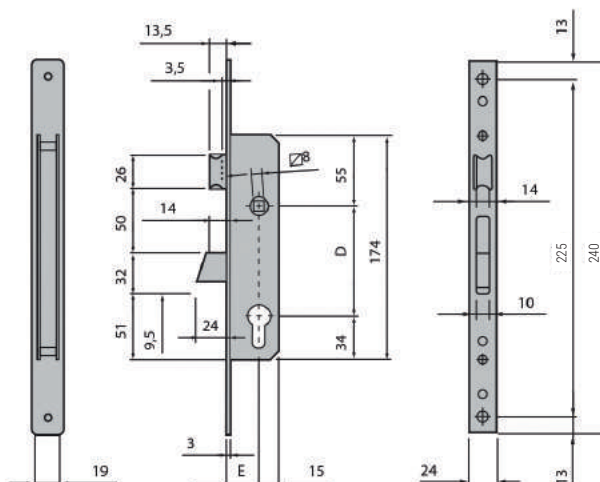

Ref	🔗	FRENTE	D	E	🏠	📦	🔧
3121 8523N	Níquel / Nickel / Níquel / Nichel / Níquel	☐	85 mm	23 mm	1	25	21,16
3121 8528N	Níquel / Nickel / Níquel / Nichel / Níquel	☐	85 mm	28 mm	1	25	21,16
3121 8533N	Níquel / Nickel / Níquel / Nichel / Níquel	☐	85 mm	33 mm	1	25	21,16
3121 8538N	Níquel / Nickel / Níquel / Nichel / Níquel	☐	85 mm	38 mm	1	25	21,16



CERRADURA EMBUTIR GANCHO D85E23 INOX (L.CORTA) / SERRURE À ENCASTRER CROCHET D85E23 INOX (CLAPET COURT)  
MORTISE LOCK WITH HOOK D85E23 ST. STEEL (SHORT CAM) / SERRATURA DA INFILARE CON GANCIO D85E23 INOX (L. CORTA)  
FECHADURA EMBUTIR GANCHO D85E23 INOX (C.CURTA)

S-3122

INOX

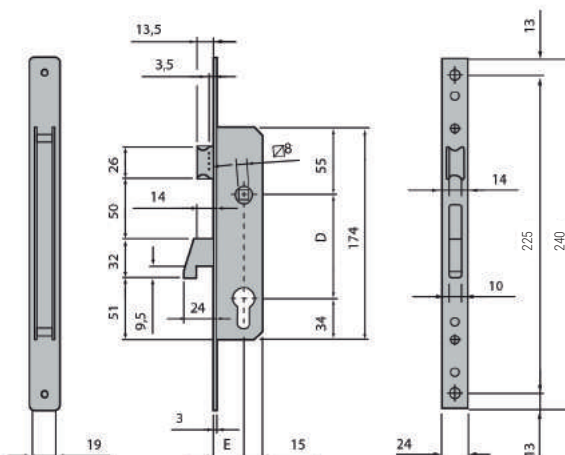

Ref		FRENTE	D	E			
3122 8523	Inox		85 mm	23 mm	1	25	26,21
3122 8528	Inox		85 mm	28 mm	1	25	26,21
3122 8533	Inox		85 mm	33 mm	1	25	26,21
3122 8538	Inox		85 mm	38 mm	1	25	26,21

CERRADURA EMBUTIR PALANCA GANCHO (PUERTAS METAL) / SERRURE ENCASTRÉE LEVIER CROCHETÉ (PORTES MÉTAL) / MORTISE LOCK WITH HOOK  
SERRATURA INCASSATA CON LEVA A GANCIO (PORTE IN METALLO) / FECHADURA EMBUTIR ALAVANCA GANCHO (PORTAS METAL)

S-3122

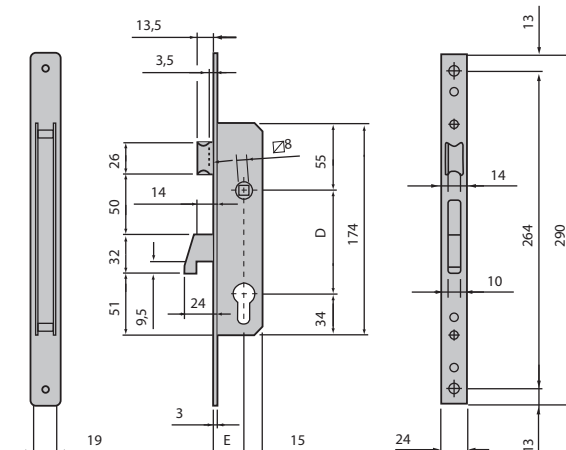

ES Características técnicas: Caja con revestimiento zincado. Frente en acero niquelado. Palanca a GANCHO niquelada. Picaporte reversible niquelado. Contiene tornillo de fijación cerradura y cerradero.

FR Caractéristiques techniques: Boîtier avec revêtement zingué. Partie avant en acier niquelé. Levier à crochet niquelé. Verrou réversible niquelé. Vis de fixation inclus. Serrure et barillet.

EN Technical features: Zinc plated case. Steel nickel front. Nickel hook. Nickel reversible latch. Fixing screw included. Latch and striker.

IT Caratteristiche tecniche: Cassetta con rivestimento zincato. Fronte in acciaio nichelato. Leva a Gancio nichelata. Fermo reversibile in nichel. Contiene vite di fissaggio. Serratura e vano portaserratura.

PT Características técnicas: Caixa com revestimento zincado. Frente em aço niquelado. Alavanca a gancho niquelada. Trinco reversível niquelado. Contem parafuso de fixação. Fechadura e trinco.

Ref		D	E			
3122 8525	Níquel / Nickel / Niquel / Nichel / Níquel	85 mm	25 mm	1	25	12,25



CERRADURA ZÓCALO OVAL CON CERRADERO / SERRURE SOCLE OVALE AVEC BARILLET / OVAL BASE LOCK WITH STRIKER  
SERRATURA CON ZOCCOLO OVALE CON VANO PORTASERRATURA / FECHADURA A ZOCALO OVAL CON TRINCO

S-3123

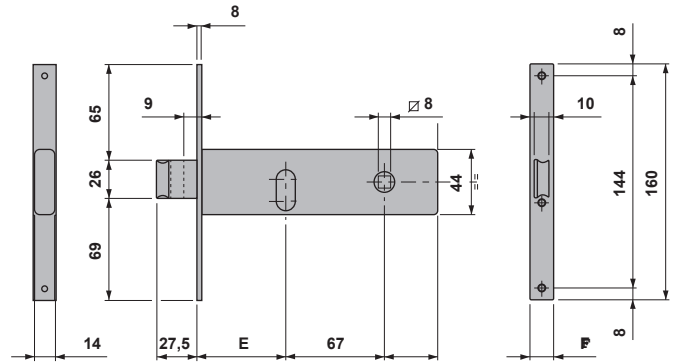

ES Características técnicas: Caja con revestimiento zincado. Frente niquelado. Picaporte niquelado. Contiene tornillo de fijación cerradura y cerradero.

FR Caractéristiques techniques: Boîtier avec revêtement zingué. Partie avant nickelée. Verrou nickelé. Vis de fixation inclus. Serrure et barillet

EN Technical features: zinc plated case. Steel nickel front. Nickel latch. Fixing screw included. Latch and striker

IT Caratteristiche tecniche: Cassetta con rivestimento zincato. Fronte nichelato. Fermo nichelato. Contiene vite di fissaggio. Serratura e vano portaserratura.

PT Características técnicas: Caixa com revestimento zincado. Frente niquelado. Puxador niquelado. Contem parafuso de fixação. Fechadura e trinco.

Ref	F	E			
3123 1670	16 mm	70 mm	1	25	10,48

CERRADURA ZÓCALO CILINDRO PERA CON CERRADERO Y ESCUDO / SERRURE SOCLE OVALE AVEC BARILLET / OVAL BASE LOCK WITH STRIKER  
SERRATURA CON ZOCCOLO OVALE CON VANO PORTASERRATURA / FECHADURA A ZOCALO OVAL CON TRINCO

S-3124

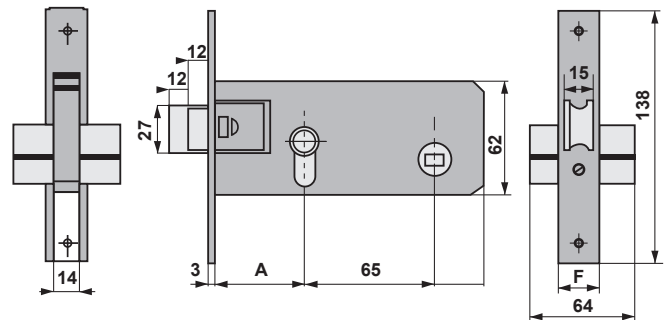

ES Características técnicas: Caja con revestimiento. Frente niquelado. Picaporte reversible niquelado. Contiene tornillo de fijación, cerradura, cerradero y bocallave (escudo).

FR Caractéristiques techniques: Boîtier avec revêtement. Partie avant nickelée. Verrou réglable et réversible. Vis de fixation inclus. Serrure, barillet et plaque de propreté.

EN Technical features: steel nickel front. Nickel reversible and adjustable. Fixing screw included. Latch, striker and shield.

IT Caratteristiche tecniche: Cassetta con rivestimento. Fronte nichelato. Fermo nichelato. Contiene vite di fissaggio. Serratura e vano portaserratura.

PT Características técnicas: Caixa com revestimento. Frente niquelado. Puxador regulavel e reversivel. Contem parafuso de fixação. Fechadura, trinco e boca chave (escudo).

Ref	F	A			
3124 2260	22 mm	60 mm	1	25	14,20
3124 2270	22 mm	70 mm	1	25	14,20



CERRADURA EMBUTIR CON CERRADERO (PUERTAS MADERA) / SERRURE D'INSERTION AVEC BARILLET (PORTES BOIS) / MORTISE CYLINDER LOCK (WOOD DOORS)  
SERRATURA INCASSATA CON VANO PORTASERRATURA (PORTE IN LEGNO) / FECHADURA DE EMBUTIR COM TRINCO (PORTAS MADEIRA)

## S-3125

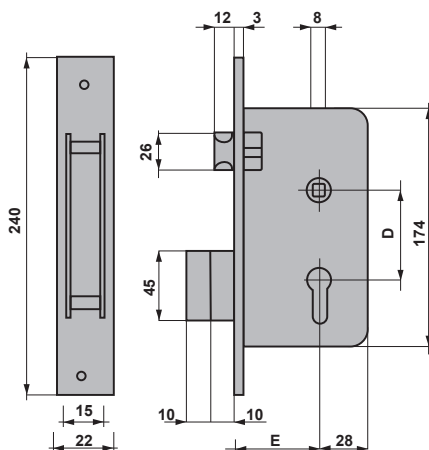

ES Características técnicas: Caja y tapa en acero pintado color negro medio opaco. Frente y cerradero de hierro. Picaporte plano en hierro latonado reversible. Palanca en hierro latonado 2 vueltas. Cerradero cuadrado o redondo. Acabado del frente en color níquel y latón. Contiene tornillos de fijación cerradura y cerradero.

FR Caractéristiques techniques: Boîtier et couvercle en acier peinture. Partie avant, serrure fer. Verrou plat en fer laitoné. Réversible. Levier en fer laitoné 2 retours. Serrure carrée ou ronde. Finition de la partie avant en couleur nickel et laiton. Vis de fixation inclus. Serrure et barillet.

EN Technical features: painted steel case and cover. Brass plated faceplate and striker. Brass deadbolt. Reversible. Brass handle 2 turns. Round or square striker. Brass and nickel front. Fixing screw included. Latch and striker

IT Caratteristiche tecniche: Cassetta e tappo in acciaio pitturato. Fronte e vano portaserratura e ferro ottonato. Fermo piatto in ferro. Reversibile. Leva in ferro ottonato doppio giro. Vano portaserratura quadrato o rotondo. Rifiniture di color nichel e ottone. Contiene viti di fissaggio. Serratura e vano portaserratura

PT Características técnicas: Caixa e tampa em aço pintada. Frente e trinco e ferro cor latao. puxador plano em ferro. Reversível. Alavanca em ferro lcor latao 2 voltas. Trinco quadrado ou redondo. Acabado da Frente em cor Níquel e cor Latao. Contem parafusos de fixação. Fechadura e trinco.

Ref		FRENTE	D	E			
3125 8540	Latón / Laiton / Brass / Ottone / Latao		85 mm	40 mm	1	25	12,45
3125 8545	Latón / Laiton / Brass / Ottone / Latao		85 mm	45 mm	1	25	12,45
3125 8550	Latón / Laiton / Brass / Ottone / Latao		85 mm	50 mm	1	25	12,45
3125 8540N	Níquel / Nickel / Niquel / Nichel / Níquel		85 mm	40 mm	1	25	12,45
3125 8545N	Níquel / Nickel / Niquel / Nichel / Níquel		85 mm	45 mm	1	25	12,45
3125 8550N	Níquel / Nickel / Niquel / Nichel / Níquel		85 mm	50 mm	1	25	12,45

CERRADURA EMBUTIR CON CERRADERO (PUERTAS MADERA) / SERRURE D'INSERTION AVEC BARILLET (PORTES BOIS) / MORTISE CYLINDER LOCK (WOOD DOORS)  
SERRATURA INCASSATA CON VANO PORTASERRATURA (PORTE IN LEGNO) / FECHADURA DE EMBUTIR COM TRINCO (PORTAS MADEIRA)

## S-3100

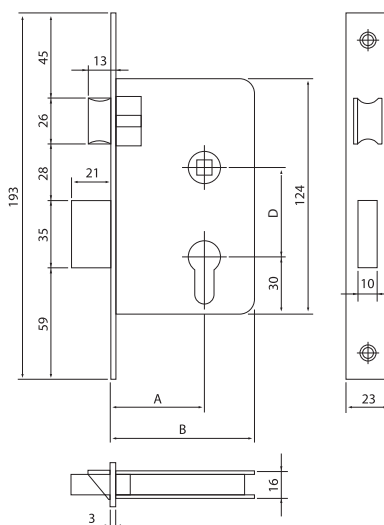

ES Características técnicas: Caja y tapa en acero pintada color negro medio opaco. Frente, cerradero y hierro latonado. Picaporte plano en hierro latonado reversible. Palanca en hierro latonado 2 vueltas. Cerradero cuadrado o redondo. Acabado del frente en color níquel y latón. Contiene tornillos de fijación cerradura y cerradero.

FR Caractéristiques techniques: Boîtier et couvercle en acier peinture noire semi-opaque. Partie avant, serrure et fer laitoné. Verrou plat en fer laitoné. Réversible. Levier en fer laitoné 2 retours. Serrure carrée ou ronde. Finition de la partie avant en couleur nickel et laiton. Vis de fixation inclus. Serrure et barillet.

EN Technical features: painted steel case and cover. Brass plated faceplate and striker. Brass deadbolt. Reversible. Brass handle 2 turns. Round or square striker. Brass and nickel front. Fixing screw included. Latch and striker.

IT Caratteristiche tecniche: Cassetta e tappo in acciaio pitturato di colore nero opaco. Fronte e vano portaserratura e ferro ottonato. Fermo piatto in ferro ottonato. Reversibile. Leva in ferro ottonato doppio giro. Vano portaserratura quadrato o rotondo. Rifiniture di color nichel e ottone. Contiene viti di fissaggio. Serratura e vano portaserratura.

PT Características técnicas: Caixa e tampa em aço pintada cor negro medio opaco. Frente e trinco e ferro cor latao. puxador plano em ferro cor latao. Reversível. Alavanca em ferro lcor latao 2 voltas. Trinco quadrado ou redondo. Acabado da Frente em cor Níquel e cor Latao. Contem parafusos de fixação. Fechadura e trinco.

Ref		FRENTE	D	B	A			
3100 1040	Latón / Laiton / Brass / Ottone / Latao		47 mm	67 mm	40 mm	1	25	13,10
3100 1050	Latón / Laiton / Brass / Ottone / Latao		47 mm	77 mm	50 mm	1	25	14,04
3100 1060	Latón / Laiton / Brass / Ottone / Latao		47 mm	87 mm	60 mm	1	25	14,46





CERRADURA EMBUTIR CON CERRADERO (PUERTAS MADERA) "4 B." / SERRURE D'INSERTION AVEC BARILLET (PORTES BOIS) "4 B."  
 MORTISE CYLINDER LOCK (WOOD DOORS) "4 B." / SERRATURA INCASSATA CON VANO PORTASERRATURA (PORTE IN LEGNO) "4 B."  
 FECHADURA DE EMBUTIR COM TRINCO (PORTAS MADEIRA) "4 B."

S-3126

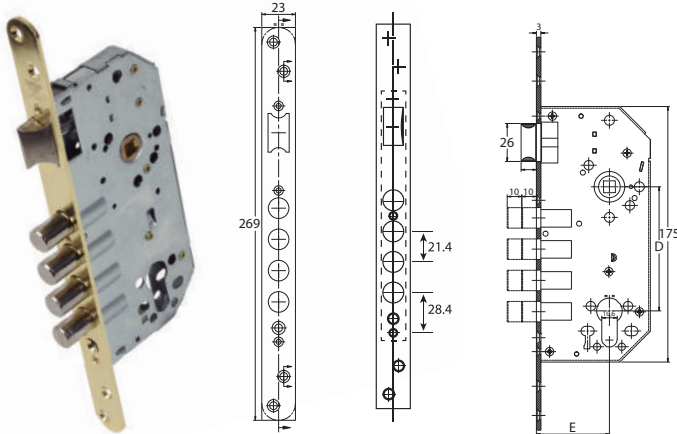

ES Caja y tapa en acero pintada. Frente, cerradero y hierro latonado. Picaporte plano en hierro latonado reversible. Palanca de 4 bulones hierro latonado 2 vueltas. Cerradero cuadrado o redondo. Acabado del frente en color níquel y latón. Contiene tornillos de fijación cerradura y cerradero.

FR Caractéristiques techniques: Boîtier et couvercle en acier. Partie avant, serrure et fer laitoné. Verrou plat en fer laitoné. Réversible. Levier 4 boulons laiton 2 tours. Serrure carrée ou ronde. Finition de la partie avant en couleur nickel et laiton. Vis de fixation inclus. Serrure et barillet.

EN Technical features: painted steel case and cover. Brass plated faceplate and striker. Brass deadbolt. Reversible. 4 bolts brass plated lever 2 turns. Round or square striker. Brass and nickel front. Fixing screw included. Latch and striker

IT Caratteristiche tecniche: Cassetta e tappo in acciaio pitturato. Fronte e vano portaserratura e ferro ottonato. Fermo piatto in ferro ottonato. Reversibile. Leva di 4 bulloni in ferro lattonato, 2 giri. Vano portaserratura quadrato o rotondo. Rifiniture di color nickel e ottone. Contiene viti di fissaggio. Serratura e vano portaserratura

PT Características técnicas: Caixa e tampa em aço pintada. Frente e trinco e ferro cor latao. puxador plano em ferro cor latao. Reversível. Alavanca de 4 parafusos de ferro bronzado 2 voltas. Trinco quadrado ou redondo. Acabado da Frente em cor Níquel e cor Latao. Contem parafusos de fixação. Fechadura e trinco.

Ref		FRENTE	D	E			
3126 5001	Latón / Laiton / Brass / Ottone / Latao		85 mm	50 mm	1	25	20,53
3126 5002	Latón / Laiton / Brass / Ottone / Latao		85 mm	50 mm	1	25	20,53
3126 5001N	Níquel / Nickel / Níquel / Nichel / Níquel		85 mm	50 mm	1	25	20,53
3126 5002N	Níquel / Nickel / Níquel / Nichel / Níquel		85 mm	50 mm	1	25	20,53

CERRADURA DE SOBREPONER / SERRURE EN APPLIQUE / RIM LOCK / FECHADURA DE SOBREPÔR / SERRATURA DI SOVRAPPORRE

S-1494

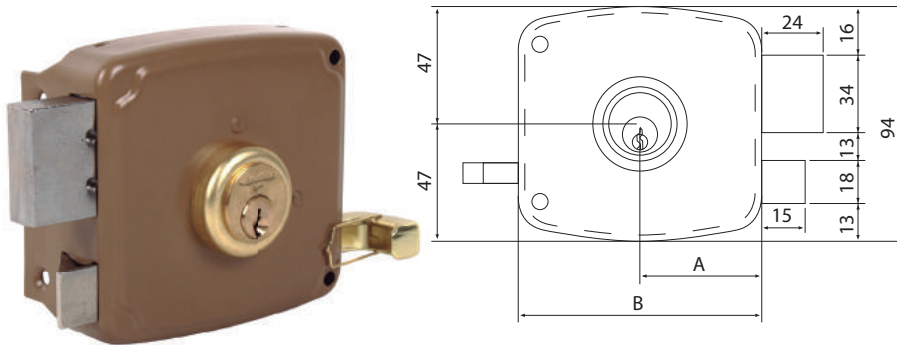

ES Características técnicas: Palanca de acero. Cilindro redondo más 3 llaves (2 vueltas). Cerradero y escudo incluido. Picaporte y tirador interior. Acabado esmaltado. Contiene tornillos para la fijación.

FR Caractéristiques techniques: Levier en acier. Cylindre rond plus 3 clés (2 tours) Serrure et barillet inclus. Verrou et bouclier intérieur. Finition vernie. Contient des vis pour la fixation.

EN Technical features: Steel lever. 3 keys round cylinder (2 turns). Latch and striker included. Interior doorknob. Enamel finished. Retaining screw included.

IT Caratteristiche tecniche: Leva in acciaio. Cilindro rotondo più 3 chiavi (2 giri). Chiusura e schermatura inclusa. Pomello e maniglia interna. Finitura smaltata. Contiene viti per il fissaggio.

PT Características técnicas: Alavanca de aço. Cilindro redondo com 3 chaves (2 voltas). Fechadura e escudo incluído. Trinco e punho interior. Acabamento de esmalte. Contém os parafusos de fixação.

Llave en bruto cerraduras  
 Clé brute serrure  
 Key blank shutter lock  
 Chiave punzonata per serratura  
 Chave em bruto fechadura

Ref	A	B	Apertura		
1494 0080D	40 mm	80 mm	Derecha / Right	1	27,58
1494 0080I	40 mm	80 mm	Izquierda / Left	1	27,58
1494 0100D	50 mm	100 mm	Derecha / Right	1	27,82
1494 0100I	50 mm	100 mm	Izquierda / Left	1	27,82
1494 0120D	60 mm	120 mm	Derecha / Right	1	28,28
1494 0120I	60 mm	120 mm	Izquierda / Left	1	28,28
1494 0140D	70 mm	140 mm	Derecha / Right	1	28,98
1494 0140I	70 mm	140 mm	Izquierda / Left	1	28,98



Ref		
1040 101101	1	0,85



CERRADURA ELÉCTRICA CON CERRADERO Y PULSADOR / SERRURE ÉLECTRIQUE AVEC BARILLET ET BOUTON  
ELECTRIC LOCK WITH STRIKE AND PUSH BUTTON / SERRATURA ELETTRICA CON VANO PORTASERRATURA E PULSANTE  
FECHADURA ELÉCTRICA CON TRINCO E PUXADOR

## S-3130

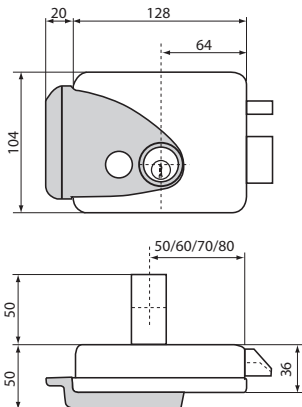
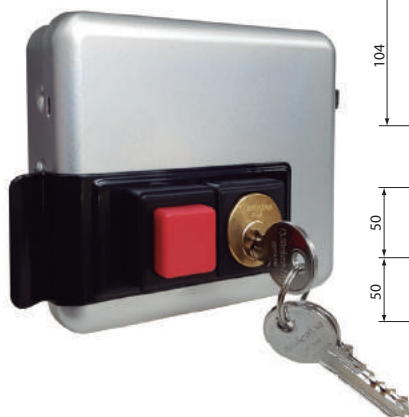

ES Características técnicas: Caja y cerradero de acero pintado en color gris. Pestillo autoblocante. Tensión 12 V ca CE. Electricidad absorbida 2,5A. Botón y cilindro interior. Contiene cerradero, tornillos de fijación y 3 llaves. Certificaciones EN 14846:06: Grado 3 de Seguridad.

FR Caractéristiques techniques: Caisse et barillet en acier peint en couleur grise. Verrou autobloquant. Tension 12 V ca CE. Consommation électrique 2,5A. Bouton et cylindre intérieur. Contient barillet, les vis de fixation et 3 clés. Normes EN 14846:06. Degré de sécurité 3.

EN Technical features: case and latch painted in grey. Self-locking latch. Rate voltage 12V ca CE. Electricity absorbed 2,5A. Switch and interior cylinder. Fixing screw, striker and 3 keys included. Certifications EN14846:06. Security grade 3.

IT Caratteristiche tecniche: Corpo e vano portaserratura in acciaio con verniciatura grigia. Fermo autobloccante. Tensione 12V ca CE. Elettricità assorbita 2,5A. Pulsante e cilindro interno. Contiene vano portaserratura, vite di fissaggio e 3 chiavi. Certificazioni EN 14846:06. Grado 3 di sicurezza.

PT Características técnicas: Caixa e trinco de aço pintado em cor cinzento. Trinco autoblocante. Tensão 12 V ca CE. Electricidade absorvida 2,5A. Botão e cilindro interior. Contem trinco, parafusos de fixação e 3 chaves. Certificações EN 14846:06: Grau 3 de Segurança.

Llave en bruto cerraduras  
Clé brute serrure  
Key blank shutter lock  
Chiave punzonata per serratura  
Chave em bruto fechadura



Ref	Pulsador		
3130 0101D	Derecha / Right	1	72,80
3130 0101I	Izquierda / Left	1	72,80

Ref		
1040 101101	1	0,85

CERRADURA SOBREPONER ADAP 56A / SERRURE SUPERPOSER ADAP 56A / RIM LOCK ADAP 56A  
SERRATURA DA APPLICARE ADAT. 56A / FECHADURA SOBREPOR ADAP 56A

## S-3110

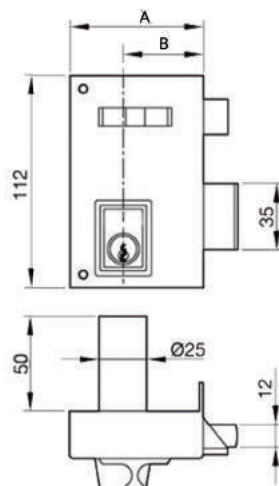

## INCLUIDO / INCLUDED

ES Cerradero, embellecedor de cilindro, tres llaves y componentes de sujección.

FR Serrure, lunette de cylindre, trois clés et composants de fixation.

EN Door strike plate, trim, 3 keys and fixings.

IT Incontro, bocchetta del cilindro, 3 chiavi e dispositivi di fissaggio.

PT Fechadura, espelho, três chaves e componentes de fixação.

Ref	A	B	Apertura		
3110 0561D	60 mm	35 mm	Derecha / Right	1	37,80
3110 0561I	60 mm	35 mm	Izquierda / Left	1	37,80
3110 0562D	70 mm	40 mm	Derecha / Right	1	41,50
3110 0562I	70 mm	40 mm	Izquierda / Left	1	41,50



ESCUDO ANTITALADRO CERRADO CON TORNILLOS / BOUCLIER ANTI PERFORATION FERMETURE À VIS / LOCK SHIELD WITH SCREWS  
 PROTEZIONE ANTIEFFRAZIONE CON VITI / ESCUDO ANTITALADRO FECHADO COM PARAFUSOS



ES Características técnicas: Fabricado en acero. Tornillo de fijación incluidos. Acabado latonado y níquel.

FR Caractéristiques techniques: Fabriqué en acier. Vis de fixation inclus. Finition laiton et nickel.

EN Technical features: steel body. Fixing screw included. Nickel and brass finished.

IT Caratteristiche tecniche: Prodotto in acciaio. Vite di fissaggio inclusa. Finiture ottonate e nichel.

PT Características técnicas: Fabricado en aço. Parafuso de fixação incluidos. Acabado de latão e níquel.

Ref				
<b>3110 9995</b>	Latón / Laiton / Brass / Ottone / Latao	1	<b>11,10</b>	
<b>3110 9995N</b>	Níquel / Nickel / Niquel / Nichel / Níquel	1	<b>10,80</b>	

ABREPUERTAS ELÉCTRICO REVERSIBLE CON FRONTAL / OUVRE-PORTE ÉLECTRIQUE RÉVERSIBLE AVEC PARTIE AVANT  
 ELECTRIC AND REVERSIBLE LOCKS WITH PLATES / APRIORTA ELETTRICO REVERSIBILE CON FRONTALE  
 ABREPORTAS ELÉCTRICO REVERSIVEL COM FRONTAL



ES Características técnicas: Tensión 12V AC o DC. Color gris. Cuerpo principal inoxidable. Frontal en acero inoxidable. Contiene frontal y tornillos para la fijación del frontal.

FR Caractéristiques techniques: Tension 12V AC ou DC. Couleur grise. Corps principal inoxydable. Partie avant en acier inoxydable. Contient partie avant et vis pour la fixation de la partie avant.

EN Technical features: Rate voltage 12V AC or DC. Grey color. Stainless steel body. Stainless steel front. Faceplate and faceplate fixing screw

IT Caratteristiche tecniche: tensione 12V AC o DC. Colore grigio. Corpo principale inossidabile. Frontale in acciaio inossidabile. Contiene frontale e viti di regolazione

PT Características técnicas: Tensão 12V AC o DC. Cor cinzento. Corpo principal inoxidável. Frontal em aço inoxidável. Contem Frontal e parafusos para a fixação do frontal.

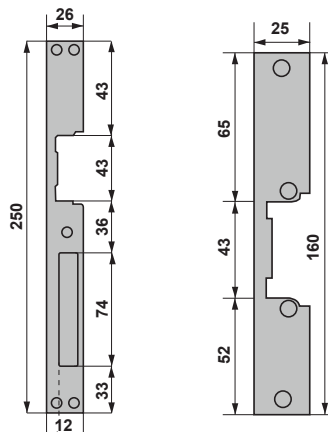

Ref	⚡	A		
<b>3130 0250</b>	AC/DC	250 mm	1	<b>30,55</b>



CERROJO BOTÓN/LLAVE R/105 / SERRURE BOUTON/CLE R/105 / DOOR BOLT PUSH BUTTON/KEY R/105  
 CHIAVISTELLO PULSANTE/CHIAVE R/105 / FERROLHO BOTÃO/CHAVE R/105

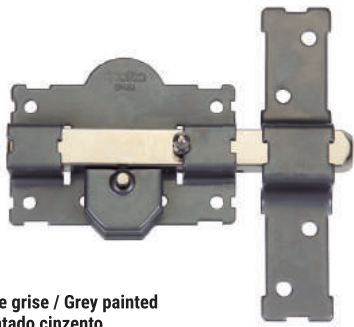

Pintado gris / Peinture grise / Grey painted  
 Verniciato grigio / Pintado cinzento

Ref	A		
3110 2050	50 mm	1	25,60
3110 2070	70 mm	1	29,40

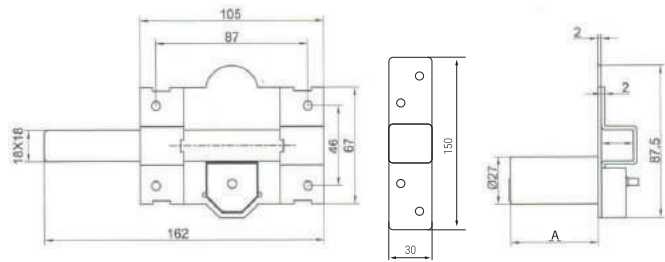

Grupos de llaves iguales / Groupe de clés identiques / Same key sets  
 Gruppi con la medesima chiave / Grupos de chaves iguais

Ref	A		
3110 2050.AAA	50 mm	1	26,80
3110 2070.AAA	70 mm	1	30,65

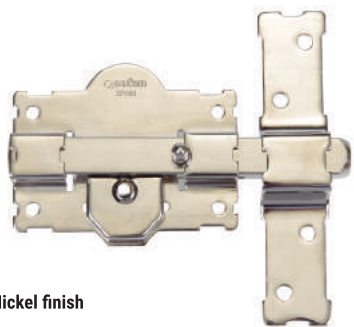

Niquelado / Nickel / Nickel finish  
 Nichelado / Niquelado

Ref	A		
3110 2050N	50 mm	1	27,25
3110 2070N	70 mm	1	30,95

ES Cerrojo con acabado pintado, barra en acero calibrado 18 mm, placa en acero 2 mm, cerradero en acero de 3 mm. Cilindro redondo latón en 50 y 70 mm

FR Serrure finition peinture, barre en acier calibré 18 mm, plaque en acier 2 mm, fermeture en acier de 3 mm Cylindre rond laiton en 50 et 70 mm.

EN Door bolt with painted finish, 18 mm gauge steel bolt, 2mm steel sheet, 3mm steel strike. Round brass cylinder available in 50 and 70 mm.

IT Chiavistello con finitura verniciata, barra in acciaio calibrato 18mm, placca in acciaio 2mm, chiusura in acciaio da 3mm. Cilindro rotondo in ottone di 50 e 70 mm.

PT Ferrolho com acabamento pintado, barra de aço calibrado 18 mm, chapa de aço de 2 mm, marco de aço de 3 mm. Cilindro redondo em latão de 50 e 70 mm.

CERROJO LLAVE/LLAVE L/105 / SERRURE CLE/CLE L/105 / DOOR BOLT KEY/KEY L/105  
 CHIAVISTELLO CHIAVE/CHIAVE L/105 / FERROLHO CHAVE/CHAVE L/105

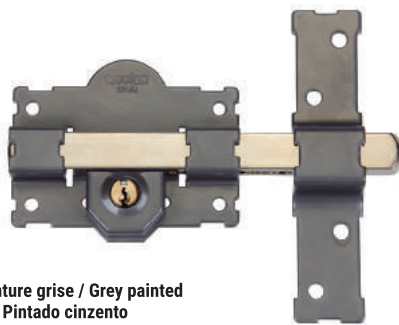

Pintado gris / Peinture grise / Grey painted  
 Verniciato grigio / Pintado cinzento

Ref	A		
3110 3050	50 mm	1	26,36
3110 3070	70 mm	1	29,52

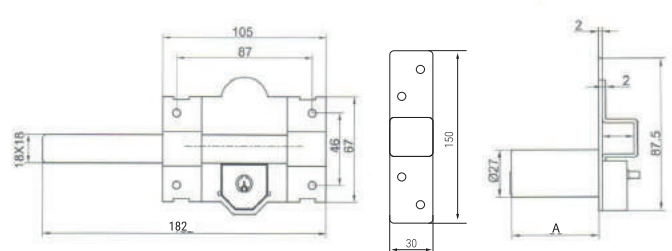

Grupos de llaves iguales / Groupe de clés identiques / Same key sets  
 Gruppi con la medesima chiave / Grupos de chaves iguais

Ref	A		
3110 3050.AAA	50 mm	1	27,60
3110 3070.AAA	70 mm	1	30,75

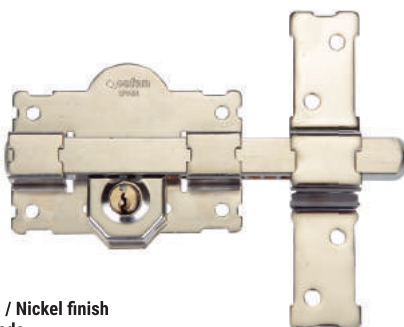

Niquelado / Nickel / Nickel finish  
 Nichelado / Niquelado

Ref	A		
3110 3050N	50 mm	1	28,10
3110 3070N	70 mm	1	21,20

ES Cerrojo con acabado pintado, barra en acero calibrado 18 mm, placa en acero 2 mm, cerradero en acero de 3 mm. Cilindro redondo latón en 50 y 70 mm.

FR Serrure finition peinture, barre en acier calibré 18 mm, plaque en acier 2 mm, fermeture en acier de 3 mm Cylindre rond laiton en 50 et 70 mm.

EN Door bolt with painted finish, 18 mm gauge steel bolt, 2mm steel sheet, 3mm steel strike. Round brass cylinder available in 50 and 70 mm.

IT Chiavistello con finitura verniciata, barra in acciaio calibrato 18mm, placca in acciaio 2mm, chiusura in acciaio da 3mm. Cilindro rotondo in ottone di 50 e 70 mm.

PT Ferrolho com acabamento pintado, barra de aço calibrado 18 mm, chapa de aço de 2 mm, marco de aço de 3 mm. Cilindro redondo em latão de 50 e 70 mm.



CERRADURAS PERSIANAS DE METAL / SERRURES PERSIENNES EN MÉTAL / LOCKS FOR ROLLING SHUTTERS  
SERRATURE PER PERSIANE METALLICHE / FECHADURAS PERSIANAS DE METAL

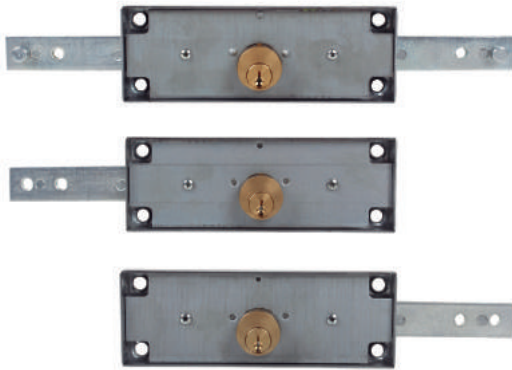

Ref		
3130 0171	1	18,35
3130 0171.AAA	1	19,22
Ref		
3130 0172	1	17,91
3130 0172.AAA	1	18,78
Ref		
3130 0173	1	17,91
3130 0173.AAA	1	18,78

Grupos de llaves iguales  
Groupe de cles identiques  
Same key sets  
Gruppi con la medesima chiave  
Grupos de chaves iguais

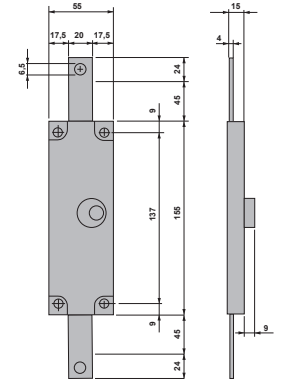

LLAVE SERRETA EN BRUTO CERRADURA PERSIANA / CLÉ DE SERRURE BRUTE SERRURE PERSIENNE  
KEY BLANK ROLLER SHUTTER LOCK / CHIAVE PUNZONATA A 5 FORI, PER SERRATURA PERSIANA  
CHAVE SERRETA EM BRUTO FECHADURA PERSIANA



Ref		
3130 9999	5	0,76

ES Características técnicas: Cuerpo en acero zincado. Palancas en acero zincado. Cilindro de latón. 3 llaves en latón niquelado. Modelos central, lateral derecho y lateral izquierdo.

FR Caractéristiques techniques: Corps en acier zingué. Leviers en acier zingué. Cylindre en laiton. 3 clés en laiton nickelé. Modèle central, latéral droit et latéral gauche.

EN Technical features: zinc plate steel case. Steel deadbolts. Brass cylinder. 3 nickel plated brass keys. Central, right and left sideways.

IT Caratteristiche tecniche: Corpo in acciaio zincato. Leve in acciaio zincato. Cilindro in ottone. 3 chiavi in ottone nichelato. Modelli: centrale, laterale destro e laterale sinistro.

PT Características técnicas: Corpo em aço zincado. Alavancas em aço zincado. Cilindro de latao. 3 chaves em latao niquelado. Modelos Central, lateral direito e lateral esquerdo.

KIT DE IGUALAMIENTO Y AMAESTRAMIENTO DE CILINDROS / KIT D'APPAREILLAGE ET D'APPRENTISSAGE DE CYLINDRES / KIT FOR CYLINDERS TRAINING  
KIT COMPONENTI E AMAESTRAMENTO CILINDRI / KIT DE IGUALAMENTO E AMAESTRADOR DE CILINDROS



ES Contenido: Pernos diferentes medidas y contrapernos. Muelles y tapones. Medidor. Grupillas.

FR Contenu: pitons de différentes mesures et contre-pitons. Ressorts et bouchons. Mesure. Goupilles.

EN Contenido: Pistoncini di differenti misure e contropistoncini. Molle e tappi. Metro. Anelli elastici

IT Content: Different sizes pins. Springs and caps. Metro. Pins

PT Conteudo: pernos diferentes medidas e contrapernos. Molas e tampas. Medidor. Freios.

Ref		
3110 9998	1	436,80

LLAVE SERRETA 5 PITONES EN BRUTO / CLÉ DE SERRURE 5 PITONS BRUTS / 5-PIN KEY BLANK  
CHIAVE PUNZONATA A 5 FORI, PER SERRATURA / CHAVE SERRETA 5 PINOS EM BRUTO

- S-3102
- S-3103
- S-3104
- S-3105
- S-3106



Ref		
3104 9999	5	0,76

LLAVE EN BRUTO PARA CILINDRO DE SEGURIDAD / CLÉ BRUTE POUR CYLINDRE DE SÉCURITÉ / KEY BLANK FOR SECURITY CYLINDER  
CHIAVE GREZZA PER CILINDRO DI SICUREZZA / CHAVE EM BRUTO PARA CILINDRO DE SEGURANÇA

- S-3101
- S-3108



Ref		
3101 9999	5	2,86





CIERRAPUERTAS / FERME-PORTES / DOOR CLOSER / CHIUDIPIORTA / FECHAPORTAS

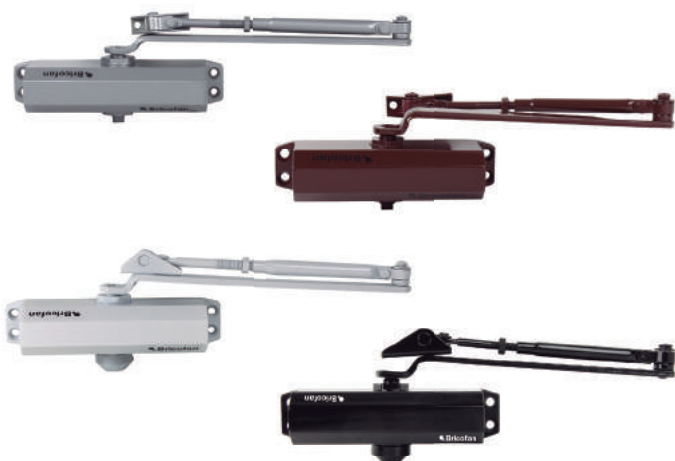

ES Características técnicas: Cuerpo monobloque en zamack. Brazo en acero. Muelle en acero especial lubricado. Válvulas de reglaje con dispositivo termostático independiente. Válvulas de sobrecarga. Modelos para puertas de 65 y 85 kg. con medidas de 1050 mm. Fuerza de cierre 3. Cierre desde 180° hasta 15°. Contiene tornillos de fijación. Acabados en color plata, bronce y negro.

FR Caractéristiques techniques: Corps monobloc zamack. Bras en acier. Ressort en acier spécial lubrifié. Valves de réglage avec dispositif thermostatique indépendant. Valves de surcharge. Modèles pour portes de 65 et de 85 kg avec des mesures de 1050mm. Force de fermeture 3. Fermeture de 180° à 15°. Contient des vis de fixation finition en couleur argent, bronze et noir.

EN Technical features: Monoblock body in zamack. Steel arm. Special steel spring in oil bath independent adjustment valves with thermostatic device. Overload safety valve. 65 and 85 kg doors with 1050mm. Closing strength 3. Closing speed between 180° to 15°. Fixing screw finished in plate, brass and black color.

IT Caratteristiche tecniche: Corpo monoblocco in Zamak. Braccio in acciaio. Molla in acciaio speciale lubrificato. Valvole di regolazione con dispositivo termostatico indipendente. Valvole di sovraccarico. Modelli per porte da 65 e 85Kg con misure da 1050mm. Forza di chiusura 3. Chiusura da 180° a 15°. Contiene viti di fissaggio con rifiniture di color argento, bronzo e nero.

PT Características técnicas: Corpo monobloque em zamack. Braço em aço. Mola em aço especial lubrificado. Válvulas de regulação com dispositivo termostático independente. Válvulas de sobrecarga. Modelos para Portas de 65 y 85Kg. con medidas de 1050 mm. Força de fecho 3. Fecho desde 180° hasta 15°. Acabados em cor prata, bronze e negro.

40 - 65 Kg

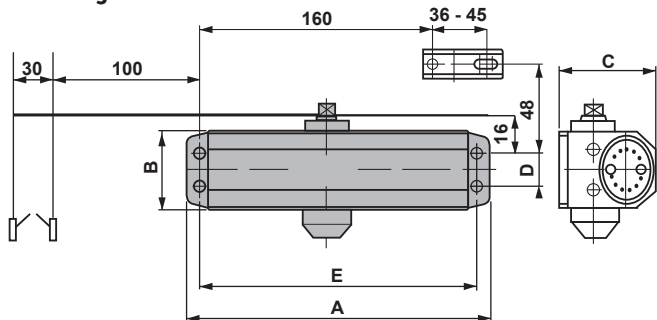

60 - 85 Kg

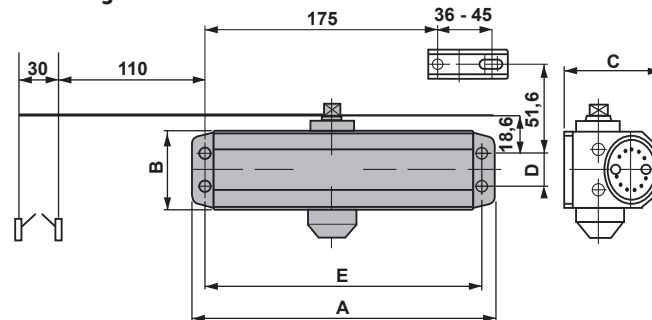

Fuerza de cierre 3 / Force de fermeture 3 / Closing strength 3 / Forza di chiusura 3 / Força de fecho 3

Sin retención / Sans retenue / Without retention / Senza fermo chiusura / Sem retenção

Ref		A	B	C	D	E			
3130 0141	Plata / Argent / Plate / Argento / Prata	180 mm	40 mm	63 mm	19 mm	165 mm	1	38,88	40-65 Kg
3130 0142	Bronce / Bronze / Brass / Bronzo / Bronze	180 mm	40 mm	63 mm	19 mm	165 mm	1	38,88	
3130 0145	Blanco / Blanc / White / Bianco / Branco	180 mm	40 mm	63 mm	19 mm	165 mm	1	38,88	
3130 0121	Plata / Argent / Plate / Argento / Prata	228 mm	44,5 mm	72 mm	19 mm	208 mm	1	46,35	60-85 Kg
3130 0122	Bronce / Bronze / Brass / Bronzo / Bronze	228 mm	44,5 mm	72 mm	19 mm	208 mm	1	46,35	
3130 0135	Blanco / Blanc / White / Bianco / Branco	228 mm	44,5 mm	72 mm	19 mm	208 mm	1	46,35	

Con retención / Avec retenue / With retention / Con fermo chiusura / Com retenção

Ref		A	B	C	D	E			
3130 0143	Plata / Argent / Plate / Argento / Prata	180 mm	40 mm	63 mm	19 mm	165 mm	1	38,88	40-65 Kg
3130 0144	Bronce / Bronze / Brass / Bronzo / Bronze	180 mm	40 mm	63 mm	19 mm	165 mm	1	38,88	
3130 0146	Blanco / Blanc / White / Bianco / Branco	180 mm	40 mm	63 mm	19 mm	165 mm	1	38,88	
3130 0147	Negro / Noir / Black / Nero / Preto	180 mm	40 mm	63 mm	19 mm	165 mm	1	38,88	
3130 0131	Plata / Argent / Plate / Argento / Prata	228 mm	44,5 mm	72 mm	19 mm	208 mm	1	46,35	60-85 Kg
3130 0132	Bronce / Bronze / Brass / Bronzo / Bronze	228 mm	44,5 mm	72 mm	19 mm	208 mm	1	46,35	
3130 0136	Blanco / Blanc / White / Bianco / Branco	228 mm	44,5 mm	72 mm	19 mm	208 mm	1	46,35	



ANTIPÁNICO SUPERFICIE CIERRE 1 PUNTO C. NEGRO / ANTIPANIQUE SURFACE FERMETURE 1 POINT C. NOIR  
 PANIC BAR SURFACE LOCK 1 POINT RAIL BLACK / CHIUSURA ANTIPANICO 1 PUNTO C. NERA / ANTIPÁNICO SUPERFÍCIE FECHO 1 PONTO C. PRETO

1 PUNTO / POINT / POINT / PUNTO / PONTO

EN 1125:2008  
 3-7-7-0-1-4-2-2-A-A

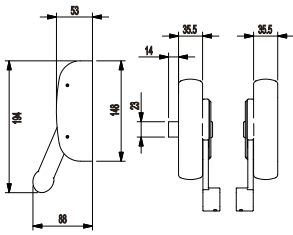

Ref		
3140 0501	1	165,98

2 PUNTOS / 2 POINTS / 2 POINTS / 2 PUNTI / 2 PONTO

EN 1125:2008  
 3-7-7-0-1-4-2-2-A-A

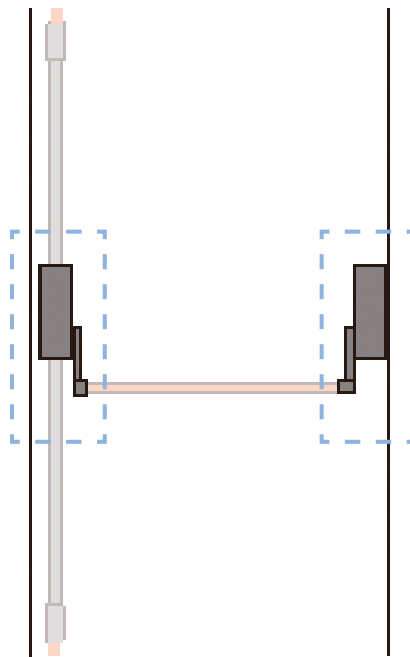
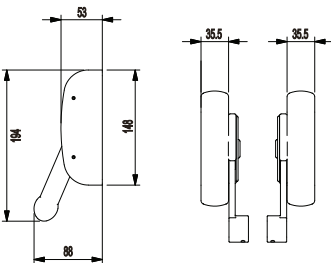

Ref		
3140 0502	1	165,98



CIERRE ANTIPÁNICO SUPERFICIE ARRIBA/ABAJO 2 PUNTOS / FERMETURE ANTI-PANIQUE HAUT/BAS / PANIC BAR UP/DOWN  
 MANIGLIONE ANTIPANICO SOPRA / SOTTO / BARRA DE FECHO ANTIPÁNICO SUPERFICIE ACIMA / ABAIXO

CE EN 1125:2008

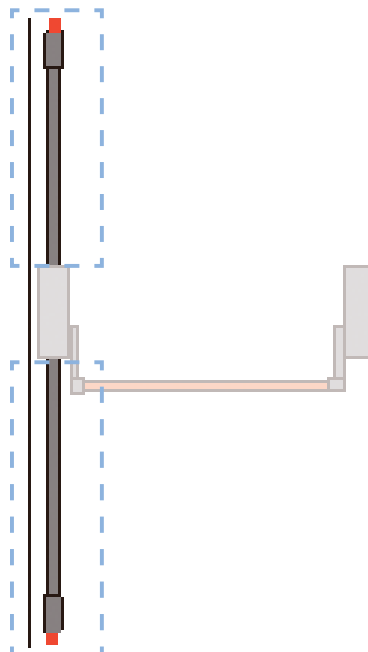
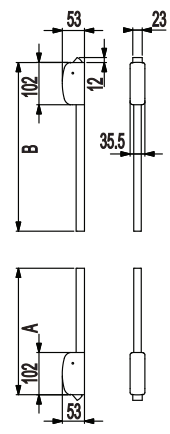

Ref	MODEL		
3140 0550	2 puntos / points / points / punti / ponto	1	117,20

MANIVELA+CILINDRO ANTIPÁNICO / MANIVELLE + CYLINDRE ANTIPANIQUE / HANDLE + CYLINDER FOR PANIC DEVICES  
 MANOVELLA + CILINDRO ANTIPANICO / MANIVELA + CILINDRO ANTIPÁNICO

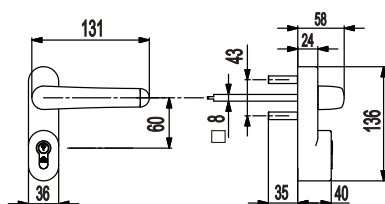

Ref	MODEL		
3140 0600		1	63,77
3140 0602	Siempre Cerrado / Toujours fermé / Always closed Sempre chiuso / Sempre fechado	1	67,27

TUBO ROJO ANTIPÁNICO / TUBE ROUGE ANTIPANIQUE / RED PANIC BAR / TUBO ROSSO ANTIPANICO / TUBO VERMELHO ANTIPÁNICO



Ref	↔		
3140 0701	950 mm	1	21,65
3140 0702	1150 mm	1	23,59



CANDADO DE LATÓN QUALITY PLUS / CADENAS EN LAITON QUALITY PLUS / BRASS PADLOCK QUALITY PLUS  
LUCCHETTO IN OTTONE QUALITÀ PLUS / CADEADO DE LATÃO QUALITY PLUS

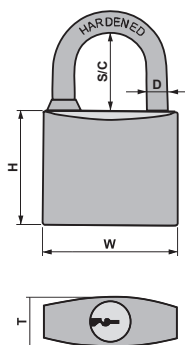

2 LLAVES / 2 KEYS



ES Candado fabricado en latón, arco de acero endurecido y anti-corrosivo. Mecanismo de alta seguridad para evitar el robo.  
FR Fabriqué en laiton. Arc en acier trempé, anticorrosion. Mécanisme anti-voil de haute sécurité.  
EN Rust resistant brass body padlock with hardened anticorrosive steel shackle. Theft proof high security mechanism.  
IT Costruito in ottone, arco in acciaio speciale, anti-taglio, anti-corrosione. Meccanismo di alta sicurezza, antifurto.  
PT Cadeado feito de latão, manilha em aço endurecido e anti-corrosivo. Mecanismo de alta segurança para evitar roubo.

Ref	W	H	T	D	S/C				
1040 3107	20 mm	20,0 mm	10 mm	3,5 mm	12 mm	1	12	3,15	✓
1040 3108	25 mm	22,0 mm	11 mm	4,0 mm	14 mm	1	12	3,88	✓
1040 3109	30 mm	27,0 mm	14 mm	5,0 mm	17 mm	1	12	4,48	✓
1040 3110	40 mm	33,5 mm	15 mm	6,3 mm	23 mm	1	12	6,80	✓
1040 3111	50 mm	42,0 mm	17 mm	8,0 mm	30 mm	1	6	10,62	✓
1040 3112	60 mm	43,0 mm	19 mm	9,5 mm	35 mm	1	6	14,13	✓

Grupos de llaves iguales / Groupe de clés identiques / Same key sets  
Gruppi con la medesima chiave / Grupos de chaves iguais

Ref	W	H	T	D	S/C				
1040 3108KA	25 mm	22,0 mm	11 mm	4,0 mm	14 mm	1	12	3,81	✓
1040 3109KA	30 mm	27,0 mm	14 mm	5,0 mm	17 mm	1	12	4,48	✓
1040 3110KA	40 mm	33,5 mm	15 mm	6,3 mm	23 mm	1	12	6,80	✓
1040 3111KA	50 mm	42,0 mm	17 mm	8,0 mm	30 mm	1	6	10,79	✓

CANDADO DE LATÓN A/LARGO QUALITY PLUS / CADENAS EN LAITON ARC LONG QUALITY PLUS / BRASS PADLOCK LONG SHACKLE QUALITY PLUS  
LUCCHETTO IN OTTONE ARCO LUNGO QUALITÀ PLUS / CADEADO DE LATÃO ARCO LONGO QUALITY PLUS



2 LLAVES / 2 KEYS



ES Candado fabricado en latón, arco de acero endurecido y anti-corrosivo. Mecanismo de alta seguridad para evitar el robo.  
FR Fabriqué en laiton. Arc en acier trempé, anticorrosion. Mécanisme anti-voil de haute sécurité.  
EN Rust resistant brass body padlock with hardened anticorrosive steel shackle. Theft proof high security mechanism.  
IT Costruito in ottone, arco in acciaio speciale, anti-taglio, anti-corrosione. Meccanismo di alta sicurezza, antifurto.  
PT Cadeado feito de latão, manilha em aço endurecido e anti-corrosivo. Mecanismo de alta segurança para evitar roubo.

Ref	W	H	T	D	S/C				
1040 3125	20 mm	20,0 mm	11 mm	3,5 mm	21,5 mm	1	12	3,26	✓
1040 3126	25 mm	24,0 mm	13 mm	4,0 mm	24,0 mm	1	12	3,98	✓
1040 3127	30 mm	27,0 mm	15 mm	4,8 mm	52,0 mm	1	6	4,78	✓
1040 3128	40 mm	33,0 mm	17 mm	6,3 mm	52,0 mm	1	6	7,36	✓
1040 3129	50 mm	40,0 mm	19 mm	7,0 mm	48,0 mm	1	6	11,59	✓

Grupos de llaves iguales / Groupe de clés identiques / Same key sets  
Gruppi con la medesima chiave / Grupos de chaves iguais

Ref	W	H	T	D	S/C				
1040 3125KA	20 mm	20,0 mm	12 mm	3,5 mm	21,5 mm	1	12	3,20	✓
1040 3126KA	25 mm	24,0 mm	15 mm	4,0 mm	24,0 mm	1	12	3,90	✓
1040 3127KA	30 mm	27,0 mm	15 mm	4,8 mm	52,0 mm	1	6	4,78	✓
1040 3128KA	40 mm	33,0 mm	17 mm	6,3 mm	52,0 mm	1	6	7,36	✓
1040 3129KA	50 mm	40,0 mm	19 mm	7,0 mm	48,0 mm	1	6	11,59	✓

CANDADO INOXIDABLE QUALITY PLUS / CADENAS INOXYDABLE QUALITY PLUS / STAINLESS PADLOCK QUALITY PLUS  
LUCCHETTO INOSSIDABILE QUALITÀ PLUS / CADEADO INOXIDÁVEL QUALITY PLUS 30MM

INOX



2 LLAVES / 2 KEYS



2 LLAVES / 2 KEYS



ES Candado fabricado en latón, arco de acero endurecido y anti-corrosivo. Mecanismo de alta seguridad para evitar el robo.  
FR Fabriqué en laiton. Arc en acier trempé, anticorrosion. Mécanisme anti-voil de haute sécurité.  
EN Rust resistant brass body padlock with hardened anticorrosive steel shackle. Theft proof high security mechanism.  
IT Costruito in ottone, arco in acciaio speciale, anti-taglio, anti-corrosione. Meccanismo di alta sicurezza, antifurto.  
PT Cadeado feito de latão, manilha em aço endurecido e anti-corrosivo. Mecanismo de alta segurança para evitar roubo.

Ref	W	H	T	D	S/C				
1040 3206	30 mm	29,0 mm	13 mm	5,0 mm	17 mm	1	12	7,09	✓
1040 3208	40 mm	33,0 mm	14 mm	6,0 mm	22 mm	1	6	9,90	✓
1040 3210	50 mm	41,0 mm	17 mm	8,5 mm	29 mm	1	6	16,95	✓

ARCO EXTRA LARGO / ARC LONG / LONG SHACKLE / ARCO LUNGO / ARCO LONGO

Ref	W	H	T	D	S/C				
1040 3207	30 mm	29,0 mm	13 mm	5,0 mm	56 mm	1	12	7,44	✓
1040 3209	40 mm	33,0 mm	14 mm	6,0 mm	130 mm	1	6	11,25	✓



CANDADO LAMINADO ANTIHUMEDAD QUALITY PLUS / CADENAS LAMINE ANTIHUMIDITÉ QUALITY PLUS  
 ANTI-MOISTURE LAMINATED PADLOCK QUALITY PLUS / LUCCHETTO LAMINATO ANTI-UMIDITÀ QUALITÀ PLUS  
 CADEADO LAMINADO ANTI-HUMIDADE QUALITY PLUS

ES Candado fabricado en latón, arco de acero endurecido y anti-corrosivo. Mecanismo de alta seguridad para evitar el robo.  
 FR Fabriqué en laiton. Arc en acier trempé, anticorrosion. Mécanisme anti-vol de haute sécurité.  
 EN Rust resistant brass body padlock with hardened anticorrosive steel shackle. Theft proof high security mechanism.  
 IT Costruito in ottone, arco in acciaio speciale, anti-taglio, anti-corrosione. Meccanismo di alta sicurezza, antifurto.  
 PT Cadeado feito de latão, manilha em aço endurecido e anti-corrosivo. Mecanismo de alta segurança para evitar roubo.

**ANTIHUMEDAD / ANTIHUMIDITÉ / ANTI-MOISTURE / ANTI-UMIDITÀ / ANTIHUMIDADE**



2 LLAVES / 2 KEYS

Ref	W	H	T	D	S/C				
1040 3226	40 mm	38,0 mm	29 mm	8 mm	25 mm	1	12	7,54	✓
1040 3227	50 mm	44,0 mm	29 mm	10 mm	38 mm	1	6	9,07	✓

CANDADO ANTIPALANCA QUALITY PLUS / CADENAS ANTI-LEVIER QUALITY PLUS / ANTI-LEVER PADLOCK QUALITY PLUS  
 LUCCHETTO ANTISCASSO QUALITÀ PLUS / CADEADO ANTI ALAVANCA QUALITY PLUS

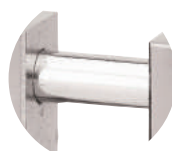
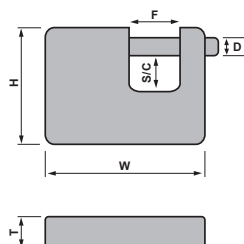

ACERO CROMADO  
CHROMED STEEL



ACERO  
STEEL



2 LLAVES / 2 KEYS

Ref	W	H	T	D	F	S/C				
1040 3113	70 mm	41,0 mm	17 mm	8,0 mm	24 mm	30 mm	1	6	24,36	✓
1040 3114	90 mm	43,0 mm	19 mm	9,5 mm	24 mm	35 mm	1	6	32,31	✓

CANDADO EXTRA ACERO BLINDADO NIQUELADO / CADENAS EXTRA ACIER BLINDÉ NICHELE / EXTRA ARMOURED NICKEL-PLATED STEEL PADLOCK  
 LUCCHETTO EXTRA ARCO BLINDATO NICHELATO / CADEADO EXTRA ARCO BLINDADO NÍQUEL

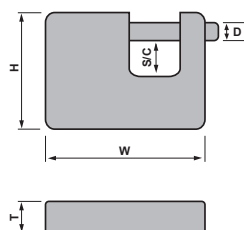

ACERO CROMADO  
CHROMED STEEL



ACERO CEMENTADO  
CEMENTED STEEL



5 LLAVES / 5 KEYS

Ref	W	H	T	D	S/C	X				
1040 3221	84 mm	70 mm	28 mm	12,5 mm	16 mm	35 mm	1	6	20,61	✓





LLAVE BRUTO CANDADO 20MM / CLÉ BRUTE CADENAS 20MM / 20MM PADLOCK KEY BLANK  
 CHIAVE VUOTA PER LUCCHETTO / CHAVE EM BRUTO PARA CADEADO 20MM



COMPATIBLE CON CANDADO / COMPATIBLE AVEC LE CADENAS / SUITABLE FOR PADLOCK  
 COMPATIBLE CON LUCCHETTO / COMPATÍVEL COM CADEADO:  
**(ref 10403107-25-25KA)**

Ref	↔	📏	📦	📊
1040 3150	20 mm	1	1	0,40

LLAVE BRUTO CANDADO 25MM / CLÉ BRUTE CADENAS 25MM / 25MM PADLOCK KEY BLANK  
 CHIAVE VUOTA PER LUCCHETTO / CHAVE EM BRUTO PARA CADEADO 25MM



COMPATIBLE CON CANDADO / COMPATIBLE AVEC LE CADENAS / SUITABLE FOR PADLOCK  
 COMPATIBLE CON LUCCHETTO / COMPATÍVEL COM CADEADO:  
**(ref 10403108-26-08KA-26KA)**

Ref	↔	📏	📦	📊
1040 3151	25 mm	1	1	0,40

LLAVE BRUTO CANDADO 30MM / CLÉ BRUTE CADENAS 30MM / 30MM PADLOCK KEY BLANK  
 CHIAVE VUOTA PER LUCCHETTO / CHAVE EM BRUTO PARA CADEADO 30MM



COMPATIBLE CON CANDADO / COMPATIBLE AVEC LE CADENAS / SUITABLE FOR PADLOCK  
 COMPATIBLE CON LUCCHETTO / COMPATÍVEL COM CADEADO:  
**(ref 10403109-27-09KA-27KA)**

Ref	↔	📏	📦	📊
1040 3152	30 mm	1	1	0,40

LLAVE BRUTO CANDADO 40MM / CLÉ BRUTE CADENAS 40MM / 40MM PADLOCK KEY BLANK  
 CHIAVE VUOTA PER LUCCHETTO / CHAVE EM BRUTO PARA CADEADO 40MM



COMPATIBLE CON CANDADO / COMPATIBLE AVEC LE CADENAS / SUITABLE FOR PADLOCK  
 COMPATIBLE CON LUCCHETTO / COMPATÍVEL COM CADEADO:  
**(ref 10403110-28-10KA-28KA)**

Ref	↔	📏	📦	📊
1040 3153	40 mm	1	1	0,40

LLAVE BRUTO CANDADO 50MM / CLÉ BRUTE CADENAS 50MM / 50MM PADLOCK KEY BLANK  
 CHIAVE VUOTA PER LUCCHETTO / CHAVE EM BRUTO PARA CADEADO 50MM



COMPATIBLE CON CANDADO / COMPATIBLE AVEC LE CADENAS / SUITABLE FOR PADLOCK  
 COMPATIBLE CON LUCCHETTO / COMPATÍVEL COM CADEADO:  
**(ref 10403111-12-29-11KA-29KA)**

Ref	↔	📏	📦	📊
1040 3154	50 mm	1	1	0,40



LLAVE BRUTO CANDADO SEG. 84MM / CLÉ BRUTE CADENAS SEG. 84MM / 84MM SAFETY PADLOCK KEY BLANK  
 CHIAVE VUOTA PER LUCCHETTO DI SICUREZZA 84MM / CHAVE EM BRUTO PARA CADEADO SEGURANÇA 84MM



COMPATIBLE CON CANDADO / COMPATIBLE AVEC LE CADENAS / SUITABLE FOR PADLOCK  
 COMPATIBLE CON LUCCHETTO / COMPATÍVEL COM CADEADO:

(ref 10403221)

Ref	↔	📏	📦	📊
1040 3155	84 mm	1	1	1,20

LLAVE BRUTO CANDADO LAMINADO 40/50MM / CLÉ BRUTE CADENAS LAMINE 40/50MM / 40/50MM LAMINATED PADLOCK KEY BLANK  
 CHIAVE VUOTA PER LUCCHETTO LAMINATO 40/50MM / CHAVE EM BRUTO PARA CADEADO LAMINADO 40/50MM



COMPATIBLE CON CANDADO / COMPATIBLE AVEC LE CADENAS / SUITABLE FOR PADLOCK  
 COMPATIBLE CON LUCCHETTO / COMPATÍVEL COM CADEADO:

(ref 10403226-27)

Ref	↔	📏	📦	📊
1040 3156	40/50 mm	1	1	1,45

LLAVE BRUTO CANDADO INOX 30MM / CLÉ BRUTE CADENAS INOX 30MM / 30MM S.S PADLOCK KEY BLANK  
 CHIAVE VUOTA PER LUCCHETTO INOX 30MM / CHAVE EM BRUTO PARA CADEADO INOX 30MM



COMPATIBLE CON CANDADO / COMPATIBLE AVEC LE CADENAS / SUITABLE FOR PADLOCK  
 COMPATIBLE CON LUCCHETTO / COMPATÍVEL COM CADEADO:

(ref 10403206-07)

Ref	↔	📏	📦	📊
1040 3157	30 mm	1	1	0,98

LLAVE BRUTO CANDADO INOX 40MM / CLÉ BRUTE CADENAS INOX 40MM / 40MM S.S PADLOCK KEY BLANK  
 CHIAVE VUOTA PER LUCCHETTO INOX 40MM / CHAVE EM BRUTO PARA CADEADO 40MM



COMPATIBLE CON CANDADO / COMPATIBLE AVEC LE CADENAS / SUITABLE FOR PADLOCK  
 COMPATIBLE CON LUCCHETTO / COMPATÍVEL COM CADEADO:

(ref 10403208-09)

Ref	↔	📏	📦	📊
1040 3158	40 mm	1	1	1,15

LLAVE BRUTO CANDADO 70/90MM / ÉBAUCHE DE CLÉ POUR CADENAS 70/90MM / 70/90MM PADLOCK KEY BLANK /  
 CHIAVE VUOTO PER LUCCHETTO 70/90MM / CHAVE EM BRUTO PARA CADEADO 70/90MM



COMPATIBLE CON CANDADO / COMPATIBLE AVEC LE CADENAS / SUITABLE FOR PADLOCK  
 COMPATIBLE CON LUCCHETTO / COMPATÍVEL COM CADEADO:

(ref 10403113-14)

Ref	↔	📏	📦	📊
10403159	70/90 mm	1	1	0,76

LLAVE BRUTO CANDADO INOX 50MM / CLÉ BRUTE CADENAS INOX 50MM / 50MM S.S PADLOCK KEY BLANK  
 CHIAVE VUOTA PER LUCCHETTO INOX 50MM / CHAVE EM BRUTO PARA CADEADO 50MM



COMPATIBLE CON CANDADO / COMPATIBLE AVEC LE CADENAS / SUITABLE FOR PADLOCK  
 COMPATIBLE CON LUCCHETTO / COMPATÍVEL COM CADEADO:

(ref 10403210)

Ref	↔	📏	📦	📊
10403160	50 mm	1	1	0,76



CANDADO COMBINACIÓN EQUIPAJE / CADENAS COMBINAISON BAGAGES / PADLOCK WITH LUGGAGE COMBINATION  
LUCCHETTO CON COMBINAZIONE / CADEADO COMBINAÇÃO BAGAGEM



ES Homologación TSA que permite el transporte de maletas con seguridad en EEUU y Canadá.  
FR Approbation TSA permettant le transport de bagages en toute sécurité aux États-Unis et au Canada.  
EN The TSA approval allows the safety transport of your luggage in the USA and Canada.  
IT L'approvazione TSA consente il trasporto dei bagagli con sicurezza in USA e Canada.  
PT Homologação TSA que permite o transporte de bagagem com segurança nos EUA e no Canadá.

Ref				
1040 3231	30 mm - 3 digits	12	9,93	✓
1040 3232	30 mm - 4 digits	12	10,49	✓

CANDADO COMBINACIÓN EQUIPAJE CON CABLE / CADENAS COMBINAISON BAGAGES CABLE / PADLOCK WITH WIRE AND LUGGAGE COMBINATION  
LUCCHETTO CON CAVO E COMBINAZIONE / CADEADO COMBINAÇÃO BAGAGEM CABO



ES Homologación TSA que permite el transporte de maletas con seguridad en EEUU y Canadá.  
FR Approbation TSA permettant le transport de bagages en toute sécurité aux États-Unis et au Canada.  
EN The TSA approval allows the safety transport of your luggage in the USA and Canada.  
IT L'approvazione TSA consente il trasporto dei bagagli con sicurezza in USA e Canada.  
PT Homologação TSA que permite o transporte de bagagem com segurança nos EUA e no Canadá.

Ref					
1040 3233	30 mm - 3 digits	1	12	10,76	✓

CAJAS DE SEGURIDAD / COFFRETS DE SÉCURITÉ / SAFE BOXES / CASSETTE DI SICUREZZA / COFRES DE SEGURANÇA

CAJA SEGURIDAD 2 LLAVES Y 2 CIERRES / COFFRET SÉCURITÉ 2 CLES/2 FERMETURES / SAFE 2 KEYS/2 LOCKING BOLTS  
CASSETTA DI SICUREZZA 2 CHIAVI/2 CHIUSURE / CAIXA DE SEGURANÇA 2 CHAVES/2 FECHOS

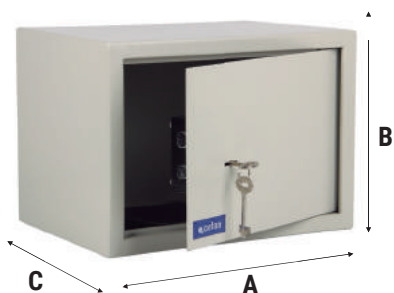

Ref	A	B	C			
1040 5010	350 mm	250 mm	250 mm	1	168,52	✓

CAJA SEGURIDAD CERRADURA ELECTRÓNICA / BOITIER SÉCURITÉ SERRURE ÉLECTRONIQUE / SAFE WITH ELECTRONIC LOCK  
CASSETTA DI SICUREZZA ELETTRONICA / CAIXA DE SEGURANÇA FECHADURA ELETRÔNICA

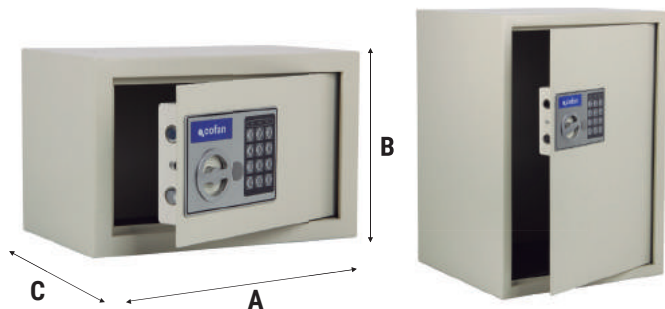

Ref	A	B	C			
1040 5011	310 mm	200 mm	200 mm	1	142,18	✓
1040 5012	350 mm	250 mm	250 mm	1	167,73	✓
1040 5013	360 mm	500 mm	330 mm	1	351,45	✓



BOCALLAVE ROSETA NIQUEL SATINADO / SERRURE SOCLE NICKEL SATINE / KEYHOLE ESCUTCHEON SATIN NICKEL  
 BOCCHETTA ROSETTA NICHEL SATINATO / FECHADURA INTERNA ROSETA NIQUEL SATINADO



**ZAMAK**  
**Ø 50 mm**

Ref				
<b>3140 1013</b>	Níquel / Nickel / Niquel / Nichel / Níquel	1	6	<b>5,12</b>

MULETILLA ROSETA CON DESBLOQUEO NIQUEL SATINADO / SERRURE A CONDAMNATION SOCLE AVEC DÉBLOCAGE NICKEL SATINE  
 THUMBTURN AND RELEASE ROSE SATIN NICKEL / NOTTOLINO ROSETTA PER SBLOCCARE NICHEL SATINATO  
 TRINCO ROSETA COM DESBLOQUEIO NIQUEL SATINADO

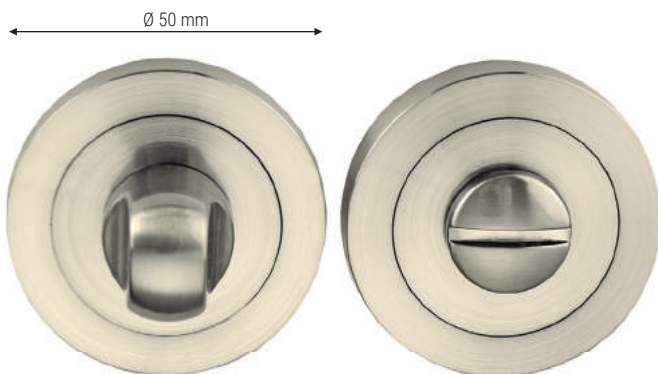

**ZAMAK**  
**Ø 50 mm**

Ref				
<b>3140 1014</b>	Níquel / Nickel / Niquel / Nichel / Níquel	1	6	<b>7,83</b>

POMO PUERTA ZAMAK CROMADO / POIGNEE BOULE PORTE ZAMAK CHROMÉ / CHROME ZAMAK DOOR KNOB  
 POMOLO PORTA ZAMAK CROMATO / PUXADOR PORTA ZAMAK CROMADO

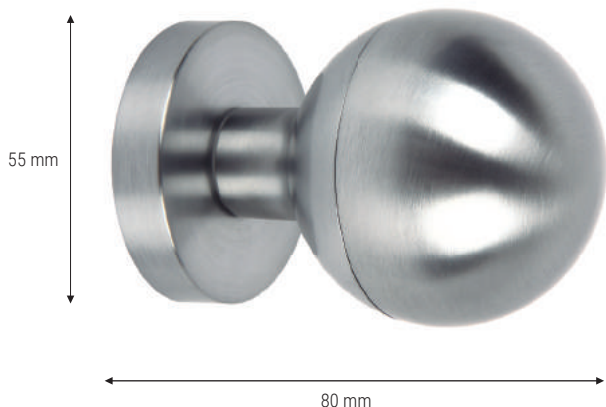

- ES Set 2 pomos + fijaciones
- FR Boîte à 2 poignées boule + fixations
- EN 2 door knob set + fixings
- IT Kit di 2 pomoli sfera + fissaggi
- PT Jogo de 2 puxador bola + parafusos fix

Set 2 pomos + fijaciones

Ref				
<b>3140 1015</b>	Cromado / Chromé / Chrome / Cromato / Cromado	1	20	<b>23,49</b>



JUEGO MANIVELA ROSETA REDONDA / JEU DE POIGNEES EN SOCLE ROND / DOOR HANDLE SET ROUND ROSE  
 KIT MANIGLIA ROSETTA ROTONDA / JOGO MANIVELA ROSETA REDONDA

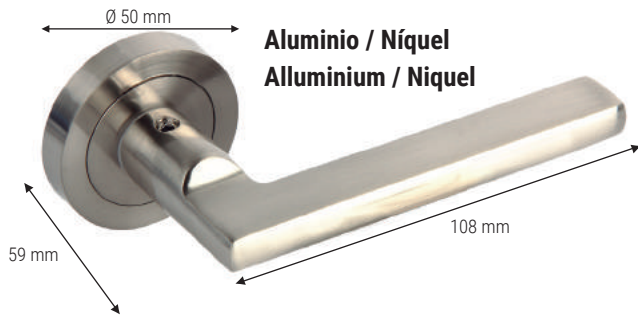

**Aluminio / Níquel**  
**Alluminium / Niquel**

**Mod. VIENA**

Set 2 manivelas + fijaciones  
 Boîte à 2 poignées de porte + fixations  
 2 door handle set + fixings  
 Kit di 2 maniglie + fissaggi  
 Jogo de 2 manivelas + parafusos fix

Ref					
3140 1001	Níquel / Nickel / Niquel / Nichel / Níquel	1	20		10,30

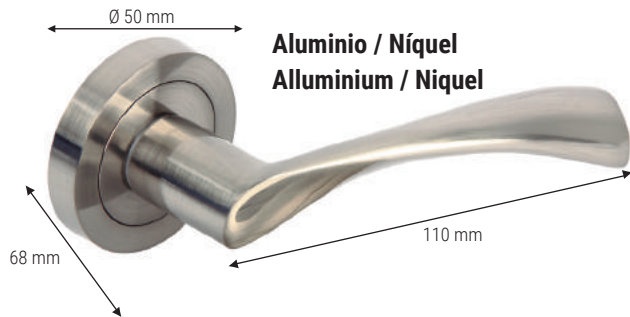

**Aluminio / Níquel**  
**Alluminium / Niquel**

**Mod. ROMA**

Set 2 manivelas + fijaciones  
 Boîte à 2 poignées de porte + fixations  
 2 door handle set + fixings  
 Kit di 2 maniglie + fissaggi  
 Jogo de 2 manivelas + parafusos fix

Ref					
3140 1002	Níquel / Nickel / Niquel / Nichel / Níquel	1	20		10,30



**Aluminio / Níquel**  
**Alluminium / Niquel**

**Mod. MOSCU**

Set 2 manivelas + fijaciones  
 Boîte à 2 poignées de porte + fixations  
 2 door handle set + fixings  
 Kit di 2 maniglie + fissaggi  
 Jogo de 2 manivelas + parafusos fix

Ref					
3140 1004	Níquel / Nickel / Niquel / Nichel / Níquel	1	20		10,66

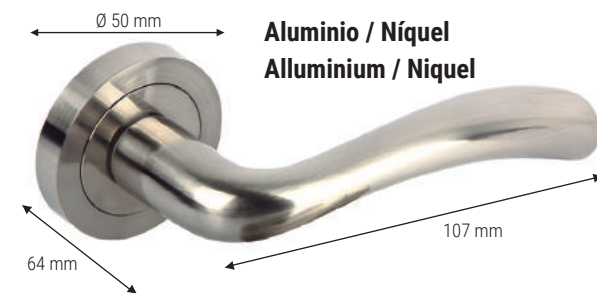

**Aluminio / Níquel**  
**Alluminium / Niquel**

**Mod. OSLO**

Set 2 manivelas + fijaciones  
 Boîte à 2 poignées de porte + fixations  
 2 door handle set + fixings  
 Kit di 2 maniglie + fissaggi  
 Jogo de 2 manivelas + parafusos fix

Ref					
3140 1005	Níquel / Nickel / Niquel / Nichel / Níquel	1	20		10,66

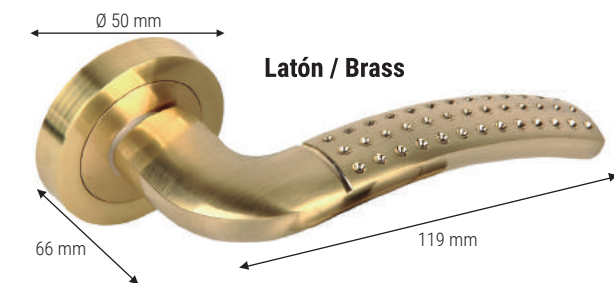

**Latón / Brass**

**Mod. LONDRES**

Set 2 manivelas + fijaciones  
 Boîte à 2 poignées de porte + fixations  
 2 door handle set + fixings  
 Kit di 2 maniglie + fissaggi  
 Jogo de 2 manivelas + parafusos fix

Ref					
3140 1007	Latón / Laiton / Brass / Ottone / Latao	1	20		10,95

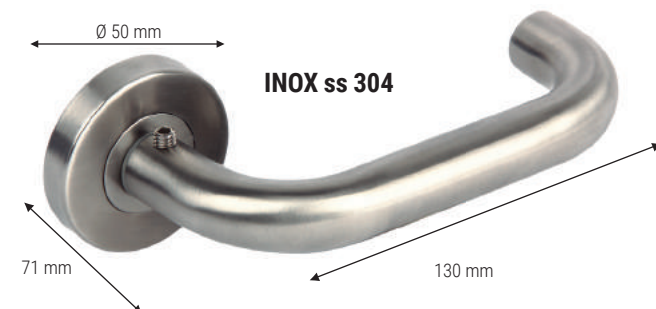

**INOX ss 304**

**Mod. PARIS**

Set 2 manivelas + fijaciones  
 Boîte à 2 poignées de porte + fixations  
 2 door handle set + fixings  
 Kit di 2 maniglie + fissaggi  
 Jogo de 2 manivelas + parafusos fix

Ref					
3140 1008	INOX	1	20		14,35





JUEGO MANIVELA ALUMINIO ROSETA CUADRADA NIQUEL / JEU DE POIGNEES EN ALUMINIUM SOCLE CARRE NICKEL  
ALUMINIUM DOOR HANDLE SET SQUARE NICKEL ROSE / KIT MANIGLIA ALLUMINIO ROSETTA QUADRATA NICHEL  
JOGO MANIVELA ALUMINIO ROSETA CUADRADA NIQUELADA



**Mod. BERLIN**

Set 2 manivelas + fijaciones  
Boîte à 2 poignées de porte + fixations  
2 door handle set + fixings  
Kit di 2 maniglie + fissaggi  
Jogo de 2 manivelas + parafusos fix

Ref					
3140 1006	Níquel / Nickel / Niquel / Nichel / Níquel	1	20	14,55	

JUEGO MANIVELA ZAMAK ROSETA REDONDA / JEU DE POIGNEES ZAMAK "PRAGUE" SOCLE ROND / ZAMAK DOOR HANDLE SET "PRAGA" ROUND ROSE  
KIT MANIGLIA ZAMAK "PRAGA" ROSETTA ROTONDA / JOGO MANIVELA ZAMAK "PRAGA" ROSETA REDONDA



**Mod. PRAGA**

Set 2 manivelas + fijaciones  
Boîte à 2 poignées de porte + fixations  
2 door handle set + fixings  
Kit di 2 maniglie + fissaggi  
Jogo de 2 manivelas + parafusos fix

Ref					
3140 1003	Latón / Laiton / Brass / Ottone / Latao	1	20	17,58	

**Mod. ATENAS**

Set 2 manivelas + fijaciones  
Boîte à 2 poignées de porte + fixations  
2 door handle set + fixings  
Kit di 2 maniglie + fissaggi  
Jogo de 2 manivelas + parafusos fix

Ref					
3140 1009	Níquel / Nickel / Niquel / Nichel / Níquel	1	20	16,95	

JUEGO MANIVELA CON PLACA ALU-ZAMAK / JEU DE POIGNEES AVEC PLAQUE ALU-ZAMAK / DOOR HANDLE SET WITH ALU-ZAMAK BACKPLATE  
KIT MANIGLIA CON PIASTRA ALU-ZAMAK / JOGO MANIVELA CON PLACA ALU-ZAMAK

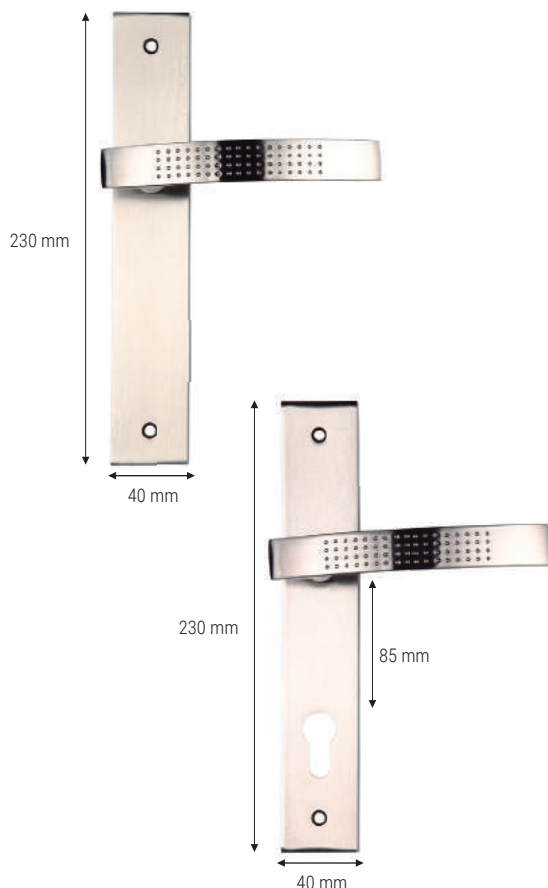

**Aluminio / ZAMAK**  
**Alluminium / ZAMAK**

Set 2 manivelas + fijaciones  
Boîte à 2 poignées de porte + fixations  
2 door handle set + fixings  
Kit di 2 maniglie + fissaggi  
Jogo de 2 manivelas + parafusos fix

Ref					
3140 1011	Níquel / Nickel / Niquel / Nichel / Níquel	1	20	16,90	

Con hendidura para cerradura / Avec fente serrure / With lock  
Con blocco bloccato / Con hendidura cerradura

Set 2 manivelas + fijaciones  
Boîte à 2 poignées de porte + fixations  
2 door handle set + fixings  
Kit di 2 maniglie + fissaggi  
Jogo de 2 manivelas + parafusos fix

Ref					
3140 1012	Níquel / Nickel / Niquel / Nichel / Níquel	1	20	16,90	



BUZÓN CORREO EXTERIOR / BOITE AUX LETTRES EXTERIEURE / OUTDOOR LETTER BOX  
CASSETTA POSTALE PER ESTERNO / CAIXA DE CORREIO EXTERIOR



**Mod. LETTER**

ES Incluye 2 llaves + Set anclaje. Apertura hacia abajo. Medida Boca 185 x 25 mm.

FR Inclut 2 clés + set d'ancrage. Overture placée vers le bas. Mesure de la fenêtre 185 x 25 mm.

EN Includes 2 keys & an anchor wall set. Downward door opening. Letter plate measurement 185 x 25 mm.

IT Includi 2 chiavi + set di ancoraggio. Apertura della porta verso il basso. Misurazione della buca 185 x 25 mm.

PT Inclue 2 chaves + set de ancoragem. Abertura para baixo. Medição de a boca 185 x 25 mm.

Ref				
<b>4100 7101B</b>	Blanco / Blanc / White / Bianco / Branco	1	10	<b>23,92</b>
<b>4100 7101N</b>	Negro / Noir / Black / Nero / Preto	1	10	<b>23,92</b>
<b>4100 7101V</b>	Verde / Vert / Green / Verde / Verde	1	10	<b>23,92</b>



**Mod. GARDEN**

ES Incluye 2 llaves + Set anclaje. Apertura hacia abajo. Medida Boca 160 x 30 mm.

FR Inclut 2 clés + set d'ancrage. Overture placée vers le bas. Mesure de la fenêtre 160 x 30 mm.

EN Includes 2 keys & an anchor wall set. Downward door opening. Letter plate measurement 160 x 30 mm.

IT Includi 2 chiavi + set di ancoraggio. Apertura della porta verso il basso. Misurazione della buca 160 x 30 mm.

PT Inclue 2 chaves + set de ancoragem. Abertura para baixo. Medição de a boca 160 x 30 mm.

Ref				
<b>4100 7102B</b>	Blanco / Blanc / White / Bianco / Branco	1	10	<b>28,08</b>
<b>4100 7102N</b>	Negro / Noir / Black / Nero / Preto	1	10	<b>28,08</b>
<b>4100 7102V</b>	Verde / Vert / Green / Verde / Verde	1	10	<b>28,08</b>



**Mod. POST**

ES Incluye 2 llaves + Set anclaje. Apertura lateral. Medida Boca 260 x 22 mm.

FR Inclut 2 clés + set d'ancrage. Overture latérale. Mesure de la fenêtre 260 x 22 mm.

EN Includes 2 keys & an anchor wall set. Side opening door. Letter plate measurement 260 x 22 mm.

IT Includi 2 chiavi + set di ancoraggio. Apertura laterale. Misurazione della buca 260 x 22 mm.

PT Inclue 2 chaves + set de ancoragem. Abertura lateral. Medição de a boca 260 x 22 mm.

Ref				
<b>4100 7103B</b>	Blanco / Blanc / White / Bianco / Branco	1	10	<b>30,68</b>
<b>4100 7103N</b>	Negro / Noir / Black / Nero / Preto	1	10	<b>30,68</b>
<b>4100 7103V</b>	Verde / Vert / Green / Verde / Verde	1	10	<b>30,68</b>



	ES	FR	EN	IT	PT
<b>Ref</b>	Referencia	Référence	Reference	Riferimento	Referência
	Colores	Couleur	Color	Colore	Cores
	Longitud	Longueur	Length	Lunghezza	Comprimento
	Precio	Prix	Price	Prezzo	Preço
	Descripción	Description	Description	Descrizione	Descrição
	Voltaje	Voltage	Voltage	Voltaggio	Voltagem
	Unidad mínima de venta	Nombre d'unités minimum de vente	Minimum sale unit	Quantitativo minimo di vendita	Unidade mínima de venda
	Packing	Conditionnement	Packing	Imballo	Embalagem
	Blister	Blister	Blister	Blister	Blister
<b>MODEL</b>	Modelo	Modèle	Model	Modello	Modelo





**cofan**



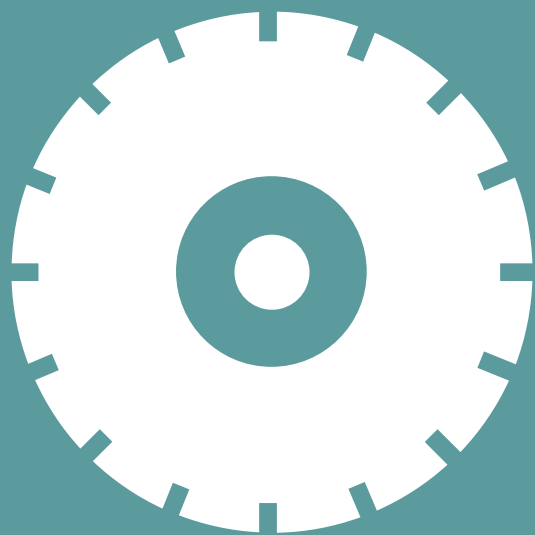



# ÍNDICE / INDEX / CONTENTS

## INDICE / ÍNDICE



**456**

DISCOS ABRASIVOS / DISQUES ABRASIFS  
ABRASIVE DISCS / DISCHI ABRASIVI  
DISCOS ABRASIVOS



**469**

BROCAS PARA ACERO / FORETS EN ACIER  
DRILLS FOR STEEL / PUNTE IN ACCIAIO  
BROCAS PARA AÇO



**460**

DISCOS LAMINADOS / DISQUES À LAMELLES  
FLAP DISCS / DISCHI LAMINATI  
DISCOS LAMINADOS



**478**

BROCAS CONSTRUCCIÓN  
FORETS DE CONSTRUCTION / BUILDING DRILLS  
PUNTE DA COSTRUZIONE / BROCA CONSTRUÇÃO



**461**

MUELAS ABRASIVAS / DISQUES MEULE  
ABRASIVE VITRIFIED DISCS / MOLI ABRASIVE  
MÓ ABRASIVA



**485**

BROCA PORCELÁNICO / FORET PORCELAINE  
DRILLS FOR PORCELAIN / PUNTE PER PORCELLANA  
BROCAS PARA PORCELANA



**462**

MATERIAL CORTE DE DIAMANTE  
MATERIEL COUPE DE DIAMANT  
DIAMOND CUTTING MATERIAL  
DISCHI DA TAGLIO DIAMANTATI  
MATERIAL DE CORTE DE DIAMANTE



**486**

BROCAS PARA MADERA / FORETS BOIS  
WOOD DRILLS / PUNTE PER LEGNO  
BROCAS PARA MADEIRA



**467**

LIJAS / PAPIER ABRASIF / SANDPAPERS  
CARTA ABRASIVA / LIXAS



**488**

BROCAS ESCALONADAS / FORETS FRAISEURS  
COUNTERSINK DRILLS / PUNTE SVASATRICI  
ESCAREADORES



**489**

BROCAS AVELLANADORAS / FORETS FRAISEURS  
COUNTERSINK DRILLS / PUNTE SVASATRICI  
ESCAREADORES



**503**

SIERRAS / SIE / SAW  
SEGHE / SERRAS



**489**

ACCESORIOS TALADRO / ACCESSOIRES FORETS  
DRILLS ACCESSORIES / ACCESSORI PER PUNTE  
ACESSÓRIOS BROCAS



**506**

SIERRAS DE CINTA / SCIE À RUBAN  
BAND SAW BLADES / SEGHE A NASTRO  
SERRAS DE FITA



**493**

MACHOS, TERRAJAS Y EXTRACTORES  
TARAUDS, FILIÈRES ET EXTRACTEURS  
TAPS, DIES AND EXTRACTORS  
MASCHI, FILIERE ED ESTRATTORI  
MACHOS, CAÇONETES E EXTRAÇÃO PARAFUSOS



**507**

CORONAS DE CONSTRUCCIÓN  
COURONNES DE CONSTRUCTION  
CONSTRUCTION HOLE SAWS  
CORONE DA COSTRUZIONE  
COROAS DE CONSTRUÇÃO



**495**

MACHOS DE MÁQUINA / TARAUDS MACHINE  
MACHINE TAPS / MASCHI DA MACCHINA  
MACHOS DE MÁQUINA



**510**

FRESAS ROTATIVAS / RAISES ROTATIVES  
STRAIGHT SHANK ROTARIES / FRESE ROTATIVE  
FRESAS ROTATIVAS



**498**

PUNZÓN TALADRO ELECTROMAGNÉTICO  
POINÇON POUR PERCEUSE ÉLECTROMAGNÉTIQUE  
PILOT PIN FOR ELECTROMAGNETIC DRILL  
PUNZONE TRAPANO ELETTRMAGNETICO  
PUNÇÃO BERBEQUIM ELETROMAGNÉTICO



**515**

ABRASIVO / ABRASIF / ABRASIVE  
ABRASIVO / ABRASIVO



**499**

CORONAS DE METAL / COURONNES DE MÉTAL  
METAL HOLE SAWS / CORONE IN METALLO  
COROAS DE METAL



**518**

GLOSARIO / GLASSAIRE / GLOSSARY  
GLOSSARIO / GLOSSÁRIO



ES Discos de corte y desbaste para rectificadora angular. Productos fabricados según la normativa vigente CEE (EN 12413), FEPA. Certificado según la norma UNI ISO 9001:2000. Desde el año 2008 "oSa®" (Organización para la Seguridad de los Abrasivos).

FR Disques de coupe et de taille angulaire fabriqués selon la réglementation CEE (12413) FEPA. Certifiés selon la norme ISO 9001:2000. Depuis 2008 "oSa®" (Organisation pour la Sécurité des Abrasifs).

EN Cutting and rough-hewing discs comply with the requirements of EEC (12413), FEPA, they are certificated according to its norm UNI ISO 9001:2000, "entity rina" and from the year 2008 "oSa®" (Organization for the Safety of Abrasives).

IT I nostri dischi da taglio e levigatura sono costruiti secondo la normativa vigente CEE (12413), FEPA. Siamo certificati secondo la norma UNI ISO 9001:2000, "ente rina". Dal 1° maggio 2008 "oSa®" (Organizzazione per la Sicurezza degli Abrasivi).

PT Discos de corte e desbaste em conformidade com as exigências da CEE (12413), FEPA, que são certificados de acordo com a norma UNI ISO 9001:2000, "Entidade rina" e do ano 2008 "oSa®" (Organização para a Segurança dos Abrasivos).

GAMA PROFESIONAL / GAMME PROFESSIONNELLE / PROFESSIONAL LINE / GAMMA PROFESSIONALE / GAMA PROFISSIONAL

+ 30% Rendimiento

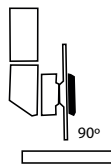

ES +30% seguridad y rendimiento. ACERO/HIERRO - Sólo corte.

FR +30% Sécurité et les performances. ACIER/FER - Coupe uniquement.

EN +30% Safety and efficiency. STEEL/IRON - Only cutting.

IT +30% Sicurezza e rendimento. ACCIAIO/FERRO - Solo taglio.

PT +30% Segurança e rendimento. AÇO/FERRO - Apenas corte.

Ref	厚	Ø				
1001 1125	2,5 x 22,2 mm	125 mm		1	50	1,70
1001 1230	2,5 x 22,2 mm	230 mm		1	25	3,44
1001 0115	3,0 x 22,2 mm	115 mm		1	50	1,29
1001 0125	3,0 x 22,2 mm	125 mm		1	50	1,85
1001 0180	3,0 x 22,2 mm	180 mm		1	25	2,61
1001 0230	3,0 x 22,2 mm	230 mm		1	25	3,16
1001 0300	3,5 x 22,2 mm	300 mm		1	10	6,62
1001 1300	3,5 x 25,4 mm	300 mm		1	10	6,62

GAMA ESTÁNDAR "LÍNEA AZUL" / GAMME BLEUE STANDARD / STANDARD LINE "BLUE LINE"  
GAMA STANDARD "LINEA AZZURRA" / GAMA STANDARD "LINHA AZUL"

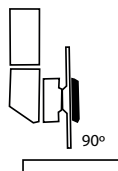

ES ACERO/HIERRO - Sólo corte.

FR ACIER/FER - Coupe uniquement.

EN STEEL/IRON - Only cutting.

IT ACCIAIO/FERRO - Solo taglio.

PT AÇO/FERRO - Apenas corte.

Ref	厚	Ø				
1001 2115	3,0 x 22,2 mm	115 mm		1	50	1,22
1001 2230	3,0 x 22,2 mm	230 mm		1	25	2,93

GAMA PROFESIONAL / GAMME PROFESSIONNELLE / PROFESSIONAL LINE / GAMMA PROFESSIONALE / GAMA PROFISSIONAL

+ 30% Rendimiento

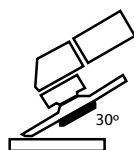

ES +30% seguridad y rendimiento. ACERO/HIERRO - Desbaste.

FR +30% Sécurité et les performances. ACIER/FER - Taille.

EN +30% Safety and efficiency. STEEL/IRON - Rough-hewing.

IT +30% Sicurezza e rendimento. ACCIAIO/FERRO - Levigatura.

PT +30% Segurança e rendimento. AÇO/FERRO - Desbaste.

Ref	厚	Ø				
1002 0115	7,0 x 22,2 mm	115 mm		1	25	2,30
1002 0125	7,0 x 22,2 mm	125 mm		1	25	3,00
1002 0180	7,0 x 22,2 mm	180 mm		1	10	4,50
1002 0230	7,0 x 22,2 mm	230 mm		1	10	6,48



DISCOS DE CORTE 4 X 4 / DISQUES DE COUPE 4 X 4 / 4 X 4 CUTTING DISCS / DISCO DA TAGLIO 4 X 4 / DISCO DE CORTE 4 X 4

UNIVERSAL

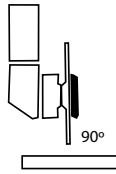

ES Sólo corte. REVOLUCIONARIO DISCO DE CORTE 4 x 4. Disco de corte de aplicación universal, adecuado tanto para materiales férricos (hierro, acero, aluminio, etc.), como para materiales no férricos (plástico, madera, PVC, cemento, azulejos, piedra, etc.).

FR Coupe uniquement. UN DISQUE RÉVOLUTIONNAIRE DE COUPE 4 x 4. Disque de coupe d'application universelle, adapté aussi bien pour les métaux (fer, acier, aluminium, etc...) que pour le plastique, le bois, PVC, ciment, carrelage, pierre, etc...

EN Only cutting. REVOLUTIONARY CUTTING DISC 4 x 4. Universal application disc. It can be used with ferric materials (Iron, steel, aluminium, etc...), as well as non-ferric (plastic, wood, PVC, concrete, tile, stone, etc...).

IT Solo taglio. RIVOLUZIONARIO DISCO DA TAGLIO 4 x 4. Disco da taglio per applicazione universale, adatto sia per materiali metallici (ferro, acciaio, alluminio, etc...), che per materiali non metallici (plastica, legno, PVC, cemento, ceramica, pietra, etc...).

PT Apenas corte. REVOLUCIONÁRIO DISCO DE CORTE 4 x 4. Disco de corte de aplicação universal. Pode ser usado com materiais férricos (ferro, aço, alumínio, etc. ...), bem como não-férricos (de plástico, de madeira, de PVC, de cimento, azulejos, pedra, etc. ...).

Ref	■	∅	●	■	⊞	⊞
1006 0115	2,5 x 22,2 mm	115 mm	22,2 mm	1	50	<b>2,35</b>
1006 0125	2,5 x 22,2 mm	125 mm	22,2 mm	1	50	<b>2,57</b>
1006 0230	2,5 x 22,2 mm	230 mm	22,2 mm	1	25	<b>4,80</b>

DISCOS DE CARBURO SILICIO PARA PIEDRA / DISQUE EN CARBURE DE SILICIUM POUR LA PIERRE / CUTTING DISC FOR STONE  
DISCHI AL CARBURO DI SILICIO PER PIETRA / DISCO DE CORTE PARA PEDRA

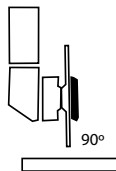

ES PIEDRA - Sólo corte.

FR MATERIAUX - Coupe uniquement.

EN STONE - Only cutting.

IT PIETRA - Solo taglio.

PT PEDRA - Apenas corte.

Ref	■	∅	■	⊞	⊞
1005 1115	1,6 x 22,2 mm	115 mm	1	100	<b>2,45</b>
1005 2230	1,9 x 22,2 mm	230 mm	1	25	<b>4,95</b>
1005 2115	2,5 x 22,2 mm	115 mm	1	50	<b>1,53</b>
1005 0125	2,5 x 22,2 mm	125 mm	1	50	<b>1,82</b>
1005 1230	2,5 x 22,2 mm	230 mm	1	25	<b>3,56</b>
1005 0115	3,0 x 22,2 mm	115 mm	1	50	<b>1,53</b>
1005 0230	3,0 x 22,2 mm	230 mm	1	25	<b>3,56</b>

DISPLAY DISCO ABRASIVO / PRESENTOIR DISQUES ABRASIFS / ABRASIVE DISCS DISPLAY STAND  
ESPOSITORE DISCHI ABRASIVI / EXPOSITOR DISCOS ABRASIVOS



ES Discos no incluidos.

FR Disques non compris.

EN Discs are not included.

IT Dischi non inclusi.

PT Discos não incluídos.

Ref	⊞	⊞	⊞
EXPOSITOR 16	370 x 460 mm	1	<b>104,00</b>





ES Discos de corte para acero y acero inoxidable. Corte de aceros inoxidables, aceros aleados y hierros fundidos duros. Excelente velocidad de corte y amplia duración.

FR Disque de coupe pour acier et acier inoxydable. Coupe acier INOX, alliage, fer, dur. Excellente vitesse de coupe et longue durée.

EN Stainless steel and steel cutting discs. Stainless steel, alloyed steel and cast-iron. Excellent cutting speed and long-life service.

IT Dischi da taglio per acciaio ed INOX. Acciai legati, fusioni in ferro. Eccellente velocità di taglio e lunga durata.

PT Discos de corte para aço inoxidável e aço. Corte de aço inoxidável, ligas de aço e ferro fundido. Velocidade de corte e excelente serviço de longa duração.

GAMA ACERO Y ACERO INOXIDABLE "LÍNEA GRIS" / GAMME ACIER INOXYDABLE "LIGNE GRISE"  
STAINLESS STEEL LINE "GREY LINE" / GAMMA ACCIAIO INOX "LINEA GRIGIA" / GAMA AÇO E AÇO INOXIDÁVEL "LINHA CINZA"

+ 30% Rendimiento

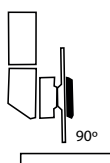

ES +30% seguridad y rendimiento. ACERO/ACERO INOX - Sólo corte.

FR +30% Sécurité et les performances. ACIER/ACIER INOXYDABLE - Coupe uniquement.

EN +30% Safety and efficiency. STEEL/STAINLESS STEEL - Only cutting.

IT +30% Sicurezza e rendimento. ACCIAIO/ACCIAIO INOX - Solo taglio.

PT +30% Segurança e rendimento. AÇO/AÇO INOXIDÁVEL - Apenas corte.



Ref	Thickness	Ø	Profile	Grid	Box	Stack	Price
1004 0115	1,6 x 22,2 mm	115 mm	▬	1	100		1,95
1004 0125	1,6 x 22,2 mm	125 mm	▬	1	100		2,15
1004 0230	1,9 x 22,2 mm	230 mm	▬	1	25		4,19
1003 0115	2,0 x 22,2 mm	115 mm	▬	1	50		1,62
1003 0125	2,0 x 22,2 mm	125 mm	▬	1	50		1,89
1003 0180	2,5 x 22,2 mm	180 mm	▬	1	25		2,61
1003 0230	2,5 x 22,2 mm	230 mm	▬	1	25		3,56

+ 30% Rendimiento

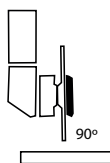

Ref	Thickness	Ø	Profile	Grid	Box	Stack	Price
1004 1115	1,0 x 22,2 mm	115 mm	▬	1	25		1,44
1004 1125	1,0 x 22,2 mm	125 mm	▬	1	25		1,85

GAMA ESTÁNDAR "LÍNEA AZUL" / GAMME BLEUE STANDARD / STANDARD LINE "BLUE LINE"  
GAMMA STANDARD "LINEA AZZURRA" / GAMA STANDARD "LINHA AZUL"

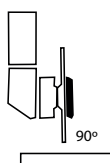

ES ACERO/ACERO INOX - Sólo corte.

FR ACIER/ACIER INOXYDABLE - Coupe uniquement.

EN STEEL/STAINLESS STEEL - Only cutting.

IT ACCIAIO/ACCIAIO INOX - Solo taglio.

PT AÇO/AÇO INOXIDÁVEL - Apenas corte.



Ref	Thickness	Ø	Profile	Grid	Box	Stack	Price
1004 2115	1,0 x 22,2 mm	115 mm	▬	1	25		1,20



DISCOS VULCANIZADOS PARA MÁQUINAS PORTÁTILES / DISQUES VULCANISÉS POUR MACHINES PORTABLES / FIBRE DISCS  
DISCHI IN FIBRA VULCANIZZATA PER MACCHINE PORTATILI / DISCOS DE FIBRA VULCANIZADA



ES DISCOS DE FIBRA: Discos de fibra vulcanizados de 0,8 mm de grosor. Gran dispersión de óxido de aluminio. Agujero central de 22 mm. Permite el lijado de grandes superficies.

- Granos de 16 a 40: Lijado de óxido, elimina hilos de soldaduras y alambres, lijado de cantos.
- Granos de 36 a 80: Lijado de piezas bañadas en algún material o lijado fino.
- Granos de 50 a 120: Lijado de carrocerías, limpieza de superficies metálicas y lijado de viejas capas lacadas.

FR DISQUES DE FIBRE: Vulcanisés de 0,8mm d'épaisseur. Grande dispersion d'oxyde d'aluminium. Permet le ponçage sur de grandes surfaces. Grande durabilité. Ponçage uniforme.

- Grains de 16 à 40: Ponçage oxyde, élimine les fils de soudure et fils de fer, ponçage des extrémités.
- Grains de 36 à 80: Ponçage de pièces trempées dans n'importe quel matériel, ou ponçage fin.
- Grains de 50 à 120: Ponçage de carrosserie, nettoyage de surface métalliques, ponçage de pièces anciennes laquées.

EN FIBRE DISCS: Vulcanised fibre discs 0,8mm thick. 22mm central hole. Long-life service. Regular sanding, easy changing over. Grain range for different applications.

- Grains from 16 to 40: to sand oxide, eliminate welding and wire threads and emery edges
- Grains from 36 to 80: to sand varnished parts or fine sanding
- Grains from 50 to 120: to sand body parts, clean metallic surfaces and sand old coats of painting.

IT DISCHI IN FIBRA: Dischi in fibra vulcanizzata di 0,8 mm di spessore, foro centrale di 22 mm. Permette la lavorazione di grandi superfici. Facili da cambiare. Di lunga durata.

- Grani da 16 a 40: carteggiatura ossidi, elimina fili e cavi di saldatura.
- Grani da 36 a 80: carteggiatura di materiale verniciato o materiale fino.
- Grani da 50 a 120: carteggiatura di carrozzerie, pulizia superfici metalliche, carteggiatura di vecchi strati laccati.

PT DISCOS DE FIBRA: Discos de fibra vulcanizada de 0,8 mm de grossura. Grande dispersão de óxido de alumínio. Buraco central de 22 mm. Permite o lixamento de grandes superfícies.

- Grãos de 16 a 40: Lixação de óxido, eliminar fios de soldagem, arames e arestas.
- Grãos de 36 a 80: Lixação de peças envernizada ou banhadas em outro material de lixação fina
- Grãos de 50 a 120: Lixação de carroçarias, limpeza de superfícies metálicas, de velhas capas pintadas.

Ref	Ø	MODEL			
<b>1008 11524</b>	115 mm	G-24	1	25	<b>1,04</b>
<b>1008 11536</b>	115 mm	G-36	1	25	<b>1,04</b>
<b>1008 11540</b>	115 mm	G-40	1	25	<b>1,04</b>
<b>1008 11550</b>	115 mm	G-50	1	25	<b>1,04</b>
<b>1008 11560</b>	115 mm	G-60	1	25	<b>1,04</b>
<b>1008 11580</b>	115 mm	G-80	1	25	<b>1,04</b>
<b>1008 115120</b>	115 mm	G-120	1	25	<b>1,04</b>
<b>1008 18016</b>	178 mm	G-16	1	25	<b>1,72</b>
<b>1008 18024</b>	178 mm	G-24	1	25	<b>1,72</b>
<b>1008 18036</b>	178 mm	G-36	1	25	<b>1,72</b>
<b>1008 18050</b>	178 mm	G-50	1	25	<b>1,72</b>
<b>1008 18060</b>	178 mm	G-60	1	25	<b>1,72</b>
<b>1008 18080</b>	178 mm	G-80	1	25	<b>1,72</b>
<b>1008 180120</b>	178 mm	G-120	1	25	<b>1,72</b>



DISCOS LAMINADOS / DISQUES À LAMELLES / FLAP DISCS / DISCHI LAMINATI / DISCOS LAMINADOS

**ESTÁNDAR**

ES Disco laminado de zirconio con plato soporte cóncavo, alto poder de desbaste y larga duración. Con granos desde 60 hasta 120. Válido para trabajar en aceros y aceros inoxidables.  
FR Disque laminé en zirconium avec plaque de support concave, fort pouvoir de dégrossissage et longue durée. Grains de 60 à 120. Valide pour travailler aciers et inox.  
EN Zirconium laminated disc with concave support plate, high power of roughing and long-lasting. Gritting from 60 to 120. Valid for work with steels and stainless steels.  
IT Disco laminato in zirconio con piatto di supporto concavo, ad alto potere di sgrossatura e di lunga durata. Con grani da 60 a 120. Ideale per lavorare l'acciaio e l'inox.  
PT Disco de zircônio laminado c/ placa de suporte côncava, desbaste de alta potência e longa duração. Com grãos desde 60 até 120. Válido para o trabalho em aços e aços inoxidáveis.

**INCLINADO ESTÁNDAR**



Ref	Ø	MODEL			
1031 11560	115 mm	G - 60	5	50	<b>2,60</b>
1031 11580	115 mm	G - 80	5	50	<b>2,60</b>
1031 115120	115 mm	G - 120	5	50	<b>2,60</b>

**PLANO ESTÁNDAR**



Ref	Ø	MODEL			
1032 11560	115 mm	G - 60	5	50	<b>2,60</b>
1032 11580	115 mm	G - 80	5	50	<b>2,60</b>
1032 115120	115 mm	G - 120	5	50	<b>2,60</b>

**PROFESIONAL**

ES Tipo "Z" (zirconium). Línea profesional para uso industrial. Disco laminado de gran rendimiento. Número de láminas desde 60 (grano grueso) hasta 120 (grano fino). Válido para trabajar acero o acero inoxidable.  
FR Type "Z" (zirconium). Gamme professionnelle de grande qualité, de type industriel pour utilisateurs professionnels. Disque avec tissu abrasif de haute performance. Grains de 60 (gros grain) à 120 (grain fin). Idéal pour acier et INOX.  
EN "Z" type (zirconium). Professional line discs of high quality, industrial type with abrasive cloth of high performance. The number of flaps: from 60 (coarse grit) to 120 (fine grit). They are suitable for work with steel and stainless steel.  
IT Tipo "Z" (zirconium). Línea professionale di grande qualità, di tipo industriale con utilizzo professionale. Il numero delle lamine va da 60 (grano grosso) a 120 (grano fine). Ideale per lavorare l'acciaio e l'inox.  
PT Tipo "Z" (zirconium). Linha profissional para uso industrial. Disco laminado de grande rendimento. Número de lâminas desde 60 (grão grosso) até 120 (grão fino). Ideal para trabalhar com aço e aço inoxidável.

**INCLINADO PROFESIONAL**



Ref	Ø	MODEL			
1007 11560	115 mm	G - 60	1	20	<b>4,95</b>
1007 11580	115 mm	G - 80	1	20	<b>4,95</b>
1007 115120	115 mm	G - 120	1	20	<b>4,95</b>
1007 12560	125 mm	G - 60	1	20	<b>5,04</b>
1007 12580	125 mm	G - 80	1	20	<b>5,04</b>
1007 125120	125 mm	G - 120	1	20	<b>5,04</b>
1007 17860	178 mm	G - 60	1	10	<b>9,90</b>
1007 17880	178 mm	G - 80	1	10	<b>9,90</b>
1007 178120	178 mm	G - 120	1	10	<b>9,90</b>

**PLANO PROFESIONAL**

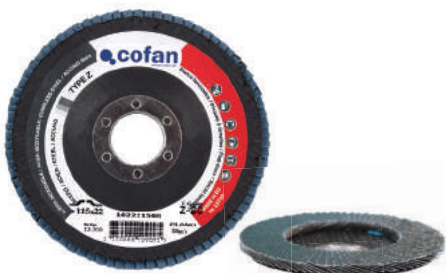

Ref	Ø	MODEL			
1022 11560	115 mm	G - 60	1	20	<b>4,28</b>
1022 11580	115 mm	G - 80	1	20	<b>4,28</b>
1022 115120	115 mm	G - 120	1	20	<b>4,28</b>
1022 12560	125 mm	G - 60	1	20	<b>5,04</b>
1022 12580	125 mm	G - 80	1	20	<b>5,04</b>
1022 125120	125 mm	G - 120	1	20	<b>5,04</b>



MUELAS ABRASIVAS PARA ESMERILADORAS / DISQUES MEULE / ABRASIVE GRINDING WHEELS FOR SANDING TOOLS  
MOLI ABRASIVE PER SMERIGLIATRICI / MÓS ABRASIVAS PARA ESMERILADORES



Ref	■	∅	⊙	MODEL	📦	📦
1020 1001	16 mm	125 mm	32 mm	G-36	1	12,26
1020 1002	20 mm	125 mm	32 mm	G-36	1	13,02
1020 1003	16 mm	150 mm	32 mm	G-36	1	14,96
1020 1004	20 mm	150 mm	32 mm	G-36	1	16,28
1020 1005	20 mm	180 mm	32 mm	G-36	1	19,42
1020 1006	25 mm	180 mm	32 mm	G-36	1	22,90
1020 1007	20 mm	200 mm	32 mm	G-36	1	23,50
1020 1008	25 mm	200 mm	32 mm	G-36	1	27,35
1020 1009	30 mm	200 mm	32 mm	G-36	1	31,40
1020 1010	25 mm	250 mm	25 mm	G-36	1	45,75
1020 1011	30 mm	250 mm	25 mm	G-36	1	53,30
1020 1012	16 mm	125 mm	32 mm	G-60	1	12,26
1020 1013	20 mm	125 mm	32 mm	G-60	1	13,02
1020 1014	16 mm	150 mm	32 mm	G-60	1	14,96
1020 1015	20 mm	150 mm	32 mm	G-60	1	16,28
1020 1016	20 mm	180 mm	32 mm	G-60	1	19,42
1020 1017	25 mm	180 mm	32 mm	G-60	1	22,90
1020 1018	20 mm	200 mm	32 mm	G-60	1	23,50
1020 1019	25 mm	200 mm	32 mm	G-60	1	27,35
1020 1020	30 mm	200 mm	32 mm	G-60	1	31,40
1020 1021	25 mm	250 mm	25 mm	G-60	1	45,75
1020 1022	30 mm	250 mm	25 mm	G-60	1	53,30
1020 1023	16 mm	125 mm	32 mm	G-80	1	12,26
1020 1024	20 mm	125 mm	32 mm	G-80	1	13,02
1020 1025	16 mm	150 mm	32 mm	G-80	1	14,96
1020 1026	20 mm	150 mm	32 mm	G-80	1	16,28
1020 1027	20 mm	180 mm	32 mm	G-80	1	19,42
1020 1028	25 mm	180 mm	32 mm	G-80	1	22,90
1020 1029	20 mm	200 mm	32 mm	G-80	1	23,50
1020 1030	25 mm	200 mm	32 mm	G-80	1	27,35
1020 1031	30 mm	200 mm	32 mm	G-80	1	31,40
1020 1032	25 mm	250 mm	25 mm	G-80	1	45,75
1020 1033	30 mm	250 mm	25 mm	G-80	1	53,30

ES Muelas rectificadas grises, apropiadas para acero de construcción, acero aleado, así como para fundición gris. Velocidad máxima 33 m/s.

FR Disque meule gris, pour acier de construction, alliage. Vitesse maximum: 33 m/s.

EN Rectified gray millstones adapted for construction and alloyed steel. Max speed: 33 m/s.

IT Moli grigie rettificata. Adatte per acciai da carpenteria, acciai legati, ghise grigie. Velocità massima di uso: 33 m/s.

PT Mós retificadas cinzentas, próprias para aço de construção, ligas de aço e ferro fundido. Velocidade máxima 33 m/s.

MUELAS RECTIFICADAS BLANCAS DE ALTA CALIDAD, PARA EL TRABAJO EN ACERO DE ALTA ALEACIÓN, HSS Y ACEROS PARA HERRAMIENTAS  
DISQUES DE MEULE BLANCS DE HAUTE QUALITÉ, POUR LE TRAVAIL DE L'ACIER ALLIAGE RENFORCE, HSS ET ACIERS POUR OUTILS  
RECTIFIED HIGH QUALITY WHITE MILLSTONES FOR WORK WITH ALLOY STEEL, HSS STEEL AND TOOL STEEL  
MOLI BIANCHE RETTIFICATE, AD ALTA QUALITA'. ADATTO PER LA LAVORAZIONE DI ACCIAI FORTEMENTE LEGATI ED ATTREZZATURE IN ACCIAIO  
MÓS RETIFICADAS BRANCAS DE ALTA QUALIDADE, PARA LIGAS DE AÇO, HSS E AÇOS PARA FERRAMENTAS



ES Muelas rectificadas blancas, apropiadas para acero de construcción, aceros aleados, así como para fundición gris. Velocidad máxima 33 m/s.

FR Disques de meule blancs pour acier de construction, acier alliage, et pour fondations. Vitesse maximum: 33 m/s.

EN Rectified white millstones adapted for construction, alloy steel and also cast iron. Max speed: 33 m/s.

IT Moli bianche rettificata, adatte per acciai da costruzione, acciai legati e ghise grigie. Velocità massima di uso: 33 m/s.

PT Mós retificadas brancas, próprias para aço de construção, ligas de aço e ferro fundido. Velocidade máxima 33 m/s.

Ref	■	∅	⊙	MODEL	📦	📦
1020 2001	16 mm	150 mm	32 mm	G-60	1	21,35
1020 2002	20 mm	180 mm	32 mm	G-60	1	28,02
1020 2003	20 mm	200 mm	32 mm	G-60	1	34,08
1020 2004	25 mm	200 mm	32 mm	G-60	1	39,80
1020 2005	25 mm	250 mm	25 mm	G-60	1	67,50
1020 2006	16 mm	150 mm	32 mm	G-80	1	21,35
1020 2007	20 mm	180 mm	32 mm	G-80	1	28,02
1020 2008	20 mm	200 mm	32 mm	G-80	1	34,08
1020 2009	25 mm	200 mm	32 mm	G-80	1	39,80
1020 2010	25 mm	250 mm	25 mm	G-80	1	67,50

REDUCCIONES DE PLÁSTICO / RÉDUCTIONS PLASTIQUES / PLASTIC FITTINGS / RIDUZIONI IN PLASTICA / REDUTORES DE PLÁSTICO



PACK 2 UNID.

Ref	📦	📦	📦 x pack
1020 9997	32 x 13 mm	1 pack	0,98
1020 9998	32 x 16 mm	1 pack	0,98
1020 9999	32 x 20 mm	1 pack	0,98
1021 0000	32 x 25 mm	1 pack	0,98
1021 0001	25 x 20 mm	1 pack	0,98





DISCOS DE DIAMANTE "GENERAL DE OBRA" UNIVERSAL BASE / DISQUES DE DIAMANT "GENERAL CONSTRUCTION" BASE UNIVERSELLE  
DIAMOND DISCS "BUILDING WORK, GENERALLY" UNIVERSAL BASE / DISCHI DIAMANTATI UNIVERSALI "LAVORI EDILI"  
DISCOS DE DIAMANTE "GERAL DE CONSTRUÇÃO" BASE UNIVERSAL

**SEGMENTADO**



Ref	Ø	⊙	⊚	📦	📊	📄
1009 0115	115 mm	22,2 mm	7 mm	1	7,67	✓
1009 0125	125 mm	22,2 mm	7 mm	1	13,33	✓
1009 0230	230 mm	22,2 mm	7 mm	1	28,50	✓

ES Disco corte universal construcción, estándar.  
FR Disque de coupe universelle construction, standard.  
EN Universal cutting disc for construction, standard.  
IT Disco da taglio universale, standard e per edilizia.  
PT Disco de corte universal construção, standard.

**TURBO**



Ref	Ø	⊙	⊚	📦	📊	📄
1010 0115	115 mm	22,2 mm	7 mm	1	19,42	✓
1010 0125	125 mm	22,2 mm	7 mm	1	21,45	✓
1010 0230	230 mm	22,2 mm	7 mm	1	45,68	✓

ES Disco corte universal construcción, estándar.  
FR Disque de coupe universelle construction, standard.  
EN Universal cutting disc for construction, standard.  
IT Disco da taglio universale, standard e per edilizia.  
PT Disco de corte universal construção, standard.

**LÁSER PROFESIONAL**



Ref	Ø	⊙	⊚	📦	📊	📄
1011 0115	115 mm	22,2 mm	7 mm	1	27,30	✓
1011 0125	125 mm	22,2 mm	7 mm	1	36,12	✓
1011 0230	230 mm	22,2 mm	7 mm	1	68,04	✓
1016 0300	300 mm	25,4 mm	7 mm	1	165,20	✓
1016 0350	350 mm	25,4 mm	7 mm	1	247,80	✓

ES Disco para todo tipo de materiales de obra, profesional.  
FR Disque pour tout type de matériaux de construction, professionnel.  
EN Disc for all type of construction materials, professional.  
IT Disco per tutti i tipi di materiali da lavoro, professionale.  
PT Disco para todos os tipos de materiais de construção, profissional.

**TURBO PROFESIONAL**



Ref	Ø	⊙	⊚	📦	📊	📄
1014 0115	115 mm	22,2 mm	7 mm	1	25,70	✓
1014 0125	125 mm	22,2 mm	7 mm	1	29,90	✓
1014 0230	230 mm	22,2 mm	7 mm	1	67,50	✓

ES Uso general de obra. Profesional.  
FR Utilisation générale pour travail. Professionnels.  
EN General use for construction. Professional.  
IT Per lavori generici. Professionale.  
PT Uso geral na construção. Profissional.

DISCOS DE DIAMANTE "UNIVERSAL LARGA VIDA ÚTIL" PROFESIONAL / DISQUES DE DIAMANT "UNIVERSEL LONGUE DUREE" PROFESSIONNEL  
DIAMOND DISCS "UNIVERSAL LONG LIFE" PROFESSIONAL / DISCHI DIAMANTATI PROFESSIONALI "USO UNIVERSALE E DI LUNGA DURATA" DISCOS DE DIAMANTE "UNIVERSAL LONGA VIDA" PROFISSIONAL

**LÁSER**



Ref	Ø	⊙	⊚	📦	📊	📄
1017 0115	115 mm	22,2 mm	7 mm	1	40,32	✓
1017 0125	125 mm	22,2 mm	7 mm	1	49,98	✓
1017 0230	230 mm	22,2 mm	7 mm	1	106,90	✓
1017 0300	300 mm	25,4 mm	7 mm	1	201,60	✓

ES Disco profesional refrigerado larga vida útil. Excelente corte en seco o húmedo.  
FR Disque diamant "professionnel réfrigéré". Excellente coupe sec et eau.  
EN Diamond cutting discs professional refrigerated. Excellent for wet or dry cut.  
IT Disco diamantato professionale, refrigerato. Eccellente taglio umido e secco.  
PT Disco Profissional refrigerado vida longa. Excelente corte a seco ou molhado.





DISCO DIAMANTE CANTERO ESTÁNDAR / DISQUES DE DIAMANT BASE UNIVERSELLE / UNIVERSAL DIAMOND DISC  
DISCHI DIAMANTATI UNIVERSALI / DISCO DIAMANTADO UNIVERSAL BASIC

LÁSER



ES Disco corte universal construcción, estándar.  
FR Disque de coupe universelle construction, standard.  
EN Universal cutting disc for construction, standard.  
IT Disco da taglio universale, standard e per edilizia.  
PT Disco de corte universal construção, standard.

Ref	Ø	⊙	⊗	📦	📊	📄
1009 1115	115 mm	22,2 mm	10 mm	1	23,60	✓
1027 0230	230 mm	22,2 mm	12 mm	1	62,50	✓

DISCO DIAMANTE CANTERO ALTO RENDIMIENTO / DISQUE DE DIAMANT TAILLE PIERRES HAUT RENDEMENT  
DIAMOND DISC, STONE BREAKER, HIGH PERFORMANCE / DISCO MURATORE DIAMANTATO, AD ALTO RENDIMENTO  
DISCOS DE DIAMANTE QUEBRA-PEDRA ALTO DESEMPENHO

LÁSER ALTO RENDIMIENTO



ES Cantero construcción profesional de alto rendimiento. Excelente corte en seco o húmedo.  
FR Excellent usage general de travaux. Excellente coupe sec et eau.  
EN Excellent performance in construction materials. Excellent for wet or dry cut.  
IT Eccellenti prestazioni in materiali da costruzione. Eccellente taglio umido e secco.  
PT Excelente desempenho em materiais de construção. Excelente para corte úmido ou seco.

Ref	Ø	⊙	⊗	📦	📊	📄
1013 0230	230 mm	22,2 mm	10 mm	1	147,50	✓

DISCO DIAMANTE CANTERO SILENCIOSO / DISQUE DE DIAMANT TAILLE PIERRES SILENCIEUX  
DIAMOND DISC, STONE BREAKER, SILENT / DISCO MURATORE DIAMANTATO, SILENCIOSO / DISCOS DE DIAMANTE QUEBRA-PEDRA, SILENCIOSO

LÁSER SILENCIOSO



ES Granito profesional, materiales muy abrasivos, tejas, piedra arenisca y granito. Excelente corte en seco o húmedo. REDUCE EL NIVEL DE RUIDO HASTA EL 75%.  
FR Granit professionnel, pierre dure. Excellente coupe sec et eau. RÉDUCTION DU NIVEAU DE BRUIT JUSQU' À 75%.  
EN Professional granite. Very abrasive material, tiles, hard stones and granite. Excellent for wet or dry cut. REDUCE A NOISE LEVEL UP TO 75%.  
IT Materiale particolarmente abrasivo. Indicato per tegole, pietra, arenaria e granito. Eccellente taglio umido e secco. RIDUCE IL LIVELLO DI RUMORE FINO AL 75%.  
PT Granito profissional, materiais muito abrasivos, telhas, arenito e granito. Excelente corte a seco ou molhado. NIVEL DE RUIDO REDUZIDO ATÉ UM 75%.

Ref	Ø	⊙	⊗	📦	📊	📄
1012 1230	230 mm	22,2 mm	12 mm	1	205,80	✓
1012 1300	300 mm	25,4 mm	12 mm	1	325,40	✓

DISCOS DE DIAMANTE "MODELO CANTERO" PROFESIONAL / DISQUES DE DIAMANT "MODÈLE TAILLEUR DE PIERRES" PROFESSIONNEL  
DIAMOND DISCS "STONE BREAKER" PROFESSIONAL / DISCHI DIAMANTATI PROFESSIONALI "MODELLO MURATORE"  
DISCOS DE DIAMANTE "QUEBRA PEDRA" PROFISSIONAL

LÁSER PROFESIONAL



ES GRANITO PROFESIONAL. Materiales muy abrasivos, tejas, piedra arenisca y granito. Excelente corte en seco o húmedo.  
FR GRANIT PROFESSIONNEL. Matériaux très abrasifs, tuiles, pierre sablonneuse et granit. Excellente coupe sec et eau.  
EN PROFESSIONAL GRANITE. Very abrasive material, tiles, hard stones and granite. Excellent for wet or dry cut.  
IT GRANITO PROFESSIONALE. Materiale particolarmente abrasivo. Indicato per tegole, pietra arenaria e granito. Eccellente taglio umido e secco.  
PT GRANITO PROFISSIONAL. Materiais muito abrasivos, telha, arenito e granito. Excelente corte a seco ou molhado.

Ref	Ø	⊙	⊗	📦	📊	📄
1012 0230	230 mm	22,2 mm	12 mm	1	158,26	✓
1012 0300	300 mm	25,4 mm	12 mm	1	293,68	✓

DISCO DIAMANTE HORMIGÓN FRESCO / DISQUE DE DIAMANT BÉTON FRAIS / DIAMOND DISC, GREEN CONCRETE  
DISCO DIAMANTATO CALCESTRUZZO FRESCO / DISCO DE DIAMANTE BETÃO FRESCO

LÁSER



ES Hormigón fresco, alto rendimiento. Excelente corte en seco o húmedo. Uso para cortes de dilatación.  
FR Béton armé frais, longue vie. Excellente coupe sec et eau. Utilisation pour coupes de dilatation.  
EN Green concrete, longer life. Excellent for wet or dry cut. Use for cuts of dilation joints.  
IT Calcestruzzo fresco, lunga durata. Eccellente taglio umido e secco. Utilizzato per tagli di dilatazione.  
PT Betão fresco e de alta performance. Excelente corte seco ou molhado. Use para cortes de juntas de dilatação.

Ref	Ø	⊙	⊗	📦	📊	📄
1024 0300	300 mm	25,4 mm	10 mm	1	361,20	✓
1024 0350	350 mm	25,4 mm	10 mm	1	411,60	✓
1024 0400	400 mm	25,4 mm	10 mm	1	525,00	✓



DISCO DIAMANTE HORMIGÓN VIEJO Y ASFALTO / DISQUE DE DIAMANT BÉTON ANCIEN ET ASPHALTE / DIAMOND DISC, CONCRETE AND ASPHALT  
DISCO DIAMANTATO, CALCESTRUZZO VECCHIO ED ASFALTO / DISCO DE DIAMANTE BETÃO VELHO E ASFALTO

### LÁSER



ES Hormigón viejo y asfalto. Excelente corte en seco o húmedo.  
FR Béton vieille et asphalte. Excellente coupe sec et eau.  
EN Asphalt and concrete. Excellent for wet or dry cut.  
IT Calcestruzzo e asfalto. Eccellente taglio umido e secco.  
PT Betão antigo e asfalto. Excelente corte em seco ou molhado.

Ref	Ø	⊙	⊗	📦	📊	🚚
1023 0300	300 mm	25,4 mm	10 mm	1	239,40	✓
1023 0350	350 mm	25,4 mm	10 mm	1	294,20	✓
1023 0400	400 mm	25,4 mm	10 mm	1	344,50	✓

DISCO DIAMANTE ESPECÍFICO HORMIGÓN FRESCO SILENCIOSO / DISQUE DE DIAMANT SPÉCIFIQUE BÉTON FRAIS SILENCIEUX  
DIAMOND DISC, GREEN CONCRETE, SILENT / DISCO DIAMANTATO SPECIFICO PER CALCESTRUZZO FRESCO, DISCO SILENCIOSO  
DISCO DE DIAMANTE ,ESPECÍFICO PARA BETÃO FRESCO, SILENCIOSO

### LÁSER SILENCIOSO



ES Excelente corte en seco o húmedo. Uso específico para hormigón fresco, excelente corte también en asfalto y hormigón viejo. Uso para cortes de dilatación. REDUCE EL NIVEL DE RUIDO HASTA EL 75%.  
FR Excellente coupe sec et eau. Utilisation spécifique pour béton frais, coupe excellente également de l'asphalte et béton ancien. Utilisation pour coupes de dilatation. RÉDUCTION DU NIVEAU DE BRUIT JUSQU'À 75%.  
EN Excellent for wet or dry cut. Special use for green concrete as well as excellent use for asphalt and concrete. Excellent for wet or dry cut. REDUCE A NOISE LEVEL UP TO 75%.  
IT Eccellente taglio umido e secco. Uso specifico per calcestruzzo fresco e vecchio, eccellente anche per asfalto. Utilizzato per tagli di dilatazione. RIDUCE IL LIVELLO DI RUMORE FINO AL 75%.  
PT Excelente corte a seco ou molhado. Uso específico para o betão fresco, excelente corte também em asfalto e betão antigo. Uso para cortes de expansão. REDUZ O NIVEL DE RUIDO PARA 75%.

Ref	Ø	⊙	⊗	📦	📊	🚚
1025 0350	350 mm	25,4 mm	10 mm	1	471,90	✓

DISCO DE DIAMANTE "EXTRAFINO" ESPECIAL MATERIAL PORCELÁNICO  
DISQUES DE DIAMANT "EXTRA-FIN" SPÉCIAL MATÉRIEL EN PORCELÁINE GRÈS / PORCELLANIC SUPER THIN, SPECIAL FOR PORCELAIN  
DISCO DIAMANTATO "FINISSIMO", MATERIALE IN PORCELLANA / DISCOS DE DIAMANTE "EXTRAFINO" PARA MATERIAL ESPECIAL DE PORCELANA

### PORCELÁNICO



ES Disco diamante extrafino. Corte rápido y preciso en materiales cerámicos muy duros. Especial porcelanato. Excelente corte en seco o húmedo.  
FR Special porcelaine, tres mince. Coupe rapide et précise, extra fin. Excellente coupe sec et eau.  
EN Porcellanic super thin diamond discs. Fast and precise cut in hard ceramic materials. Specially in porcelain. Excellent for wet or dry cut.  
IT Disco diamantato finissimo. Veloce e preciso nel taglio, duraturo. Materiale ceramico. Eccellente taglio umido e secco.  
PT Disco de diamante extrafino. Corte rápido e preciso em materiais cerâmicos muito duros. Porcelana especial. Excelente corte a seco ou molhado.

Ref	Ø	⊙	MODEL	⊗	📦	📊	🚚
1015 0115	115 mm	22,2 mm	Extrafino / Super thin	7 mm	1	33,92	✓
1015 0125	125 mm	22,2 mm	Extrafino / Super thin	7 mm	1	56,99	✓
1015 0230	230 mm	22,2 mm	Extrafino / Super thin	7 mm	1	94,39	✓
1015 0300	300 mm	25,4 mm	Extrafino / Super thin	7 mm	1	213,20	✓

DISCO DIAMANTE PORCELÁNICO EXTRAFINO / DISQUES DE DIAMANT POUR CARRELAGE, EXTRA FIN / PORCELAIN DIAMOND DISC, EXTRA THIN  
DISCHI DI DIAMANTE PORCELLANATO, SUPERFINE / DISCOS DE DIAMANTE PORCELÁNICO, SUPER FINO

### PORCELÁNICO PROFESIONAL



ES Propiedades: gres porcelánico súper fino reforzado, alto rendimiento.  
FR Propriétés: Grès, carrelage super fin renforcé, haut rendement.  
EN Properties: ceramic tiles, super thin reinforced, long life.  
IT Proprietà: gres porcellanato superfine, rinforzato, ad alte prestazioni.  
PT Propriedades: grés porcelânico super fino reforçado e de alto desempenho.

Ref	Ø	⊙	MODEL	⊗	📦	📊	🚚
1028 0115	115 mm	22,2 mm	Extrafino / Super thin	10 mm	1	46,13	✓
1028 0125	125 mm	22,2 mm	Extrafino / Super thin	10 mm	1	64,94	✓
1028 0230	230 mm	22,2 mm	Extrafino / Super thin	10 mm	1	118,82	✓



DISCO PORCELÁNICO MÁQUINAS DE MESA / DISQUE CARRELAGE MACHINES DE TABLE / PORCELAIN DISC FOR WORK BENCHES  
DISCO IN PORCELLANA PER BANCHI DA LAVORO / DISCO PORCELÁNICO P/ CORTADORAS DE BANCADA

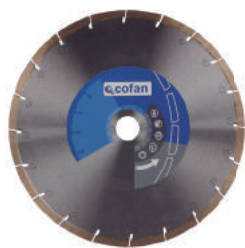

- Porcelánicos duros, Dekton® y piedras artificiales duras.
- Ideal para máquinas de mesa de pequeño tamaño.

Ref	Ø	⊙	⊗	📦	📊	📄
1029 0200	200 mm	25,4 mm	7 mm	1	221,75	✓
1029 0250	250 mm	25,4 mm	7 mm	1	235,10	✓
1029 0300	300 mm	25,4 mm	7 mm	1	259,30	✓

CORONA DOBLE PISTA MAMPOSTERÍA / COURONNE DOUBLE PISTE MAÇONNERIE / DOUBLE RING DISC FOR MASONRY  
FORETTI DOPPIA PISTA PER MATTONE / MÓ DIAMANTADA DUPLA PISTA



- Ideal para desbaste de paredes, muros, granitos, piedras y hormigones. Ideal para albañilería.
- Corona doble pista para ladrillos, cemento y mampostería en general.

Ref	Ø	⊙	📦	📊	📄
0929 2601	100 mm	22,2 mm	1	51,45	✓
0929 2602	125 mm	22,2 mm	1	57,81	✓
0929 2603	180 mm	22,2 mm	1	88,10	✓

DISCOS DE DIAMANTE "ESPECIAL MÁRMOL" / DISQUES DE DIAMANT "SPÉCIAL MARBRE" / DIAMOND DISCS "SPECIAL MARBLE"  
DISCO DIAMANTATO "MARMO SPECIALE" / DISCOS DE DIAMANTE "ESPECIAL MÁRMORE"

### ELECTRODEPOSITADO



- ES Electrodepositado reforzado en talla reducida. Corte en seco. Reforzado con brida.
- FR Electrodisque avec renfort. Coupe à sec. Renforcé avec bride.
- EN Electroplated blade with enforcement pad. Dry cut.
- IT Dischi rinforzati mediante processo di elettrodeposizione. Taglio a secco. Rinforzato con brida.
- PT Galvanizado reforçado entalhe reduzido. Corte em seco.

Ref	Ø	⊙	MODEL	📦	📊	📄
1018 0115	115 mm	22,2 mm	mármol / marble	1	65,10	✓
1018 0125	125 mm	22,2 mm	mármol / marble	1	75,60	✓
1018 0180	180 mm	22,2 mm	mármol / marble	1	106,70	✓
1018 0230	230 mm	22,2 mm	mármol / marble	1	152,40	✓

DISCO ESPECIAL CARBURO MATERIALES BLANDOS / DISQUE SPÉCIAL « CARBURE » POUR MATÉRIEAUX SOUPLES  
SPECIAL "CARBURE" CUTTING DISC FOR SOFT MATERIALS / DISCO SPECIALE "CARBURE" PER MATERIALI MORBIDI  
DISCO ESPECIAL DE CARBONETO MATERIAIS MOLES



### EN 13236

Use as directed in:

EU: FEPA Safety Code

- ES El disco CARBURO permite cortar de manera fácil y segura materiales blandos. ALTA VELOCIDAD DE CORTE gracias al fino espesor 1 mm con grano de carburo fundido por láser. Para corte de madera, madera con clavos, plástico, cartón-yeso y tubos de cobre.
- FR SÉCURITÉ : Le disque CARBURE permet de couper facilement et en toute sécurité des matériaux souples. GRANDE VITESSE DE COUPE grâce à l'épaisseur fine de 1 mm avec grain de carbure fondu au laser. Pour couper du bois, du bois avec des clous, du plastique, des plaques de plâtre et des tuyaux en cuivre.
- EN SECURITY: The cutting disc CARBURE is designed for cutting soft materials easily and securely. HIGH CUTTING SPEED due to its thickness edges of 1 mm in which features a carbide grit by laser melting technology. It is suitable for cutting wood (also with nails), plastics, plasterboard and copper tubes.
- IT SICUREZZA: Questo disco in carburo permette di tagliare materiali morbidi in modo semplice e sicuro. ALTA VELOCITÀ DI TAGLIO fornita grazie al suo sottile spessore di 1 mm con un grano di carburo stampato da laser. È idoneo per tagliare legno (anche con chiodi), plastiche, cartongesso e tubi in rame.
- PT O disco de carboneto permite cortar de maneira fácil e segura materiais moles. ALTA VELOCIDADE DE CORTE devido à espessura fina de 1mm com grão de carboneto fundido a laser. Para corte de madeira, madeira com pregos, plástico, gesso-cartonado e tubos de cobre.



Madera / Wood / Madeira



Tubo de plástico / Plastic tube  
Tubo de plástico



Cartón yeso / Dry wall  
Gesso cartonado

Ref	Ø	⊙	📦	📊	📄
0929 2610	115 x 1 mm	22,23 mm	1	12,10	✓
0929 2611	125 x 1 mm	22,23 mm	1	14,23	✓



			1011 0115	1012 0230		1028 0200							
			1011 0125	1012 0300	1014 0115	1028 0250	1017 0115	1018 0115	1024 0300			1028 0115	
1009 0115	1010 0115	1009 0125	1010 0125	1011 0230	1013 0230	1015 0115	1017 0125	1018 0125	1024 0350	1023 0300	1009 1115	1028 0125	
1009 0230	1010 0230			1016 0300	1012 1230	1014 0230	1015 0125	1017 0230	1018 0180	1024 0400	1027 0230	1028 0230	
				1016 0350	1012 1300		1015 0230	1017 0300	1018 0230	1025 0350			
							1015 0300						

CERÁMICA / CÉRAMIQUE / CERAMIC CERAMICA / CERÂMICA	●	●	●	●	●	***	●	●	●	●	●	***	
AZULEJOS / CARREAUX / TILES PIASTRELLA / AZULEJOS	●	●	●	●	●	***	●	●	●	●	●	***	
GRES / GRÉS / GRES / GRES / GRES	●	●	●	●	●	***	●	●	●	●	●	***	
PORCELANA / PORCELAINE GRÉS PORCELAIN / PORCELLANA GRES PORCELANA	●	●	●	●	●	***	●	●	●	●	●	***	
FERROGRÉS / FERROGRES FERROGRES FERROGRÉS / FERROGRES (PORCELLANA RESISTENTE)	●	●	●	*	●	**	●	●	●	●	*	***	
UNIVERSAL / UNIVERSEL / UNIVERSAL UNIVERSALE / UNIVERSAL	**	**	***	***	***	●	***	●	●	●	***	**	
GRANITO PIEDRA DURA GRANIT PIERRE DURE GRANITE HARD STONE / GRANITO PIETRA DURA GRANITO PEDRA DURA	●	●	*	***	●	●	*	●	●	●	**	●	
GRANITO PIEDRA BLANDA GRANIT ABRASIF / GRANITE SOFT STONE GRANITO PIETRA MORBIDA GRANITO PEDRA SUAVE	●	●	*	**	*	●	*	*	●	●	**	●	
CEMENTO / BÉTON CONCRETE / CEMENTO / BETÃO	●	●	**	**	*	●	**	●	●	●	**	●	
TEJA TERRAZO PIZARRA TUILE / ROOF TILES PIASTRELLA TERRAZZO TEGOLA / TELHAS	●	**	**	**	**	●	**	●	●	●	**	●	
LADRILLO CARAVISTA / BRIQUE ABRASIVE BRICKS / MATTONE TIJOLOS ABRASIVOS	●	*	*	**	*	●	*	●	●	●	**	●	
ARENISCA / PIERRE RECONSTITUÉE SANDSTONE / PIETRA ARENARIA / ARENITO	●	*	*	**	*	●	*	●	●	●	*	●	
MÁRMOL / MARBRE / MARBLE MARMO / MÁRMORE	●	●	●	●	●	●	●	***	●	●	●	●	
HORMIGÓN FRESCO / BÉTON ARMÉ FRAIS GREEN CONCRETE CALCESTRUZZO FRESCO BETÃO FRESCO	●	*	*	**	*	●	*	●	***	●	*	●	
HORMIGÓN VIEJO Y ASFALTO BÉTON VIEILLE ET ASPHALTE ASPHALT AND CONCRETE CALCESTRUZZO E ASFALTO BETÃO ANTIGO E ASFALTO	●	*	**	**	**	●	**	●	***	***	**	●	

\*\*\*

\*\*

\*

●

ES	MUY RECOMENDADO	RECOMENDADO	POCO RECOMENDADO	NO RECOMENDADO
FR	TRÉS RECOMMANDÉ	RECOMMANDÉ	PEU RECOMMANDÉ	NON RECOMMANDÉ
EN	HIGHLY RECOMMENDED	RECOMMENDED	LESS RECOMMENDED	NOT RECOMMENDED
IT	MOLTO RACCOMANDATO	RACCOMANDATO	POCO RACCOMANDATO	NON RACCOMANDATO
PT	ALTAMENTE RECOMENDADO	RECOMENDADO	MENOS RECOMENDADO	NÃO RECOMENDADO





PLIEGO LIJA AL AGUA / PAPIER ABRASIF UTILISABLE POUR L'EAU / WATER ABRASIVE PAPER  
 PLICO CARTA ABRASIVA ALL'ACQUA / FOLHA LIXA DE ÁGUAW

**Al agua**  
**Water**



Ref					unid
0972 1100	100	230 x 280 mm	100 pliegos	1000	<b>0,46</b>
0972 1180	180	230 x 280 mm	100 pliegos	1000	<b>0,46</b>
0972 1240	240	230 x 280 mm	100 pliegos	1000	<b>0,46</b>
0972 1280	280	230 x 280 mm	100 pliegos	1000	<b>0,46</b>
0972 1320	320	230 x 280 mm	100 pliegos	1000	<b>0,46</b>
0972 1400	400	230 x 280 mm	100 pliegos	1000	<b>0,46</b>
0972 1600	600	230 x 280 mm	100 pliegos	1000	<b>0,46</b>
0972 1800	800	230 x 280 mm	100 pliegos	1000	<b>0,46</b>
0972 11000	1.000	230 x 280 mm	100 pliegos	1000	<b>0,46</b>
0972 11500	1.500	230 x 280 mm	100 pliegos	1000	<b>0,46</b>
0972 1997	2.000	230 x 280 mm	100 pliegos	1000	<b>0,46</b>
0972 1998	2.500	230 x 280 mm	100 pliegos	1000	<b>0,46</b>
0972 1999	3.000	230 x 280 mm	100 pliegos	1000	<b>0,46</b>

PLIEGO TELA ESMERIL METAL / PAPIER ABRASIF TOILE ÉMERIS / ABRASIVE EMERY CLOTH  
 PLICO CARTA ABRASIVA METALLO / FOLHA LIXA DE ESMERIL METAL

**Metal**



Ref					unid
0972 2040	40	230 x 280 mm	50 pliegos		<b>0,62</b>
0972 2050	50	230 x 280 mm	50 pliegos		<b>0,62</b>
0972 2060	60	230 x 280 mm	50 pliegos		<b>0,62</b>
0972 2080	80	230 x 280 mm	50 pliegos		<b>0,62</b>
0972 2100	100	230 x 280 mm	50 pliegos		<b>0,62</b>
0972 2120	120	230 x 280 mm	50 pliegos		<b>0,62</b>
0972 2150	150	230 x 280 mm	50 pliegos		<b>0,62</b>
0972 2180	180	230 x 280 mm	50 pliegos		<b>0,62</b>

PLIEGO LIJA MADERA/PARED / PAPIER ABRASIF POUR LE BOIS / ABRASIVE PAPER FOR WOOD-WALL  
 PLICO CARTA ABRASIVA LEGNO / FOLHA LIXA MADERA/PARED

**Madera**  
**Wood**



Ref					unid
0972 3040	40	230 x 280 mm	50 pliegos		<b>0,26</b>
0972 3050	50	230 x 280 mm	50 pliegos		<b>0,26</b>
0972 3060	60	230 x 280 mm	50 pliegos		<b>0,26</b>
0972 3080	80	230 x 280 mm	50 pliegos		<b>0,26</b>
0972 3100	100	230 x 280 mm	50 pliegos		<b>0,26</b>
0972 3120	120	230 x 280 mm	50 pliegos		<b>0,26</b>
0972 3150	150	230 x 280 mm	50 pliegos		<b>0,26</b>
0972 3180	180	230 x 280 mm	50 pliegos		<b>0,26</b>





ROLLO LIJA DE PAPEL / ROULEAU PAPIER ABRASIF / ABRASIVE PAPER IN ROLL / ROTOLO CARTA VETRATA / ROLO LIXA DE PAPEL



Ref				unid
0972 4060	60	100 mm x 25 m	1	16,04
0972 4080	80	100 mm x 25 m	1	16,04
0972 4100	100	100 mm x 25 m	1	13,00
0972 4120	120	100 mm x 25 m	1	13,00
0972 4180	180	100 mm x 25 m	1	13,00

ROLLO LIJA TELA UNIVERSAL / ROULEAU PAPIER ABRASIF TISSUS UNIVERSEL / ABRASIVE CLOTH IN ROLL  
CARTA ABRASIVA UNIVERSALE / ROLO LIXA UNIVERSAL

Ref				unid
0972 5060	60	100 mm x 25 m	1	49,50
0972 5080	80	100 mm x 25 m	1	46,50
0972 5120	120	100 mm x 25 m	1	45,00
0972 5180	180	100 mm x 25 m	1	45,00

ESPONJA TACO DE LIJA GRANO GRUESO / ÉPONGE PAPIER A PONÇER GRAIN EPAIS / COARSE GRAIN SANDING SPONGE  
SPUGNA ABRASIVA CON GRANA GROSSA / ESPONJA DE LIXAR GRÃO GROSSO

PACK 2 PCS



Ref		PACK		x pack
0972 0850	125 x 2 PCS	2 uds	125 packs	2,24

ESPONJA TACO DE LIJA GRANO MEDIO / ÉPONGE PAPIER A PONÇER GRAIN MOYEN / MEDIUM GRAIN SANDING SPONGE  
SPUGNA ABRASIVA CON GRANA MEDIA / ESPONJA DE LIXAR GRÃO MÉDIO

PACK 2 PCS



Ref		PACK		x pack
0972 0851	125 x 2 PCS	2 uds	125 packs	2,24

ESPONJA TACO DE LIJA GRANO FINO / ÉPONGE PAPIER A PONÇER GRAIN FIN / FINE GRAIN SANDING SPONGE  
SPUGNA ABRASIVA CON GRANA FINE / ESPONJA DE LIXAR GRÃO FINO

PACK 2 PCS



Ref		PACK		x pack
0972 0852	125 x 2 PCS	2 uds	125 packs	2,24



ESTUCHE BROCAS / TROUSSE FORETS / CASE WITH DRILLS / SET DI PUNTE METALLO / ESTOJO BROCAS

6 pcs



METAL HSS DIN 338N

Ref	Ø	
0973 8126	2 - 3 - 4 - 5 - 6 - 8 mm	12,29

10 pcs



METAL HSS DIN 338N

Ref	Ø	
0973 8124	1 - 2 - 3 - 4 - 5 - 6 - 7 - 8 - 9 - 10 mm	25,06

13 pcs



METAL HSS DIN 338N

Ref	Ø	
0973 8125	2 - 2,5 - 3 - 3,5 - 4 - 4,5 - 5 - 5,5 - 6 - 6,5 - 7 - 7,5 - 8 mm	24,25



**BROCAS HSS-DIN 338 N / FORETS HSS-DIN 338 N / HSS DRILL DIN 338 N / PUNTE HSS-DIN 338 N / BROCAS HSS-DIN 338 N**

**HSS**

ES Broca en acero rápido rectificada y punta de 118° afiladas.

FR Foret en acier rapide rectifié et embout de 118° effilé.

EN High speed steel drill, 118° sharp point.

IT Punta in acciaio rapido rettificato. Punta da 118°.

PT Broca em aço rápida retificada e ponta de 118°, aguçada.



Ref	Ø			Ref	Ø			Ref	Ø		
0973 0070	0,7 mm	10	1,66	0973 0550	5,5 mm	10	1,42	0973 1150	11,5 mm	5	6,17
0973 0080	0,8 mm	10	1,55	0973 0575	5,75 mm	10	1,93	0973 1200	12,0 mm	5	6,56
0973 0090	0,9 mm	10	1,55	0973 0600	6,0 mm	10	1,50	0973 1250	12,5 mm	5	7,37
0973 0100	1,0 mm	10	0,95	0973 0625	6,25 mm	10	2,28	0973 1300	13,0 mm	5	8,06
0973 0150	1,5 mm	10	0,82	0973 0650	6,5 mm	10	1,93	0973 1350	13,5 mm	4	10,24
0973 0200	2,0 mm	10	0,78	0973 0700	7,0 mm	10	2,54	0973 1400	14,0 mm	4	11,10
0973 0225	2,25 mm	10	0,86	0973 0750	7,5 mm	10	2,49	0973 1450	14,5 mm	4	12,64
0973 0250	2,5 mm	10	0,78	0973 0775	7,75 mm	10	3,28	0973 1500	15,0 mm	4	14,44
0973 0275	2,75 mm	10	0,86	0973 0800	8,0 mm	10	2,62	0973 1550	15,5 mm	1	17,62
0973 0300	3,0 mm	10	0,69	0973 0825	8,25 mm	10	3,56	0973 1600	16,0 mm	1	17,62
0973 0325	3,25 mm	10	0,86	0973 0850	8,5 mm	10	3,26	0973 1650	16,5 mm	1	22,49
0973 0350	3,5 mm	10	0,86	0973 0875	8,75 mm	10	3,91	0973 1700	17,0 mm	1	22,49
0973 0375	3,75 mm	10	1,14	0973 0900	9,0 mm	10	3,56	0973 1725	17,25 mm	1	30,22
0973 0400	4,0 mm	10	0,86	0973 0950	9,5 mm	10	3,99	0973 1750	17,5 mm	1	25,07
0973 0425	4,25 mm	10	1,12	0973 1000	10,0 mm	5	4,07	0973 1800	18,0 mm	1	25,07
0973 0450	4,5 mm	10	1,12	0973 1025	10,25 mm	5	5,53	0973 1850	18,5 mm	1	26,78
0973 0475	4,75 mm	10	1,54	0973 1050	10,5 mm	5	5,02	0973 1900	19,0 mm	1	27,98
0973 0500	5,0 mm	10	1,07	0973 1075	10,75 mm	5	6,17	0973 1950	19,5 mm	1	30,84
0973 0525	5,25 mm	10	1,42	0973 1100	11,0 mm	5	5,57	0973 2000	20,0 mm	1	33,54

**HSS**



Precio por blíster / Price for blister

Ref	Ø				Ref	Ø			
0973 0100BL	1 mm	1 blister x 3 uds	4,26	✓	0973 0550BL	5,5 mm	1 blister x 1 ud	2,53	✓
0973 0150BL	1,5 mm	1 blister x 3 uds	3,75	✓	0973 0600BL	6 mm	1 blister x 1 ud	2,61	✓
0973 0200BL	2 mm	1 blister x 3 uds	3,64	✓	0973 0650BL	6,5 mm	1 blister x 1 ud	3,14	✓
0973 0250BL	2,5 mm	1 blister x 3 uds	2,46	✓	0973 0700BL	7 mm	1 blister x 1 ud	3,51	✓
0973 0300BL	3 mm	1 blister x 2 uds	2,86	✓	0973 0750BL	7,5 mm	1 blister x 1 ud	3,88	✓
0973 0325BL	3,25 mm	1 blister x 2 uds	2,86	✓	0973 0800BL	8 mm	1 blister x 1 ud	4,02	✓
0973 0350BL	3,5 mm	1 blister x 2 uds	1,81	✓	0973 0850BL	8,5 mm	1 blister x 1 ud	4,86	✓
0973 0400BL	4 mm	1 blister x 1 ud	2,14	✓	0973 0900BL	9 mm	1 blister x 1 ud	5,21	✓
0973 0425BL	4,25 mm	1 blister x 1 ud	2,14	✓	0973 1000BL	10 mm	1 blister x 1 ud	5,89	✓
0973 0450BL	4,5 mm	1 blister x 1 ud	2,14	✓	0973 1100BL	11 mm	1 blister x 1 ud	7,80	✓
0973 0500BL	5 mm	1 blister x 1 ud	2,12	✓	0973 1200BL	12 mm	1 blister x 1 ud	9,03	✓
0973 0525BL	5,25 mm	1 blister x 1 ud	2,24	✓	0973 1300BL	13 mm	1 blister x 1 ud	10,96	✓

**HSS**



**cofan Bricofan**

Precio por blíster / Price for blister

Ref	Ø				Ref	Ø			
6200 0150	1,5 mm	1 blister x 3 uds	3,94	✓	6200 0650	6,5 mm	1 blister x 1 ud	3,31	✓
6200 0200	2 mm	1 blister x 3 uds	3,81	✓	6200 0700	7 mm	1 blister x 1 ud	3,69	✓
6200 0250	2,5 mm	1 blister x 3 uds	3,81	✓	6200 0750	7,5 mm	1 blister x 1 ud	4,07	✓
6200 0300	3 mm	1 blister x 2 uds	2,57	✓	6200 0800	8 mm	1 blister x 1 ud	4,20	✓
6200 0350	3,5 mm	1 blister x 2 uds	3,01	✓	6200 0850	8,5 mm	1 blister x 1 ud	5,10	✓
6200 0400	4 mm	1 blister x 1 ud	1,94	✓	6200 0900	9 mm	1 blister x 1 ud	5,49	✓
6200 0450	4,5 mm	1 blister x 1 ud	2,30	✓	6200 1000	10 mm	1 blister x 1 ud	6,22	✓
6200 0500	5 mm	1 blister x 1 ud	2,23	✓	6200 1100	11 mm	1 blister x 1 ud	8,21	✓
6200 0550	5,5 mm	1 blister x 1 ud	2,65	✓	6200 1200	12 mm	1 blister x 1 ud	9,54	✓
6200 0600	6 mm	1 blister x 1 ud	2,73	✓	6200 1300	13 mm	1 blister x 1 ud	11,50	✓



BROCAS HSS SERIE LARGA HSS-DIN 340 N / FORÊT HSS-DIN 340 N TYPE LONG / HSS TWIST DRILLS LONG SERIES-DIN 340 N  
PUNTA HSS-DIN 340 N SERIE LUNGA / BROCAS HSS SÉRIE LONGA HSS-DIN 340 N

HSS



Serie larga  
long serie

Ref	∅	↔	📦	📊	Ref	∅	↔	📦	📊
0986 0100	1 mm	56 mm	10	2,97	0986 0900	9 mm	175 mm	10	8,74
0986 0150	1,50 mm	70 mm	10	2,97	0986 0950	9,50 mm	175 mm	10	10,21
0986 0200	2 mm	85 mm	10	2,54	0986 1000	10 mm	184 mm	5	10,21
0986 0225	2,25 mm	90 mm	10	2,78	0986 1050	10,50 mm	184 mm	5	13,93
0986 0250	2,50 mm	95 mm	10	2,53	0986 1100	11 mm	195 mm	5	13,93
0986 0300	3 mm	100 mm	10	2,53	0986 1150	11,50 mm	195 mm	5	16,64
0986 0325	3,25 mm	106 mm	10	3,29	0986 1200	12 mm	205 mm	5	16,64
0986 0350	3,50 mm	112 mm	10	3,00	0986 1250	12,50 mm	205 mm	5	19,86
0986 0400	4 mm	119 mm	10	3,00	0986 1300	13 mm	205 mm	5	19,86
0986 0425	4,25 mm	119 mm	10	4,22	0986 1350	13,50 mm	214 mm	1	25,01
0986 0450	4,50 mm	126 mm	10	3,93	0986 1400	14 mm	214 mm	1	25,01
0986 0500	5 mm	132 mm	10	3,83	0986 1450	14,50 mm	220 mm	1	27,88
0986 0525	5,25 mm	132 mm	10	5,03	0986 1500	15 mm	220 mm	1	27,88
0986 0550	5,50 mm	139 mm	10	4,55	0986 1550	15,50 mm	227 mm	1	30,45
0986 0575	5,75 mm	139 mm	10	5,14	0986 1600	16 mm	227 mm	1	30,20
0986 0600	6 mm	139 mm	10	4,55	0986 1650	16,50 mm	235 mm	1	41,79
0986 0625	6,25 mm	148 mm	10	6,39	0986 1700	17 mm	235 mm	1	41,79
0986 0650	6,50 mm	148 mm	10	5,81	0986 1750	17,50 mm	241 mm	1	46,11
0986 0700	7 mm	156 mm	10	5,81	0986 1800	18 mm	241 mm	1	46,11
0986 0725	7,25 mm	156 mm	10	7,81	0986 1850	18,50 mm	247 mm	1	52,53
0986 0750	7,50 mm	156 mm	10	7,10	0986 1900	19 mm	247 mm	1	52,53
0986 0800	8 mm	165 mm	10	7,10	0986 1950	19,50 mm	254 mm	1	56,75
0986 0850	8,50 mm	165 mm	10	8,74	0986 2000	20 mm	254 mm	1	56,75

BROCAS HSS SERIE EXTRA LARGA HSS-DIN 1869 N / FORET HSS-DIN 1869 N TYPE TRÈS LONG / HSS TWIST DRILLS EXTRA LONG SERIES -DIN 1869 N  
PUNTA HSS-DIN 1869 N SERIE EXTRALUNGA / BROCAS HSS SÉRIE EXTRA LONGA HSS-DIN 1869 N

HSS



Serie Extra larga  
Extra long series

Ref	∅	↔	📦	📊
0987 40175	4 mm	175 mm	1	13,20
0987 45185	4,5 mm	185 mm	1	16,18
0987 50195	5 mm	195 mm	1	15,47
0987 55205	5,5 mm	205 mm	1	22,50
0987 60205	6 mm	205 mm	1	19,43
0987 65215	6,5 mm	215 mm	1	24,04
0987 80240	8 mm	240 mm	1	30,34
0987 85240	8,5 mm	240 mm	1	46,41
0987 90250	9 mm	250 mm	1	39,74
0987 95250	9,5 mm	250 mm	1	53,65
0987 10265	10 mm	265 mm	1	43,35
0987 12300	12 mm	300 mm	1	79,90



**BROCAS HSS-DIN 338 N MANGO REDUCIDO / FORETS EMBOUT REDUIT HSS-DIN 338 N / HSS REDUCED SHANK DRILL DIN-338 N**  
**PUNTA HSS DIN 338 N GAMBO RIDOTTO / BROCAS HSS-DIN 338 N HASTE REDUZIDA**

**HSS**



ES Broca en acero rápido rectificada y punta de 118° afiladas. Mango reducido.  
 FR Foret en acier rapide rectifié et embout de 118° effilage normal. Embout réduit.  
 EN Ground twist drills, made from fast steel, 118° sharp point. Reduced shank.  
 IT Punta in acciaio rapido, rettificato. Punta da 118°, affilata. Gambo ridotto.  
 PT Broca em aço rápida retificada e ponta de 118°, aguçadas. Haste reduzida.

Ref	Ø				Ref	Ø			
0973 1000R	10,0 mm	8 mm	1	6,48	0973 1800R	18,0 mm	12 mm	1	26,48
0973 1050R	10,5 mm	8 mm	1	7,41	0973 1850R	18,5 mm	12 mm	1	29,73
0973 1100R	11,0 mm	8 mm	1	7,41	0973 1900R	19,0 mm	12 mm	1	29,73
0973 1150R	11,5 mm	8 mm	1	8,27	0973 1950R	19,5 mm	12 mm	1	35,05
0973 1200R	12,0 mm	8 mm	1	8,57	0973 2000R	20,0 mm	13 mm	1	35,05
0973 1250R	12,5 mm	8 mm	1	9,13	0973 2050R	20,5 mm	13 mm	1	40,83
0973 1300R	13,0 mm	10 mm	1	10,07	0973 2100R	21,0 mm	13 mm	1	40,83
0973 1350R	13,5 mm	10 mm	1	12,85	0973 2150R	21,5 mm	13 mm	1	44,46
0973 1400R	14,0 mm	10 mm	1	12,85	0973 2200R	22,0 mm	13 mm	1	44,47
0973 1450R	14,5 mm	10 mm	1	16,12	0973 2250R	22,5 mm	13 mm	1	47,00
0973 1500R	15,0 mm	10 mm	1	16,12	0973 2300R	23,0 mm	13 mm	1	47,00
0973 1550R	15,5 mm	10 mm	1	19,11	0973 2350R	23,5 mm	13 mm	1	52,34
0973 1600R	16,0 mm	12 mm	1	19,11	0973 2400R	24,0 mm	13 mm	1	52,34
0973 1650R	16,5 mm	12 mm	1	23,95	0973 2450R	24,5 mm	13 mm	1	53,08
0973 1700R	17,0 mm	12 mm	1	23,95	0973 2500R	25,0 mm	13 mm	1	53,08
0973 1750R	17,5 mm	12 mm	1	26,48					

**BROCA RECTIFICADA HSS MANGO HEX. 1/4" / FORET HSS MANCHE HEX. 1/4" / RECTIFIED HSS DRILL BIT WITH 1/4" HEXAGONAL HANDLE**  
**PUNTA RETTIFICATA HSS, MANICO ESAGONALE 1/4" / BROCA RETIFICADA HSS HASTE HEX. 1/4"**

**HSS**



ES Broca en HSS con mango hexagonal de 1/4". Afilado en cruz y ángulo de punta a 118°. Permite el cambio rápido de la broca. Aplicaciones: Aceros y fundición.  
 FR Forêt en HSS avec manche hexagonal de 1/4". Aiguisé en croix et angle de pointe à 118°. Permet un changement rapide du forêt. Applications: Aciers et fonderie.  
 EN HSS drill bit with a 1/4" hexagonal handle and with a cross shaped point of 118°. Quick change system of drill bit. Application: Steel and cast iron.  
 IT Punta HSS con manico esagonale da 1/4". Angolo punta 118°. Permette il cambio rapido di trapano. Applicazioni: Acciaio e ghisa.  
 PT Broca em HSS com haste hexagonal de 1/4". Aguçada em cruz e ângulo de ponta a 118°. Troca rápida da broca. Aplicação: Aço e ferro fundido.

Ref	Ø			
0973 5003	3 mm	1	7,30	✓
0973 5004	4 mm	1	8,06	✓
0973 5005	5 mm	1	8,37	✓
0973 5006	6 mm	1	9,03	✓
0973 5007	7 mm	1	9,29	✓
0973 5008	8 mm	1	9,64	✓
0973 5009	9 mm	1	9,96	✓
0973 5110	10 mm	1	12,55	✓





BROCAS COBALTO HSS-CO DIN-338 N / FORETS COBALT HSS-CO DIN-338 N / HSS-CO DIN-338 N TWIST DRILLS  
PUNTE COBALTO HSS-CO DIN 338N / BROCAS COBALTO HSS-CO DIN-338 N

HSS-CO



ES Brocas de alto rendimiento, rectificadas, con contenido de cobalto, afilado en cruz y refuerzo total del alma.  
FR Foret pour fort rendement, rectifié avec de cobalt, aiguisé en croix et renforcement total.  
EN High-performance, contains cobalt, cross sharp point and totally reinforced body.  
IT Punta ad alto rendimento, rettificata, al cobalto, affilato a croce, con rinforzo totale dell'anima.  
PT Brocas de alto desempenho, retificadas, contendo cobalto, aguçadas em cruz e reforço total do interior.

Ref	Ø	📦	📊	Ref	Ø	📦	📊	Ref	Ø	📦	📊
0974 0100	1,0 mm	10	1,58	0974 0550	5,5 mm	10	3,17	0974 1200	12,0 mm	5	14,97
0974 0125	1,25 mm	10	1,84	0974 0575	5,75 mm	10	3,42	0974 1250	12,5 mm	5	19,49
0974 0150	1,5 mm	10	1,46	0974 0600	6,0 mm	10	3,21	0974 1300	13,0 mm	5	19,80
0974 0200	2,0 mm	10	1,53	0974 0625	6,25 mm	10	4,18	0974 1350	13,5 mm	4	26,63
0974 0225	2,25 mm	10	2,39	0974 0650	6,5 mm	10	3,52	0974 1400	14,0 mm	4	26,32
0974 0250	2,5 mm	10	1,59	0974 0675	6,75 mm	10	4,82	0974 1450	14,5 mm	4	37,29
0974 0275	2,75 mm	10	1,89	0974 0700	7,0 mm	10	3,69	0974 1500	15,0 mm	4	37,91
0974 0300	3,0 mm	10	1,43	0974 0725	7,25 mm	10	5,02	0974 1550	15,5 mm	1	42,64
0974 0325	3,25 mm	10	1,93	0974 0750	7,5 mm	10	3,95	0974 1600	16,0 mm	1	45,45
0974 0350	3,5 mm	10	1,76	0974 0800	8,0 mm	10	4,92	0974 1650	16,5 mm	1	50,49
0974 0375	3,75 mm	10	2,17	0974 0850	8,5 mm	10	5,60	0974 1700	17,0 mm	1	51,98
0974 0400	4,0 mm	10	1,75	0974 0900	9,0 mm	10	6,23	0974 1750	17,5 mm	1	50,74
0974 0425	4,25 mm	10	2,02	0974 0950	9,5 mm	10	7,71	0974 1800	18,0 mm	1	62,72
0974 0450	4,5 mm	10	2,10	0974 1000	10,0 mm	5	7,71	0974 1850	18,5 mm	1	69,23
0974 0475	4,75 mm	10	2,54	0974 1050	10,5 mm	5	10,29	0974 1900	19,0 mm	1	69,23
0974 0500	5,0 mm	10	2,13	0974 1100	11,0 mm	5	11,31	0974 1950	19,5 mm	1	74,61
0974 0525	5,25 mm	10	2,53	0974 1150	11,5 mm	5	14,52	0974 2000	20,0 mm	1	88,75

HSS-CO



Precio por blíster / Price for blister

Ref	Ø	📦	📊	📦	Ref	Ø	📦	📊	📦
0974 0100BL	1 mm	1 blister x 3 uds	6,12	✓	0974 0550BL	5,5 mm	1 blister x 1 ud	4,54	✓
0974 0150BL	1,5 mm	1 blister x 3 uds	5,92	✓	0974 0600BL	6 mm	1 blister x 1 ud	3,97	✓
0974 0200BL	2 mm	1 blister x 3 uds	6,08	✓	0974 0650BL	6,5 mm	1 blister x 1 ud	4,93	✓
0974 0250BL	2,5 mm	1 blister x 3 uds	6,42	✓	0974 0700BL	7 mm	1 blister x 1 ud	5,16	✓
0974 0300BL	3 mm	1 blister x 2 uds	3,83	✓	0974 0750BL	7,5 mm	1 blister x 1 ud	5,47	✓
0974 0325BL	3,25 mm	1 blister x 2 uds	4,96	✓	0974 0800BL	8 mm	1 blister x 1 ud	6,63	✓
0974 0350BL	3,5 mm	1 blister x 2 uds	4,89	✓	0974 0850BL	8,5 mm	1 blister x 1 ud	6,59	✓
0974 0400BL	4 mm	1 blister x 1 ud	2,76	✓	0974 0900BL	9 mm	1 blister x 1 ud	8,15	✓
0974 0425BL	4,25 mm	1 blister x 1 ud	3,12	✓	0974 1000BL	10 mm	1 blister x 1 ud	10,06	✓
0974 0450BL	4,5 mm	1 blister x 1 ud	3,22	✓	0974 1100BL	11 mm	1 blister x 1 ud	11,50	✓
0974 0500BL	5 mm	1 blister x 1 ud	3,12	✓	0974 1200BL	12 mm	1 blister x 1 ud	18,05	✓
0974 0525BL	5,25 mm	1 blister x 1 ud	3,37	✓	0974 1300BL	13 mm	1 blister x 1 ud	24,83	✓

HSS-CO



Precio por blíster / Price for blister

Ref	Ø	📦	📊	📦	Ref	Ø	📦	📊	📦
6210 0150	1,5 mm	1 blister x 3 uds	6,21	✓	6210 0650	6,5 mm	1 blister x 1 ud	5,18	✓
6210 0200	2 mm	1 blister x 3 uds	6,38	✓	6210 0700	7 mm	1 blister x 1 ud	5,46	✓
6210 0250	2,5 mm	1 blister x 3 uds	6,74	✓	6210 0750	7,5 mm	1 blister x 1 ud	5,74	✓
6210 0300	3 mm	1 blister x 2 uds	4,02	✓	6210 0800	8 mm	1 blister x 1 ud	6,96	✓
6210 0350	3,5 mm	1 blister x 2 uds	5,15	✓	6210 0850	8,5 mm	1 blister x 1 ud	6,90	✓
6210 0400	4 mm	1 blister x 1 ud	2,89	✓	6210 0900	9 mm	1 blister x 1 ud	8,54	✓
6210 0450	4,5 mm	1 blister x 1 ud	3,39	✓	6210 1000	10 mm	1 blister x 1 ud	10,56	✓
6210 0500	5 mm	1 blister x 1 ud	3,26	✓	6210 1100	11 mm	1 blister x 1 ud	15,25	✓
6210 0550	5,5 mm	1 blister x 1 ud	4,78	✓	6210 1200	12 mm	1 blister x 1 ud	18,92	✓
6210 0600	6 mm	1 blister x 1 ud	4,18	✓	6210 1300	13 mm	1 blister x 1 ud	26,05	✓



**BROCAS HSS-CO DIN-338 N MANGO REDUCIDO / FORETS EMBOUT REDUIT HSS-CO DIN 338 N / HSS-CO REDUCED SHANK DRILL DIN-338 N**  
**PUNTA HSS-CO DIN 338 N GAMBO RIDOTTO / BROCAS HSS-CO DIN-338 N HASTE REDUZIDA**

**HSS-CO**



ES Brocas de alto rendimiento, rectificadas, con contenido de cobalto, afilado en cruz y refuerzo total del alma. Mango reducido.  
 FR Foret pour fort rendement, rectifié avec de cobalt, aiguisé en croix et renforcement total. Embout réduit.  
 EN High-performance, contains cobalt, cross sharp point and totally reinforced body. Reduced shank.  
 IT Punta ad alto rendimento, rettificata, al cobalto, affilato a croce, con rinforzo totale dell'anima. Gambo ridotto.  
 PT Brocas de alto desempenho, retificadas, contendo cobalto, aguçadas em cruz e reforço total do interior. Haste reduzida.





Ref	Ø		
<b>0974 1350R</b>	13,50 mm	1	<b>27,85</b>
<b>0974 1400R</b>	14,00 mm	1	<b>26,73</b>
<b>0974 1450R</b>	14,50 mm	1	<b>36,98</b>
<b>0974 1500R</b>	15,00 mm	1	<b>37,64</b>
<b>0974 1550R</b>	15,50 mm	1	<b>43,25</b>
<b>0974 1600R</b>	16,00 mm	1	<b>45,08</b>
<b>0974 1650R</b>	16,50 mm	1	<b>51,10</b>
<b>0974 1700R</b>	17,00 mm	1	<b>51,10</b>
<b>0974 1750R</b>	17,50 mm	1	<b>52,22</b>
<b>0974 1800R</b>	18,00 mm	1	<b>61,30</b>
<b>0974 1850R</b>	18,50 mm	1	<b>67,73</b>
<b>0974 1900R</b>	19,00 mm	1	<b>67,73</b>
<b>0974 1950R</b>	19,50 mm	1	<b>75,99</b>
<b>0974 2000R</b>	20,00 mm	1	<b>86,90</b>

**BROCAS TITANIO HSS TIN-DIN 338 / FORETS TITANE HSS TIN-DIN 338 / HSS TIN-DIN 338 TWIST DRILLS**  
**PUNTA AL TITANIO HSS TIN-DIN 338 / BROCAS TITÂNIO HSS TIN-DIN 338**

**HSS-TIN**



ES Broca en acero rápido rectificadas, con recubrimiento de nitruro de titanio y afilada en cruz.  
 FR Foret en acier rapide rectifié, avec revêtement en nitrure de titane, aiguisé en croix.  
 EN High speed steel drill, titanium nitride coated and cross sharp point.  
 IT Punta in acciaio rapido rettificato, con rivestimento in nitruro di titanio, affilata a croce.  
 PT Broca de aço rápido retificado, com revestimento de nitreto de titânio e afiada em cruz.

Ref	Ø			Ref	Ø		
<b>0975 0100</b>	1,0 mm	10	<b>2,10</b>	<b>0975 0650</b>	6,5 mm	10	<b>4,20</b>
<b>0975 0150</b>	1,5 mm	10	<b>1,59</b>	<b>0975 0700</b>	7,0 mm	10	<b>5,62</b>
<b>0975 0200</b>	2,0 mm	10	<b>1,59</b>	<b>0975 0750</b>	7,5 mm	10	<b>6,09</b>
<b>0975 0225</b>	2,25 mm	10	<b>1,95</b>	<b>0975 0800</b>	8,0 mm	10	<b>6,43</b>
<b>0975 0250</b>	2,5 mm	10	<b>1,59</b>	<b>0975 0850</b>	8,5 mm	10	<b>7,41</b>
<b>0975 0300</b>	3,0 mm	10	<b>1,59</b>	<b>0975 0900</b>	9,0 mm	10	<b>8,06</b>
<b>0975 0325</b>	3,25 mm	10	<b>1,76</b>	<b>0975 0950</b>	9,5 mm	10	<b>9,13</b>
<b>0975 0350</b>	3,5 mm	10	<b>1,76</b>	<b>0975 1000</b>	10,0 mm	5	<b>10,16</b>
<b>0975 0400</b>	4,0 mm	10	<b>2,02</b>	<b>0975 1050</b>	10,5 mm	5	<b>11,74</b>
<b>0975 0425</b>	4,25 mm	10	<b>2,41</b>	<b>0975 1100</b>	11,0 mm	5	<b>13,12</b>
<b>0975 0450</b>	4,5 mm	10	<b>2,41</b>	<b>0975 1150</b>	11,5 mm	5	<b>14,56</b>
<b>0975 0500</b>	5,0 mm	10	<b>2,57</b>	<b>0975 1200</b>	12,0 mm	5	<b>16,76</b>
<b>0975 0525</b>	5,25 mm	10	<b>3,09</b>	<b>0975 1250</b>	12,5 mm	5	<b>17,65</b>
<b>0975 0550</b>	5,5 mm	10	<b>3,09</b>	<b>0975 1300</b>	13,0 mm	5	<b>19,33</b>
<b>0975 0600</b>	6,0 mm	10	<b>3,43</b>				



BROCAS ESPECIALES HSS-CO PARA ACERO INOXIDABLE / FORETS ACIER INOXIDABLE / STAINLESS STEEL DRILLS  
PUNTE SPECIALI PER ACCIAIO INOSSIDABILE / BROCAS ESPECIAIS HSS-CO PARA AÇO INOXIDÁVEL

HSS-CO

135°

INOX



ES Brocas de alto rendimiento en acero rápido, con un 5% de cobalto, punta de 135°, afilado en cruz, sistema Split point y espiral continua IX.  
FR Foret pour rendement en acier rapide avec 5% de Cobalt, embout de 135°, aiguisé en croix, système. Split point avec spirale continue IX.  
EN High performance drills, 5% CO, 135° point, cross sharpened. Split point system and stainless spiral.  
IT Punta ad alto rendimento in acciaio rapido con il 5% di cobalto, punta a 135°, affilatura a croce con spirale continua IX.  
PT Brocas de alto desempenho, em aço rápido com 5% de cobalto, ponta 135°, afiada em cruz, sistema. Split point e com espiral contínua IX.

Ref	Ø	📦	📦
0982 0300	3,0 mm	10	3,09
0982 0350	3,5 mm	10	3,34
0982 0400	4,0 mm	10	3,81
0982 0450	4,5 mm	10	4,42
0982 0500	5,0 mm	10	4,67
0982 0550	5,5 mm	10	5,66
0982 0600	6,0 mm	10	6,26
0982 0650	6,5 mm	10	7,46
0982 0700	7,0 mm	10	8,66
0982 0750	7,5 mm	10	9,90
0982 0800	8,0 mm	10	10,71

Ref	Ø	📦	📦
0982 0850	8,5 mm	10	12,94
0982 0900	9,0 mm	10	14,01
0982 0950	9,5 mm	10	15,85
0982 1000	10,0 mm	5	17,44
0982 1050	10,5 mm	5	20,65
0982 1100	11,0 mm	5	22,09
0982 1150	11,5 mm	5	26,60
0982 1200	12,0 mm	5	25,84
0982 1250	12,5 mm	5	32,39
0982 1300	13,0 mm	5	32,39

HSS-CO

135°

INOX



Ref	Ø	📦	📦	📦
0982 0300BL	3,00 mm	1 blister x 2 uds	7,37	✓
0982 0350BL	3,50 mm	1 blister x 2 uds	7,94	✓
0982 0400BL	4,00 mm	1 blister x 1 uds	4,76	✓
0982 0450BL	4,50 mm	1 blister x 1 uds	5,45	✓
0982 0500BL	5,00 mm	1 blister x 1 uds	5,70	✓
0982 0550BL	5,50 mm	1 blister x 1 uds	6,77	✓
0982 0600BL	6,00 mm	1 blister x 1 uds	7,46	✓
0982 0650BL	6,50 mm	1 blister x 1 ud	8,78	✓
0982 0700BL	7,00 mm	1 blister x 1 ud	10,07	✓
0982 0750BL	7,50 mm	1 blister x 1 ud	11,40	✓
0982 0800BL	8,00 mm	1 blister x 1 ud	12,34	✓
0982 0850BL	8,50 mm	1 blister x 1 ud	14,74	✓
0982 0900BL	9,00 mm	1 blister x 1 ud	15,94	✓
0982 1000BL	10,00 mm	1 blister x 1 ud	19,66	✓
0982 1100BL	11,00 mm	1 blister x 1 ud	24,68	✓
0982 1200BL	12,00 mm	1 blister x 1 ud	28,83	✓
0982 1300BL	13,00 mm	1 blister x 1 ud	36,03	✓



BROCAS MANGO CÓNICO HSS-DIN 345N / FORETS EMBOUT CÔNE MORSE HSS-DIN 345N / MORSE TAPER SHANK TWIST DRILLS HSS-DIN 345N  
 PUNTA A GAMBO CONICO HSS-DIN 345N / BROCAS HASTE CÔNICA HSS-DIN 345N

**HSS**



Ref	Ø	↔	P			
0968 1000	10 mm	168 mm	87 mm	1	1	15,56
0968 1050	10,5 mm	168 mm	87 mm	1	1	16,67
0968 1100	11 mm	175 mm	94 mm	1	1	16,27
0968 1150	11,5 mm	175 mm	94 mm	1	1	17,15
0968 1200	12 mm	182 mm	101 mm	1	1	17,56
0968 1250	12,5 mm	182 mm	101 mm	1	1	19,54
0968 1300	13 mm	182 mm	101 mm	1	1	19,54
0968 1350	13,5 mm	189 mm	108 mm	1	1	20,55
0968 1400	14 mm	189 mm	108 mm	1	1	21,47
0968 1450	14,5 mm	212 mm	114 mm	2	1	23,27
0968 1500	15 mm	212 mm	114 mm	2	1	23,27
0968 1550	15,5 mm	218 mm	120 mm	2	1	24,03
0968 1600	16 mm	218 mm	120 mm	2	1	24,03
0968 1650	16,5 mm	223 mm	125 mm	2	1	27,20
0968 1700	17 mm	223 mm	125 mm	2	1	27,20
0968 1750	17,5 mm	228 mm	130 mm	2	1	30,08
0968 1800	18 mm	228 mm	130 mm	2	1	30,08
0968 1850	18,5 mm	233 mm	135 mm	2	1	33,12
0968 1900	19 mm	233 mm	135 mm	2	1	33,12
0968 1950	19,5 mm	238 mm	140 mm	2	1	36,04
0968 2000	20 mm	238 mm	140 mm	2	1	36,04
0968 2050	20,5 mm	243 mm	145 mm	2	1	38,94
0968 2100	21 mm	243 mm	145 mm	2	1	38,94
0968 2150	21,5 mm	248 mm	150 mm	2	1	41,20
0968 2200	22 mm	248 mm	150 mm	2	1	43,00
0968 2250	22,5 mm	253 mm	155 mm	2	1	45,02
0968 2300	23 mm	253 mm	155 mm	3	1	47,04
0968 2350	23,5 mm	276 mm	155 mm	3	1	49,70
0968 2400	24 mm	281 mm	160 mm	3	1	51,93
0968 2450	24,5 mm	281 mm	160 mm	3	1	56,60
0968 2500	25 mm	281 mm	160 mm	3	1	56,60
0968 2550	25,5 mm	286 mm	165 mm	3	1	58,92

Ref	Ø	↔	P			
0968 2600	26 mm	286 mm	165 mm	3	1	61,57
0968 2650	26,5 mm	286 mm	165 mm	3	1	63,85
0968 2700	27 mm	291 mm	170 mm	3	1	65,60
0968 2750	27,5 mm	291 mm	170 mm	3	1	68,35
0968 2800	28 mm	291 mm	170 mm	3	1	71,41
0968 2850	28,5 mm	296 mm	175 mm	3	1	76,06
0968 2900	29 mm	296 mm	175 mm	3	1	76,56
0968 2950	29,5 mm	296 mm	175 mm	3	1	80,90
0968 3000	30 mm	296 mm	175 mm	3	1	84,23
0968 3050	30,5 mm	301 mm	180 mm	3	1	116,83
0968 3100	31 mm	301 mm	180 mm	3	1	96,76
0968 3150	31,5 mm	301 mm	180 mm	3	1	111,90
0968 3200	32 mm	334 mm	185 mm	4	1	99,22
0968 3300	33 mm	334 mm	185 mm	4	1	113,31
0968 3400	34 mm	339 mm	190 mm	4	1	123,26
0968 3500	35 mm	339 mm	190 mm	4	1	134,69
0968 3600	36 mm	344 mm	195 mm	4	1	144,50
0968 3700	37 mm	344 mm	195 mm	4	1	145,80
0968 3800	38 mm	349 mm	200 mm	4	1	153,50
0968 3900	39 mm	349 mm	200 mm	4	1	163,60
0968 4000	40 mm	349 mm	200 mm	4	1	180,45
0968 4100	41 mm	354 mm	205 mm	4	1	189,74
0968 4200	42 mm	354 mm	205 mm	4	1	196,51
0968 4300	43 mm	359 mm	210 mm	4	1	206,13
0968 4400	44 mm	359 mm	210 mm	4	1	215,79
0968 4500	45 mm	359 mm	210 mm	4	1	224,07
0968 4600	46 mm	364 mm	215 mm	4	1	234,77
0968 4700	47 mm	364 mm	215 mm	4	1	244,39
0968 4800	48 mm	369 mm	220 mm	4	1	252,63
0968 4900	49 mm	369 mm	220 mm	4	1	262,33
0968 5000	50 mm	369 mm	220 mm	4	1	264,56

BROCAS MANGO CÓNICO COBALTO HSS-CO DIN 345N / FORETS EMBOUT CÔNE MORSE COBALT HSS-CO DIN 345N  
 MORSE TAPER SHANK TWIST DRILLS HSS-CO DIN 345N / PUNTA A GAMBO CONICO HSS-DIN 345N / BROCAS HASTE CÔNICA COBALTO HSS-DIN 345N

**HSS-CO**



Ref	Ø	↔	P			
0969 1000	10 mm	168 mm	87 mm	1	1	38,35
0969 1050	10,5 mm	168 mm	87 mm	1	1	46,58
0969 1100	11 mm	175 mm	94 mm	1	1	39,52
0969 1150	11,5 mm	175 mm	94 mm	1	1	43,83
0969 1200	12 mm	182 mm	101 mm	1	1	38,39
0969 1250	12,5 mm	182 mm	101 mm	1	1	38,51
0969 1300	13 mm	182 mm	101 mm	1	1	40,40
0969 1350	13,5 mm	189 mm	108 mm	1	1	40,91
0969 1400	14 mm	189 mm	108 mm	1	1	45,58
0969 1450	14,5 mm	212 mm	114 mm	2	1	69,84
0969 1500	15 mm	212 mm	114 mm	2	1	70,34
0969 1550	15,5 mm	218 mm	120 mm	2	1	73,64
0969 1600	16 mm	218 mm	120 mm	2	1	73,40
0969 1650	16,5 mm	223 mm	125 mm	2	1	73,64
0969 1700	17 mm	223 mm	125 mm	2	1	73,98
0969 1750	17,5 mm	228 mm	130 mm	2	1	77,33
0969 1800	18 mm	228 mm	130 mm	2	1	76,27
0969 1850	18,5 mm	233 mm	135 mm	2	1	79,42
0969 1900	19 mm	233 mm	135 mm	2	1	85,60
0969 1950	19,5 mm	238 mm	140 mm	2	1	85,98
0969 2000	20 mm	238 mm	140 mm	2	1	91,42
0969 2050	20,5 mm	243 mm	145 mm	2	1	99,99
0969 2100	21 mm	243 mm	145 mm	2	1	108,35
0969 2150	21,5 mm	248 mm	150 mm	2	1	116,84
0969 2200	22 mm	248 mm	150 mm	2	1	117,55
0969 2250	22,5 mm	253 mm	155 mm	2	1	131,85

Ref	Ø	↔	P			
0969 2300	23 mm	253 mm	155 mm	3	1	128,30
0969 2350	23,5 mm	276 mm	155 mm	3	1	125,75
0969 2400	24 mm	281 mm	160 mm	3	1	125,62
0969 2450	24,5 mm	281 mm	160 mm	3	1	138,13
0969 2500	25 mm	281 mm	160 mm	3	1	136,08
0969 2550	25,5 mm	286 mm	165 mm	3	1	148,26
0969 2600	26 mm	286 mm	165 mm	3	1	150,67
0969 2650	26,5 mm	286 mm	165 mm	3	1	158,33
0969 2700	27 mm	291 mm	170 mm	3	1	160,80
0969 2750	27,5 mm	291 mm	170 mm	3	1	170,21
0969 2800	28 mm	291 mm	170 mm	3	1	172,88
0969 2850	28,5 mm	296 mm	175 mm	3	1	182,04
0969 2900	29 mm	296 mm	175 mm	3	1	186,39
0969 2950	29,5 mm	296 mm	175 mm	3	1	195,00
0969 3000	30 mm	296 mm	175 mm	3	1	198,48
0969 3100	31 mm	301 mm	180 mm	3	1	193,96
0969 3200	32 mm	334 mm	185 mm	4	1	212,70
0969 3300	33 mm	334 mm	185 mm	4	1	236,40
0969 3400	34 mm	339 mm	190 mm	4	1	252,09
0969 3500	35 mm	339 mm	190 mm	4	1	262,42
0969 3600	36 mm	344 mm	195 mm	4	1	292,12
0969 3700	37 mm	344 mm	195 mm	4	1	280,69
0969 3800	38 mm	349 mm	200 mm	4	1	319,37
0969 3900	39 mm	349 mm	200 mm	4	1	347,23
0969 4000	40 mm	349 mm	200 mm	4	1	361,28





MALETINES SURTIDOS DE BROCAS / CAISSE DE FORETS / DRILL CASE / CASSETTA PORTA PUNTE / MALETAS SORTIDAS DE BROCAS

HSS



HSS-CO



HSS-TIN



☐	HSS	HSS-CO	HSS-TIN
∅	0401 0973	0401 0974	0401 0975
1,00 mm	20 pcs	10 pcs	10 pcs
1,50 mm	10 pcs	5 pcs	5 pcs
2,00 mm	20 pcs	10 pcs	10 pcs
2,50 mm	10 pcs	5 pcs	5 pcs
3,00 mm	20 pcs	10 pcs	10 pcs
3,50 mm	10 pcs	5 pcs	5 pcs
4,00 mm	20 pcs	10 pcs	10 pcs
4,50 mm	10 pcs	5 pcs	5 pcs
5,00 mm	20 pcs	10 pcs	10 pcs
5,50 mm	10 pcs	5 pcs	5 pcs
6,00 mm	20 pcs	10 pcs	10 pcs
6,50 mm	10 pcs	5 pcs	5 pcs
7,00 mm	10 pcs	5 pcs	5 pcs
7,50 mm	10 pcs	5 pcs	5 pcs
8,00 mm	10 pcs	5 pcs	5 pcs
8,50 mm	10 pcs	5 pcs	5 pcs
9,00 mm	10 pcs	5 pcs	5 pcs
9,50 mm	10 pcs	5 pcs	5 pcs
10,00 mm	10 pcs	5 pcs	5 pcs
TOTAL	250 pcs	125 pcs	125 pcs
📦	<b>450,55</b>	<b>408,98</b>	<b>522,14</b>

Vacío / Empty / Vide / Vuota / Vazio	Ref	☐	📦
	<b>0400 0020</b>	1	<b>63,86</b>

MALETINES SURTIDOS DE BROCAS / COFFRET FORETS / TWIST DRILL SETS / ASTUCCIO PUNTE / MALETAS SORTIDAS DE BROCAS



Ref	MODEL	☐	☐	📦	📦
<b>0973 1141</b>	HSS	1 - 1,5 - 2 - 2,5 - 3 - 3,5 - 4 - 4,5 - 5 - 5,5 - 6 - 6,5	19 pcs	1	<b>45,67</b>
<b>0974 1141</b>	HSS-CO	7 - 7,5 - 8 - 8,5 - 9 - 9,5 - 10 mm	19 pcs	1	<b>72,74</b>
<b>0975 1141</b>	HSS-TIN		19 pcs	1	<b>92,01</b>

Ref	MODEL	☐	☐	📦	📦
<b>0973 1142</b>	HSS	1 - 1,5 - 2 - 2,5 - 3 - 3,5 - 4 - 4,5 - 5 - 5,5 - 6 - 6,5 - 7 - 7,5	25 pcs	1	<b>89,20</b>
<b>0974 1142</b>	HSS-CO	8 - 8,5 - 9 - 9,5 - 10 - 10,5 - 11 - 11,5 - 12 - 12,5 - 13 mm	25 pcs	1	<b>168,15</b>
<b>0975 1142</b>	HSS-TIN		25 pcs	1	<b>189,66</b>





**BROCAS PERCUTORAS ESTÁNDAR PARA MUROS / FORET A PERCUSSION BETON STANDARD / STANDARD CONCRETE TWIST DRILL  
PUNTA A PERCUSSIONE DA MURO, STANDARD / BROCA DE PERCUSSÃO STANDARD PARA BETÃO**



ES Broca de percusión y rotación con cuerpo laminado en frío en forma semirredonda y plaquita de carburo al tungsteno.

FR Forêt à percussion béton standard. Pointe 2 dents. Percussion et rotation.

EN Standard concrete twist drills. Sheet body and semi-round shape.

IT Punta a percussione e rotazione con corpo laminato a freddo di forma semirotonda e inserto al carburo di tungsteno.

PT Broca de percussão e rotação com corpo laminado a frio, semi-redonda, carboneto de tungstênio.

Ref	Ø	↔	📦	📊	📄
0984 0300	3 mm	60 mm	1	0,91	✓
0984 0400	4 mm	75 mm	1	0,91	✓
0984 0500	5 mm	85 mm	1	0,91	✓
0984 0600	6 mm	100 mm	1	0,91	✓
0984 0700	7 mm	100 mm	1	1,12	✓
0984 0800	8 mm	120 mm	1	1,34	✓
0984 0900	9 mm	120 mm	1	1,59	✓
0984 1000	10 mm	120 mm	1	1,93	✓
0984 1100	11 mm	150 mm	1	2,23	✓
0984 1200	12 mm	150 mm	1	2,49	✓
0984 1300	13 mm	150 mm	1	3,64	✓
0984 1400	14 mm	150 mm	1	4,12	✓
0984 1500	15 mm	150 mm	1	4,93	✓
0984 1600	16 mm	150 mm	1	5,40	✓
0984 1800	18 mm	160 mm	1	7,07	✓
0984 2000	20 mm	160 mm	1	9,69	✓

**BROCA PERCUTORA PARA MUROS ESTÁNDAR EXTRA LARGA / FORET À PERCUSSION POUR MURS STANDARD PLUS LONG  
STANDARD CONCRETE TWIST DRILLS LONG SERIES / PUNTA A PERCUSSIONE DA MURO, STANDARD EXTRA LUNGA  
BROCA DE PERCUSSÃO STANDARD PARA BETÃO EXTRA LONGA**



ES Broca de percusión y rotación con cuerpo laminado en frío en forma semirredonda y plaquita de carburo al tungsteno.

FR Forêt à percussion béton standard. Pointe 2 dents. Percussion et rotation.

EN Standard concrete twist drills. Sheet body and semi-round shape.

IT Punta a percussione e rotazione con corpo laminato a freddo di forma semirotonda e inserto al carburo di tungsteno.

PT Broca de percussão e rotação com corpo laminado a frio, semi-redonda, carboneto de tungstênio.

Ref	Ø	↔	📦	📊	📄
0985 06200	6 mm	200 mm	1	3,32	✓
0985 06300	6 mm	300 mm	1	4,44	✓
0985 06400	6 mm	400 mm	1	5,15	✓
0985 08200	8 mm	200 mm	1	3,93	✓
0985 08300	8 mm	300 mm	1	4,99	✓
0985 08400	8 mm	400 mm	1	5,56	✓
0985 10300	10 mm	300 mm	1	4,99	✓
0985 10400	10 mm	400 mm	1	6,07	✓
0985 12300	12 mm	300 mm	1	5,89	✓
0985 12400	12 mm	400 mm	1	6,99	✓
0985 14300	14 mm	300 mm	1	7,25	✓
0985 14400	14 mm	400 mm	1	7,82	✓
0985 16300	16 mm	300 mm	1	10,23	✓
0985 16400	16 mm	400 mm	1	10,99	✓
0985 18300	18 mm	300 mm	1	11,82	✓
0985 18400	18 mm	400 mm	1	13,03	✓
0985 20300	20 mm	300 mm	1	15,94	✓
0985 20400	20 mm	400 mm	1	17,96	✓



BROCAS PERCUTORAS PROFESIONAL PARA MUROS / FORET A PERCUSSION BETON PROFESSIONNEL / PROFESSIONAL CONCRETE TWIST DRILLS  
PUNTA A PERCUSSIONE DA MURO, PROFESSIONALE / BROCA DE PERCUSSÃO PROFISSIONAL PARA BETÃO



ES Broca de percusión y rotación con cuerpo fresado en forma de U, punta 2 cortes, soldada a 1100° con punta centradora y con labio saliente para evitar vibraciones en el taladro.

FR Foret percussion et rotations avec corps fraisé en forme de U et plaque de carbure rectifiée au diamant. Embout central avec bec saillant pour éviter toute vibration de la perceuse.

EN Impact and rotation drill with U type milling, 2-cuts tip, welded at 1100° with centring tip to avoid vibration of drill machine.

IT Punta a percussione e rotazione con fresatura del corpo a forma di U. Inserto in carburo rettificato al diamante. Punta di centraggio per evitare vibrazioni nel trapano.

PT Broca de percussão e rotação com corpo de fresagem com forma de U, ponta 2 cortes, soldadas em 1100 ° com ponta de centrar com saliência para evitar vibrações na broca.

Ref	Ø	↔	P	📦	📌	Ref	Ø	↔	P	📦	📌
0977 0370	3 mm	70 mm	40 mm	2,26	✓	0977 10400	10 mm	400 mm	350 mm	11,88	✓
0977 3570	3,5 mm	70 mm	40 mm	2,30	✓	0977 11150	11 mm	150 mm	90 mm	5,53	✓
0977 0475	4 mm	75 mm	40 mm	2,19	✓	0977 12150	12 mm	150 mm	90 mm	6,17	✓
0977 4580	4,5 mm	80 mm	50 mm	2,30	✓	0977 12300	12 mm	300 mm	250 mm	8,82	✓
0977 0585	5 mm	85 mm	50 mm	2,19	✓	0977 12400	12 mm	400 mm	350 mm	14,13	✓
0977 05150	5 mm	150 mm	90 mm	3,08	✓	0977 13150	13 mm	150 mm	90 mm	7,58	✓
0977 5585	5,5 mm	85 mm	50 mm	2,29	✓	0977 14150	14 mm	160 mm	100 mm	9,35	✓
0977 06100	6 mm	100 mm	60 mm	2,48	✓	0977 14300	14 mm	300 mm	250 mm	16,01	✓
0977 06150	6 mm	150 mm	90 mm	3,42	✓	0977 14400	14 mm	400 mm	350 mm	18,05	✓
0977 65100	6,5 mm	100 mm	60 mm	2,92	✓	0977 15160	15 mm	160 mm	100 mm	10,79	✓
0977 07100	7 mm	100 mm	60 mm	2,74	✓	0977 16160	16 mm	160 mm	100 mm	12,05	✓
0977 08120	8 mm	120 mm	80 mm	2,96	✓	0977 16400	16 mm	400 mm	350 mm	21,27	✓
0977 08200	8 mm	200 mm	150 mm	5,51	✓	0977 18160	18 mm	160 mm	100 mm	15,97	✓
0977 08400	8 mm	400 mm	350 mm	11,37	✓	0977 18400	18 mm	400 mm	350 mm	23,36	✓
0977 09120	9 mm	120 mm	80 mm	3,39	✓	0977 20160	20 mm	160 mm	100 mm	19,07	✓
0977 10120	10 mm	120 mm	80 mm	4,24	✓	0977 20400	20 mm	400 mm	350 mm	27,64	✓
0977 10200	10 mm	200 mm	150 mm	6,63	✓	0977 22160	22 mm	160 mm	100 mm	21,93	✓

BROCAS PERCUTORAS PROFESIONAL PARA MUROS / FORET A PERCUSSION BETON PROFESSIONNEL / PROFESSIONAL CONCRETE TWIST DRILLS  
PUNTA A PERCUSSIONE DA MURO, PROFESSIONALE / BROCA DE PERCUSSÃO PROFISSIONAL PARA BETÃO



Ref	Ø	↔	📦	📌	📌
6240 0470	4 mm	70 mm	1 blister x 1 ud	2,51	✓
6240 0580	5 mm	80 mm	1 blister x 1 ud	2,89	✓
6240 0610	6 mm	100 mm	1 blister x 1 ud	3,30	✓
6240 0710	7 mm	100 mm	1 blister x 1 ud	3,80	✓
6240 0812	8 mm	120 mm	1 blister x 1 ud	4,02	✓
6240 0912	9 mm	120 mm	1 blister x 1 ud	3,72	✓
6240 1012	10 mm	120 mm	1 blister x 1 ud	4,81	✓
6240 1115	11 mm	150 mm	1 blister x 1 ud	6,53	✓
6240 1215	12 mm	150 mm	1 blister x 1 ud	7,19	✓
6240 1315	13 mm	150 mm	1 blister x 1 ud	9,16	✓

JUEGOS DE BROCAS PARA MUROS PROFESIONAL / JEU DE FORETS A PERCUSSION POUR LE BETON  
CONCRETE TWIST DRILL SETS / SET PUNTE DA MURO PROFESSIONALI / JOGOS DE BROCAS DE PERCUSSÃO PROFISSIONAL PARA BETÃO



Ref	↓	↓	📦	📌
0977 0002	4, 5, 6, 8, 10 mm	5 pcs	1	18,19
0977 0003	3, 4, 5, 6, 7, 8, 9, 10 mm	8 pcs	1	27,65



BROCA PROFESIONAL PARA MUROS MANGO HEX. 1/4" / FORET PROFESSIONNEL POUR LES MÛRS MANCHE HEX. 1/4"  
PROFESSIONAL WALL DRILL BIT WITH 1/4" HEXAGONAL HANDLE / PUNTA PROFESSIONALE PER MURI, MANICO ESAGONALE 1/4"  
BROCA PROFISSIONAL PARA BETÃO, HASTE HEX. 1/4"



ES Broca para muros de mango hexagonal de 1/4", con punta de doble corte soldada a 1100°. Aplicaciones: Rotación y percusión en hormigón, ladrillo gres, cerámica y mármol.

FR Forêt pour les murs avec manche hexagonal de 1/4", avec pointe de double coupe soudée à 1100°. Applications: Rotation et percussion en béton, brique, grès, céramique et marbre.

EN Wall drill bit with a 1/4" hexagonal handle and with a double cut point welded a 1100°. Application: Rotation and percussion in concrete, bricks, ceramics and marble.

IT Punta per muri, manico esagonale da 1/4", con punta doppio taglio saldata a 1100°. Applicazioni: Rotazione e percussione su calcestruzzo, porcellanato gres, ceramica, marmo.

PT Brocas para betão de haste hexagonal de 1/4", com ponta de duplo corte, soldada a 1100°. Aplicação: rotação e percussão em betão, azulejo, grés, cerâmica e mármore.

Ref	Ø			
0977 5003	3 mm	1	2,50	✓
0977 5004	4 mm	1	2,65	✓
0977 5005	5 mm	1	3,31	✓
0977 5006	6 mm	1	3,67	✓
0977 5007	7 mm	1	3,98	✓
0977 5008	8 mm	1	4,33	✓
0977 5009	9 mm	1	5,00	✓
0977 5010	10 mm	1	5,51	✓
0977 5012	12 mm	1	6,63	✓

BROCAS PERCUTORAS PROFESIONAL ESPECIAL GRANITO Y MATERIALES DUROS / FORET À PERCUSSION GRANIT PROFESSIONNEL  
PROFESSIONAL GRANITE TWIST DRILLS / PUNTA A PERCUSSIONE PROFESSIONALE PER GRANITO E MATERIALI DURI  
BROCAS DE PERCUSSÃO PROFISSIONAL ESPECIAL GRANITO E MATERIAIS DUROS

GRANITO



Ref	Ø	↔	P			
0970 0300	3,0 mm	70 mm	35 mm	1	2,68	✓
0970 0400	4,0 mm	75 mm	40 mm	1	2,68	✓
0970 0500	5,0 mm	85 mm	50 mm	1	2,75	✓
0970 0600	6,0 mm	100 mm	60 mm	1	3,16	✓
0970 0700	7,0 mm	100 mm	60 mm	1	3,57	✓
0970 0800	8,0 mm	120 mm	70 mm	1	3,93	✓
0970 0900	9,0 mm	120 mm	70 mm	1	4,50	✓
0970 1000	10,0 mm	120 mm	80 mm	1	5,25	✓
0970 1100	11,0 mm	150 mm	80 mm	1	8,05	✓
0970 1200	12,0 mm	150 mm	80 mm	1	8,40	✓
0970 1300	13,0 mm	150 mm	80 mm	1	10,69	✓
0970 1400	14,0 mm	150 mm	80 mm	1	11,42	✓
0970 1600	16,0 mm	160 mm	80 mm	1	14,74	✓
0970 1800	18,0 mm	160 mm	80 mm	1	20,51	✓
0970 2000	20,0 mm	160 mm	80 mm	1	24,52	✓

Extra Larga  
Long Series

Ref	Ø	↔	P			
0970 0600XL	6,0 mm	150 mm	80 mm	1	4,18	✓
0970 0800XL	8,0 mm	250 mm	170 mm	1	6,59	✓
0970 1000XL	10,0 mm	250 mm	170 mm	1	8,31	✓
0970 1200XL	12,0 mm	250 mm	170 mm	1	11,27	✓
0970 1400XL	14,0 mm	250 mm	170 mm	1	21,47	✓

JUEGOS DE BROCAS PROFESIONALES ESPECIAL PARA GRANITO / JEU DE FORETS A PERCUSSION POUR GRANIT / GRANITE TWIST DRILL SETS  
SET PUNTE PROFESSIONALI SPECIALI PER GRANITO / JOGOS DE BROCAS PROFISSIONAIS, ESPECIAL PARA GRANITO

GRANITO

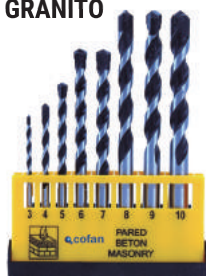

Ref				
0970 9998	4, 5, 6, 8, 10 mm	5 pcs	1	21,32
0970 9999	3, 4, 5, 6, 7, 8, 9, 10 mm	8 pcs	1	31,70



**BROCAS PERCUTORAS SDS PLUS PARA MUROS / FORETS SDS PLUS BÉTON / ROTARY HAMMER DRILL BIT WITH SDS PLUS SHANK  
PUNTA SDS PLUS DA MURO / BROCAS DE PERCUSSÃO SDS PLUS PARA BETÃO**



Ref	Ø	↔	P	📦	📊	📄
0978 04110	4 mm	110 mm	50 mm	1	5,08	✓
0978 05110	5 mm	110 mm	50 mm	1	4,47	✓
0978 05160	5 mm	160 mm	100 mm	1	5,41	✓
0978 55160	5,5 mm	160 mm	100 mm	1	4,63	✓
0978 06110	6 mm	110 mm	50 mm	1	4,59	✓
0978 06160	6 mm	160 mm	100 mm	1	4,67	✓
0978 06210	6 mm	210 mm	150 mm	1	7,17	✓
0978 06260	6 mm	260 mm	200 mm	1	11,07	✓
0978 06310	6 mm	310 mm	250 mm	1	14,31	✓
0978 65160	6,5 mm	160 mm	100 mm	1	5,04	✓
0978 07110	7 mm	110 mm	50 mm	1	4,88	✓
0978 07160	7 mm	160 mm	100 mm	1	5,41	✓
0978 08110	8 mm	110 mm	50 mm	1	4,84	✓
0978 08160	8 mm	160 mm	100 mm	1	4,96	✓
0978 08210	8 mm	210 mm	150 mm	1	6,11	✓
0978 08260	8 mm	260 mm	200 mm	1	8,36	✓
0978 08610	8 mm	610 mm	550 mm	1	37,31	✓
0978 09160	9 mm	160 mm	100 mm	1	6,23	✓
0978 09210	9 mm	210 mm	150 mm	1	8,08	✓
0978 10110	10 mm	110 mm	50 mm	1	5,12	✓
0978 10160	10 mm	160 mm	100 mm	1	6,19	✓
0978 10210	10 mm	210 mm	150 mm	1	8,08	✓
0978 10260	10 mm	260 mm	200 mm	1	9,02	✓
0978 10610	10 mm	610 mm	550 mm	1	32,10	✓
0978 101000	10 mm	1000 mm	940 mm	1	105,04	✓
0978 11160	11 mm	160 mm	100 mm	1	7,46	✓
0978 11260	11 mm	260 mm	200 mm	1	11,19	✓
0978 12160	12 mm	160 mm	100 mm	1	7,13	✓
0978 12210	12 mm	210 mm	150 mm	1	9,84	✓
0978 12260	12 mm	260 mm	200 mm	1	11,15	✓
0978 12610	12 mm	610 mm	550 mm	1	38,17	✓

Ref	Ø	↔	P	📦	📊	📄
0978 121000	12 mm	1000 mm	940 mm	1	109,92	✓
0978 13160	13 mm	160 mm	100 mm	1	11,60	✓
0978 13210	13 mm	210 mm	150 mm	1	12,96	✓
0978 13260	13 mm	260 mm	200 mm	1	14,06	✓
0978 13610	13 mm	610 mm	550 mm	1	30,69	✓
0978 14160	14 mm	160 mm	100 mm	1	11,60	✓
0978 14210	14 mm	210 mm	150 mm	1	12,83	✓
0978 14260	14 mm	260 mm	200 mm	1	13,37	✓
0978 14610	14 mm	610 mm	550 mm	1	37,68	✓
0978 141000	14 mm	1000 mm	940 mm	1	109,92	✓
0978 15160	15 mm	160 mm	100 mm	1	14,80	✓
0978 15260	15 mm	260 mm	200 mm	1	16,65	✓
0978 16210	16 mm	210 mm	150 mm	1	15,13	✓
0978 16260	16 mm	260 mm	200 mm	1	16,65	✓
0978 16610	16 mm	610 mm	550 mm	1	39,69	✓
0978 161000	16 mm	1000 mm	940 mm	1	135,79	✓
0978 17210	17 mm	210 mm	150 mm	1	21,52	✓
0978 18210	18 mm	210 mm	150 mm	1	21,52	✓
0978 18610	18 mm	610 mm	550 mm	1	47,27	✓
0978 181000	18 mm	1000 mm	940 mm	1	145,47	✓
0978 20210	20 mm	210 mm	150 mm	1	28,95	✓
0978 20610	20 mm	610 mm	550 mm	1	58,01	✓
0978 201000	20 mm	1000 mm	940 mm	1	130,09	✓
0978 22260	22 mm	260 mm	200 mm	1	42,89	✓
0978 22610	22 mm	610 mm	550 mm	1	58,05	✓
0978 221000	22 mm	1000 mm	940 mm	1	171,34	✓
0978 24260	24 mm	260 mm	200 mm	1	48,22	✓
0978 25260	25 mm	260 mm	200 mm	1	50,27	✓
0978 251000	25 mm	1000 mm	940 mm	1	201,19	✓

**BROCAS SDS PLUS PARA MUROS 4 PUNTAS / FORETS SDS PLUS - BETON / ROTARY HAMMER DRILL BIT WITH SDS PLUS SHANK  
PUNTA SDS PLUS DA MURO / BROCAS SDS PLUS PARA BETÃO 4 PONTAS**



Ref	Ø	↔	P	📦	📊	📄
0967 05110	5,0 mm	110 mm	50 mm	1	5,14	✓
0967 05160	5,0 mm	160 mm	100 mm	1	6,09	✓
0967 06110	6,0 mm	110 mm	50 mm	1	6,81	✓
0967 06160	6,0 mm	160 mm	100 mm	1	7,50	✓
0967 06210	6,0 mm	210 mm	150 mm	1	10,07	✓
0967 06265	6,0 mm	265 mm	200 mm	1	12,55	✓
0967 08110	8,0 mm	110 mm	50 mm	1	8,95	✓
0967 08160	8,0 mm	160 mm	100 mm	1	9,13	✓
0967 08210	8,0 mm	210 mm	150 mm	1	11,22	✓
0967 08265	8,0 mm	265 mm	200 mm	1	12,81	✓
0967 08315	8,0 mm	315 mm	250 mm	1	16,32	✓
0967 08465	8,0 mm	465 mm	400 mm	1	27,03	✓
0967 10110	10,0 mm	110 mm	50 mm	1	10,16	✓
0967 10160	10,0 mm	160 mm	100 mm	1	10,88	✓
0967 10210	10,0 mm	210 mm	150 mm	1	12,98	✓
0967 10265	10,0 mm	265 mm	200 mm	1	17,35	✓
0967 10315	10,0 mm	315 mm	250 mm	1	22,06	✓
0967 10465	10,0 mm	465 mm	400 mm	1	30,29	✓
0967 12160	12,0 mm	160 mm	100 mm	1	13,49	✓
0967 12210	12,0 mm	210 mm	150 mm	1	16,12	✓

Ref	Ø	↔	P	📦	📊	📄
0967 12265	12,0 mm	265 mm	200 mm	1	20,31	✓
0967 12315	12,0 mm	315 mm	250 mm	1	26,35	✓
0967 12465	12,0 mm	465 mm	400 mm	1	32,94	✓
0967 14210	14,0 mm	210 mm	150 mm	1	20,94	✓
0967 14265	14,0 mm	265 mm	200 mm	1	24,33	✓
0967 14315	14,0 mm	315 mm	250 mm	1	31,18	✓
0967 14465	14,0 mm	465 mm	400 mm	1	39,07	✓
0967 16250	16,0 mm	250 mm	200 mm	1	46,14	✓
0967 16315	16,0 mm	315 mm	250 mm	1	42,15	✓
0967 16450	16,0 mm	450 mm	400 mm	1	54,32	✓
0967 18250	18,0 mm	250 mm	200 mm	1	55,55	✓
0967 18450	18,0 mm	450 mm	400 mm	1	65,23	✓
0967 20250	20,0 mm	250 mm	200 mm	1	62,73	✓
0967 20450	20,0 mm	450 mm	400 mm	1	74,82	✓
0967 22250	22,0 mm	250 mm	200 mm	1	72,98	✓
0967 22450	22,0 mm	450 mm	400 mm	1	90,06	✓
0967 24450	24,0 mm	450 mm	400 mm	1	95,37	✓
0967 25450	25,0 mm	450 mm	400 mm	1	96,70	✓
0967 28450	28,0 mm	450 mm	400 mm	1	111,13	✓
0967 30450	30,0 mm	450 mm	400 mm	1	140,71	✓



ACCESORIOS PARA MARTILLOS CON SISTEMA SDS PLUS / ACCESSOIRES SDS PLUS / ACCESSORIES FOR HAMMERS WITH SDS PLUS SYSTEM  
ACCESSORI PER MARTELLI SDS PLUS / ACESSÓRIOS PARA MARTELOS COM SISTEMA SDS PLUS

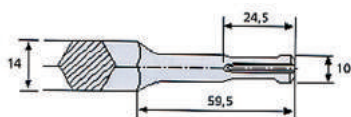

Cinzel / Plat / Chisel / Scalpello piatto / Cinzel

Ref	↔					
<b>0993 1001</b>	250 mm	14 mm	20 mm	1	<b>12,63</b>	✓

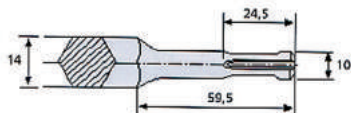

Puntero / Poincon / Pointer / Scalpello a punta / Punção

Ref	↔					
<b>0993 1002</b>	250 mm	14 mm	-	1	<b>12,50</b>	✓

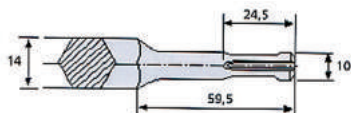

Rozador acanalador / Demi-rond  
Ribbed / Scanalatore Cinzel de canal

Ref	↔					
<b>0993 1003</b>	250 mm	14 mm	22 mm	1	<b>24,62</b>	✓

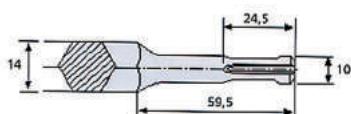

Cinzel ancho / Plat large / Wide chisel  
Scalpello spatola / Cinzel largo

Ref	↔					
<b>0993 1004</b>	250 mm	14 mm	40 mm	1	<b>21,23</b>	✓





BROCA OJIVAL PARA VIDRIO, CERÁMICA Y GRES / FORET OGIVAL POUR VERRE, CÉRAMIQUE ET GRÈS  
POINTED DRILLS FOR GLASS, CERAMICS AND EARTHENWARE / PUNTE TRAPANO OGIVALI PER VETRO, CERAMICA E GRES  
BROCA OGIVAL PARA VIDRO, CERÂMICA E GRÉS



Ref	Ø	↔	📦	📊	📄
0929 3003	3 mm	120 mm	1	5,63	✓
0929 3004	4 mm	120 mm	1	5,79	✓
0929 3005	5 mm	120 mm	1	6,37	✓
0929 3006	6 mm	120 mm	1	6,89	✓
0929 3007	7 mm	120 mm	1	8,20	✓
0929 3008	8 mm	120 mm	1	8,64	✓
0929 3009	9 mm	120 mm	1	11,67	✓
0929 3010	10 mm	120 mm	1	11,67	✓
0929 3012	12 mm	130 mm	1	17,62	✓

BROCAS PERCUTORAS SDS MAX PARA MUROS / FORETS SDS MAX - BETON / ROTARY HAMMER DRILL BIT WITH SDS MAX SHANK  
PUNTA SDS MAX DA MURO / BROCAS DE PERCUSSÃO SDS MAX PARA BETÃO

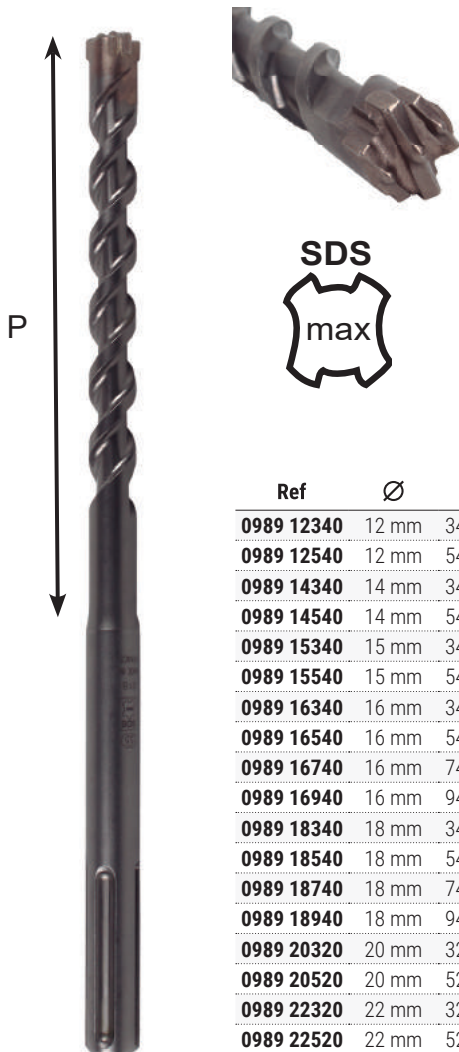

ES SDS MAX. Broca para martillo percutor con punta de 3 plaquetas de metal duro con 6 cortantes.  
FR SDS MAX. Foret pour perceur avec embout 3 plaques de métal dur.  
EN SDS MAX. Hammer drill with the point of 3 hard metal plates with 6 blades.  
IT SDS MAX. Punta per martello a percussione con 3 inserti di metallo duro, a 6 taglianti.  
PT SDS MAX. Broca para martelo de percussão com ponta de 3 placas de metal duro com 6 cortadores.

Ref	Ø	↔	P	📦	📊	📄	Ref	Ø	↔	P	📦	📊	📄
0989 12340	12 mm	340 mm	200 mm	1	61,16	✓	0989 22920	22 mm	920 mm	780 mm	1	144,00	✓
0989 12540	12 mm	540 mm	400 mm	1	71,01	✓	0989 24320	24 mm	320 mm	200 mm	1	88,54	✓
0989 14340	14 mm	340 mm	200 mm	1	73,35	✓	0989 24520	24 mm	520 mm	400 mm	1	118,49	✓
0989 14540	14 mm	540 mm	400 mm	1	84,05	✓	0989 25320	25 mm	320 mm	200 mm	1	91,53	✓
0989 15340	15 mm	340 mm	200 mm	1	81,92	✓	0989 25520	25 mm	520 mm	400 mm	1	112,91	✓
0989 15540	15 mm	540 mm	400 mm	1	85,13	✓	0989 25920	25 mm	920 mm	780 mm	1	164,46	✓
0989 16340	16 mm	340 mm	200 mm	1	81,93	✓	0989 26320	26 mm	320 mm	200 mm	1	97,52	✓
0989 16540	16 mm	540 mm	400 mm	1	89,61	✓	0989 26520	26 mm	520 mm	400 mm	1	120,63	✓
0989 16740	16 mm	740 mm	550 mm	1	114,56	✓	0989 28520	28 mm	520 mm	400 mm	1	120,63	✓
0989 16940	16 mm	940 mm	780 mm	1	130,11	✓	0989 28720	28 mm	720 mm	550 mm	1	168,10	✓
0989 18340	18 mm	340 mm	200 mm	1	84,25	✓	0989 28920	28 mm	920 mm	780 mm	1	219,81	✓
0989 18540	18 mm	540 mm	400 mm	1	91,94	✓	0989 30520	30 mm	520 mm	400 mm	1	134,30	✓
0989 18740	18 mm	740 mm	550 mm	1	115,49	✓	0989 32520	32 mm	520 mm	400 mm	1	144,59	✓
0989 18940	18 mm	940 mm	780 mm	1	131,54	✓	0989 32720	32 mm	720 mm	550 mm	1	172,89	✓
0989 20320	20 mm	320 mm	200 mm	1	84,25	✓	0989 32920	32 mm	920 mm	780 mm	1	219,30	✓
0989 20520	20 mm	520 mm	400 mm	1	96,89	✓	0989 35520	35 mm	520 mm	000 mm	1	163,39	✓
0989 22320	22 mm	320 mm	200 mm	1	86,60	✓	0989 35920	35 mm	920 mm	780 mm	1	281,46	✓
0989 22520	22 mm	520 mm	400 mm	1	101,16	✓	0989 38520	38 mm	520 mm	400 mm	1	212,20	✓
0989 22720	22 mm	720 mm	550 mm	1	133,80	✓	0989 40520	40 mm	520 mm	400 mm	1	275,45	✓



**ACCESORIOS PARA MARTILLOS CON SISTEMA SDS MAX / ACCESSOIRES SDS MAX / ACCESSORIES FOR HAMMERS WITH SDS MAX SYSTEM  
ACCESSORI PER MARTELLI SDS MAX / ACESSÓRIOS PARA MARTELOS COM SISTEMA SDS MAX**



Cinzel / Plat / Chisel / Scalpello piatto / Cinzel

Ref	↔					
<b>0993 0001</b>	280 mm	18 mm	24 mm	1	<b>16,60</b>	✓
<b>0993 0002</b>	400 mm	18 mm	24 mm	1	<b>16,17</b>	✓
<b>0993 0003</b>	600 mm	18 mm	24 mm	1	<b>19,97</b>	✓



Puntero / Poinçon / Pointer / Scalpello a punta / Punção

Ref	↔					
<b>0993 0004</b>	280 mm	18 mm	-	1	<b>16,19</b>	✓
<b>0993 0005</b>	400 mm	18 mm	-	1	<b>16,17</b>	✓
<b>0993 0006</b>	600 mm	18 mm	-	1	<b>22,49</b>	✓



Cinzel ancho / Plat large / Wide chisel  
Scalpello spatola / Cinzel largo

Ref	↔					
<b>0993 0007</b>	400 mm	18 mm	50 mm	1	<b>31,58</b>	✓



Cinzel pala / Pla extra large / Shovel chisel  
Scalpello largo / Cinzel pá

Ref	↔					
<b>0993 0008</b>	300 mm	18 mm	75 mm	1	<b>36,29</b>	✓



Rozador acanalador / Demi-rond / Ribbed  
Scanlatore / Cinzel de canal

Ref	↔					
<b>0993 0009</b>	300 mm	18 mm	22 mm	1	<b>36,93</b>	✓



BROCA ROTACIÓN PORCELÁNICO / FORET ROTATION PORCELAINE / DRILLS FOR PORCELAIN  
PUNTE TRAPANO PER PORCELLANA / BROCAS PARA PORCELANA



Ref	Ø	↔	📦	📊	📄
0929 0404	4 mm	120 mm	1	22,12	✓
0929 0405	5 mm	120 mm	1	23,41	✓
0929 0406	6 mm	150 mm	1	24,47	✓
0929 0407	7 mm	150 mm	1	28,01	✓
0929 0408	8 mm	150 mm	1	30,36	✓
0929 0410	10 mm	260 mm	1	36,80	✓

CORONAS DIAMANTADAS ESPECIAL PORCELANATO / COURONNES DIAMANTÉES SPÉCIAL PORCELAINE  
SPECIAL DIAMOND HOLLOW CORE FOR PORCELAIN / PUNTA SPECIALE DIAMANTATA PER PORCELLANA  
BROCAS DE DIAMANTE ESPECIAL PORCELANAS



ES Corona diamantada diseñada específicamente para grés y porcelánicos. La espiral inversa usa el giro de la broca para refrigerar la zona de corte durante el proceso. Esto crea un núcleo que guía la corona, la mantiene en la dirección deseada y no permite que patine.

FR Couronne diamantée conçue spécialement pour le grès et la porcelaine. La spirale inverse utilise la rotation du forêt pour refroidir la zone de coupe pendant le processus. Cela crée un noyau qui guide la couronne, la maintient dans la direction souhaitée et permet qu'elle ne patine pas.

EN Diamond hollow core specially designed for stoneware and porcelain. Cutting area is continuously refreshed thanks to the inverted spiral of the drill. This makes that the drill doesn't slide and is always on the right direction.

IT Punta diamantata progettata specificatamente per grés e porcellana. La spirale inversa permette un miglior raffreddamento della zona di taglio durante la perforazione. Questo mantiene la direzione desiderata non consentendone lo slittamento.

PT Concebida especificamente para grés e porcelanas. A espiral inversa utiliza a rotação da broca para arrefecer a zona do corte durante a perfuração. Isto cria um núcleo que guia a broca, a mantem na direção desejada e não permite que deslize.

Ref	Ø	↔	📦	📊	📄
0929 0500	5 mm	55 mm	1	19,70	✓
0929 0600	6 mm	55 mm	1	26,01	✓
0929 0700	7 mm	55 mm	1	29,84	✓
0929 0800	8 mm	55 mm	1	30,35	✓
0929 1000	10 mm	55 mm	1	30,99	✓
0929 1200	12 mm	55 mm	1	33,00	✓
0929 1500	15 mm	55 mm	1	35,76	✓
0929 2000	20 mm	55 mm	1	41,36	✓
0929 2500	25 mm	55 mm	1	50,06	✓



BROCAS PROFESIONALES PARA MADERA TRES PUNTAS / FORETS BOIS - TRIPLE POINTE PROFESSIONEL  
 PROFESSIONAL WOOD DRILL BITS WITH CENTER POINT / PUNTA PROFESSIONALE A 3 PUNTE PER LEGNO  
 BROCAS PROFISSIONAIS PARA MADEIRA TRÊS PONTAS



ES Broca en acero rápido rectificada con punta de centrado y labios de corte. Está formada por cabeza de tres puntas, que la hace más cómoda y duradera.  
 FR Foret en acier rapide rectifié embout de centrage et bec de coupe. Il est formé d'une tête de 3 embouts, pour plus de commodité et de durée.  
 EN Professional wood drill bit with center-point and cutting lips. It is formed by a three-point head, that makes it long-lasting and comfortable.  
 IT Punta in acciaio rapido rettificata con punta di centraggio. E' realizzata con una testa a tre punte per una maggiore comodità e durata.  
 PT Broca em aço rápida retificada com ponta de centrar e bordos de corte. É formada por cabeça de 3 pontas o que a faz mais cómoda e duradoura.

Ref	Ø	P			
0979 0360	3 mm	60 mm	1	1,12	✓
0979 0470	4 mm	70 mm	1	1,20	✓
0979 0585	5 mm	85 mm	1	1,42	✓
0979 0690	6 mm	90 mm	1	1,76	✓
0979 07105	7 mm	105 mm	1	2,02	✓
0979 08110	8 mm	110 mm	1	2,27	✓
0979 09115	9 mm	115 mm	1	3,00	✓
0979 10120	10 mm	120 mm	1	3,48	✓
0979 11130	11 mm	130 mm	1	3,99	✓
0979 12140	12 mm	140 mm	1	4,63	✓
0979 13150	13 mm	150 mm	1	4,84	✓
0979 14150	14 mm	150 mm	1	7,37	✓
0979 16160	16 mm	160 mm	1	10,41	✓
0979 18180	18 mm	180 mm	1	17,60	✓
0979 20200	20 mm	200 mm	1	22,54	✓



**Bricofan**

Ref	Ø				
6220 0300	3 mm	1 blister x 1 ud	1	1,39	✓
6220 0400	4 mm	1 blister x 1 ud	1	1,43	✓
6220 0500	5 mm	1 blister x 1 ud	1	1,51	✓
6220 0600	6 mm	1 blister x 1 ud	1	1,84	✓
6220 0700	7 mm	1 blister x 1 ud	1	2,05	✓
6220 0800	8 mm	1 blister x 1 ud	1	2,34	✓
6220 0900	9 mm	1 blister x 1 ud	1	3,05	✓
6220 1000	10 mm	1 blister x 1 ud	1	3,57	✓
6220 1100	11 mm	1 blister x 1 ud	1	4,07	✓
6220 1200	12 mm	1 blister x 1 ud	1	4,69	✓
6220 1300	13 mm	1 blister x 1 ud	1	4,90	✓

JUEGOS DE BROCAS PROFESIONALES PARA MADERA / JEU DE FORETS POUR LE BOIS / WOOD TWIST DRILL SETS  
 SET DI PUNTE PROFESSIONALI DA LEGNO / JOGOS DE BROCAS PROFISSIONAIS PARA MADEIRA



Ref				
0979 0001	4, 5, 6, 8, 10 mm	5 pcs	1	13,14
0979 0002	3, 4, 5, 6, 7, 8, 9, 10 mm	8 pcs	1	21,37

**BROCA PARA MADERA MANGO HEX. 1/4" / FORET POUR BOIS MANCHE HEX. 1/4" / WOOD DRILL BIT WITH 1/4" HEXAGONAL HANDLE  
PUNTA PER LEGNO, MANICO ESAGONALE 1/4" / BROCA PARA MADEIRA, HASTE HEX. 1/4"**

ES Broca de tres puntas para madera, con mango hexagonal de 1/4". Fabricada en cromo vanadio. Aplicaciones: Maderas, maderas blandas y aglomerados.  
FR Forêt de trois pointes pour bois avec manche hexagonal de 1/4". Fabriqué en chrome vanadium. Applications: Bois, Bois fin et agglomérés.  
EN Wood drill bit with three-points head and with a 1/4" hexagonal handle. Chrome vanadium. Application: Wood, softwood and chipboards.  
IT Punta per legno con manico esagonale da 1/4". Fabricata in cromo vanadio. Applicazioni: Legno, legno dolce o truciolo.  
PT Broca de três pontas para madeira, com haste hexagonal de 1/4". Fabricada em cromo vanádio. Aplicação: madeiras, madeiras leves e aglomerados.

Ref	Ø			
0979 5002	2 mm	1	0,99	✓
0979 5003	3 mm	1	0,84	✓
0979 5004	4 mm	1	0,92	✓
0979 5005	5 mm	1	1,17	✓
0979 5006	6 mm	1	1,24	✓
0979 5007	7 mm	1	1,43	✓
0979 5008	8 mm	1	1,65	✓
0979 5009	9 mm	1	1,73	✓
0979 5010	10 mm	1	1,99	✓
0979 5011	11 mm	1	2,19	✓
0979 5012	12 mm	1	2,40	✓

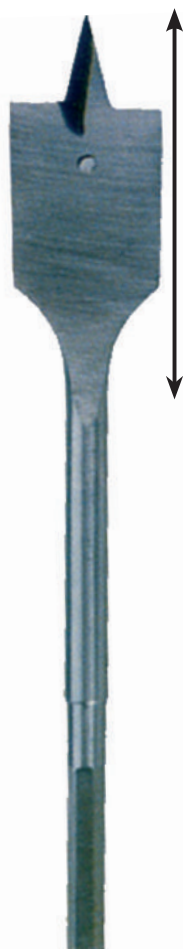
**BROCAS DE PALA PARA MADERA / FORET PLAT POUR BOIS / WOOD FLAT DRILL BITS / PUNTE LEGNO PIATTE / BROCA CHATA PARA MADEIRA**

ES Broca profesional para madera tipo pala. Broca plana de acero cromo vanadio con punta centradora y 2 puntas a los lados.  
FR Forets bois - professionnel. Foret plat en acier chromé vanadium avec embout central et deux embouts côtes.  
EN Professional wood drill bits with center point. Flat chrome vanadium steel drill, with centering point and two side points.  
IT Punta piatta professionale, per legno. Punta in acciaio al cromo vanadio, con punta di centraggio e 2 punte ai lati.  
PT Broca profissional para madeira tipo pá. Broca chata de aço cromo vanádio com ponta de centrar e 2 pontas aos lados.

Ref	Ø	P			
0992 0006	6 mm	156 mm	1	1,30	✓
0992 0008	8 mm	156 mm	1	1,50	✓
0992 0010	10 mm	156 mm	1	1,60	✓
0992 0012	12 mm	156 mm	1	1,67	✓
0992 0014	14 mm	156 mm	1	1,78	✓
0992 0015	15 mm	156 mm	1	2,07	✓
0992 0016	16 mm	156 mm	1	2,07	✓
0992 0018	18 mm	156 mm	1	2,21	✓
0992 0019	19 mm	156 mm	1	2,36	✓
0992 0020	20 mm	156 mm	1	2,36	✓
0992 0022	22 mm	156 mm	1	2,91	✓
0992 0024	24 mm	156 mm	1	3,18	✓
0992 0025	25 mm	156 mm	1	3,32	✓
0992 0026	26 mm	172 mm	1	3,60	✓
0992 0028	28 mm	172 mm	1	3,85	✓
0992 0030	30 mm	172 mm	1	4,14	✓
0992 0032	32 mm	172 mm	1	4,35	✓
0992 0033	33 mm	172 mm	1	4,57	✓
0992 0034	34 mm	172 mm	1	5,06	✓
0992 0035	35 mm	172 mm	1	5,24	✓
0992 0036	36 mm	172 mm	1	5,45	✓
0992 0038	38 mm	172 mm	1	5,65	✓
0992 0040	40 mm	172 mm	1	5,94	✓





**BROCAS ESCALONADAS HSS / FORETS FRAISEURS / HSS COUNTERSINK DRILLS / PUNTA SVASATRICE / ESCAREADORES HSS**



Ref	Ø	↔	📦	📦
<b>0990 2012</b>	4-12x1 mm	69 mm	1	<b>40,57</b>
<b>0990 2412</b>	4-12x2 mm	69 mm	1	<b>38,82</b>
<b>0990 2020</b>	4-20x2 mm	75 mm	1	<b>52,40</b>
<b>0990 2030</b>	6-30x2 mm	95 mm	1	<b>108,34</b>
<b>0990 2120</b>	12-20x1 mm	75 mm	1	<b>71,59</b>
<b>0990 2230</b>	20-3x1 mm	93 mm	1	<b>99,65</b>
<b>0990 2440</b>	30-40x1 mm	93 mm	1	<b>180,45</b>
<b>0990 2050</b>	40-50x1 mm	97 mm	1	<b>255,40</b>
<b>0990 2060</b>	50-60x1 mm	97 mm	1	<b>401,47</b>

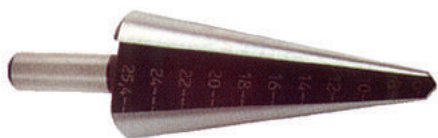

Ref	Ø	↔	📦	📦
<b>0990 0014</b>	3 - 14 mm	62 mm	1	<b>18,98</b>
<b>0990 0020</b>	6 - 20 mm	70 mm	1	<b>26,47</b>
<b>0990 0030</b>	16 - 30 mm	78 mm	1	<b>53,90</b>
<b>0990 0040</b>	26 - 40 mm	86 mm	1	<b>114,09</b>
<b>0990 0050</b>	36 - 50 mm	90 mm	1	<b>175,73</b>
<b>0990 0060</b>	46 - 60 mm	94 mm	1	<b>341,21</b>
<b>0990 0630</b>	6 - 30 mm	106 mm	1	<b>66,23</b>
<b>0990 0022</b>	6 - 22,5 mm	80 mm	1	<b>50,64</b>
<b>0990 0025</b>	6 - 25,4 mm	84 mm	1	<b>53,39</b>

**BROCAS ESCALONADAS DE TITANIO / FORETS FRAISEURS / TITANIUM COUNTERSINK DRILLS / PUNTA SVASATRICE / ESCAREADOR TITÂNIO**



Ref	Ø	↔	📦	📦
<b>0990 3012</b>	4-12x1 mm	69 mm	1	<b>90,14</b>
<b>0990 3412</b>	4-12x2 mm	69 mm	1	<b>88,25</b>
<b>0990 3020</b>	4-20x2 mm	75 mm	1	<b>114,51</b>
<b>0990 3030</b>	6-30x2 mm	95 mm	1	<b>164,46</b>
<b>0990 3120</b>	12-20x1 mm	75 mm	1	<b>103,50</b>
<b>0990 3230</b>	20-30x1 mm	93 mm	1	<b>154,14</b>
<b>0990 3040</b>	30-40x1 mm	93 mm	1	<b>293,14</b>



Ref	Ø	↔	📦	📦
<b>0990 1010</b>	3 - 14 mm	62 mm	1	<b>56,26</b>
<b>0990 1020</b>	6 - 20 mm	70 mm	1	<b>61,82</b>
<b>0990 1030</b>	16 - 30 mm	78 mm	1	<b>99,35</b>
<b>0990 1040</b>	26 - 40 mm	86 mm	1	<b>175,95</b>
<b>0990 1050</b>	36 - 50 mm	90 mm	1	<b>250,67</b>
<b>0990 1060</b>	46 - 60 mm	94 mm	1	<b>423,50</b>
<b>0990 1630</b>	6 - 30 mm	106 mm	1	<b>113,53</b>

**AVELLANADORES CÓNICOS C-AGUJERO / CONIQUE À TROU COUNTERBORES / COUNTERSINK DRILL WITH C-HOLE  
SVASATRICE CONICA / ESCAREADOR CÔNICO C-COM FURO**



Ref	Ø	↔	📦	📦
<b>0991 1005</b>	2 - 5 mm	45 mm	1	<b>15,47</b>
<b>0991 1010</b>	5 - 10 mm	48 mm	1	<b>19,32</b>
<b>0991 1015</b>	10 - 15 mm	65 mm	1	<b>34,62</b>
<b>0991 1020</b>	15 - 20 mm	85 mm	1	<b>61,82</b>
<b>0991 1025</b>	20 - 25 mm	95 mm	1	<b>104,35</b>
<b>0991 1030</b>	25 - 30 mm	100 mm	1	<b>160,27</b>



AVELLANADORES CÓNICOS 90° / CONIQUE 90° / 90° CONE COUNTERSINK DRILL / SVASATRICE CONICA 90° / ESCAREADORES CÔNICOS 90°



Ref	Ø	↔		
0991 0043	4,30 mm	40 mm	1	14,52
0991 0050	5,00 mm	40 mm	1	14,52
0991 0053	5,30 mm	40 mm	1	15,97
0991 0058	5,80 mm	45 mm	1	11,06
0991 0060	6,00 mm	45 mm	1	10,49
0991 0063	6,30 mm	45 mm	1	10,33
0991 0070	7,00 mm	50 mm	1	14,54
0991 0073	7,30 mm	50 mm	1	14,54
0991 0080	8,00 mm	50 mm	1	14,54
0991 0083	8,30 mm	50 mm	1	14,31
0991 0091	9,40 mm	50 mm	1	16,97
0991 0100	10,00 mm	50 mm	1	16,97
10991 0104	10,40 mm	50 mm	1	16,63
0991 0115	11,50 mm	56 mm	1	17,01
0991 0124	12,40 mm	56 mm	1	16,70
0991 0134	13,40 mm	56 mm	1	18,42
0991 0150	15,00 mm	60 mm	1	23,40
0991 0165	16,50 mm	60 mm	1	23,28
0991 0190	19,00 mm	63 mm	1	34,40
0991 0205	20,50 mm	63 mm	1	34,64
0991 0230	23,00 mm	67 mm	1	42,33
0991 0250	25,00 mm	67 mm	1	42,68
0991 0260	26,00 mm	67 mm	1	50,25
0991 0280	28,00 mm	71 mm	1	61,82
0991 0300	30,00 mm	71 mm	1	65,68
0991 0310	31,00 mm	71 mm	1	68,42
0991 0400	40,00 mm	80 mm	1	98,06

ACCESORIOS TALADRO / ACCESSOIRES FORETS / DRILLS ACCESSORIES  
ACCESSORI PER PUNTE / ACESSÓRIOS BROCAS

PORTABROCAS CIERRE CON LLAVE (1,5 - 13 mm) / SUPPORT FORET FERMETURE AVEC CLÉ (1,5 - 13 mm) / DRILL HOLDER WITH LOCK (1,5 - 13 mm)  
MANDRINO A CREM. CON LEVA (1,5 - 13 mm) / PORTABROCAS FECHO COM CHAVE (1,5 - 13 mm)

1,5 - 13 mm



Ref	↔			
0994 0089	115 mm	½"x20H UNF	1	26,75

PORTABROCAS CIERRE CON LLAVE (1 - 10 mm) / SUPPORT FORET FERMETURE AVEC CLÉ (1 - 10 mm) / DRILL HOLDER WITH LOCK (1 - 10 mm)  
MANDRINO A CREM. CON LEVA (1 - 10 mm) / PORTABROCAS FECHO COM CHAVE (1 - 10 mm)

1 - 10 mm



Ref	↔			
0994 0088	115 mm	½"x20H UNF	1	23,95



ACCESORIOS TALADROS VARIOS / ACCESSOIRES FORETS EMBOUT CÔNE MORSE / DIFFERENT SHANK TWIST DRILLS ACCESSORIES  
ACCESSORI PER PUNTE A GAMBO CONICO / VÁRIOS ACESSÓRIOS BROCAS

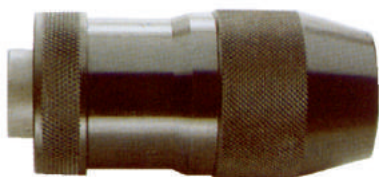

ES Portabrocas automático para uso industrial taladros fijos y portátiles.  
FR Porte foret automatique pour usage industriel perceuse fixe et portable.  
EN Automatic drill holder for industrial use fixed and portable drills.  
IT Mandrino automatico per uso industriale, trapani fissi e portatili.  
PT Suporte automático de broca para uso industrial, brocas fixas e portáteis.

Ref	∅				
<b>0994 0085</b>	1,5 -13 mm	-	1/2"x20h	1	<b>67,37</b>
<b>0994 0086</b>	3 - 16 mm	B-16	-	1	<b>88,99</b>
<b>0994 0087</b>	3 - 16 mm	B-18	-	1	<b>88,99</b>



ES Cierre de seguridad.  
FR Dispositif de fermeture de sécurité.  
EN Safety lock.  
IT Chiusura di sicurezza.  
PT Fecho de segurança.

Ref	∅			
<b>0994 0081</b>	1 - 10 mm	3/8"x24H UNF	1	<b>66,15</b>
<b>0994 0082</b>	2 - 13 mm	1/2"x20H UNF	1	<b>71,60</b>



ES Adaptador rosca portabrocas (3/8" - 1/2").  
FR Adaptateur filete support foret (3/8" - 1/2").  
EN Adaptor for drill holders (3/8" - 1/2").  
IT Adattatore filettato per mandrino (3/8" - 1/2").  
PT Adaptador rosca portabrocas (3/8" - 1/2").

Ref					
<b>0994 0072</b>	80 mm	3/8" x24h - 1/2" x20h	1	<b>4,80</b>	✓



ES Adaptador taladro normal a SDS+.  
FR Adaptateur perceuse normale a SDS+.  
EN SDS+ common drill adapter.  
IT Adattatore da trapani normali a SDS+.  
PT Adaptador broca normal a SDS+.

Ref			
<b>0994 0071</b>	59 mm	1	<b>77,67</b>



ES Adaptador para martillos SDS+ a portabrocas normal.  
FR Adaptateur pour marteaux perceuse normale.  
EN SDS+ chuck spare key with manual closing.  
IT Adattatore da martelli SDS+ a trapani normali.  
PT Adaptador para martelos SDS+ com fecho manual.

Ref				
<b>0994 0070</b>	63 mm	1/2"x20H UNF	1	<b>27,61</b>



ACCESORIOS TALADROS VARIOS / ACCESSOIRES FORETS EMBOUT CÔNE MORSE / DIFFERENT SHANK TWIST DRILLS ACCESSORIES  
ACCESSORI PER PUNTE A GAMBO CONICO / VÁRIOS ACESSÓRIOS BROCAS

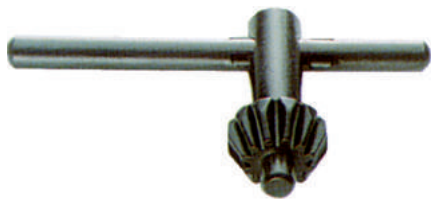

- ES Llave de recambio para mandril con cierre manual.
- FR Cle de rechange pour mandrin avec fermeture manuelle.
- EN Nipple wrench with manual lock.
- IT Chiave di ricambio per mandrino a chiusura manuale.
- PT Chave de reposição para mandril com fechamento manual.

Ref			
<b>0994 0065</b>	STANDARD	1	<b>4,24</b>



- ES Cuña expulsora conos morse DIN 317.
- FR Ejecteurs DIN 317.
- EN Drill drifts DIN 317.
- IT Cuneo di estrazione DIN 317.
- PT Cunha para brocas cone morse DIN 317.

Ref	Ø		
<b>0994 0060</b>	1 - 2 mm	1	<b>11,93</b>
<b>0994 0061</b>	2 - 3 mm	1	<b>14,13</b>
<b>0994 0062</b>	3 - 4 mm	1	<b>18,67</b>
<b>0994 0063</b>	4 - 5 mm	1	<b>25,35</b>
<b>0994 0064</b>	5 - 6 mm	1	<b>44,00</b>

ACCESORIOS BROCAS MANGO CÓNICO "CONO MORSE" / ACCESSOIRES FORETS EMBOUT CÔNE MORSE  
MORSE TAPER SHANK TWIST DRILLS ACCESSORIES / ACCESSORI PER PUNTE A GAMBO CONICO  
ACESSÓRIOS BROCAS HASTE CÔNICA "CONE MORSE"



Espiga de sujeción / Queues a tenon / Spike cone morse tapers / Gambo di supporto / Espiga cone morse

Ref						Ref					
<b>0994 0010</b>	99 mm	1	B-16	1	<b>9,17</b>	<b>0994 0015</b>	140 mm	3	B-18	1	<b>13,62</b>
<b>0994 0011</b>	107 mm	1	B-18	1	<b>9,17</b>	<b>0994 0016</b>	156 mm	4	B-16	1	<b>19,43</b>
<b>0994 0012</b>	112 mm	2	B-16	1	<b>11,12</b>	<b>0994 0017</b>	165 mm	4	B-18	1	<b>20,96</b>
<b>0994 0013</b>	119 mm	2	B-18	1	<b>11,12</b>	<b>0994 0018</b>	221 mm	5	B-16	1	<b>82,72</b>
<b>0994 0014</b>	134 mm	3	B-16	1	<b>13,62</b>	<b>0994 0019</b>	221 mm	5	B-18	1	<b>88,36</b>



Cono de reducción / Douilles de reduction / Reducing sleeves / Cono di riduzione / Cone de redução

Ref						Ref					
<b>0994 0025</b>	92 mm	2	1	1	<b>22,39</b>	<b>0994 0032</b>	156 mm	5	2	1	<b>62,50</b>
<b>0994 0026</b>	99 mm	3	1	1	<b>27,61</b>	<b>0994 0033</b>	156 mm	5	3	1	<b>60,74</b>
<b>0994 0027</b>	112 mm	3	2	1	<b>27,61</b>	<b>0994 0034</b>	171 mm	5	4	1	<b>70,89</b>
<b>0994 0028</b>	124 mm	4	1	1	<b>38,66</b>	<b>0994 0035</b>	230 mm	6	3	1	<b>121,42</b>
<b>0994 0029</b>	124 mm	4	2	1	<b>36,31</b>	<b>0994 0036</b>	230 mm	6	4	1	<b>133,87</b>
<b>0994 0030</b>	140 mm	4	3	1	<b>36,31</b>	<b>0994 0037</b>	230 mm	6	5	1	<b>140,53</b>
<b>0994 0031</b>	180 mm	5	1	1	<b>65,97</b>						



Alargador para conos morse / Adapteur / Extension sockets / Adattatori / Extensor para conos morse

Ref						Ref					
<b>0994 0040</b>	145 mm	1	1	1	<b>28,20</b>	<b>0994 0050</b>	215 mm	4	2	1	<b>59,72</b>
<b>0994 0041</b>	160 mm	1	2	1	<b>44,95</b>	<b>0994 0051</b>	240 mm	4	3	1	<b>60,69</b>
<b>0994 0042</b>	160 mm	2	1	1	<b>28,20</b>	<b>0994 0052</b>	265 mm	4	4	1	<b>105,10</b>
<b>0994 0043</b>	175 mm	2	2	1	<b>41,00</b>	<b>0994 0053</b>	300 mm	4	5	1	<b>168,04</b>
<b>0994 0044</b>	196 mm	2	3	1	<b>59,36</b>	<b>0994 0054</b>	232 mm	5	1	1	<b>115,78</b>
<b>0994 0045</b>	175 mm	3	1	1	<b>41,00</b>	<b>0994 0055</b>	247 mm	5	2	1	<b>109,53</b>
<b>0994 0046</b>	194 mm	3	2	1	<b>45,20</b>	<b>0994 0056</b>	268 mm	5	3	1	<b>115,65</b>
<b>0994 0047</b>	215 mm	3	3	1	<b>63,89</b>	<b>0994 0057</b>	300 mm	5	4	1	<b>130,74</b>
<b>0994 0048</b>	240 mm	3	4	1	<b>100,11</b>	<b>0994 0058</b>	335 mm	5	5	1	<b>216,31</b>
<b>0994 0049</b>	200 mm	4	1	1	<b>61,11</b>						



AFILADOR BROCAS ELÉCTRICO (3A 13 MM) / AIGUISEUR FORET ÉLECTRIQUE (3A 13 MM) / ELECTRIC DRILL BIT SHARPENER (3A 13 MM)  
 AFFILAPUNTE ELETTRICO (3A 13 MM) / AFIADOR BROCAS ELÉTRICO (3A 13 MM)



ES Incluye.  
 FR Inclut.  
 EN Contains.  
 IT Contiene.  
 PT Inclui.



Ref		
0994 4075	1	175,60

MANDRIL PORTABROCA AFILADOR BROCAS / MANDRIN PORTE FORETS AIGUISEUR FORETS / DRILL CHUCK BIT SHARPENER  
 MANDRINO PER AFFILAPUNTE / MANDRIL PORTA BROCA AFIADOR BROCAS



Ref		
0994 4076	1	32,95

MUELA AFILADOR PORTABROCAS / MEULE AIGUISEUSE PORTE-MÈCHE / GRINDING WHEEL FOR DRILL BIT SHARPENER  
 MOLA PER AFFILAPUNTE / MOLA AFIADRO PORTA BROCAS



Ref		
0994 4077	1	34,93





MACHOS MANUALES / TARAUDS A MAIN / HAND TAPS / MASCHI MANUALI / MACHOS MANUAIS



PASOS / PAS / THREADS / PASSI / ROSCA

MÉTRICO - WITHWORTH - GAS - BSF - BSP - UNC - UNF, SAE - BSPT - UNEF - BA Y PG - NPT

\* Posibilidad de consultar cualquier paso de rosca.

\* Possibilité de consulter tous les pas de vis.

\* Other threads available, please contact us.

\* Verificare disponibilità passi filettatura.

\* Consultar qualquer rosca ou medida.

**MÉTRICO**

Ref	MxP	↓	☒	☒
0995 0305	M3 x 0,50 mm	3	1	18,77
0995 0407	M4 x 0,70 mm	3	1	18,44
0995 0508	M5 x 0,80 mm	3	1	18,18
0995 0610	M6 x 1,00 mm	3	1	19,28
0995 0710	M7 x 1,00 mm	3	1	24,17
0995 0775	M7 X 0,75 mm	2	1	28,93
0995 0810	M8 x 1,00 mm	2	1	20,01
0995 0812	M8 x 1,25 mm	3	1	21,08
0995 0912	M9 x 1,25 mm	3	1	37,36
0995 1010	M10 x 1,00 mm	2	1	21,72
0995 1012	M10 x 1,25 mm	2	1	22,11
0995 1015	M10 x 1,50 mm	3	1	26,61
0995 1115	M11 X 1,50 mm	3	1	55,31
0995 1210	M12 X 1,00 mm	2	1	37,91
0995 1212	M12 x 1,25 mm	2	1	38,09
0995 1215	M12 x 1,50 mm	2	1	32,39
0995 1217	M12 x 1,75 mm	3	1	37,11
0995 1412	M14 X1,25 mm	2	1	46,53
0995 1415	M14 x 1,50 mm	2	1	36,14
0995 1420	M14 x 2,00 mm	3	1	45,50
0995 1515	M15 X1,50 mm	2	1	93,98
0995 1610	M16 x 1,00 mm	2	1	85,21
0995 1615	M16 x 1,50 mm	2	1	45,07
0995 1620	M16 x 2,00 mm	3	1	64,04
0995 1810	M18 X1,00 mm	2	1	99,10
0995 1815	M18 x 1,50 mm	2	1	59,76
0995 1820	M18 x 2,00 mm	2	1	104,06
0995 1825	M18 x 2,50 mm	3	1	87,16
0995 2010	M20 X1,00 mm	2	1	133,44
0995 2015	M20 x 1,50 mm	2	1	76,07
0995 2020	M20 x 2,00 mm	2	1	107,85
0995 2025	M20 x 2,50 mm	3	1	96,23
0995 2210	M22 x 1,00 mm	2	1	140,68
0995 2215	M22 x 1,50 mm	2	1	85,56
0995 2225	M22 x 2,50 mm	3	1	146,49
0995 2415	M24 x 1,50 mm	2	1	104,10
0995 2420	M24 x 2,00 mm	2	1	171,85
0995 2430	M24 x 3,00 mm	3	1	172,00
0995 2730	M27 x 3,00 mm	3	1	229,31
0995 3035	M30 x 3,50 mm	3	1	291,15
0995 3335	M33 x 3,50 mm	3	1	364,26
0995 3640	M36 x 4,00 mm	3	1	475,70
0995 3940	M39 x 4,00 mm	3	1	521,23
0995 4245	M42 x 4,50 mm	3	1	653,09
0995 4545	M45 x 4,50 mm	3	1	757,53
0995 4850	M48 x 5,00 mm	3	1	909,82
0995 5250	M52 x 5,00 mm	3	1	1170,40

**WHITWORTH**

Ref	MxP	↓	☒	☒
0995 0180W	W 1/8-40h	3	1	22,19
0995 0532W	W 5/32-32h	3	1	22,41
0995 0316W	W 3/16-24h	3	1	22,19
0995 0140W	W 1/4-20h	3	1	24,98
0995 0516W	W 5/16-18h	3	1	30,51
0995 0380W	W 3/8-16h	3	1	33,55
0995 0716W	W 7/16-14h	3	1	44,60
0995 0120UNC	W UNC1/2-13h	3	1	75,18
0995 0120W	W 1/2-12h	3	1	48,29
0995 0916W	W 9/16" 12h	3	1	73,95
0995 0580W	W 5/8-11h	3	1	80,96
0995 0340W	W 3/4-10h	3	1	114,19
0995 0708W	W 7/8- 9h	3	1	143,52
0995 0001W	W 1"-8h	3	1	203,64

**PASO GAS "BSPT"**

Ref	MxP	↓	☒	☒
0995 1180G	G 1/8-28h	2	1	28,11
0995 1140G	G 1/4-19h	2	1	39,59
0995 1380G	G 3/8-19h	2	1	49,83
0995 1120G	G 1/2-14h	2	1	69,71
0995 1340G	G 3/4-14h	2	1	108,50
0995 0708G	G 7/8-14h	2	1	157,21
0995 1100G	G 1"-11h	2	1	173,29

**PASO SAE**

Ref	MxP	↓	☒	☒
0995 0140S	SAE 1/4-28h	2	1	22,70
0995 0380S	SAE 3/8-24h	2	1	33,77
0995 0516S	SAE 5/16-24h	2	1	27,41
0995 0716S	SAE 7/16-20h	2	1	43,46
0995 1120S	SAE 1/2-20h	2	1	45,86
0995 0580S	SAE 5/8-18h	2	1	74,26
0995 0916S	SAE 9/16-18h	2	1	51,98
0995 0340S	SAE 3/4-16h	2	1	99,74
0995 0708S	SAE 7/8-14h	2	1	130,87
0995 0001S	SAE 1"-12h	2	1	173,50



TERRAJAS DE ROSCAR / FILIERES / SPLIT DIES / FILIERE / CANÇONETE DE ROSCAR



PASOS / PAS / THREADS / PASSI / ROSCA

MÉTRICO - WITHWORTH - GAS - BSF - BSP - UNC - UNF, SAE - BSPT - UNEF - BA Y PG - NPT

\* Consultar cualquier paso o medida.

\* Consulter tout les pas de vis ou les mesures.

\* Other threads or measurements available, please contact us.

\* Verificare disponibilità passi e misure.

\* Consultar qualquer rosca ou medida.

**MÉTRICO**

Ref	Ø	P		
0996 0305	20 mm	M3 x 0,50	1	23,86
0996 0407	20 mm	M4 x 0,70	1	23,86
0996 0508	20 mm	M5 x 0,80	1	23,86
0996 0610	20 mm	M6 x 1,00	1	23,86
0996 0710	25 mm	M7 x 1,00	1	26,01
0996 0810	25 mm	M8 x 1,00	1	30,79
0996 0812	25 mm	M8 x 1,25	1	24,91
0996 0912	25 mm	M9 x 1,25	1	36,69
0996 1010	30 mm	M10 x 1,00	1	32,66
0996 1012	30 mm	M10 x 1,25	1	40,91
0996 1015	30 mm	M10 x 1,50	1	35,57
0996 1210	38 mm	M12 x 1,00	1	44,82
0996 1212	38 mm	M12 x 1,25	1	55,45
0996 1215	38 mm	M12 x 1,50	1	42,60
0996 1217	38 mm	M12 x 1,75	1	39,10
0996 1412	38 mm	M14 x 1,25	1	54,40
0996 1415	38 mm	M14 x 1,50	1	41,86
0996 1420	38 mm	M14 x 2,00	1	39,10
0996 1615	45 mm	M16 x 1,50	1	49,59
0996 1620	45 mm	M16 x 2,00	1	54,41
0996 1815	45 mm	M18 x 1,50	1	61,18
0996 1820	45 mm	M18 x 2,00	1	64,99
0996 1825	45 mm	M18 x 2,50	1	57,02
0996 2010	45 mm	M20 x 1,00	1	68,47
0996 2015	45 mm	M20 x 1,50	1	73,41
0996 2020	45 mm	M20 x 2,00	1	77,01
0996 2025	45 mm	M20 x 2,50	1	61,08
0996 2215	55 mm	M22 x 1,50	1	81,45
0996 2225	55 mm	M22 x 2,50	1	81,45
0996 2415	55 mm	M24 x 1,50	1	81,45
0996 2420	55 mm	M24 x 2,00	1	88,48
0996 2430	55 mm	M24 x 3,00	1	88,48
0996 2730	65 mm	M27 x 3,00	1	123,50
0996 3015	65 mm	M30 x 1,50	1	142,28
0996 3035	65 mm	M30 x 3,50	1	123,50
0996 3335	65 mm	M33 x 3,50	1	123,50
0996 3640	65 mm	M36 x 4,00	1	132,09
0996 3940	75 mm	M39 x 4,00	1	198,29
0996 4245	75 mm	M42 x 4,50	1	198,29
0996 4545	90 mm	M45 x 4,50	1	303,30
0996 4850	90 mm	M48 x 5,00	1	303,30
0996 5250	90 mm	M52 x 5,00	1	303,30

**WHITWORTH**

Ref	Ø	P		
0996 0180W	20 mm	W 1/8-40h	1	26,42
0996 0532W	20 mm	W 5/32-32h	1	28,87
0996 0316W	20 mm	W 3/16-24h	1	26,42
0996 0140W	20 mm	W 1/4-20h	1	26,42
0996 0516W	25 mm	W 5/16-18h	1	26,87
0996 0380W	30 mm	W 3/8-16h	1	44,87
0996 0716W	30 mm	W 7/16-14h	1	40,38
0996 0120W	38 mm	W 1/2-12h	1	38,90
0996 0120UNC	38 mm	W UNC1/2-13h	1	52,07
0996 0508W	38 mm	W 5/8"-11h	1	69,69
0996 0340W	45 mm	W 3/4-10h	1	64,47
0996 0708W	55 mm	W 7/8"-9h	1	91,19
0996 0100W	55 mm	W 1"-8h	1	91,19

**PASO GAS "BSPT"**

Ref	Ø	P		
0996 1180G	30 mm	G 1/8-28h	1	42,86
0996 1140G	38 mm	G 1/4-19h	1	42,86
0996 1380G	45 mm	G 3/8-19h	1	55,44
0996 1120G	45 mm	G 1/2-14h	1	55,44
0996 1340G	55 mm	G 3/4-14h	1	114,89
0996 1100G	65 mm	G 1"-11h	1	139,86

**PASO SAE**

Ref	Ø	P		
0996 0316S	20 mm	SAE 3/16-32h	1	38,56
0996 0140S	20 mm	SAE 1/4-28h	1	32,70
0996 0516S	25 mm	SAE 5/16-24h	1	32,08
0996 0380S	30 mm	SAE 3/8-24h	1	50,24
0996 0716S	38 mm	SAE 7/16-20h	1	51,46
0996 0120S	38 mm	SAE 1/2"-20h	1	48,62
0996 0508S	45 mm	SAE 5/8"-18h	1	73,82
0996 0340S	45 mm	SAE 3/4-16h	1	64,47
0996 0708S	55 mm	SAE 7/8"-14h	1	99,15
0996 0100S	55 mm	SAE 1"-12h	1	99,15



MACHOS DE ROSCAR A MÁQUINA / TARAUDS MACHINE / MACHINE TAPS  
MASCHI DA MACCHINA UTENSILE / MACHOS DE ENROSCAR PARA MÁQUINA



**HSS E-DIN 371 FORM B**

Ref	↔	P	MxP	📦	📊
0963 0350	56 mm	11 mm	M3 x 0,50 mm	1	15,27
0963 0470	63 mm	13 mm	M4 x 0,70 mm	1	12,20
0963 0580	70 mm	16 mm	M5 x 0,80 mm	1	12,20
0963 0610	80 mm	19 mm	M6 x 1,00 mm	1	13,31
0963 0812	90 mm	22 mm	M8 x 1,25 mm	1	14,96
0963 0912	90 mm	22 mm	M9 x 1,25 mm	1	26,54
0963 1010	90 mm	18 mm	M10 x 1,00 mm	1	26,26
0963 1012	100 mm	20 mm	M10 x 1,25 mm	1	31,36
0963 1015	100 mm	24 mm	M10 x 1,50 mm	1	18,43

ES Para agujeros pasantes 400-800 N/mm.  
FR Pour trous pasants 400-800 N/mm.  
EN Holes assistants 400-800 N/mm.  
IT Per fori passanti 400-800 N/mm.  
PT Para furos de passo 400-800 N/mm.



**HSS E-DIN 376/374 FORM B**

Ref	↔	P	MxP	📦	📊
0963 1212	100 mm	22 mm	M12 x 1,25 mm	1	36,11
0963 1215	100 mm	22 mm	M12 x 1,50 mm	1	32,23
0963 1217	110 mm	29 mm	M12 x 1,75 mm	1	23,56
0963 1317	110 mm	27 mm	M13 x 1,75 mm	1	63,30
0963 1420	110 mm	30 mm	M14 x 2,00 mm	1	36,92
0963 1520	110 mm	30 mm	M15 x 2,00 mm	1	76,70
0963 1620	110 mm	32 mm	M16 x 2,00 mm	1	45,39
0963 1825	125 mm	34 mm	M18 x 2,50 mm	1	61,66
0963 2025	140 mm	34 mm	M20 x 2,50 mm	1	66,50
0963 2225	140 mm	34 mm	M22 x 2,50 mm	1	80,48
0963 2430	160 mm	38 mm	M24 x 3,00 mm	1	95,83
0963 2730	160 mm	38 mm	M27 x 3,00 mm	1	119,90
0963 3035	180 mm	45 mm	M30 x 3,50 mm	1	154,07

ES Para agujeros pasantes 400-800 N/mm.  
FR Pour trous pasants 400-800 N/mm.  
EN Holes assistants 400-800 N/mm.  
IT Per fori passanti 400-800 N/mm.  
PT Para furos de passo 400-800 N/mm.



**HSS E-DIN 371 FORM C**

Ref	↔	P	MxP	📦	📊
0964 0350	56 mm	11 mm	M3 x 0,50 mm	1	16,67
0964 0470	63 mm	13 mm	M4 x 0,70 mm	1	14,65
0964 0580	70 mm	16 mm	M5 x 0,80 mm	1	14,13
0964 0610	80 mm	19 mm	M6 x 1,00 mm	1	15,40
0964 0812	90 mm	22 mm	M8 x 1,25 mm	1	21,06
0964 1015	100 mm	24 mm	M10 x 1,50 mm	1	21,67

ES Para agujeros ciegos 400-800 N/mm.  
FR Pour trous bouchés 400-800 N/mm.  
EN For closed drill hole 400-800 N/mm.  
IT Per fori ciechi 400-800 N/mm.  
PT Para furos cegos 400-800 N/mm.



**HSS E-DIN 376/374 FORM C**

Ref	↔	P	MxP	📦	📊
0964 1217	75 mm	29 mm	M12 x 1,75 mm	1	28,30
0964 1420	80 mm	30 mm	M14 x 2,00 mm	1	39,68
0964 1620	80 mm	32 mm	M16 x 2,00 mm	1	47,89
0964 1825	95 mm	40 mm	M18 x 2,50 mm	1	64,41
0964 2025	95 mm	40 mm	M20 x 2,50 mm	1	68,64
0964 2225	100 mm	40 mm	M22 x 2,50 mm	1	84,71
0964 2430	110 mm	50 mm	M24 x 3,00 mm	1	103,38
0964 2730	110 mm	50 mm	M27 x 3,00 mm	1	126,58
0964 3035	125 mm	56 mm	M30 x 3,50 mm	1	162,23

ES Para agujeros ciegos 400-800 N/mm.  
FR Pour trous bouchés 400-800 N/mm.  
EN For closed drill hole 400-800 N/mm.  
IT Per fori ciechi 400-800 N/mm.  
PT Para furos cegos 400-800 N/mm.



MACHOS DE ROSCAR A MÁQUINA "INOX" / TARAUDS MACHINE INOX / MACHINE TAPS STAINLESS STEEL  
MASCHI DA MACCHINA UTENSILE INOX / MACHOS DE ENROSCAR PARA MÁQUINA "INOX"



### HSS EX-DIN 371 FORM B (INOX)

Ref	↔	P	MxP		
<b>0931 0350</b>	56 mm	11 mm	M3 x 0,50 mm	1	<b>19,63</b>
<b>0931 0470</b>	63 mm	13 mm	M4 x 0,70 mm	1	<b>19,63</b>
<b>0931 0580</b>	70 mm	16 mm	M5 x 0,80 mm	1	<b>19,63</b>
<b>0931 0610</b>	80 mm	19 mm	M6 x 1,00 mm	1	<b>21,62</b>
<b>0931 0812</b>	90 mm	22 mm	M8 x 1,25 mm	1	<b>24,63</b>
<b>0931 1015</b>	100 mm	24 mm	M10 x 1,50 mm	1	<b>28,86</b>

ES Para agujeros pasantes.  
FR Pour trous pasants.  
EN Holes assistants.  
IT Per fori passanti.  
PT Para furos de passo.



### HSS EX-DIN 376 FORM B (INOX)

Ref	↔	P	MxP		
<b>0931 1217</b>	110 mm	29 mm	M12 x 1,75 mm	1	<b>37,64</b>
<b>0931 1420</b>	110 mm	30 mm	M14 x 2,00 mm	1	<b>47,07</b>
<b>0931 1620</b>	110 mm	32 mm	M16 x 2,00 mm	1	<b>55,33</b>
<b>0931 1825</b>	125 mm	34 mm	M18 x 2,50 mm	1	<b>73,18</b>
<b>0931 2025</b>	140 mm	34 mm	M20 x 2,50 mm	1	<b>84,71</b>

ES Para agujeros pasantes.  
FR Pour trous pasants.  
EN Holes assistants.  
IT Per fori passanti.  
PT Para furos de passo.



### HSS EX-DIN 371 FORM C (INOX)

Ref	↔	P	MxP		
<b>0932 0350</b>	56 mm	11 mm	M3 x 0,50 mm	1	<b>21,79</b>
<b>0932 0470</b>	63 mm	13 mm	M4 x 0,70 mm	1	<b>21,79</b>
<b>0932 0580</b>	70 mm	16 mm	M5 x 0,80 mm	1	<b>21,79</b>
<b>0932 0610</b>	80 mm	19 mm	M6 x 1,00 mm	1	<b>21,79</b>
<b>0932 0812</b>	90 mm	22 mm	M8 x 1,25 mm	1	<b>27,34</b>
<b>0932 1015</b>	100 mm	24 mm	M10 x 1,50 mm	1	<b>33,35</b>

ES Para agujeros ciegos.  
FR Pour trous bouchés.  
EN For closed drill hole.  
IT Per fori ciechi.  
PT Para furos cegos.



### HSS EX-DIN 376 FORM C (INOX)

Ref	↔	P	MxP		
<b>0932 1217</b>	110 mm	29 mm	M12 x 1,75 mm	1	<b>45,08</b>
<b>0932 1420</b>	110 mm	30 mm	M14 x 2,00 mm	1	<b>54,98</b>
<b>0932 1620</b>	110 mm	32 mm	M16 x 2,00 mm	1	<b>66,50</b>
<b>0932 1825</b>	125 mm	34 mm	M18 x 2,50 mm	1	<b>89,40</b>
<b>0932 2025</b>	140 mm	34 mm	M20 x 2,50 mm	1	<b>95,22</b>

ES Para agujeros ciegos.  
FR Pour trous bouchés.  
EN For closed drill hole.  
IT Per fori ciechi.  
PT Para furos cegos.

**EXTRACTORES DE TORNILLOS / TOURNE A GAUCHE / SCREW EXTRACTORS / ESTRATTORE VITI / EXTRAÇÃO DE PARAFUSOS**

ES Forma de usar: En la pieza para extraer se taladrará un agujero. Seguidamente se enrosca el macho correspondiente en giro izquierdo. Seguir introduciendo el macho hasta extraer la pieza rota, no daña los pasos.

FR Utilisation: Percer un trou sur la partie souhaitée. Tourner l'extracteur vers la gauche jusqu'à extraire la vis. Les pas de vis ne sont pas endommagés.

EN Directions for use: Drill a central hole using a proper drill. Insert the screw extractor in the hole and start turning it to the left. Keep on inserting it until the broken piece is out, threads are not damaged.

IT Modalità d'uso: Eseguire un foro nel pezzo da estrarre. Avvitare il maschio corrispondente ruotando a sinistra. Continuare ad avvitare il maschio fino all'estrazione del pezzo rotto, non danneggiare i filetti.

PT Conselhos de utilização: Faça um furo central, utilizando uma broca adequada. Insira o extrator de parafuso no buraco e comece a girar para a esquerda. Continue a inseri-lo até tirar o pedaço quebrado as roscas não estão danificadas.



Ref	M		
<b>0965 0004</b>	M 0 - 4	1	<b>2,20</b>
<b>0965 0570</b>	M 5 - 7	1	<b>2,20</b>
<b>0965 0810</b>	M 8 - 10	1	<b>2,61</b>
<b>0965 1114</b>	M 11 - 14	1	<b>3,23</b>
<b>0965 1618</b>	M 16 - 18	1	<b>4,20</b>
<b>0965 1824</b>	M 18 - 24	1	<b>6,75</b>
<b>0965 2433</b>	M 24 - 33	1	<b>10,36</b>
<b>0965 3345</b>	M 33 - 45	1	<b>15,15</b>



Ref			
<b>0973 5010</b>	M 3-45 (8 pcs)	1	<b>49,22</b>
<b>0973 5011</b>	M 3-24 (6 pcs)	1	<b>23,50</b>
<b>0973 5012</b>	M 3-18 (5 pcs)	1	<b>16,65</b>

**MACHOS Y TERRAJAS EN KIT / SET DE TARAUDS ET FILIERES / TAPS AND DIES KITS / SET MASCHI E FILIERE / KIT DE MACHOS E CAÇONETES**
**ES MACHOS Y TERRAJAS EN KIT**

- Juego machos y terrajas desde métrica 3 hasta métrica 12 (0995 2810)
- Juego machos y terrajas desde métrica 3 hasta métrica 20 (0995 2811)
- Juego machos y terrajas desde métrica 5 hasta métrica 20 (0995 2812)

**FR SET DE TARAUDS ET FILIERES**

- Jeu de tarauds et filières de M-3 jusqu'à M-12. (0995 2810)
- Jeu de tarauds et filières de M-3 jusqu'à M-20 (0995 2811)
- Jeu de tarauds et filières de M-5 jusqu'à M-20 (0995 2812)

**EN TAPS AND DIES KITS**

- Taps and dies kit from metric M-3 to M-12 (0995 2810)
- Taps and dies kit from metric M-3 to M-20 (0995 2811)
- Taps and dies kit from metric M-5 to M-20 (0995 2812)

**IT SET MASCHI E FILIERE**

- Set di maschi e filiere da M-3 a M-12 (0995 2810)
- Set di maschi e filiere da M-3 a M-20 (0995 2811)
- Set di maschi e filiere da M-5 a M-20 (0995 2812)

**PT KIT DE MACHOS E CAÇONETES**

- Jogo de machos e caçonetes desde métrica 3 até métrica 12 (0995 2810)
- Jogo de machos e caçonetes desde métrica 3 até métrica 20 (0995 2811)
- Jogo de machos e caçonetes desde métrica 5 até métrica 20 (0995 2812)

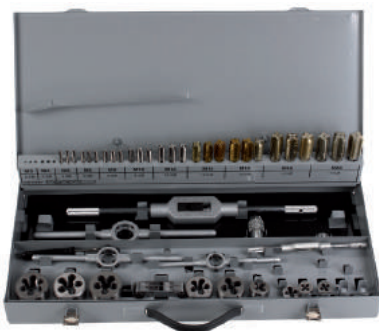

Ref			
<b>0995 2810</b>	M 3-4-5-6-8-10-12	1	<b>212,87</b>
<b>0995 2811</b>	M 3-4-5-6-8-10-12-14-16-18-20	1	<b>623,02</b>
<b>0995 2812</b>	M 5-6-8-10-12-14-16-18-20	1	<b>591,83</b>





GIRAMACHOS / TARAUDS ROTATIFS / TAP WRENCH / GIRAMASCHIO / DESANDADOR DE MACHOS

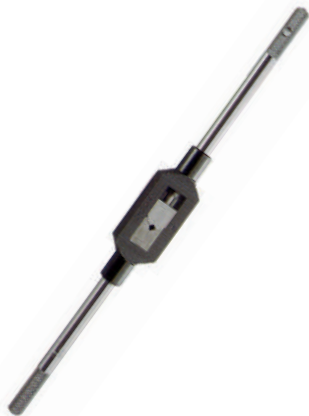

Ref	Ø	NUMBER		
0997 2580	M-1, M-10	1	1	18,70
0997 4912	M-4, M-12	2	1	27,44
0997 0720	M-5, M-20	3	1	36,00
0997 1027	M-10, M-27	4	1	57,48
0997 1332	M-13, M-32	5	1	120,82
0997 1842	M-18, M-42	6	1	120,82
0997 2552	M-25, M-52	7	1	209,46

GIRAMACHOS DE CARRACA EN "T" / TARAUDS ROTATIFS EN "T" / "T" TAP WRENCH / GIRAMASCHIO A "T" / DESANDADOR COM ROQUETE



Ref	Ø		
0998 2655	M-3, M-10	1	21,93
0998 4608	M-5, M-12	1	28,61
0998 1320	M-13, M-20	1	110,92

VOLVEDORES DE 3 TORNILLOS / TOURNE-À-GAUCHE À 3 VIS / 3 SCREWS DIE HOLDERS  
GIRA FEMMINA A 3 VITI / DESANDADOR PARA CAÇONETES 3 PARAFUSOS



Ref	Ø		
0999 2007	20 mm	1	10,81
0999 2509	25 mm	1	11,87
0999 3011	30 mm	1	15,30
0999 3814	38 mm	1	17,82
0999 4518	45 mm	1	21,89
0999 5500	55 mm	1	28,10
0999 6500	65 mm	1	42,04
0999 7530	75 mm	1	75,84
0999 9036	90 mm	1	96,49

**PUNZÓN TALADRO ELECTROMAGNÉTICO/ POINÇON POUR PERCEUSE ÉLECTROMAGNÉTIQUE  
PILOT PIN FOR ELECTROMAGNETIC DRILL / PUNZONE TRAPANO ELETTRMAGNETICO  
PUNÇÃO BERBEQUIM ELETROMAGNÉTICO**

PUNZÓN TALADRO ELECTROMAGNÉTICO/ POINÇON POUR PERCEUSE ÉLECTROMAGNÉTIQUE / PILOT PIN FOR ELECTROMAGNETIC DRILL  
PUNZONE TRAPANO ELETTRMAGNETICO / PUNÇÃO BERBEQUIM ELETROMAGNÉTICO



Ref	↔	Ø		
0961 0001	77 mm	6,35 mm	1	21,93
0961 0002	102 mm	6,35 mm	1	21,93



CORONA HSS TALADRO ELECTROMAGNÉTICO / COURONNE HSS PERCEUSE ELECTRO-MAGNETIQUE / HSS HOLE SAW FOR ELECTROMAGNETIC DRILL  
CORONA HSS TRAPANO ELETTROMAGNETICO / SERRA CRANEANA HSS BERBEQUIM ELETROMAGNÉTICO



Ref	A	Ø <sub>B</sub>	Ø <sub>C</sub>		
0961 1230	30	12	19,05 mm	1	37,78
0961 1330	30	13	19,05 mm	1	37,78
0961 1430	30	14	19,05 mm	1	38,77
0961 1530	30	15	19,05 mm	1	40,35
0961 1630	30	16	19,05 mm	1	41,77
0961 1730	30	17	19,05 mm	1	43,35
0961 1830	30	18	19,05 mm	1	48,75
0961 1930	30	19	19,05 mm	1	49,69
0961 2030	30	20	19,05 mm	1	51,75
0961 2130	30	21	19,05 mm	1	55,39
0961 2230	30	22	19,05 mm	1	57,79
0961 2330	30	23	19,05 mm	1	59,85
0961 2430	30	24	19,05 mm	1	62,07
0961 2530	30	25	19,05 mm	1	64,17
0961 2630	30	26	19,05 mm	1	65,97
0961 2730	30	27	19,05 mm	1	71,16
0961 2830	30	28	19,05 mm	1	71,24
0961 2930	30	29	19,05 mm	1	73,85
0961 3030	30	30	19,05 mm	1	75,74
0961 3130	30	31	19,05 mm	1	82,64
0961 3230	30	32	19,05 mm	1	92,96
0961 3330	30	33	19,05 mm	1	94,25
0961 3430	30	34	19,05 mm	1	109,84
0961 3530	30	35	19,05 mm	1	121,06
0961 3630	30	36	19,05 mm	1	124,06

Ref	A	Ø <sub>B</sub>	Ø <sub>C</sub>		
0961 3730	30	37	19,05 mm	1	131,22
0961 3830	30	38	19,05 mm	1	133,06
0961 3930	30	39	19,05 mm	1	138,12
0961 4030	30	40	19,05 mm	1	141,46
0961 4130	30	41	19,05 mm	1	147,24
0961 4230	30	42	19,05 mm	1	155,21
0961 4330	30	43	19,05 mm	1	158,55
0961 4430	30	44	19,05 mm	1	169,82
0961 4530	30	45	19,05 mm	1	175,34
0961 4630	30	46	19,05 mm	1	178,94
0961 4730	30	47	19,05 mm	1	184,94
0961 4830	30	48	19,05 mm	1	193,72
0961 4930	30	49	19,05 mm	1	196,63
0961 5030	30	50	19,05 mm	1	201,52
0961 5130	30	51	19,05 mm	1	202,72
0961 5230	30	52	19,05 mm	1	204,09
0961 5330	30	53	19,05 mm	1	205,42
0961 5430	30	54	19,05 mm	1	208,93
0961 5530	30	55	19,05 mm	1	213,21
0961 5630	30	56	19,05 mm	1	217,88
0961 5730	30	57	19,05 mm	1	222,38
0961 5830	30	58	19,05 mm	1	227,18
0961 5930	30	59	19,05 mm	1	232,02
0961 6030	30	60	19,05 mm	1	236,30

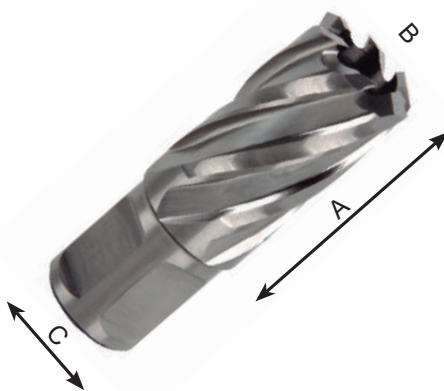

Ref	A	Ø <sub>B</sub>	Ø <sub>C</sub>		
0961 1250	50	12	19,05 mm	1	58,56
0961 1350	50	13	19,05 mm	1	59,76
0961 1450	50	14	19,05 mm	1	62,46
0961 1550	50	15	19,05 mm	1	62,85
0961 1650	50	16	19,05 mm	1	63,06
0961 1750	50	17	19,05 mm	1	64,86
0961 1850	50	18	19,05 mm	1	71,88
0961 1950	50	19	19,05 mm	1	74,16
0961 2050	50	20	19,05 mm	1	77,67
0961 2150	50	21	19,05 mm	1	83,23
0961 2250	50	22	19,05 mm	1	85,98
0961 2350	50	23	19,05 mm	1	91,68
0961 2450	50	24	19,05 mm	1	94,63
0961 2550	50	25	19,05 mm	1	94,93
0961 2650	50	26	19,05 mm	1	97,37
0961 2750	50	27	19,05 mm	1	101,87
0961 2850	50	28	19,05 mm	1	106,33
0961 2950	50	29	19,05 mm	1	110,74
0961 3050	50	30	19,05 mm	1	115,62
0961 3150	50	31	19,05 mm	1	121,23
0961 3250	50	32	19,05 mm	1	126,76
0961 3350	50	33	19,05 mm	1	133,06
0961 3450	50	34	19,05 mm	1	138,12
0961 3550	50	35	19,05 mm	1	143,81
0961 3650	50	36	19,05 mm	1	150,41

Ref	A	Ø <sub>B</sub>	Ø <sub>C</sub>		
0961 3750	50	37	19,05 mm	1	152,81
0961 3850	50	38	19,05 mm	1	158,55
0961 3950	50	39	19,05 mm	1	169,82
0961 4050	50	40	19,05 mm	1	182,24
0961 4150	50	41	19,05 mm	1	184,21
0961 4250	50	42	19,05 mm	1	194,32
0961 4350	50	43	19,05 mm	1	200,23
0961 4450	50	44	19,05 mm	1	205,71
0961 4550	50	45	19,05 mm	1	237,38
0961 4650	50	46	19,05 mm	1	254,77
0961 4750	50	47	19,05 mm	1	271,86
0961 4850	50	48	19,05 mm	1	280,60
0961 4950	50	49	19,05 mm	1	283,39
0961 5050	50	50	19,05 mm	1	284,80
0961 5150	50	51	19,05 mm	1	285,40
0961 5250	50	52	19,05 mm	1	286,86
0961 5350	50	53	19,05 mm	1	288,48
0961 5450	50	54	19,05 mm	1	293,88
0961 5550	50	55	19,05 mm	1	297,95
0961 5650	50	56	19,05 mm	1	299,75
0961 5750	50	57	19,05 mm	1	306,77
0961 5850	50	58	19,05 mm	1	308,36
0961 5950	50	59	19,05 mm	1	313,55
0961 6050	50	60	19,05 mm	1	316,54



**CORONAS DE METAL DURO / COURONNES METALLIQUES / CARBIDE TIPPED HOLE SAWS  
CORONA IN METALLO DURO / SERRA CRANEANA METAL DURO**



ES Coronas con placas de metal duro soldadas, afiladas y rectificadas. Contienen canal de evacuación para virutas. Con limitador de profundidad. Se puede aplicar en superficies planas y curvas. Espesores máximos de hasta 20 mm.

FR Couronnes avec plaques de métal dur soudé, effilé et rectifié. Avec canal d'évacuation pour tournure. Avec limiteur de profondeur. Peut être appliqué sur des surfaces plates et courbées. Epaisseur maximum de 20 mm.

EN Crown drills with hard metal welded sheets, sharpened and grounded. Better chipping-off. Guide drill with spring. Ideal to be used on flat and curved surfaces. Thickness up to 20 mm.

IT Corone con inserti di metallo duro saldati, affilati e rettificati. Con canale di evacuazione del truciolo. Con limitatore di profondità. Utilizzare su superfici piane e curve. Spessore massimo fino a 20 mm.

PT Com chapas de metal duro soldadas, afiadas e rectificadas. Contém canal de evacuação para lascas. Guia de broca com mola. Ideal para ser utilizado em superfícies planas e curvas. Espessura de até 20 mm.

Ref	Ø		
0971 1018	18 mm	1	73,88
0971 1019	19 mm	1	72,16
0971 1020	20 mm	1	72,16
0971 1021	21 mm	1	74,37
0971 1022	22 mm	1	74,37
0971 1023	23 mm	1	75,48
0971 1024	24 mm	1	75,48
0971 1025	25 mm	1	75,48
0971 1026	26 mm	1	79,91
0971 1027	27 mm	1	81,01
0971 1028	28 mm	1	81,01
0971 1029	29 mm	1	81,01
0971 1030	30 mm	1	81,01
0971 1031	31 mm	1	95,49
0971 1032	32 mm	1	95,49
0971 1033	33 mm	1	98,81
0971 1034	34 mm	1	99,87
0971 1035	35 mm	1	99,87
0971 1036	36 mm	1	101,02
0971 1038	38 mm	1	101,02
0971 1039	39 mm	1	102,13
0971 1040	40 mm	1	102,13
0971 1041	41 mm	1	120,99
0971 1042	42 mm	1	120,99
0971 1043	43 mm	1	124,35
0971 1044	44 mm	1	124,35
0971 1045	45 mm	1	124,35
0971 1046	46 mm	1	128,78
0971 1048	48 mm	1	128,78
0971 1049	49 mm	1	129,85
0971 1050	50 mm	1	129,85
0971 1051	51 mm	1	149,85
0971 1052	52 mm	1	149,85
0971 1053	53 mm	1	150,96
0971 1055	55 mm	1	150,96
0971 1056	56 mm	1	165,39
0971 1057	57 mm	1	165,39
0971 1058	58 mm	1	165,39
0971 1059	59 mm	1	167,61
0971 1061	61 mm	1	188,68
0971 1062	62 mm	1	188,68
0971 1063	63 mm	1	188,68
0971 1064	64 mm	1	188,68
0971 1065	65 mm	1	188,68
0971 1066	66 mm	1	205,36
0971 1067	67 mm	1	205,36
0971 1068	68 mm	1	207,58
0971 1069	69 mm	1	207,58
0971 1070	70 mm	1	207,58
0971 1075	75 mm	1	216,48
0971 1080	80 mm	1	225,34
0971 1085	85 mm	1	227,55
0971 1090	90 mm	1	239,77
0971 1095	95 mm	1	243,09
0971 1100	100 mm	1	274,73



CORONAS HSS REAFILABLES / COURONNES HSS AIGUISABLES / HSS HOLE SAWS, POSSIBILITY OF RE-SHARPENING  
CORONE HSS RIAFFILABILI / SERRAS CRANEANAS HSS AFIADAS



ES Coronas reafilables en acero rápido rectificado M2 con rompevirutas y husillo incorporado.  
FR Couronnes aiguisables en acier rapide retifié M2 avec brise tournure et broche incorporée.  
EN Crown drill made from high-speed steel M2 with built-in spindle.  
IT Corone riaffilabili in acciaio rapido rettificato M2 con spezzatruciolo e supporto incorporato.  
PT Serras afiadas em aço rápido retificado M2 com rompedor e fuso incorporado.

Ref	Ø				Ref	Ø				Ref	Ø			
0980 2010	10 mm	1	17,30	✓	0980 2032	32 mm	1	36,85	✓	0980 2054	54 mm	1	77,75	✓
0980 2011	11 mm	1	18,22	✓	0980 2033	33 mm	1	38,02	✓	0980 2055	55 mm	1	79,21	✓
0980 2012	12 mm	1	19,22	✓	0980 2034	34 mm	1	39,17	✓	0980 2056	56 mm	1	80,64	✓
0980 2013	13 mm	1	20,17	✓	0980 2035	35 mm	1	40,32	✓	0980 2057	57 mm	1	83,20	✓
0980 2014	14 mm	1	20,72	✓	0980 2036	36 mm	1	41,47	✓	0980 2058	58 mm	1	83,52	✓
0980 2015	15 mm	1	21,41	✓	0980 2037	37 mm	1	42,60	✓	0980 2059	59 mm	1	84,98	✓
0980 2016	16 mm	1	21,91	✓	0980 2038	38 mm	1	43,70	✓	0980 2060	60 mm	1	86,40	✓
0980 2017	17 mm	1	22,29	✓	0980 2039	39 mm	1	44,94	✓	0980 2061	61 mm	1	99,57	✓
0980 2018	18 mm	1	22,56	✓	0980 2040	40 mm	1	46,09	✓	0980 2062	62 mm	1	101,18	✓
0980 2019	19 mm	1	22,75	✓	0980 2041	41 mm	1	47,23	✓	0980 2063	63 mm	1	102,84	✓
0980 2020	20 mm	1	23,03	✓	0980 2042	42 mm	1	48,38	✓	0980 2064	64 mm	1	104,44	✓
0980 2021	21 mm	1	24,17	✓	0980 2043	43 mm	1	49,56	✓	0980 2065	65 mm	1	106,08	✓
0980 2022	22 mm	1	25,35	✓	0980 2044	44 mm	1	50,70	✓	0980 2066	66 mm	1	107,73	✓
0980 2023	23 mm	1	26,50	✓	0980 2045	45 mm	1	51,85	✓	0980 2067	67 mm	1	109,34	✓
0980 2024	24 mm	1	27,65	✓	0980 2046	46 mm	1	53,00	✓	0980 2068	68 mm	1	112,47	✓
0980 2025	25 mm	1	28,79	✓	0980 2047	47 mm	1	54,14	✓	0980 2069	69 mm	1	112,62	✓
0980 2026	26 mm	1	29,94	✓	0980 2048	48 mm	1	55,29	✓	0980 2070	70 mm	1	114,27	✓
0980 2027	27 mm	1	31,12	✓	0980 2049	49 mm	1	56,47	✓	0980 2075	75 mm	1	123,87	✓
0980 2028	28 mm	1	32,26	✓	0980 2050	50 mm	1	57,61	✓	0980 2080	80 mm	1	130,57	✓
0980 2029	29 mm	1	33,40	✓	0980 2051	51 mm	1	73,45	✓	0980 2085	85 mm	1	150,70	✓
0980 2030	30 mm	1	34,55	✓	0980 2052	52 mm	1	74,87	✓	0980 2090	90 mm	1	158,42	✓
0980 2031	31 mm	1	35,71	✓	0980 2053	53 mm	1	76,33	✓	0980 2095	95 mm	1	168,00	✓
										0980 2100	100 mm	1	177,61	✓

BROCA GUÍA CORONAS / FORET GUIDE COURONNES / CENTERING DRILL BIT / PUNTA GUIDA CORONE / BROCA DE CENTRAR



Ref	Ø		
0980 1993	10 - 13 mm	1	2,59
0980 1994	14 - 50 mm	1	2,77
0980 1995	51 - 100 mm	1	2,95

HUSILLO CON BROCA CORONAS / MANDRIN AVEC FORET COURONNES / SPINDLE WITH DRILL  
SUPPORTO CON PUNTA CORONE / ADAPTADOR SERRA CRANEANA



Ref	Ø		
0980 1990	17 - 25 mm	1	8,50
0980 1991	26 - 50 mm	1	9,07
0980 1992	51 - 100 mm	1	10,99



**CORONAS BIMETÁLICAS / COURONNES BIMETALLIQUES / BI-METAL HOLE SAWS / CORONE BIMETALLICHE / SERRA CRANEANA BIMETÁLICA**



ES Corona bimetalica con dentado en acero rápido con 8% de cobalto (M42). APLICACIONES: Hierro, aceros, latón, bronce, aluminio, madera, etc.

FR Couronnes bimétalliques dentées en acier rapide avec 8% de cobalt (M42). APPLICATIONS: Fer acier, laiton, bronze, aluminium, bois, etc.

EN Bi-metal hole saws HSS jagged, 8% of cobalt (M42). APPLICATIONS: Iron, steels, brass, bronze, aluminium, wood, etc.

IT Corone bimetalliche, dentatura in acciaio rapido con l'8% di cobalto (M42). APPLICAZIONI: Ferro, acciaio, latta, bronzo, alluminio, legno, etc.

PT Serra bi metálica, dentada, em aço rápido com 8% de cobalto (M42). APLICAÇÕES: ferro, aço, latão, bronze, alumínio, madeira, etc.

Ref	Ø	📦	📦	📦	Ref	Ø	📦	📦	📦	Ref	Ø	📦	📦	📦	Ref	Ø	📦	📦	📦
0980 0014	14 mm	1	15,22	✓	0980 0037	37 mm	1	18,22	✓	0980 0064	64 mm	1	29,19	✓	0980 0105	105 mm	1	45,03	✓
0980 0016	16 mm	1	15,22	✓	0980 0038	38 mm	1	18,22	✓	0980 0065	65 mm	1	29,19	✓	0980 0108	108 mm	1	57,83	✓
0980 0017	17 mm	1	15,22	✓	0980 0040	40 mm	1	18,22	✓	0980 0067	67 mm	1	29,19	✓	0980 0111	111 mm	1	68,34	✓
0980 0019	19 mm	1	15,22	✓	0980 0041	41 mm	1	18,22	✓	0980 0068	68 mm	1	29,19	✓	0980 0114	114 mm	1	79,76	✓
0980 0020	20 mm	1	15,22	✓	0980 0043	43 mm	1	18,22	✓	0980 0070	70 mm	1	29,19	✓	0980 0121	121 mm	1	88,63	✓
0980 0021	21 mm	1	15,22	✓	0980 0044	44 mm	1	22,29	✓	0980 0073	73 mm	1	29,19	✓	0980 0127	127 mm	1	98,23	✓
0980 0022	22 mm	1	15,22	✓	0980 0046	46 mm	1	22,29	✓	0980 0076	76 mm	1	29,81	✓	0980 0140	140 mm	1	117,76	✓
0980 0024	24 mm	1	15,22	✓	0980 0048	48 mm	1	22,29	✓	0980 0079	79 mm	1	29,81	✓	0980 0152	152 mm	1	137,50	✓
0980 0025	25 mm	1	16,18	✓	0980 0050	50 mm	1	22,29	✓	0980 0083	83 mm	1	29,81	✓	0980 0160	160 mm	1	212,47	✓
0980 0027	27 mm	1	17,14	✓	0980 0051	51 mm	1	22,29	✓	0980 0086	86 mm	1	29,81	✓	0980 0168	168 mm	1	233,48	✓
0980 0029	29 mm	1	17,14	✓	0980 0052	52 mm	1	26,37	✓	0980 0089	89 mm	1	29,81	✓	0980 0177	177 mm	1	237,81	✓
0980 0030	30 mm	1	17,14	✓	0980 0054	54 mm	1	26,37	✓	0980 0092	92 mm	1	34,57	✓	0980 0210	210 mm	1	251,33	✓
0980 0032	32 mm	1	17,14	✓	0980 0057	57 mm	1	26,37	✓	0980 0095	95 mm	1	40,14	✓					
0980 0033	33 mm	1	17,14	✓	0980 0059	59 mm	1	26,37	✓	0980 0098	98 mm	1	44,68	✓					
0980 0035	35 mm	1	18,22	✓	0980 0060	60 mm	1	26,37	✓	0980 0102	102 mm	1	44,68	✓					

**HUSILLOS PORTACORONAS BIMETÁLICAS CON BROCA / MANDRIN AVEC FORET INTERCHANGEABLE / SPINDLE WITH DRILL  
SUPPORTO PORTACORONA CON PUNTA / ADAPTADOR PARA SERRA CRANEANA COM BROCA**



Ref	Ø	📦	📦
0981 1430	14 - 30 mm	1	14,91
0981 32152	32 - 250 mm	1	29,69

**HUSILLO PORTACORONAS BIMETÁLICAS CON BROCA SDS PLUS / MANDRIN AVEC FORET INTERCHANGEABLE / SPINDLE WITH DRILL SDS PLUS  
SUPPORTO PORTACORONA CON PUNTA SDS PLUS / ADAPTADOR SERRA CRANEANA COM BROCA SDS PLUS**



Ref	Ø	📦	📦
0981 0014	14 - 30 mm	1	14,91
0981 0032	32 - 250 mm	1	35,47

**BROCA DE CENTRAR / FORET GUIDE POUR COURONNES BIMETALLIQUES / CENTERING DRILL BIT / PUNTA DI CENTRAGGIO / BROCA DE CENTRAR**



Ref	Ø	📦	📦
0981 0001	6,4 mm	1	4,71





MALETINES DE CORONAS BIMETÁLICAS / MALETTE DES SCIES TREPAN BIMETALLIQUES / SET OF BI-METAL HOLE SAWS  
SET CORONE RIAFFILABILI E BIMETALLICHE / CONJUNTOS DE SERRAS CRANEANAS BIMETÁLICAS



Ref			↓	↓	↓
0450 0981	ESTÁNDAR		25-35-43-51-64	1	185,18
0450 0982	ELECTRICISTA		19-21-24-29-38-48	1	210,85
0450 0983	INDUSTRIAL		19-22-25-32-35-38-43-51-57-60-64-76+extension 330 mm	1	364,05
0450 0984	FONTANERÍA		22-25-33-35-41-51	1	214,26

EXPOSITOR CORONAS / PRESENTOIR COURONNE / HOLE SAWS DISPLAY STAND / ESPOSITORE CORONE / EXPOSITOR PARA SERRAS CRANEANAS

Contenido / Contenu / Contents / Contenuto / Conteúdo



Ø	↓
14 mm	2
19 mm	2
22 mm	2
25 mm	2
32 mm	2
35 mm	2
38 mm	2
44 mm	2
51 mm	2
57 mm	2
64 mm	2
70 mm	2

Ø	↓
14-30	2
32-250	2

Ø	↓
14-30	2
32-250	2

Ref	↓	↓
0980 0099	1	690,27

SIERRAS / SIE / SAW / SEGHE / SERRAS

SIERRA DE CALAR / LAME-SCIE SAUTEUSE / JIGSAW BLADES / LAME-SEGHE TICO-TICO / LÂMINAS DE SERRA TICO-TICO



MADERA / WOOD

Ref	Ad. BOSCH	QUALITY	↔	PACK	pack
2050 1001	T111C	HCS	75 x 3	5 uds	8,05
2050 1002	T144D	HCS	75 x 4-5,2	5 uds	8,57
2050 1 003	T244D	HCS	75 x 4-5,2	5 uds	9,77
2050 1004	T344D	HCS	125 x 4	5 uds	13,59



MADERA · AGLOMERADO / WOOD

Ref	Ad. BOSCH	QUALITY	↔	PACK	pack
2050 1006	T101D	HCS	75 x 4-5,2	5 uds	11,27
2050 1008	T301CD	HCS	90 x 3	5 uds	14,78
2050 1009	T101DP	HCS	75 x 4	5 uds	12,73



SIERRA DE CALAR / LAME-SCIE SAUTEUSE / JIGSAW BLADES / LAME-SEGHETTO ALT / LÂMINAS DE SERRA TICO-TICO

## SUPERIOR MADERA / WOOD



Ref	Ad. BOSCH	QUALITY	↔	PACK	pack
2050 1013	T141HM	HM	75 x 4,3	1 ud	22,45

MADERA · ALU · CU · N  
WOOD · ALU · CU · N

Ref	Ad. BOSCH	QUALITY	↔	PACK	pack
2050 1014	T345XF	BIMETAL	105 x 2,4-5	1 ud	27,20

MADERA · PLÁSTICO · PVC  
WOOD · PVC

Ref	Ad. BOSCH	QUALITY	↔	PACK	pack
2050 1005	T101B	HCS	75 x 2,7	5 uds	11,27
2050 1007	T101BR	HCS	75 x 2,5	5 uds	11,83
2050 1010	T234X	HCS	93 x 2-3	5 uds	18,30
2050 1011	T308B	HCS	93 x 2,2	5 uds	18,90
2050 1012	T101AIF	BIMETAL	75 x 1,6	5 uds	20,70

METAL · ALUMINIO  
STEEL · ALUMINIUM

Ref	Ad. BOSCH	QUALITY	↔	PACK	pack
2050 2001	T318A	HSS	105 x 1,2	5 uds	15,94

METAL · INOX  
STEEL · INOX

Ref	Ad. BOSCH	QUALITY	↔	PACK	pack
2050 2009	T118AHM	HM	60 x 1,1	1 ud	17,44



SIERRA DE CALAR / LAME-SCIE SAUTEUSE / JIGSAW BLADES / LAME-SEGHETTO ALT / LÂMINAS DE SERRA TICO-TICO

**METAL / STEEL**

Ref	Ad. BOSCH	QUALITY	↔	PACK	pack
<b>2050 2002</b>	T118A	HSS	67 x 1,1 - 1,5	5 uds	<b>11,27</b>
<b>2050 2003</b>	T118B	HSS	67 x 1,9 - 2,3	5 uds	<b>11,27</b>

**SUPERIOR METAL / STEEL**

Ref	Ad. BOSCH	QUALITY	↔	PACK	pack
<b>2050 2006</b>	T321AF	BIMETAL	105 x 1,2	5 uds	<b>21,30</b>
<b>2050 2007</b>	T118AF	BIMETAL	67 x 1,1-1,5	5 uds	<b>15,38</b>
<b>2050 2008</b>	T118BF	BIMETAL	67 x 1,9-2,3	5 uds	<b>15,38</b>

**Cu · Ni · Ns · Zn · PVC**

Ref	Ad. BOSCH	QUALITY	↔	PACK	pack
<b>2050 2004</b>	T127D	HSS	75 x 3,0	5 uds	<b>11,82</b>

**METAL · ALUMINIO  
STEEL · ALUMINIUM**

Ref	Ad. BOSCH	QUALITY	↔	PACK	pack
<b>2050 2005</b>	T123X	BIMETAL	77 x 1,2-2,6	5 uds	<b>14,87</b>

**GRES · CERÁMICA · CFK**

Ref	Ad. BOSCH	QUALITY	↔	PACK	pack
<b>2050 3001</b>	.	HM	75 x 1-2	1 ud	<b>8,11</b>



SIERRAS DE CINTA / SCIES A RUBAN / BAND SAW BLADES / SEGA A CINGHIA / SERRAS DE FITA



ES SIERRA DE CINTA BIMETAL. APLICACIONES: Hierro, acero y acero inoxidable.

CARACTERÍSTICAS: Dentado variable. Ángulo corte positivo 10 grados. Dureza de 68-69 HRC. M42 8% Cobalto. Corte de secciones huecas y macizas. Referencias según su dentado, anchura y grosor.

FR SCIE À RUBAN BIMÉTALLIQUE. APPLICATIONS: Fer, acier et acier inoxydable.

CARACTERISTIQUES: Dentée variable. Angle coupe + 10 degrés 68-69 HRC. M42 8% cobalt. Coupe de sections creuses et massives. References selon dents, largeur et grosseur.

EN BIMETAL SAW TAPE. APPLICATION: Iron, steel and stainless steel.

CHARACTERISTICS: Variable gear. Positive angle + 10 grades. Hardness 68-69 HRC. M42 8% cobalt. References according to the gear design, width and thickness.

IT SEGA A CINGHIA BIMETALLICA. APPLICAZIONI: Ferro, acciaio, legno.

CARATTERISTICHE: Dentatura variabile. Angolo di taglio positivo +10° Durezza di 68-69 HRC. M42 8% cobalto. Codice secondo dentatura, larghezza e spessore.

PT SERRAS DE FITA BIMETÁLICAS. APLICAÇÕES: Ferro, aço e aço inoxidável. CARACTERÍSTICAS: Dentado variável. Ângulo de corte positivo 10 graus. Dureza 68-69 HRC. M42 8% de cobalto. Referências de acordo com o Design Engrenagem, largura e grossura.

Ref	↔	📦	▲▲▲	📦	📦
2042 1325	1325 mm	13 x 0,6 mm	8/12	1	29,73
2042 1330	1330 mm	13 x 0,6 mm	8/12	1	29,83
2042 1638	1638 mm	13 x 0,6 mm	8/12	1	34,23
2041 2070	2070 mm	27 x 0,9 mm	6/10	1	46,80
2045 2080	2080 mm	27 x 0,9 mm	8/12	1	46,97
2038 2450	2450 mm	27 x 0,9 mm	5/8	1	53,64
2041 2450	2450 mm	27 x 0,9 mm	6/10	1	53,64
2045 2450	2450 mm	27 x 0,9 mm	8/12	1	53,64
2041 2480	2480 mm	27 x 0,9 mm	6/10	1	54,21
2045 2480	2480 mm	27 x 0,9 mm	8/12	1	54,21
2041 2600	2600 mm	27 x 0,9 mm	6/10	1	56,35
2045 2600	2600 mm	27 x 0,9 mm	8/12	1	56,35
2041 2700	2700 mm	27 x 0,9 mm	6/10	1	58,16
2038 2750	2750 mm	27 x 0,9 mm	5/8	1	59,06
2041 2750	2750 mm	27 x 0,9 mm	6/10	1	59,06
2045 2750	2750 mm	27 x 0,9 mm	8/12	1	59,06
2041 2825	2825 mm	27 x 0,9 mm	6/10	1	60,43
2045 2825	2825 mm	27 x 0,9 mm	8/12	1	63,45
2041 3010	3010 mm	27 x 0,9 mm	6/10	1	63,75
2041 3100	3100 mm	27 x 0,9 mm	6/10	1	65,38
2045 3100	3100 mm	27 x 0,9 mm	8/12	1	65,38
2045 3150	3150 mm	27 x 0,9 mm	8/12	1	66,29
2041 3180	3180 mm	27 x 0,9 mm	6/10	1	66,83
2045 3660	3660 mm	27 x 0,9 mm	8/12	1	77,74
2041 4570	4570 mm	27 x 0,9 mm	6/10	1	91,92

EJEMPLO DE REFERENCIAS / EXEMPLE DE RÉFÉRENCES / EXAMPLE OF REFERENCES / ESEMPI DI RIFERIMENTI / EXEMPLO DE REFERÊNCIAS

Ref	📦	▲▲▲
2035 + Longitud	20 x 0,9 mm	4/6
2036 + Longitud	27 x 0,9 mm	4/6
2037 + Longitud	20 x 0,9 mm	5/8
2038 + Longitud	27 x 0,9 mm	5/8
2039 + Longitud	13 x 0,6 mm	6/10
2040 + Longitud	20 x 0,9 mm	6/10
2041 + Longitud	27 x 0,9 mm	6/10
2042 + Longitud	13 x 0,6 mm	8/12
2043 + Longitud	13 x 0,9 mm	8/12
2044 + Longitud	20 x 0,9 mm	8/12
2045 + Longitud	27 x 0,9 mm	8/12

ES Referencias según su dentado, anchura y grosor.

FR References selon dents, largeur et grosseur.

EN References according to the gear design, width and thickness.

IT Codice secondo dentatura, larghezza e spessore.

PT Referências de acordo com o design da engrenagem, largura e espessura.



**CORONAS PARA CONSTRUCCIÓN SDS-PLUS / SCIE CLOCHE (BATIMENT) / CONSTRUCTION LIGHT HOLLOW CORE BIT SDS PLUS  
CORONA DA COSTRUZIONI SDS PLUS E NORMALI / SERRA CRANEANA PARA CONSTRUÇÃO SDS-PLUS**



ES Corona con dientes de carburo al tungsteno para taladros percutores y de martillo. APLICACIONES: Hormigón, granito, cemento, ladrillo, etc.

FR Couronne avec dents de carbure au tungstène pour perceurs et marteaux. APPLICATIONS: Béton, granit, ciment, briques, etc.

EN Tungsten carbide teeth hole saw for tapping and hammering drills. APPLICATIONS: Concrete, granite, cement, tile, etc.

IT Corona con denti al carburo di tungsteno per martelli a percussione e normali. APPLICAZIONE: Cemento, granito, calcestruzzo, mattoni, etc.

PT Com dentes de carboneto de tungstênio para brocas de percussão. APLICAÇÕES: Betão, granito, cimento, tijolos, etc.

Ref	∅	↔	▲▲	🔩	📦	📊	👍
<b>0983 0025</b>	25 mm	72 mm	4	M16	1	<b>56,73</b>	✓
<b>0983 0030</b>	30 mm	72 mm	6	M16	1	<b>61,87</b>	✓
<b>0983 0035</b>	35 mm	72 mm	6	M16	1	<b>65,72</b>	✓
<b>0983 0040</b>	40 mm	72 mm	6	M16	1	<b>71,67</b>	✓
<b>0983 0050</b>	50 mm	72 mm	6	M16	1	<b>82,17</b>	✓
<b>0983 0068</b>	68 mm	72 mm	6	M16	1	<b>93,18</b>	✓
<b>0983 0082</b>	82 mm	72 mm	6	M16	1	<b>119,01</b>	✓
<b>0983 0090</b>	90 mm	72 mm	6	M16	1	<b>140,14</b>	✓
<b>0983 0100</b>	100 mm	72 mm	6	M16	1	<b>157,64</b>	✓
<b>0983 0112</b>	112 mm	72 mm	6	M16	1	<b>191,54</b>	✓

**CORONAS DIAMANTE PARA LADRILLO / FORET DE DIAMANT POUR BRIQUE / DIAMOND CORE DRILL FOR BRICKS  
FORETTI DIAMANTATI PER MATTONI / SERRA CRANEANA DIAMANTE PARA TIJOLO**

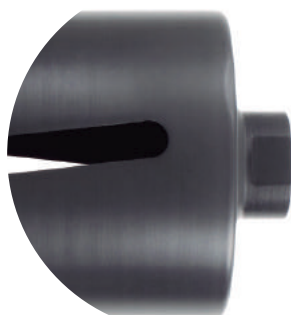

Ref	∅	↔	🔩	📦	📊
<b>1019 1038</b>	38 mm	150 mm	M-16	1	<b>108,65</b>
<b>1019 1048</b>	48 mm	150 mm	M-16	1	<b>110,50</b>
<b>1019 1051</b>	51 mm	150 mm	M-16	1	<b>112,40</b>
<b>1019 1068</b>	68 mm	150 mm	M-16	1	<b>118,49</b>
<b>1019 1078</b>	78 mm	150 mm	M-16	1	<b>129,56</b>
<b>1019 1092</b>	92 mm	150 mm	M-16	1	<b>139,20</b>
<b>1019 1107</b>	107 mm	150 mm	M-16	1	<b>171,40</b>
<b>1019 1117</b>	117 mm	150 mm	M-16	1	<b>182,45</b>
<b>1019 1127</b>	127 mm	150 mm	M-16	1	<b>201,72</b>
<b>1019 1132</b>	132 mm	150 mm	M-16	1	<b>217,75</b>
<b>1019 1152</b>	152 mm	150 mm	M-16	1	<b>235,80</b>
<b>1019 1162</b>	162 mm	150 mm	M-16	1	<b>278,19</b>





MANGO PORTACORONAS PARA TALADROS PERCUTORES / MANCHE POUR PERCEUSE A PERCUSSION / HEXAGON SHANK  
MANICO PER MARTELLI A PERCUSSIONE / ADAPTADOR HEXAGONAL



Ref	↔	⊕	📦	📊	🏷️
0983 0001	78 mm	M16	1	31,70	✓
0983 0002	220 mm	M16	1	44,09	✓
0983 0003	370 mm	M16	1	54,03	✓

MANGO PARA TALADROS ANCLAJE SDS PLUS / MANCHE POUR PERCEUSE SDS PLUS / SDS PLUS SHANK  
MANICO PER MARTELLI CON AGGANCIAMENTO SDS PLUS / ADAPTADOR SDS PLUS



Ref	↔	⊕	📦	📊	🏷️
0983 0004	105 mm	M16	1	37,69	✓
0983 0005	220 mm	M16	1	50,47	✓
0983 0006	370 mm	M16	1	59,98	✓

BROCA DE CENTRAR / FORET DE CENTRAGE / CENTERING DRILL BIT / PUNTA DI CENTRAGGIO / BROCA DE CENTRAR



Ref	∅	📦	📊
0983 0007	8 mm	1	8,02

CORONAS DIAMANTE / FORET DE DIAMANT / DIAMOND CORE DRILL / FORETTI DIAMANTATI / SERRA CRANEANA DIAMANTE



Ref	∅	↔	⊕	⊕	📦	📊
1019 0032	32 mm	450 mm	9 mm	1"1/4	1	117,60
1019 0042	42 mm	450 mm	9 mm	1"1/4	1	127,68
1019 0052	52 mm	450 mm	9 mm	1"1/4	1	174,72
1019 0062	62 mm	450 mm	9 mm	1"1/4	1	204,96
1019 0072	72 mm	450 mm	9 mm	1"1/4	1	218,40
1019 0082	82 mm	450 mm	9 mm	1"1/4	1	248,64
1019 0092	92 mm	450 mm	9 mm	1"1/4	1	265,44
1019 0102	102 mm	450 mm	9 mm	1"1/4	1	305,76
1019 0112	112 mm	450 mm	9 mm	1"1/4	1	342,72
1019 0122	122 mm	450 mm	9 mm	1"1/4	1	349,44
1019 0127	127 mm	450 mm	9 mm	1"1/4	1	366,24
1019 0132	132 mm	450 mm	9 mm	1"1/4	1	366,24
1019 0142	142 mm	450 mm	9 mm	1"1/4	1	394,80
1019 0152	152 mm	450 mm	9 mm	1"1/4	1	423,12
1019 0162	162 mm	450 mm	9 mm	1"1/4	1	520,80
1019 0172	172 mm	450 mm	9 mm	1"1/4	1	548,52
1019 0177	177 mm	450 mm	9 mm	1"1/4	1	560,88
1019 0182	182 mm	450 mm	9 mm	1"1/4	1	561,60
1019 0200	200 mm	450 mm	9 mm	1"1/4	1	730,80
1019 0225	225 mm	450 mm	9 mm	1"1/4	1	814,32
1019 0250	250 mm	450 mm	9 mm	1"1/4	1	994,56
1019 0300	300 mm	450 mm	9 mm	1"1/4	1	1135,68



CORONAS PARA CONSTRUCCIÓN SISTEMA SDS MAX / SCIE CLOCHE (BATIMENT) SDS MAX / CONSTRUCTION LIGHT HOLLOW CORE BIT SDS MAX  
CORONE DA COSTRUZIONI SDS MAX / SERRA CRANEANA PARA CONSTRUÇÃO SISTEMA SDS MAX



ES CARACTERÍSTICAS TÉCNICAS. Corona perforadora de dos piezas con unión especial roscada. Dientes de metal duro. Largo de cuerpo: 80 mm. Largo útil: 70 mm. Broca de centrado incorporada. Adaptador SDS MAX.

FR CARACTERISTIQUES TECHIQUES: Couronne perforée de deux pièces avec union spéciale filetée. Dents de métal dur. Foret de centrage incorporé. Adaptateur SDS MAX.

EN TECHNICAL FEATURES: Two pieces tool with threaded joint. Hard metal teeth. Body length: 80mm. Useful length: 70mm. Centering drill bit. Adapter SDS MAX.

IT CARATTERISTICHE TECNICHE: Corona di perforazione in due pezzi con unione speciale filettata. Dentatura in metallo duro. Lunghezza corpo: 80mm; lunghezza utile 70mm. Punta di centraggio incorporata. Adattatore SDS MAX.

PT CARACTERÍSTICAS TÉCNICAS. Serra perfuradora de duas peças com união especial de rosca. Dentes de metal duro. Comprimento total: 80 mm. Comprimento útil: 70 mm. Broca centradora incorporada. Adaptador SDS MAX.

Ref	Ø	↔	📦	📊	🛒
0988 0045	45 mm	80 mm	1	134,73	✓
0988 0050	50 mm	80 mm	1	157,93	✓
0988 0055	55 mm	80 mm	1	175,70	✓
0988 0068	68 mm	80 mm	1	187,43	✓
0988 0082	82 mm	80 mm	1	260,20	✓
0988 0090	90 mm	80 mm	1	310,42	✓
0988 0100	100 mm	80 mm	1	330,17	✓
0988 0125	125 mm	80 mm	1	380,68	✓
0988 0150	150 mm	80 mm	1	497,85	✓

MANGO PORTACORONAS PARA TALADROS ANCLAJE SDS MAX / MANCHE POUR PERCEUSE SDS MAX / SDS MAX SHANK  
MANICO PER MARTELLI CON AGGANCIO SDS MAX / ADAPTADOR SDS-MAXO



Ref	↔	🔧	📦	📊	🛒
0988 0001	200 mm	SDS MAX	1	82,17	✓
0988 0002	460 mm	SDS MAX	1	96,82	✓

BROCA DE CENTRAR / FORET DE CENTRAGE / CENTERING DRILL BIT / PUNTA DI CENTRAGGIO / BROCA DE CENTRAR



Ref	Ø	↔	📦	📊	🛒
0988 0003	11 mm	135 mm	1	17,19	✓

CORONA DIAMANTE PARA USO CON AMOLADORA / COURONNE DIAMANT POUR USAGE MEULEUSE  
DIAMOND HOLE SAW FOR USE WITH CIRCULAR SAW / FRESA A TAZZA DIAMANTATA / COROA C/ DIAMANTE PARA USO COM REBARBADORAS



Ref	Ø	📦	📊	🛒
1019 2006	6 mm	1	49,40	✓
1019 2008	8 mm	1	53,05	✓
1019 2010	10 mm	1	56,20	✓
1019 2012	12 mm	1	65,30	✓
1019 2022	22 mm	1	84,05	✓
1019 2027	27 mm	1	93,50	✓
1019 2035	35 mm	1	105,78	✓
1019 2040	40 mm	1	125,05	✓
1019 2050	50 mm	1	150,90	✓
1019 2060	60 mm	1	159,90	✓
1019 2065	65 mm	1	166,05	✓
1019 2070	70 mm	1	180,40	✓
1019 2075	75 mm	1	192,70	✓

ES Corona de Diamante para uso con Radial. Coronas para granito, porcelánicas muy duros y suelos técnicos con rosca M14 (amoladoras).

FR Couronne diamant pour usage meuleuse. Couronnes pour granit, céramiques très dures et sols techniques, filetage M14 (Meuleuse d'angle).

EN Diamond hole saw for use with circular saw. Hole saws for granite, very hard porcelain materials and technical flooring with M14 thread (grinders).

IT Fresa a tazza diamantata. Frese per granito, porcellanato molto duro e pavimenti tecnici con filettatura M14 (smerigliatrici).

PT Coroa com diamante para uso com rebarbadoras. Coroa para granito, porcelana e pisos técnicos muito duros com rosca M14 (rebarbadoras).

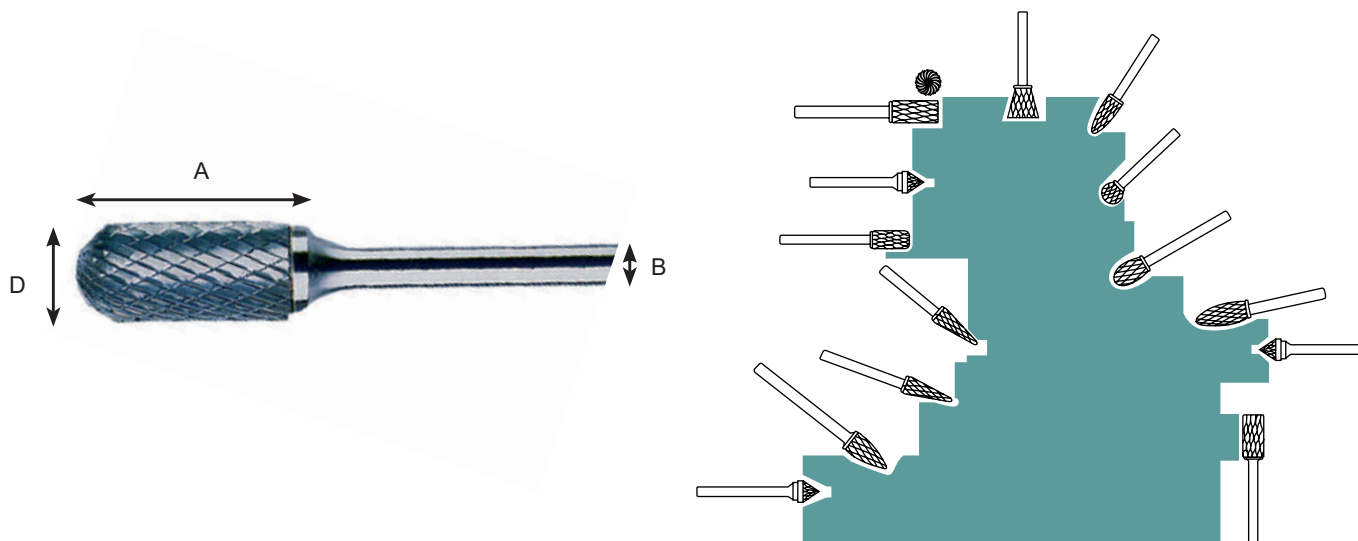

FRESAS ROTATIVAS METAL DURO "DENTADO CRUZADO" / FRAISES ROTATIVES MÉTAL DUR "DENTELLE CROIX"  
STRAIGHT SHANK ROTARY BURR "STAGGERED" / FRESE ROTATIVE IN METALLO DURO A DENTATURA DIAGONALE  
FRESAS ROTATIVAS METAL DURO "CORTE CRUZADO"

Cilíndrica con radio / Cylindrique rayon / Ball nosed point  
Cilíndrica, estremità sferica / Cilíndrico com raio



Ref	↔	A	B	D		
<b>3203 0303</b>	38 mm	13 mm	3 mm	3 mm	1	<b>14,05</b>
<b>3203 0603</b>	50 mm	13 mm	3 mm	6 mm	1	<b>22,91</b>
<b>3203 0606</b>	50 mm	19 mm	6 mm	6 mm	1	<b>27,75</b>
<b>3203 0806</b>	65 mm	19 mm	6 mm	8 mm	1	<b>32,78</b>
<b>3203 1006</b>	65 mm	19 mm	6 mm	10 mm	1	<b>36,41</b>
<b>3203 1206L</b>	70 mm	25 mm	6 mm	12 mm	1	<b>55,53</b>
<b>3203 1606</b>	70 mm	25 mm	6 mm	16 mm	1	<b>69,05</b>

Serie extralarga / Serie extra longue / Long series  
Lunghezza superiore / Série longa

Ref	↔	A	B	D		
<b>3216 1006</b>	150 mm	19 mm	6 mm	10 mm	1	<b>53,68</b>
<b>3216 1206</b>	150 mm	25 mm	6 mm	12 mm	1	<b>71,33</b>

Punta esférica / Cylindrique spherique / Ball point  
Estremità sferica / Ponta esférica



Ref	↔	A	B	D		
<b>3204 0303</b>	38 mm	2,7 mm	3 mm	3 mm	1	<b>14,30</b>
<b>3204 0603</b>	38 mm	5,4 mm	3 mm	6 mm	1	<b>21,55</b>
<b>3204 0606</b>	50 mm	5,4 mm	6 mm	6 mm	1	<b>25,41</b>
<b>3204 0806</b>	52 mm	7,2 mm	6 mm	8 mm	1	<b>28,19</b>
<b>3204 1006</b>	53 mm	9,0 mm	6 mm	10 mm	1	<b>28,92</b>
<b>3204 1206</b>	55 mm	10,8 mm	6 mm	12 mm	1	<b>38,98</b>
<b>3204 1606</b>	60 mm	14,4 mm	6 mm	16 mm	1	<b>52,69</b>
<b>3204 1906</b>	63 mm	17,1 mm	6 mm	19 mm	1	<b>70,02</b>

Serie extralarga / Serie extra longue / Long series  
Lunghezza superiore / Série longa

Ref	↔	A	B	D		
<b>3218 1206</b>	150 mm	10,8 mm	6 mm	12 mm	1	<b>55,96</b>

**FRESAS ROTATIVAS METAL DURO "DENTADO CRUZADO" / FRAISES ROTATIVES MÉTAL DUR "DENTELLE CROIX"**  
**STRAIGHT SHANK ROTARY BURR "STAGGERED" / FRESE ROTATIVE IN METALLO DURO A DENTATURA DIAGONALE**  
**FRESAS ROTATIVAS METAL DURO "CORTE CRUZADO"**

Cilíndrica sin corte centro / Cylindrique sans coupe centrale  
 Point without center cutting / Cilíndrica senza taglio centrale  
 Cilíndrico sem corte central

Ref	↔	A	B	D		
<b>3201 0303</b>	38 mm	13 mm	3 mm	3 mm	1	<b>12,57</b>
<b>3201 0404</b>	50 mm	13 mm	4 mm	4 mm	1	<b>20,95</b>
<b>3201 0606</b>	50 mm	19 mm	6 mm	6 mm	1	<b>24,59</b>
<b>3201 0806</b>	65 mm	19 mm	6 mm	8 mm	1	<b>30,84</b>
<b>3201 1006</b>	65 mm	19 mm	6 mm	10 mm	1	<b>34,48</b>
<b>3201 1206L</b>	70 mm	25 mm	6 mm	12 mm	1	<b>49,44</b>
<b>3201 1606</b>	70 mm	25 mm	6 mm	16 mm	1	<b>62,17</b>

Serie extralarga / Serie extra longue / Long series  
 Lunghezza superiore / Série longa

Ref	↔	A	B	D		
<b>3214 1006</b>	150 mm	19 mm	6 mm	10 mm	1	<b>45,41</b>



Cilíndrica con corte centro / Cylindrique avec coupe centrale  
 Center cutting point / Cilíndrica con taglio centrale  
 Cilíndrico com corte central

Ref	↔	A	B	D		
<b>3202 0303</b>	38 mm	13 mm	3 mm	3 mm	1	<b>13,63</b>
<b>3202 0404</b>	50 mm	13 mm	4 mm	4 mm	1	<b>25,02</b>
<b>3202 0606</b>	50 mm	19 mm	6 mm	6 mm	1	<b>27,20</b>
<b>3202 0806</b>	65 mm	19 mm	6 mm	8 mm	1	<b>34,48</b>
<b>3202 1006</b>	65 mm	19 mm	6 mm	10 mm	1	<b>37,96</b>
<b>3202 1206L</b>	70 mm	25 mm	6 mm	12 mm	1	<b>54,54</b>
<b>3202 1606</b>	70 mm	25 mm	6 mm	16 mm	1	<b>72,71</b>

Serie extralarga / Serie extra longue / Long series  
 Lunghezza superiore / Série longa

Ref	↔	A	B	D		
<b>3215 0303</b>	63 mm	13 mm	3 mm	3 mm	1	<b>22,15</b>
<b>3215 0606</b>	75 mm	19 mm	6 mm	6 mm	1	<b>39,12</b>



Árbol con radio "punta redondeada" / Embout arrondie  
 Ball nosed tree point / Punta arrotondata / Ponta arredondada

Ref	↔	A	B	D		
<b>3206 0603</b>	45 mm	13 mm	3 mm	6 mm	1	<b>22,76</b>
<b>3206 1006</b>	65 mm	19 mm	6 mm	10 mm	1	<b>40,44</b>
<b>3206 1206</b>	70 mm	25 mm	6 mm	12 mm	1	<b>53,67</b>
<b>3206 1606</b>	70 mm	25 mm	6 mm	16 mm	1	<b>70,34</b>

Serie extralarga / Serie extra longue / Long series  
 Lunghezza superiore / Série longa

Ref	↔	A	B	D		
<b>3219 1206</b>	150 mm	25 mm	6 mm	12 mm	1	<b>70,52</b>



FRESAS ROTATIVAS METAL DURO "DENTADO CRUZADO" / FRAISES ROTATIVES MÉTAL DUR "DENTELLE CROIX"  
STRAIGHT SHANK ROTARY BURR "STAGGERED" / FRESE ROTATIVE IN METALLO DURO A DENTATURA DIAGONALE  
FRESAS ROTATIVAS METAL DURO "CORTE CRUZADO"



Árbol punta ojiva / Embout arbre ojive / Tree point  
Punta a ogiva / Pontiaguda

Ref	↔	A	B	D		
<b>3207 0303</b>	38 mm	13 mm	3 mm	3 mm	1	<b>16,28</b>
<b>3207 0603</b>	45 mm	13 mm	3 mm	6 mm	1	<b>23,56</b>
<b>3207 0606</b>	50 mm	16 mm	6 mm	6 mm	1	<b>29,05</b>
<b>3207 1006</b>	65 mm	19 mm	6 mm	10 mm	1	<b>39,12</b>
<b>3207 1206L</b>	70 mm	25 mm	6 mm	12 mm	1	<b>50,04</b>
<b>3207 1606</b>	70 mm	25 mm	6 mm	16 mm	1	<b>70,59</b>

Serie extralarga / Serie extra longue / Long series  
Lunghezza superiore / Série longa

Ref	↔	A	B	D		
<b>3217 1206</b>	150 mm	25 mm	6 mm	12 mm	1	<b>70,90</b>



Punta llama / Embout flame / Flame point / Punta a fiamma / Ponta de chama

Ref	↔	A	B	D		
<b>3208 0303</b>	38 mm	8 mm	3 mm	3 mm	1	<b>18,20</b>
<b>3208 0606</b>	50 mm	14 mm	6 mm	6 mm	1	<b>30,94</b>
<b>3208 0806</b>	65 mm	19 mm	6 mm	8 mm	1	<b>35,52</b>
<b>3208 1206</b>	77 mm	32 mm	6 mm	12 mm	1	<b>71,89</b>



Punta cónica / Embout conique / Cone point / Punta conica Ponta cônica

Ref	↔	A	B	D		
<b>3209 0303</b>	38 mm	11 mm	3 mm	3 mm	1	<b>16,28</b>
<b>3209 0606</b>	50 mm	19 mm	6 mm	6 mm	1	<b>26,40</b>
<b>3209 1006</b>	65 mm	16 mm	6 mm	10 mm	1	<b>35,52</b>
<b>3209 1206L</b>	70 mm	22 mm	6 mm	12 mm	1	<b>50,04</b>



Punta cónica 90° / Embout conique 90° / 90° cone point Punta conica 90° / Ponta cônica 90°

Ref	↔	A	B	D		
<b>3210 1006</b>	55 mm	5 mm	6 mm	10 mm	1	<b>31,45</b>
<b>3210 1606</b>	60 mm	8 mm	6 mm	16 mm	1	<b>50,90</b>





FRESAS ROTATIVAS METAL DURO "DENTADO CRUZADO" / FRAISES ROTATIVES MÉTAL DUR "DENTELLE CROIX"  
STRAIGHT SHANK ROTARY BURR "STAGGERED" / FRESE ROTATIVE IN METALLO DURO A DENTATURA DIAGONALE  
FRESAS ROTATIVAS METAL DURO "CORTE CRUZADO"



Punta cónica con radio / Embout conique rayon / Cone point / Punta conica sferica / Ponta cônica com raio

Ref	↔	A	B	D		
3211 0303	38 mm	8 mm	3 mm	3 mm	1	17,83
3211 0603	45 mm	13 mm	3 mm	6 mm	1	29,32
3211 0606	50 mm	16 mm	6 mm	6 mm	1	30,59
3211 1006L	75 mm	27 mm	6 mm	10 mm	1	45,41
3211 1206	75 mm	30 mm	6 mm	12 mm	1	53,76
3211 1606	78 mm	33 mm	6 mm	16 mm	1	130,79



Punta forma gota "oval" / Embout ovale / Oval point / Punta ovale / Ponta Oval

Ref	↔	A	B	D		
3205 0303	38 mm	6 mm	3 mm	3 mm	1	15,47
3205 0603	42 mm	10 mm	3 mm	6 mm	1	22,29
3205 0806	58 mm	13 mm	6 mm	8 mm	1	30,84
3205 1006	60 mm	16 mm	6 mm	10 mm	1	35,18
3205 1206	67 mm	22 mm	6 mm	12 mm	1	47,22
3205 1606	70 mm	25 mm	6 mm	16 mm	1	76,58



Cónica invertida sin dentado frontal / Conique inversee sans denture frontale / Inverted cone point without gear teeth  
Punta cónica invertita, senza dentatura frontale / Cônica invertida sem dentado frontal

Ref	↔	A	B	D		
3212 0303	38 mm	7 mm	3 mm	3 mm	1	19,11
3212 0606	50 mm	7 mm	6 mm	6 mm	1	27,68

TABLA DE VELOCIDADES RECOMENDADAS / TABLEAU DE VITESSES RECOMMANDEES / TABLE OF RECOMMENDED SPEED  
TAVOLA DELLE VELOCITA' RACCOMANDANTE / TABELA DE VELOCIDADES RECOMENDADAS



CRUZADO RPM: VELOCIDAD DE CORTE x 1000  
CROISEMENT RPM: VITESSE DE COUPE x 1000  
CROSSED RPM: CUT SPEED x 1000  
RPM: VELOCITÀ DI TAGLIO x 1000  
CRUZADO RPM: VELOCIDADE DE CORTE x 1000

MODEL	
4 mm	30
6 mm	30
8 mm	30
10 mm	25
12 mm	20
16 mm	18
20 mm	15
25 mm	15



JUEGO 10 FRESAS ROTATIVAS / KIT 10 FRAISES ROTATIVES / MILLS CASE WITH 10 PCS / SET DI 10 FRESE ROTATIVE / JOGO 10 FRESAS ROTATIVAS

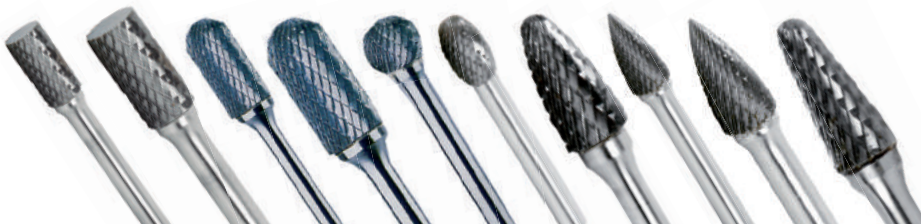

Contenido / Contenu / Contents / Contenuto / Conteúdo

Ref	↔	A	B	D
<b>3201 1006</b>	65 mm	19 mm	6 mm	10 mm
<b>3201 1206</b>	70 mm	25 mm	6 mm	12 mm
<b>3203 1006</b>	65 mm	19 mm	6 mm	10 mm
<b>3203 1206</b>	70 mm	25 mm	6 mm	12 mm
<b>3204 1006</b>	53 mm	9 mm	6 mm	10 mm
<b>3205 1006</b>	60 mm	16 mm	6 mm	10 mm
<b>3206 1206</b>	70 mm	25 mm	6 mm	12 mm
<b>3207 1006</b>	65 mm	19 mm	6 mm	10 mm
<b>3207 1206</b>	70 mm	25 mm	6 mm	12 mm
<b>3211 1206</b>	75 mm	30 mm	6 mm	12 mm

Ref	↓	📦	📊
<b>3220 0111</b>	10 pcs	1	<b>417,75</b>

JUEGO 5 FRESAS ROTATIVAS / KIT 5 FRAISES ROTATIVES / MILLS CASE WITH 5 PCS / SET DI 5 FRESE ROTATIVE / JOGO 5 FRESAS ROTATIVAS



Contenido / Contenu / Contents / Contenuto / Conteúdo

Ref	↔	A	B	D
<b>3201 1206</b>	70 mm	25 mm	6 mm	12 mm
<b>3203 1206</b>	70 mm	25 mm	6 mm	12 mm
<b>3207 1206</b>	70 mm	25 mm	6 mm	12 mm
<b>3211 1206</b>	75 mm	30 mm	6 mm	12 mm
<b>3206 1206</b>	75 mm	30 mm	6 mm	12 mm

Ref	↓	📦	📊
<b>3221 0111</b>	5 pcs	1	<b>252,60</b>



CEPILLO BROCHA TRENZADO ACERO 0.5 MM / BROSE TRESSEE ACIER 0.5 MM / TWIST KNOT END BRUSH STEEL 0.5 MM  
 SPAZZOLA A PENNELLO INTRECCIATA ACCIAIO 0.5 MM / ESCOVA PINCEL TRANÇADA AÇO 0.5 MM



Ref		rpm	Ø		
1025 0001	6 mm	20.000	22 mm	1	4,49

CEPILLO CIRCULAR TRENZADO ACERO 0,5 MM / BROSE CIRCULAIRE TRESSEE ACIER 0,5 MM / SHAFT MOUNTED CIRCULAR BRUSH STEEL 0.5 MM  
 SPAZZOLA A DISCO INTRECCIATA ACCIAIO 0,5 MM / ESCOVA CIRCULAR TRANÇADA AÇO 0,5 MM



Ref		rpm	Ø		
1025 0005	6 mm	15.000	75 mm	1	4,35

CEPILLO COPA ONDULADO A.LATONADO 0.3 MM / BROSE FIL ONDULÉ A.LAITON 0.3 MM / CRIMPED CUP WIRE BRUSH BRASS-PLATED STEEL 0.3 MM  
 SPAZZOLA A TAZZA ONDULATA ACCIAIO OTTONATO 0.3 MM / ESCOVA COPO ONDULADO A.LATÃO 0.3 MM



Ref		rpm	Ø		
1025 0010	6 mm	4.500	50 mm	1	2,52
1025 0011	6 mm	4.500	75 mm	1	3,21
1025 0012	6 mm	4.500	100 mm	1	5,73

CEPILLO BROCHA ONDULADO A.LATONADO 0.3 MM / BROSE ONDULEE A.LAITON 0.3 MM / CRIMPED END WIRE BRUSH BRASS-PLATED STEEL 0.3 MM  
 SPAZZOLA A PENNELLO INTRECCIATA ACCIAIO OTTONATO 0.3 MM / ESCOVA PINCEL ONDULADO A.LATÃO 0.3 MM



Ref		rpm	Ø		
1025 0021	6 mm	4.500	15 mm	1	2,46
1025 0022	6 mm	4.500	25 mm	1	3,21

CEPILLO CIRCULAR ONDULADO A.LATONADO 0.3 MM / BROSE CIRCULAIRE ONDULEE A.LAITON 0.3 MM  
 CRIMPED WIRE WHEEL BRASS-PLATED STEEL 0.3 MM / SPAZZOLA A DISCO INTRECCIATA ACCIAIO OTTONATO 0.3 MM  
 ESCOVA CIRCULAR ONDULADA A.LATÃO 0.3 MM



Ref		rpm	Ø		
1025 0031	6 mm	4.500	38 mm	1	1,78
1025 0032	6 mm	4.500	50 mm	1	1,87
1025 0033	6 mm	4.500	75 mm	1	2,23
1025 0034	6 mm	4.500	100 mm	1	2,91



CEPILLO OBLICUO TRENZADO ACERO 0.5 MM / BROSE OBLIQUE TRESSEE ACIER 0.5 MM / TWIST KNOT BEVEL BRUSH STEEL 0.5 MM  
 SPAZZOLA OBLIQUA INTRECCIATA ACCIAIO 0.5 MM / ESCOVA OBLÍQUO TRANÇADA AÇO 0.5 MM



Ref	M	rpm	∅		
1025 0041	14	12.500	100 mm	1	5,82

CEPILLO COPA ONDULADO ACERO 0.3 MM / BROSE FIL ONDULÉ ACIER 0.3 MM / CRIMPED CUP WIRE BRUSH STEEL 0.3 MM  
 SPAZZOLA A TAZZA ONDULATA ACCIAIO 0.3 MM / ESCOVA COPO ONDULADA AÇO 0.3 MM



Ref	M	rpm	∅		
1025 0061	14	12.500	65 mm	1	4,24
1025 0062	14	12.500	85 mm	1	5,08
1025 0063	14	8.500	100 mm	1	6,81
1025 0064	14	6.500	125 mm	1	12,29

CEPILLO COPA TRENZADO ACERO 0.5 MM / BROSE TRESSEE ACIER 0.5 MM / TWIST KNOT WIRE CUP BRUSH STEEL 0.5 MM  
 SPAZZOLA A TAZZA INTRECCIATA ACCIAIO 0.5 MM / ESCOVA COPO TRANÇADA AÇO 0.5 MM



Ref	M	rpm	∅		
1025 0071	14	12.500	75 mm	1	5,57
1025 0072	14	8.500	100 mm	1	9,08
1025 0073	14	6.500	125 mm	1	12,78

CEPILLO COPA ONDULADO A.LATONADO 0.3 MM / BROSE FIL ONDULÉ A.LAITON 0.3 MM / CRIMPED CUP WIRE BRUSH BRASS-PLATED STEEL 0.3 MM  
 SPAZZOLA A TAZZA ONDULATA ACCIAIO OTTONATO 0.3 MM / ESCOVA COPO ONDULADA A.LATÃO 0.3 MM



Ref	M	rpm	∅		
1025 0051	14	12.500	65 mm	1	4,24
1025 0052	14	12.500	85 mm	1	5,09
1025 0053	14	8.500	100 mm	1	6,81
1025 0054	14	6.500	125 mm	1	12,29

CEPILLO OBLICUO ONDULADO A.LATÓN 0.3 MM / BROSE OBLIQUE ONDULEE A.LATON 0.3 MM / CRIMPED WIRE BEVEL BRUSH BRASS-PLATED STEEL 0.3 MM  
 SPAZZOLA OBLIQUA INTRECCIATA ACCIAIO OTTONATO 0.3 MM / ESCOVA OBLÍQUO ONDULADA A.LATÃO 0.3 MM



Ref	M	rpm	∅		
1025 0081	14	12.500	100 mm	1	5,23
1025 0082	14	12.500	125 mm	1	7,18

RUEDA ALAMBRE ONDULADO A.LATÓN 0.3 MM / ROUE FIL ONDULEE A.LATON 0.3 MM / CRIMPED WIRE WHEEL BRASS-PLATED STEEL 0.3 MM  
 SPAZZOLA A DISCO ONDULATA ACCIAIO OTTONATO 0.3 MM / RODA ARAME ONDULADA A.LATÃO 0.3 MM



Ref	EJE	rpm	∅		
1025 0093	20	6.000	125 mm	1	7,11
1025 0095	32	6.000	150 mm	1	12,29
1025 0097	32	6.000	180 mm	1	11,20
1025 0099	32	3.000	250 mm	1	25,47







	ES	FR	EN	IT	PT
<b>Ref</b>	Referencia	Référence	Reference	Riferimento	Referência
	Grosor, espesor	Grosueur, épaisseur	Thickness	Spessore o larghezza	Grossura, espessura
	Diámetro	Diamètre	Diameter	Diametro	Diâmetro
	Disco abombado	Disque bombé	Convex disc	Disco convesso	Disco convexo
	Disco plano	Disque plat	Flat disc	Disco piatto	Disco plano
	Unidad mínima de venta	Nombre d'unités minimum de vente	Minimum sale unit	Quantitativo minimo di vendita	Unidade mínima de venda
	Packing	Conditionnement	Packing	Imballo	Embalagem
	Precio	Prix	Price	Prezzo	Preço
	Agujero o eje	Trou ou axe	Hole or Axle	Foro o Asse	Buraco ou eixo
	Medidas	Mesures	Measurements	Misure	Medidas
<b>MODEL</b>	Modelo	Modèle	Model	Modello	Modelo
	Segmento	Segment	Segment	Segmento	Segmento
	Blister	Blister	Blister	Blister	Blister
	Descripción	Description	Description	Descrizione	Descrição
	Grano	Grain	Particle /Grain	Grão	Grano
	Longitud	Longueur	Length	Lunghezza	Comprimento
	Conexión	Connexion	Connection	Connessione	Conexão
<b>P</b>	Paso	Pas	Pitch	Passo	Passo
	Morse exterior	Morse extérieur	Cono Morse exterior	Morse esterno	Cone Morse exterior
<b>HSS</b>	HSS unidades	HSS HSS unités	HSS units	Unità HSS	HSS unidades
<b>HSS-CO</b>	Cobalto unidades	CO Cobalt unités	Cobalt units	Unità Cobalto	Cobalto unidades
<b>HSS-TIN</b>	Titanio unidades	Toi Titane unités	Titanium units	Unità Titanio	Titânio unidades
	Contenido	Contenu	Contents	Contenuto	Conteúdo
	Ancho Hex	Largeur Hex	Hex width	Larghezza es.	Largura Hex
	Ancho filo	Largeur fil	Point width	Larghezza bordo	Largura ponta
	Rosca	Filetage	Thread	Rivettatura	Rosca entrada de ar PT
	Alcance del portabrocas	Portée du porte-mèche	Scope of the drill chuck	Distância do mandril	Lunghezza punta
<b>M x P</b>	Métrica por paso	Mètres x pas	Metric X thread	Metro x passo	Métrica por passo
<b>M</b>	Métrica	Mètres	Metric	Metro	Métrica
<b>NUMBER</b>	Número	Nombre	Number	Número	Numero
<b>BOSCH</b>	Adaptable o "BOSCH"	Adaptable ou "BOSCH"	Adaptable o "Bosch"	Adaptável ou "BOSCH"	Adattabile o "BOSCH"
<b>QUALITY</b>	Calidad	Qualité	Quality	Qualidade	Qualità
	Número de dientes	Nombre de dents	Teeth number	Numero denti	Número de dentes
<b>rpm</b>	Revoluciones por minuto	Rotations par minute	Revolutions per minute	Giri per minuto	Rotações por minuto
<b>EJE</b>	Eje	Axe	Axis	Asse	Eixo





 cofan





# ÍNDICE / INDEX / CONTENTS

## INDICE / ÍNDICE



**524**

TACOS DE FIJACIÓN DE NYLON  
CHEVILLES DE FIXATION NYLON  
NYLON FIXING PLUGS  
TASSELLI FISSAGGIO NYLON  
BUCHAS DE FIXAÇÃO EM NYLON



**538**

REMACHADORAS / RIVETEUSE / RIVETING  
RIVETTATRICE / REBITES



**528**

TACO AUTOPERFORANTE  
CHEVILLES AUTOPERCEUSE  
SELF DRILLING PLUG  
TASELLI AUTOFORANTI  
BUCHA AUTO PERFURAÇÃO



**540**

REMACHES / RIVETS / RIVETS  
RIVETTO / REBITES



**529**

TACO RÁPIDO GOLPE / CHEVILLES RAPIDES  
FIXING-PLUG / TASSELLO RAPIDO  
BUCHA GOLPE RÁPIDO



**548**

TUERCAS REMACHABLES / ECROUS À RIVER  
RIVET NUTS / DADO A RIVETTO / PORCAS DE CRAVAR



**531**

ANCLAJE METÁLICO / CHEVILLES EN ACIER  
STEEL BOLTS / TASSELLO METALLICO  
BUCHA METÁLICA



**550**

BRIDAS DE NYLON / COLLIERS / CABLE TIES  
FASCETTE / ABRAÇADEIRAS AJUSTÁVEIS



**537**

ANCLAJE QUÍMICO/ RESINE CHIMIQUE  
CHEMICAL ANCHOR / ANCORANTE CHIMICO  
FIXAÇÃO QUÍMICO



**552**

ABRAZADERAS / COLLIERS / HOSE CLAMPS  
FASCETTE / ABRAÇADEIRAS





**557**

TIRAFONDOS / TIRE-FONDS / LAG SCREWS  
TIRAFONDI / PARAFUSOS

**i**

**568**

GLOSARIO / GLASSAIRE / GLOSSARY  
GLOSSARIO / GLOSSÁRIO



**558**

ANILLOS SEEGER / ANNEAUX SEEGER / SEEGER RINGS  
ANELLO SEEGER / ANEIS SEEGER



**561**

PASADORES ELÁSTICOS / GOUPILLES / SPLIT PIN  
SPINE ELASTICHE / CAVILHAS ELÁSTICAS



**562**

PASADORES DE ALETA / GOUPILLES / SPLIT PINS  
SPINE A COPPIGLIA / GOLPILHAS



**563**

PASADORES / GOUPILLES / SPLIT PINS  
SPINE ELASTICHE / CAVILHAS



**564**

JUNTAS TÓRICAS / JOINTS TORIQUES / O-RINGS  
GIUNTI TORICI / ANÉIS DE RETENÇÃO

TACO PLÁSTICO BLANCO ESTÁNDAR / CHEVILLE PLASTIQUE BLANCHE STANDARD / WHITE PLASTIC FIXING PLUG  
TASSELLO BIANCO IN PLASTICA / BUCHA PLÁSTICA BRANCA STANDARD



Precio x bolsa / Price x bag

Ref	Ø	↓	⬆	⬇	Ref	Ø	↓	⬆	⬇
0760 2105	5 mm	25	40	0,46	0760 2005	5 mm	100	1	1,77
0760 2106	6 mm	25	40	0,49	0760 2006	6 mm	100	1	1,87
0760 2108	8 mm	25	40	0,77	0760 2008	8 mm	100	1	3,02
0760 2110	10 mm	25	10	1,32	0760 2010	10 mm	100	1	5,20
0760 2112	12 mm	25	10	2,31	0760 2012	12 mm	100	1	9,15

TACO NYLON ALADO SIN COLLARÍN / CHEVILLE PLASTIQUE A AILETTE SANS BORDURE / FIXING PLUG WITHOUT COLLAR  
TASSELLO IN NYLON SENZA TESTA / BUCHA DE NYLON COM ALAS SEM BORDA



ES Taco de nylon por expansión. Tacos con aletas laterales para evitar el giro.  
FR Cheville plastique à expansion. Cheville à ailette latérale pour éviter la rotation.  
EN Nylon fixing expansion plug. Plugs with lateral wings to avoid turning.  
IT Tassello fissaggio ad espansione. Tasselli con ali laterali per impedirne la rotazione.  
PT Bucha de expansão e fixação em nylon. Buchas com asas laterais para evitar rotação.

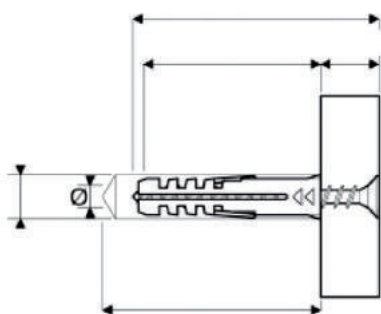

Precio x 100 unidades / Price x 100 units

Ref	Ø	⬆	⬇	⊙	⬆	⬇
0760 1004	4 mm	20 mm	25 mm	2 - 3 mm	200	2,18
0760 1006	6 mm	30 mm	40 mm	4 - 5 mm	100	2,70
0760 1008	8 mm	40 mm	55 mm	4,5 - 6 mm	100	3,85
0760 1010	10 mm	50 mm	70 mm	6 - 8 mm	50	6,55
0760 1012	12 mm	60 mm	80 mm	8 - 10 mm	25	12,58
0760 1014	14 mm	75 mm	95 mm	10 - 12 mm	20	19,76
0760 1016	16 mm	80 mm	100 mm	12 - 14 mm	20	40,56

TACO NYLON ALADO CON COLLARÍN / CHEVILLE PLASTIQUE A AILETTES AVEC BORDURE / NYLON WALL PLUG WITH FINNS AND COLLAR  
TASSELLO IN NYLON CON AILETTE E BORDINO / BUCHA DE NYLON COM ALAS COM GOLA



ES Taco de nylon por expansión. Tacos con aletas laterales para evitar el giro.  
FR Cheville plastique à expansion. Cheville à ailette latérale pour éviter la rotation.  
EN Nylon fixing expansion plug. Plugs with lateral wings to avoid turning.  
IT Tassello fissaggio ad espansione. Tasselli con ali laterali per impedirne la rotazione.  
PT Bucha de expansão e fixação em nylon. Buchas com asas laterais para evitar rotação.

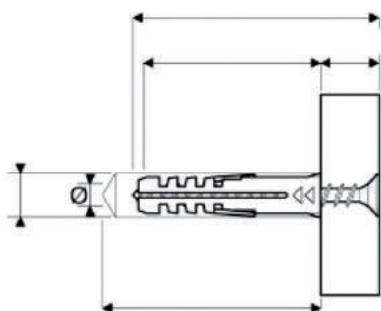

Precio x 100 unidades / Price x 100 units

Ref	Ø	⬆	⬇	⊙	⬆	⬇
0760 1104	4 mm	20 mm	25 mm	2 - 3 mm	200	2,18
0760 1106	6 mm	30 mm	40 mm	4 - 5 mm	100	2,70
0760 1108	8 mm	40 mm	55 mm	4,5 - 6 mm	100	3,85
0760 1110	10 mm	50 mm	70 mm	6 - 8 mm	50	6,55
0760 1112	12 mm	60 mm	80 mm	8 - 10 mm	25	12,58
0760 1114	14 mm	75 mm	95 mm	10 - 12 mm	20	19,76



TACOS DE FIJACIÓN DE NYLON / CHEVILLES DE FIXATION NYLON POUR EXPANSION / NYLON FIXING PLUGS  
TASSELLO FISSAGGIO / BUCHAS DE FIXAÇÃO EM NYLON



- ES Taco de nylon por expansión. Tacos con lengüetas laterales para evitar el giro.
- FR Chevilles de fixation nylon pour expansion. Chevilles avec languettes latérales pour éviter la rotation.
- EN Nylon fixing expansion plug. Plugs with lateral wings to avoid turning.
- IT Tassello fissaggio ad espansione. Tassello con linguette laterali per impedirne la rotazione.
- PT Bucha de nylon de expansão. Com aletas laterais anti-rotação.

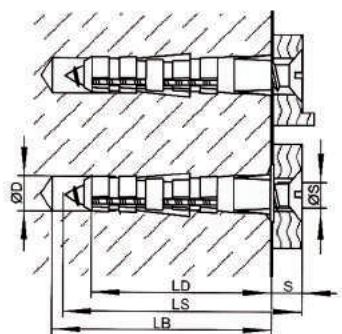

Precio x 100 unidades / Price x 100 units

Ref	Ø			Ø		
0760 0006	6 mm	30 mm	40 mm	3,5 - 5,0 mm	100	<b>1,98</b>
0760 0007	7 mm	35 mm	45 mm	4,0 - 5,5 mm	100	<b>2,07</b>
0760 0008	8 mm	40 mm	50 mm	4,5 - 6,0 mm	100	<b>3,39</b>
0760 0010	10 mm	50 mm	65 mm	6,0 - 8,0 mm	50	<b>5,57</b>
0760 0012	12 mm	60 mm	75 mm	8,0 - 10,0 mm	25	<b>10,09</b>
0760 0014	14 mm	70 mm	85 mm	10,0 - 12,0 mm	20	<b>15,34</b>

TACOS ANUDABLES DE GRAN EXPANSIÓN / CHEVILLES DE FIXATION POUR GRANDE EXPANSION / GREAT EXPANSION PLUGS  
TASSELLO IN NYLON AD ESPANSIONE / BUCHAS DE GRANDE EXPANSÃO



- ES Tacos anudables de gran expansión para la fijación sobre materiales macizos o huecos.
- FR Chevilles de fixation nylon pour expansion. Chevilles avec languettes latérales pour éviter la rotation.
- EN Great expansion plugs for fixing on solid or hollow materials. Ideal for wood and chipboard screws.
- IT Tassello in nylon. Tassello a grande espansione per fissaggio di materiali massicci o vuoti.
- PT Buchas de grande expansão para fixação em materiais sólidos ou ocós.

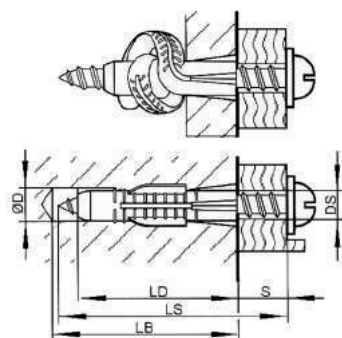

Precio x 100 unidades / Price x 100 units

Ref	Ø			Ø		
0761 0005	5 mm	32 mm	40 mm	3,0 - 4,0 mm	100	<b>2,30</b>
0761 0006	6 mm	37 mm	45 mm	4,0 - 5,0 mm	100	<b>2,52</b>
0761 0008	8 mm	52 mm	60 mm	5,0 - 6,0 mm	50	<b>4,57</b>
0761 0010	10 mm	62 mm	75 mm	7,0 - 8,0 mm	25	<b>8,42</b>
0761 0012	12 mm	72 mm	85 mm	8,0 - 10,0 mm	25	<b>11,30</b>
0761 0014	14 mm	76 mm	90 mm	10,0 - 12,0 mm	20	<b>14,68</b>

TACOS HUECOS PEQUEÑAS CARGAS MATERIALES / PETITES CHEVILLES POUR MATERIAUX CREUX / SMALL LOAD PLUGS FOR HOLLOW MATERIALS  
TASSELLO PER PICCOLI PESI SU MATERIALI VUOTI / BUCHAS PEQUENAS CARGAS PARA MATERIAS OCOS

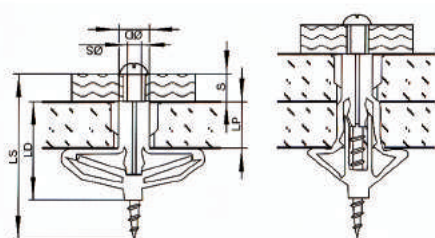

- ES Se recomienda el empleo de tornillos con rosca hasta la cabeza.
- FR Il est recommandé d'employer des vis avec filetage total.
- EN It is highly recommended to use screw with full thread.
- IT Si raccomanda l'utilizzo di viti a gambo totalmente filettate.
- PT É altamente recomendado o uso de parafusos com rosca completa.

Price x 100 units

Ref	Ø		M		
0769 0001	10 mm	50 mm	3,5-4,0mm	100	<b>11,91</b>

TACOS DE FIJACIÓN DE NYLON PA-6 / CHEVILLES DE FIXATION NYLON POUR EXPANSION PA-6 / NYLON FIXING PLUGS PA-6  
TASSELLO FISSAGGIO PA-6 / BUCHAS DE FIXAÇÃO EM NYLON PA-6



ES Tacos anudables de gran expansión para la fijación sobre materiales macizos o huecos.  
FR Chevilles de fixation nylon pour expansion. Chevilles avec languettes latérales pour éviter la rotation.  
EN Great expansion plugs for fixing on solid or hollow materials. Ideal for wood and chipboard screws.  
IT Tassello in nylon. Tassello a grande espansione per fissaggio di materiali massicci o vuoti.  
PT Buchas de grande expansão para fixação em materiais sólidos ou ocos.

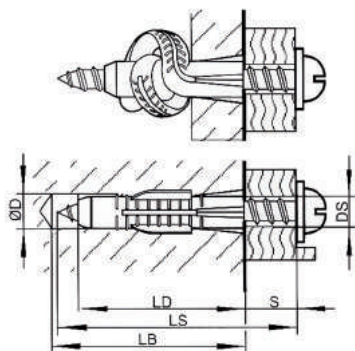

Precio x 100 unidades / Price x 100 units

Ref	Ø	Length	Box	Stack
0760 3001	5 mm	25 mm	200	2,76
0760 3002	6 mm	30 mm	100	3,06
0760 3003	8 mm	40 mm	100	5,42
0760 3004	10 mm	50 mm	50	8,95
0760 3005	10 mm	60 mm	50	11,14
0760 3006	12 mm	60 mm	25	14,50
0760 3007	14 mm	70 mm	20	23,19

TACO FLECHA PLACAS DE YESO-PA6 / CHEVILLE FLÈCHE PLAQUES DE PLATRE-PA6 / ARROW PLASTERBOARD-PA6 WALL PLUG  
TASSELLO PER CARTONGESSO-PA6 / BUCHA SETA PLACAS DE GESSO-PA6



ES Taco tipo flecha para paredes de pladur o cartón / yeso. Es ideal para fijaciones de cargas ligeras en paredes de cartón/ yeso, pladur o knauf. El taco se expande al insertar el tornillo y eso hace que las alas que tiene se apoyen sobre la pared, manteniendo una fijación firme y segura.  
FR Chevilles type flèche pour murs pladur ou carton/plâtre. Idéal pour fixations de charges légères sur murs et cloisons carton/plâtre, pladur ou knauf. La cheville se développe en insérant la vis, ce qui permet aux ailettes s'appuient sur la cloison en permettant une fixation ferme et sûre.  
EN Arrow Wall plug for plasterboard or cardboard/plaster walls. Ideal for fastening light loads into the cardboard / plaster, plasterboard or knauf walls. The wall plug expands by inserting the screw making the wings be held to the wall and so, keeping it fixed and safe.  
IT Tassello per pareti in cartongesso. Ideale per il fissaggio di carichi leggeri in pareti di cartongesso o Knauf. Il tassello "tipo freccia" si espande inserendo la vite allungando le alette presenti, rendendo il fissaggio nella parete stabile e sicuro.  
PT Bucha tipo seta para paredes de pladur ou catao/gesso. É ideal para fixações de cargas ligeiras em paredes de cartao/gesso, pladur ou Knauf. A bucha é expandida através da inserção do parafuso e que faz com que as asas que tem apoiem-se na parede mantendo uma fixação firme e segura.



Tornillo no incluido  
Screw not included

Precio x 100 unidades / Price x 100 units

Ref	Ø	Length	Medida Tornillo	Espesor Pared	Box	Stack
0769 0610	6 mm	34 mm	3,5x35	9-13 mm	100	7,36
0769 0617	6 mm	38 mm	3,5x40	13-20 mm	100	7,81

TACO PLADUR CON ALAS-PA6 / CHEVILLES PLADUR AVEC AILETTES-PA6 / WINGS PLASTERBOARD-PA6 WALL PLUG  
TASSELLO CON ALI-PA6 / BUCHA PLADUR COM ASAS-PA6



Tornillo no incluido  
Screw not included

ES El taco para pladur tipo alas (P6) es ideal para paredes de pladur, placas de cartón / yeso. Precisa menor perforación aunque sigue siendo un taco muy fuerte. Este taco, más pequeño y útil, está pensado para fijaciones de peso liviano.

FR Les chevilles pour pladur type ailettes (P6) est idéal pour des cloisons en pladur, des plaques de carton/plâtre, nécessitant une petite perforation tout en restant une cheville de fixation solide. Cette cheville, plus petite et précise, est conçue pour des fixations de poids léger.

EN Wings wall plug (p6) ideal for plaster, cardboard / plasterboard walls, less drilling needed although it is a strong wall plug. It is smaller and useful, thought to be used with light loads.

IT Il tassello "tipo ali" (P6) è ideale per pareti in cartongesso. Anche in caso di foratura meno accurata garantisce un fissaggio resistente. Questo tassello, di piccole dimensioni, è pensato per il fissaggio di pesi leggeri.

PT A bucha para pladur tipo asas (P6) é ideal para paredes de pladur, placas de cartao/gesso, presica de menos perfuração, embora seja uma bucha muito forte. Esta bucha mais pequena e útil, está feita para fixações de peso leve.

Precio x 100 unidades / Price x 100 units

Ref	Ø	Length	Medida Tornillo	Espesor Pared	Box	Price
0769 0810	8 mm	35 mm	Minimo 3,5x40	6-13 mm	50	8,74
0769 0817	8 mm	42 mm	Minimo 3,5x50	13-20 mm	50	9,66
0769 1110	10 mm	38 mm	Minimo 4x50	6-13 mm	50	10,23
0769 1117	10 mm	47 mm	Minimo 4x60	13-20 mm	50	11,42

TACO AUTOPERFORANTE / CHEVILLES AUTOPERCEUSE / SELF DRILLING PLUG  
TASELLI AUTOFORANTI / BUCHA AUTO PERFURAÇÃO

TACO NYLON AUTOPERFORANTE 6X37 CON TORNILLO 4,5X40 / CHEVILLES DE NYLON AUTOPERCEUSE 6X37 AVEC VIS 4,5X40  
SELF DRILLING NYLON PLUG 6X37 WITH SCREW 4,5X40 / TASELLI IN NYLON AUTOFORANTI 6X37 CON VITE 4,5X40  
BUCHA AUTO PERFURAÇÃO DE NYLON 6X37 COM PARAFUSO 4,5X40

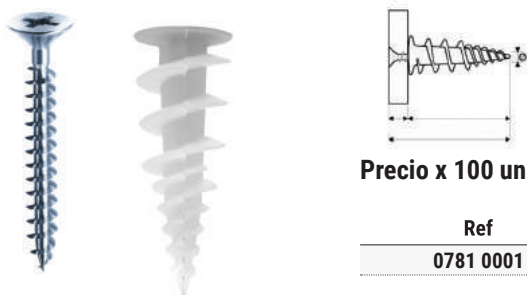

Precio x 100 unidades / Price x 100 units

Ref	Ø	Length	Box	Price
0781 0001	6 mm	37 mm	250	13,55

TACO ZAMAK AUTOPERFORANTE 6X37 CON TORNILLO 4,5X40 / CHEVILLES DE ZAMAK AUTOPERCEUSE 6X37 AVEC VIS 4,5X40  
SELF DRILLING ZAMAK PLUG 6X37 WITH SCREW 4,5X40 / TASELLI IN ZAMAK AUTOFORANTI 6X37 CON VITE 4,5X40  
BUCHA ZAMAK AUTO PERFURAÇÃO 6X37 COM PARAFUSO 4,5X40

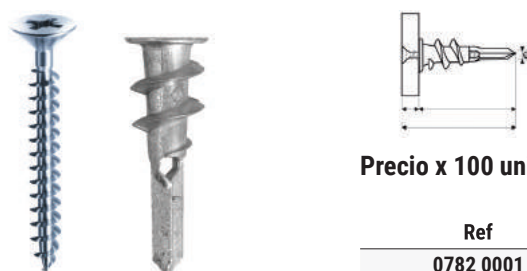

Precio x 100 unidades / Price x 100 units

Ref	Ø	Length	Box	Price
0782 0001	6 mm	37 mm	200	18,26



FIJACIÓN PARA PANELES AISLANTES / FIXATION POUR CHEVILLES POUR PANNEAUX ISOLANTS / PANEL FIX INSULATION  
FISSAGGIO DI PANNELLI ISOLANTI / FIXAÇÃO PARA PAINEL DE ISOLAMENTO

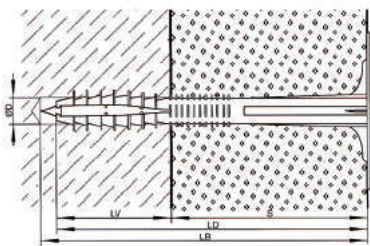

ES Aplicaciones: Especialmente indicado para aplicaciones en materiales compactos semillenos o aligerados de materiales aislantes.

FR Applications: Indiquée pour des applications sur des matériaux compacts semi légers à légers, de matériaux isolants.

EN Applications: Specially suitable for dense materials or with no insulation materials.

IT Applicazioni: Particolarmente indicato per applicazioni di materiali compatti alleggeriti o ricoperti di materiali isolanti.

PT Aplicações: Especialmente adequado para materiais densos ou materiais isolantes leves.

Precio x 100 unidades / Price x 100 units



Ref	Ø	Icon 1	Icon 2	Icon 3	Icon 4	Icon 5	Icon 6
0776 1090	10 mm	90 mm	100 mm	40 mm	40-50 mm	250	25,55
0776 1011	10 mm	110 mm	120 mm	40 mm	60-70 mm	250	27,98
0776 1013	10 mm	130 mm	140 mm	40 mm	80-90 mm	250	30,40
0776 1014	10 mm	140 mm	150 mm	40 mm	90-100 mm	250	32,44
0776 1015	10 mm	150 mm	160 mm	40 mm	100-110 mm	250	33,81
0776 1016	10 mm	160 mm	170 mm	40 mm	110-120 mm	250	34,99
0776 1017	10 mm	170 mm	180 mm	40 mm	120-130 mm	250	36,04
0776 1019	10 mm	190 mm	200 mm	40 mm	130-150 mm	250	51,30

SET 4 PCS PARA SANITARIO WC 6X80 ACERO / SET 4 PCS POUR SANITAIRE WC 6X80 ACIER / 4-PC SET FOR TOILET WC 6X80 STEEL  
SET 4 PZ PER SANITARIO WC 6X80 ACCIAIO / SET 4 PÇS PARA SANITÁRIO WC 6X80 AÇO



	Ref	M	Icon 1	Icon 2
ACERO	0760 0101	10x50/6x80 mm	1	1,92
LATÓN	0760 0102	10x50/6x80 mm	1	4,26

TACO RÁPIDO GOLPE / CHEVILLES RAPIDES / FIXING-PLUG / TASSELLO RAPIDO / BUCHA GOLPE RÁPIDO

TACO RÁPIDO GOLPE COLLARÍN AVELLANADO / CHEVILLES RAPIDES NYLON / FIXING-PLUG COUNTERSUNK  
TASSELLO RAPIDO CON TESTA SVASATA / BUCHA GOLPE RÁPIDO COM BORDA ESCAREADA



Precio x 100 unidades / Price x 100 units

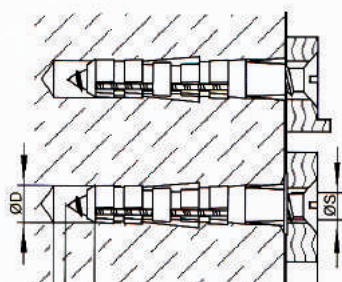

Ref	Ø	Icon 1	Icon 2	Icon 3	Icon 4	Icon 5
0770 0530	5 mm	30 mm	5 mm	100	3600	7,21
0770 0536	5 mm	36 mm	11 mm	100	2700	7,76
0770 0540	5 mm	40 mm	15 mm	100	2700	8,03
0770 0550	5 mm	50 mm	25 mm	100	2700	8,20
0770 0635	6 mm	35 mm	5 mm	100	1800	7,91
0770 0640	6 mm	40 mm	10 mm	100	1800	8,47
0770 0650	6 mm	50 mm	20 mm	100	1800	10,32
0770 0660	6 mm	60 mm	30 mm	100	1800	11,79
0770 0675	6 mm	75 mm	45 mm	100	1350	13,49
0770 0680	6 mm	80 mm	50 mm	100	1350	14,31
0770 0860	8 mm	60 mm	20 mm	100	800	17,91
0770 0880	8 mm	80 mm	40 mm	100	800	21,02
0770 0810	8 mm	100 mm	60 mm	100	800	23,42
0770 0812	8 mm	120 mm	80 mm	100	800	32,38
0770 0814	8 mm	140 mm	100 mm	50	800	37,08
0770 0816	8 mm	160 mm	120 mm	50	400	42,48



TACO GOLPE COLLARÍN AVELLANADO INOX / CHEVILLE COLLERETTE FRAISÉE INOX / HAMMER FIXING COUNTERSUNK COLLAR ST.STEEL  
TASSELLO PROLUNGATO A ESPANSIONE INOX / BUCHA GOLPE BORDA ESCAREADA INOX



INOX

Precio x 100 unidades / Price x 100 units

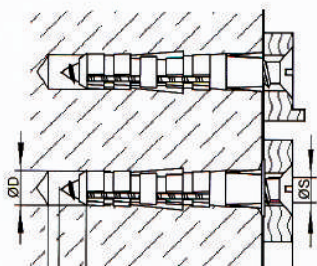

Ref	M		
0770 0635I	6x35 mm	100	24,96
0770 0640I	6x40 mm	100	24,96
0770 0650I	6x50 mm	100	26,00
0770 0660I	6x60 mm	100	28,08
0770 0670I	6x70 mm	100	57,20
0770 0680I	6x80 mm	100	42,64
0770 0860I	8x60 mm	100	60,32
0770 0880I	8x80 mm	100	61,36
0770 0810I	8x100 mm	100	71,76

TACO RÁPIDO GOLPE COLLARÍN PLANO / CHEVILLES RAPIDES NYLON / FIXING-PLUG COUNTERSUNK  
TASSELLO RAPIDO CON TESTA SVASATA / BUCHA GOLPE RÁPIDO COM BORDA ESCAREADA E PLANA



Precio x 100 unidades / Price x 100 units

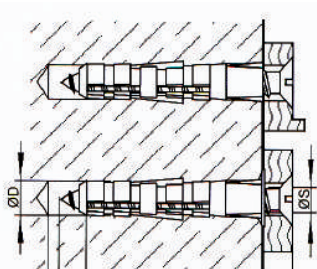

Ref						
0771 0530	5 mm	30 mm	3 mm	100	3600	7,21
0771 0536	5 mm	36 mm	9 mm	100	2700	7,76
0771 0540	5 mm	40 mm	13 mm	100	2700	8,03
0771 0550	5 mm	50 mm	23 mm	100	2700	8,20
0771 0635	6 mm	35 mm	3 mm	100	1800	7,91
0771 0640	6 mm	40 mm	8 mm	100	1800	8,47
0771 0650	6 mm	50 mm	18 mm	100	1800	10,32
0771 0660	6 mm	60 mm	28 mm	100	1800	11,79
0771 0675	6 mm	75 mm	43 mm	100	1350	13,49
0771 0680	6 mm	80 mm	48 mm	100	1350	14,31
0771 0860	8 mm	60 mm	18 mm	100	800	17,91
0771 0880	8 mm	80 mm	38 mm	100	800	21,02
0771 0810	8 mm	100 mm	58 mm	100	800	23,42
0771 0812	8 mm	120 mm	78 mm	50	800	32,38
0771 0814	8 mm	140 mm	98 mm	50	800	37,08
0771 0816	8 mm	160 mm	118 mm	50	400	42,48

TACO RÁPIDO DE GOLPE CON TIRAFONDO ROSCA M-6 INCORPORADO / CHEVILLES RAPIDES AVEC TIRE-FOND FILETÉ M-6 INCORPORÉ  
FIXING PLUG WITH M-6 POZIDRIVE SCREW / TASSELLO RAPIDO CON INCORPORATA UNA TESTA FILETTATA M-6  
BUCHA DE GOLPE RÁPIDO COM PARAFUSO DE ROSCA M-6 INCLUIDO



Precio x 100 unidades / Price x 100 units

Ref	Ø	L	M	Grid	Box	Stack
0772 0640	6 mm	40 mm	M-6 mm	100	1600	21,74

TACO LARGO CON TORNILLO TORX / CHEVILLE LONGUE AVEC VIS TORX / LONG PLUG WITH TORX SCREW  
TASSELLO LUNGO CON VITE TORX / BUCHA LONGA COM PARAFUSO TORX



ES Taco largo de nylon con una zona de expansión extralarga.  
FR Chevilles longues pourvue d'une zone d'expansion extra large.  
EN Nylon long plug with extra-long expansion area.  
IT Tassello lungo in nylon, con zona di espansione extra-lunga.  
PT Bucha longa de nylon com área de expansão extralonga.

Precio x 100 unidades  
Price x 100 units

Ref	Ø	L	W	Grid	Box	Stack
0774 0810	8 mm	100 mm	20 mm	50	400	43,58
0774 0812	8 mm	120 mm	40 mm	50	400	52,75
0774 0814	8 mm	140 mm	60 mm	50	400	59,02
0774 1010	10 mm	100 mm	20 mm	50	400	52,04
0774 1012	10 mm	120 mm	40 mm	50	400	56,13
0774 1014	10 mm	140 mm	60 mm	50	400	65,30
0774 1016	10 mm	160 mm	80 mm	50	400	81,80

TACO LARGO CON TORNILLO HEXAGONAL / CHEVILLE LONGUE AVEC VIS HEXAGONALE / LONG PLUG WITH HEXAGONAL SCREW  
TASSELLO LUNGO CON VITE ESAGONALE / BUCHA LONGA COM PARAFUSO HEXAGONAL



ES Taco largo de nylon con una zona de expansión extralarga.  
FR Chevilles longues pourvue d'une zone d'expansion extra large.  
EN Nylon long plug with extra-long expansion area.  
IT Tassello lungo in nylon, con zona di espansione extra-lunga.  
PT Bucha longa de nylon com área de expansão extralonga.

Precio x 100 unidades  
Price x 100 units

Ref	Ø	L	W	Grid	Box	Stack
0775 1010	10 mm	100 mm	20 mm	50	400	50,01
0775 1012	10 mm	120 mm	40 mm	50	400	56,62
0775 1014	10 mm	140 mm	60 mm	50	400	66,88
0775 1016	10 mm	160 mm	80 mm	50	400	86,38

TACO LARGO CON TORNILLO POZIDRIVE / NYLON LONG PLUG WITH POZIDRIVE SCREW / LONG NYLON PLUG WITH POZIDRIVE SCREW  
TASSELLO LUNGO CON VITE POZIDRIVE / BUCHA LONGA COM PARAFUSO POZIDRIVE



ES Taco largo de nylon con una zona de expansión extralarga.  
FR Chevilles longues pourvue d'une zone d'expansion extra large.  
EN Nylon long plug with extra-long expansion area.  
IT Tassello lungo in nylon, con zona di espansione extra-lunga.  
PT Bucha longa de nylon com área de expansão extralonga.

Precio x 100 unidades  
Price x 100 units

Ref	Ø	L	W	Grid	Box	Stack
0773 0810	8 mm	100 mm	20 mm	50	400	42,70
0773 0812	8 mm	120 mm	40 mm	50	400	51,98
0773 0814	8 mm	140 mm	60 mm	50	400	57,93
0773 1010	10 mm	100 mm	20 mm	50	400	51,95
0773 1012	10 mm	120 mm	40 mm	50	400	59,26
0773 1014	10 mm	140 mm	60 mm	50	400	64,16
0773 1016	10 mm	160 mm	80 mm	50	400	81,03

ANCLAJE PARA ANDAMIOS / CROCHETS POUR ÉCHAFFAUDAGE / SCAFFOLD EYEBOLD  
VITI AD OCCHIELLO PER IMPALCATURE / PARAFUSO ANCORAGEM ANDAIMES



Precio x 100 unidades / Price x 100 units

Ref	M		
0778 0001	12x90 mm	25	196,56
0778 0002	12x120 mm	25	216,32
0778 0003	12x160 mm	25	255,84

TACO EXTRA LARGO PARA ANCLAJE ANDAMIOS / CHEVILLE EXTRA-LONGUE POUR CROCHETS D'ÉCHAFFAUDAGE  
EXTRA LONG FIXING PLUG FOR SCAFFOLD EYEBOLD / TASSELLO EXTRA LUNGO PER VITI AD ACCHIELLO PER IMPALCATURE  
BUCHA EXTRA-LONGA PARA ANCORAGEM ANDAIMES



Precio x 100 unidades / Price x 100 units

Ref	M		
0779 0001	14x100 mm	50	32,76
0779 0002	16x140 mm	50	86,94

TAPÓN PARA TACO DE ANDAMIOS / BOUCHON POUR CHEVILLE D'ÉCHAFFAUDAGE / PLUG FOR SCAFFOLD FIXING PLUG  
TAPPO PER TASSELLO PER IMPALCATURE / TAMPA PARA BUCHA DE ANDAIMES



Precio x 100 unidades / Price x 100 units

Ref	M		
0780 0001	14x37 mm	100	10,71
0780 0002	14x70 mm	100	13,42

CUERPO ANCLAJE ACERO HSP / CORPS ANCRAGE ACIER HSP / HSP STEEL SHIELD ANCHOR  
CORPO ANCORANTE ACCIAIO HSP / CORPO FIXAÇÃO AÇO HSP

**ACERO**

Precio x 100 unidades / Price x 100 units



Ref	M		
0783 0640	6x40 mm	100	22,36
0783 0850	8x50 mm	50	39,00
0783 1060	10x60 mm	50	56,37
0783 1280	12x80 mm	25	93,91

CUERPO ANCLAJE ZAMAK HPM / CORPS ANCRAGE ZAMAK HPM / HPM ZAMAK SHIELD ANCHOR  
CORPO ANCORANTE ZAMAK HPM / CORPO FIXAÇÃO ZAMAK HPM

**ZAMAK**

Precio x 100 unidades / Price x 100 units





Ref	M		
0784 0645	6x45 mm	100	65,00
0784 0850	8x50 mm	50	95,58
0784 1060	10x60 mm	50	152,36
0784 1270	12x70 mm	25	231,92

ANCLAJE ZAMAK HPM CON TORNILLO 8.8 / ANCRAGE ZAMAK HPM AVEC VIS 8.8 / HPM ZAMAK ANCHOR WITH SCREW 8.8  
ANCORANTE ZAMAK HPM CON VITE 8.8 / FIXAÇÃO ZAMAK HPM COM PARAFUSO 8.8



**ZAMAK**

Precio x 100 unidades / Price x 100 units

Ref	M		
<b>0785 0650</b>	6x50 mm	100	<b>68,00</b>
<b>0785 0850</b>	8x50 mm	50	<b>130,52</b>
<b>0785 1070</b>	10x70 mm	40	<b>192,40</b>
<b>0785 1210</b>	12x100 mm	20	<b>332,80</b>

ANCLAJE METÁLICO TORNILLO HEXAGONAL 6.8 / CHEVILLES EN ACIER À VIS DE TÊTE HEXAGONALE 6.8  
STEEL BOLTS WITH HEXAGONAL HEAD SCREW 6.8 / TASSELLO METALLICO CON VITE A TESTA ESAGONALE 6.8  
BUCHA METÁLICA COM PARAFUSO HEX 6.8



ES Aplicaciones: Para la fijación de cargas pesadas en materiales macizos. Acero bicromatado, con tornillo clase 6.8 y arandelas DIN-9021.



FR Applications: Pour la fixation de charges lourdes sur des matériaux massifs, avec vis classe 6-8 et rondelle DIN-9021.

EN Applications: For fixing heavy loads in solid materials. DIN-9021 are of 6.8 resistance class.

IT Applicazioni: Per il fissaggio di oggetti pesanti su materiali massicci, con vite di classe 6.8 e rondella DIN-9021.

PT Aplicações: Para a fixação de cargas pesadas em materiais sólidos. Aço zincado com parafuso classe 6,8 e arruelas DIN-9021.

Precio x 100 unidades / Price x 100 units

Ref	Ø 	M		
<b>0762 0845</b>	8 mm	6/8x45 mm	200	<b>19,71</b>
<b>0762 0860</b>	8 mm	6/8x60 mm	200	<b>23,76</b>
<b>0762 1060</b>	10 mm	8/10x60 mm	100	<b>36,63</b>
<b>0762 1080</b>	10 mm	8/10x80 mm	50	<b>43,54</b>
<b>0762 1270</b>	12 mm	10/12x70 mm	50	<b>61,38</b>
<b>0762 1210</b>	12 mm	10/12x100 mm	50	<b>80,79</b>
<b>0762 1470</b>	14 mm	10/14x70 mm	50	<b>77,31</b>
<b>0762 1410</b>	14 mm	10/14x100 mm	25	<b>85,97</b>
<b>0762 1680</b>	16 mm	12/16x80 mm	25	<b>109,79</b>
<b>0762 1610</b>	16 mm	12/16x100 mm	25	<b>136,42</b>
<b>0762 2011</b>	20 mm	16/20x110 mm	10	<b>355,00</b>

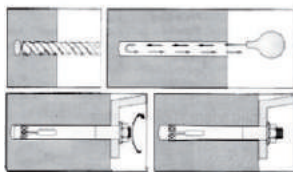

ANCLAJE METÁLICO ESPÁRRAGO / CHEVILLE METALLIQUE GOUJON / METALLIC TACO WITH THREADED ROD  
TASSELLO METALLICO PRIGIONIERO / BUCHA METÁLICA COM VARAO ROSCADO



ES Para la fijación de cargas pesadas en materiales macizos. Acero bicromatado, con tornillo clase 6,8 y arandela DIN-9021.



FR Pour la fixatons de charges lourdes sur des matériaux massifs, avec vis classe 6,8 et rondell DIN-9021.

EN For fixing heavy loads in solid materials. Din-9021 are of 6,8 resistance class.

IT Per il fissaggio di oggetti pesanti su materiali massicci, con vite di clsse 6,8 e rondella DIN-9021.

PT Para a fixação de cargas pesadas em materiais sólidos. Aço zincado com parafuso classe 6,8 e arruelas DIN-9021.

Precio x 100 unidades / Price x 100 units

Ref	Ø 	M		
<b>0764 0945</b>	9 mm	6/8x45 mm	250	<b>28,89</b>
<b>0764 1060</b>	10 mm	8/10x60 mm	100	<b>39,49</b>
<b>0764 1160</b>	11 mm	8/11x60 mm	100	<b>40,83</b>
<b>0764 1270</b>	12 mm	10/12x70 mm	100	<b>70,47</b>
<b>0764 1210</b>	12 mm	10/12x100 mm	50	<b>81,31</b>





ANCLAJE METÁLICO CON ARGOLLA / CHEVILLE METALLIQUE A BAGE / METALLIC TACO WITH RING  
TASSELLO METALLICO C/ASOLA / BUCHA METÁLICA COM ARGOLA

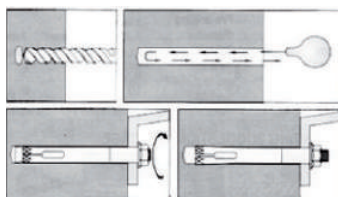

Precio x 100 unidades / Price x 100 units

Ref	Ø	M		
0765 0845	8 mm	6/8x45 mm	150	33,96
0765 1060	10 mm	8/10x60 mm	50	60,80
0765 1160	11 mm	8/11x60 mm	80	64,36
0765 1270	12 mm	10/12x70 mm	25	117,47
0765 1470	14 mm	10/14x70 mm	40	127,56
0765 1680	16 mm	12/16x80 mm	20	193,17

ANCLAJE METÁLICO CON GANCHO / CHEVILLES EN ACIER À CROCHET / STEEL BOLTS WITH HOOK  
TASSELLO METALLICO CON GANCIO / BUCHA METÁLICA COM GANCHO

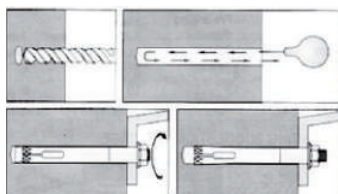

Precio x 100 unidades / Price x 100 units

Ref	Ø	M		
0766 0845	8 mm	6/8x45 mm	100	33,96
0766 0945	9 mm	6/9x45 mm	150	39,78
0766 1060	10 mm	8/10x60 mm	100	60,80
0766 1160	11 mm	8/11x60 mm	100	64,36
0766 1270	12 mm	10/12x70 mm	40	117,47
0766 1470	14 mm	10/14x70 mm	40	127,55
0766 1680	16 mm	12/16x80 mm	20	193,17

TACO ANCLAJE MTC INOX / CHEVILLE ANCRAGE MTC INOX / MTC ANCHOR BOLT ST. STEEL / TASSELLO MTC INOX / BUCHA FIXAÇÃO MTC INOX



**INOX**

Precio x 100 unidades / Price x 100 units

Ref	M		
0786 0645	6x45 mm	200	150,80
0786 0660	6x60 mm	200	154,96
0786 0875	8x75 mm	100	171,60
0786 0890	8x90 mm	100	182,00
0786 1090	10x90 mm	50	307,84
0786 1012	10x120 mm	50	374,40
0786 1211	12x110 mm	25	514,80
0786 1612	16x125 mm	10	1196,00
0786 1614	16x145 mm	10	1289,60

**ANCLAJE MACHO, PARA CARGAS ALTAS "MTC" / GOUJON D'ANCRAGE, POUR CHARGES LOURDES "MTC" / THROUGH BOLT ANCHOR, FOR HEAVY LOADS "MTC"**  
**TASSELLO ACCIAIO "MTC" / CHUMBADOR PARA CARGAS PESADAS "MTC"**



ES Anclaje standard para montajes especialmente, indicado para el hormigón y piedra natural resistente a la compresión. DIN 125 y tuerca DIN 934.





FR Goujon d'ancrage standard pour montage spécialement conçu pour le béton et la pierre naturelle résistant à la compression. DIN 125 et le boulon DIN 934.

EN Standard bolt suitable for concrete and natural stone resistant to compression. DIN 125 and nut of DIN 934.

IT Tassello standard particolarmente indicato per calcestruzzo e pietra naturale resistente alla compressione. DIN 125 e dado DIN 934.

PT Parafuso de ancoragem standard adequado para betão e pedra natural, resistente á compressão. DIN 125 e porca DIN 934.



**Precio x 100 unidades / Price x 100 units**

Ref	M			Ref	M		
0777 0640	6x45 mm	100	21,00	0777 1290	12x90 mm	50	76,44
0777 0655	6x60 mm	100	23,00	0777 1210	12x100 mm	50	105,55
0777 0685	6x80 mm	100	27,14	0777 1212	12x120 mm	50	126,44
0777 0695	6x90 mm	100	32,97	0777 1215	12x160 mm	40	165,11
0777 0850	8x50 mm	100	30,30	0777 1218	12x180 mm	30	166,92
0777 0875	8x75 mm	100	41,03	0777 1690	16x90 mm	30	168,67
0777 0810	8x115 mm	100	49,21	0777 1610	16x110 mm	30	196,74
0777 0812	8x120 mm	100	61,51	0777 1612	16x125 mm	25	234,30
0777 1060	10x70 mm	100	47,24	0777 1614	16x145 mm	25	289,34
0777 1080	10x80 mm	100	68,49	0777 1618	16x170 mm	20	297,49
0777 1010	10x100 mm	50	71,00	0777 1622	16x220 mm	10	348,16
0777 1012	10x120 mm	50	72,80	0777 2016	20x170 mm	10	449,73
0777 1270	12x70 mm	50	74,83	0777 2020	20x220 mm	10	537,56
0777 1280	12x80 mm	50	90,00	0777 2025	20x270 mm	10	734,41

**ANCLAJE MTC HOMOLOGADO CE / ANCRAGE MTC HOMOLOGUÉ CE / MTC THROUGH BOLT CE APPROVED**  
**ANCORANTE MTC OMOLOGATO CE / FIXAÇÃO MTC HOMOLOGADO CE**



**Precio x 100 unidades / Price x 100 units**

Ref	M		
0787 0875	8x75 mm	100	60,63
0787 0890	8x90 mm	100	72,07
0787 0812	8x120 mm	50	105,00
0787 1080	10x80 mm	50	82,06
0787 1090	10x90 mm	50	84,76
0787 1010	10x100 mm	50	99,53
0787 1012	10x120 mm	50	107,12
0787 1014	10x140 mm	25	137,28
0787 1016	10x160 mm	25	168,48
0787 1290	12x90 mm	25	125,84
0787 1210	12x100 mm	25	130,00
0787 1211	12x110 mm	25	136,24
0787 1212	12x120 mm	25	148,72
0787 1214	12x140 mm	25	171,60
0787 1216	12x160 mm	25	198,64
0787 1218	12x180 mm	10	223,60
0787 1612	16x125 mm	10	267,28
0787 1614	16x145 mm	10	298,48
0787 1617	16x175 mm	10	367,12



TACO METÁLICO EXPANSIÓN POR GOLPE / ANCRAGES FEMELLES À CÔNE INTÉRIEUR / STEEL DROP IN ANCHOR PLUGS  
BOCCOLA METALLICA AD ESPANSIONE / BUCHA METÁLICA DE EXPANSÃO

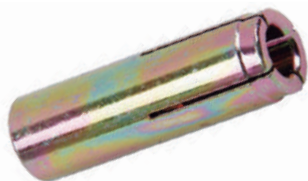

Precio x 100 unidades / Price x 100 units

Ref	M	Ø	↔	📦	📊
0767 0006	M - 6	8 mm	25 mm	100	19,57
0767 0008	M - 8	10 mm	30 mm	100	20,85
0767 0010	M - 10	12 mm	40 mm	50	32,26
0767 0012	M - 12	15 mm	50 mm	50	50,78
0767 0016	M - 16	20 mm	65 mm	25	121,68
0767 0020	M - 20	25 mm	80 mm	15	221,20

ES Características: Anclaje metálico de expansión por cono interior, con cortes verticales que evitan el giro. Utilizado para la fijación de cargas medias en todo tipo de materiales macizos.

FR Caracteristiques: Anclage métallique d'expansion par cône intérieur, avec coupures verticales qui évite toute rotation. Conçu pour être utilisé pour des charges moyennes, sur les types de matériaux massifs.

EN Features: Steel drop in anchor plug with vertical sections to avoid turnings. It is used to fix medium weights of all kinds of solid materials.

IT Caratteristiche: Tassello metallico ad espansione con interno conico e tagli verticali per evitarne la rotazione. Adatto per il fissaggio di carichi medi in ogni tipo di materiale massiccio.

PT Características: Ancoragem metálica de expansão por cone interno com cortes verticais para impedir a rotação. Usado para fixar cargas médias em todos os tipos de materiais sólidos.

INOX A-2



Precio x 100 unidades / Price x 100 units

Ref	M	Ø	↔	📦	📊
0768 0006	M - 6	8 mm	25 mm	100	131,04
0768 0008	M - 8	10 mm	30 mm	100	194,48
0768 0010	M - 10	12 mm	40 mm	50	197,32
0768 0012	M - 12	15 mm	50 mm	50	302,15

TACO DE LATÓN / FIXATION LAITON / BRASS PLUG / TASSELLO IN OTTONE / BUCHA DE LATÃO



Precio x 100 unidades / Price x 100 units

Ref	M	Ø	↔	📦	📊
0769 1004	M-4	5 mm	16 mm	300	12,25
0769 1005	M-5	6 mm	18 mm	200	15,10
0769 1006	M-6	8 mm	23 mm	200	22,93
0769 1008	M-8	10 mm	28 mm	100	37,44
0769 1010	M-10	12 mm	33 mm	50	78,21
0769 1012	M-12	15 mm	38 mm	50	161,76

KIT DE ANCLAJE COBERTOR PISCINAS (3 PIEZAS) / CHEVILLES - PISCINE (3 PIÈCE) / STEEL BOLTS - SWIMMING POOL (3 PIECES)  
TASSELLO - PISCINA (3 PEZZI) / KIT DE PISCINA, COBERTURA E ELEMENTOS DE FIXAÇÃO (3 PEÇAS)



Ref	📦	📊
0769 1500	50	1,40

ESPÁRRAGO/GANCHO BASCULANTE / GOUJON/CROCHET BASCULANT / SWING CREW/HOOK  
ANCORINA A BASCULA CON VITE/OCHIOLO APERTO / BUCHA BORBOLETA COM PERNO/GANCHO



1

1

Espárrago / Goujon / Crew / Vite / Perno

2

Gancho / Crochet / Hook / Ochiolo abierto / Gancho

Ref	M	📦	📊
1800 4601	M-4	100	0,473
1800 4602	M-5	50	0,562
1800 4603	M-6	50	0,681
1800 4604	M-8	25	1,368

Ref	M	📦	📊
1800 4701	M-4	100	0,477
1800 4702	M-5	50	0,549
1800 4703	M-6	50	0,677
1800 4704	M-8	25	1,232

GANCHO BASCULANTE C/TORNILLO / CROCHET BASCULANT AVEC VIS / SWING HOOK WITH SCREW  
GANCIO BASCULANTE CON VITE / GANCHO BASCULANTE C/PARAFUSO

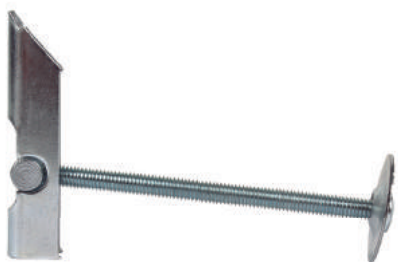

Ref	M		
1800 4610	6	50	0,718

GANCHO BASCULANTE C/ESPÁRRAGO / CROCHET BASCULANT AVEC GOUJON / SWING HOOK WITH STUD BOLT  
GANCIO BASCULANTE CON ANCORINA / GANCHO BASCULANTE C/PERNO



Ref	M		
1800 4611	6	40	0,811

GANCHO BASCULANTE C/GANCHO / CROCHET BASCULANT AVEC CROCHET / SWING HOOK WITH HOOK  
GANCIO BASCULANTE CON GANCIO / GANCHO BASCULANTE C/GANCHO



Ref	M		
1800 4612	6	40	0,811

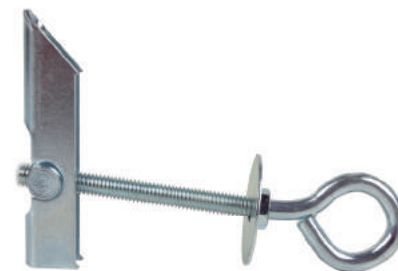

GANCHO BASCULANTE C/ANILLA / CROCHET BASCULANT AVEC ANNEAU / SWING HOOK WITH RING  
GANCIO BASCULANTE CON ANELLO / GANCHO BASCULANTE C/ANILHA



Ref	M		
1800 4613	6	40	0,811

RECAMBIO GANCHO BASCULANTE / CROCHET BASCULANT DE RECHANGE / SPARE SWING HOOK  
RICAMBIO GANCIO BASCULANTE / PEÇAS DE REPOSIÇÃO GANCHO BASCULANTE



Ref	M		
1800 4615	6	100	0,499
1800 4616	8	100	0,821

**ANCLAJE QUÍMICO POLIÉSTER SIN ESTIRENO / ANCRAGE CHIMIQUE POLYESTER SANS STYRENE / CHEMICAL ANCHOR STYRENE FREE POLYESTER  
ANCORANTE CHIMICO POLIESTERE SENZA STIRENE / BUCHA QUÍMICA POLIÉSTER SEM ESTIRENO**

ES Anclaje químico con alta resistencia a grandes cargas, adecuado para el relleno de huecos y grietas. Apto para ambientes húmedos y extremadamente versátil en albañilería y hormigón aireado. Curado rápido.

FR Ancrage chimique à haute résistance aux charges élevées, adapté au remplissage des trous et des fissures. Convient aux environnements humides et extrêmement polyvalent dans la maçonnerie et le béton cellulaire. Durcissement rapide.

EN Chemical anchor with high resistance to large loads. It is suitable for holes and cracks filling. It is intended for damp environments and is also extremely versatile for building trade and aerated concrete. Short curing time.

IT Ancorante chimico con elevata resistenza ai grossi carichi, indicato per il riempimento di fori e fessure. È destinato alle ambienti umidi e è anche estremamente versatile dalle costruzioni e il calcestruzzo aerato. Indurimento pronto.

PT Bucha química com grande resistência a grandes cargas, adquado para preencher buracos e gretas. Apto para ambientes húmidos e extremamente versátil para construção e cimento areado. Secagem rápida.

ES	Densidad aproximada / Approximate Density	<b>1,71 kg/m<sup>2</sup></b>
EN	Fuerza compresión / Compressive load (EN ISO 604)	<b>43,5 N/mm<sup>2</sup></b>
	Resistencia a la flexión / Resistance to bending (EN ISO 178)	<b>15,9 N/mm<sup>2</sup></b>
	Mínimo tiempo de curado para temperatura hormigón de 25°C (hormigón seco) Minimum curing time for temperature of concrete of 25°C (dry concrete)	<b>30 min</b>

**\* Poliéster sin estireno  
Polyester sans styrene**

Ref				
<b>1550 0130</b>	300 ml	1	12	<b>10,52</b>
<b>1550 0131</b>	410 ml	1	12	<b>13,55</b>

**MEZCLADOR ANCLAJE QUÍMICO / MELANGEUR RESINE CHIMIQUE / CHEMICAL ANCHOR MIXER NOOZLE  
MISCELATORE ANCORANTE CHIMICO / MISTURADOR FIXAÇÃO QUÍMICO**

Ref		
<b>1550 1010</b>	12	<b>0,69</b>

**TAMIZ NYLON ANCLAJE QUÍMICO / TAMIS NYLON RESINE CHIMIQUE / NYLON SLEEVE CHEMICAL ANCHOR  
TASSELLO IN NYLON PER ANCORANTE CHIMICO / PENEIRA NYLON FIXAÇÃO QUÍMICO**

Ref	M		
<b>1550 1011</b>	12x50 mm	100	<b>0,20</b>
<b>1550 1012</b>	15x85 mm	40	<b>0,24</b>
<b>1550 1013</b>	15x130 mm	30	<b>0,38</b>
<b>1550 1014</b>	20x85 mm	20	<b>0,38</b>

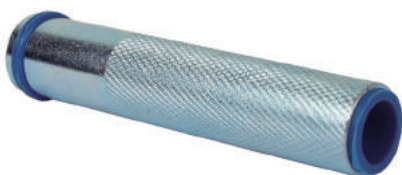
**TAMIZ ACERO ANCLAJE QUÍMICO / TAMIS ACIER RESINE CHIMIQUE / STEEL SLEEVE CHEMICAL ANCHOR  
TASSELLO IN ACCIAIO PER ANCORANTE CHIMICO / PENEIRA AÇO FIXAÇÃO QUÍMICO**

Ref	M		
<b>1550 1015</b>	6x48 mm	50	<b>0,71</b>
<b>1550 1016</b>	8x80 mm	50	<b>1,15</b>
<b>1550 1017</b>	10x80 mm	50	<b>1,31</b>
<b>1550 1018</b>	12x80 mm	50	<b>1,53</b>



REMACHADORA MANUAL, DOS MANOS PROFESIONAL / RIVETEUSE POUR RIVETS NORMAUX PROFESSIONNELLE  
 MANUAL RIVETING TOOL, TWO HANDS PROFESSIONAL / RIVETTATRICE MANUALE PER USO PROFESSIONALE  
 ALICATES PARA REBITES MANUAL, DUAS MÃOS PROFESIONAL



ES Potente línea de remachado: Fija remaches hasta 6,4 mm.  
 FR Puissante ligne de rivetage. Fixe des rivets jusqu'à 6,4mm.  
 EN Powerful riveting range: To set rivets up to 6,4 mm.  
 IT Potente linea di chiodatura: Fissa rivetti fino a 6,4 mm.  
 PT Potente linha de rebitagem: Para definir rebites até 6,4 mm.

Ref	⚙️	📦	📦
0700 1001	3,0/3,2 - 4,0 - 4,8/5,0 6,0 - 6,4	1	130,31

REMACHADORA MANUAL, DOS MANOS PROFESIONAL / D'ENGRENAGE QUI FACILITE LE RIVETAGE  
 MANUAL RIVETING TOOL, TWO HANDS PROFESSIONAL / RIVETTATRICE MANUALE PROFESSIONALE, A 2 MANI  
 ALICATES PARA REBITES MANUAL, DUAS MÃOS PROFESIONAL



**POWER SAVING DESIGN**

ES Diseño ahorro de energía, debido a su engranaje integrado. Rápido y fácil mantenimiento. Sistema de contenedor: Ofrece protección para los ojos y reserva el área de trabajo completamente limpio.  
 FR Conception pour l'économie d'énergie, grâce à l'ancrage intégré. Entretien rapide et facile. Système à réservoir: Offre une protection pour les yeux et laisse la surface de travail totalement propre.  
 EN Power saving design, 3-jaw system (Quick-maintain head). One year warranty. New patented design offers safe protection of eyes and keeps working area clean.  
 IT Grazie agli ingranaggi integrati offre un risparmio energetico. Rapido e di facile manutenzione. Sistema contenitore incluso. Nuovo brevetto, offre protezione per gli occhi e mantiene l'area di lavoro completamente pulita.  
 PT Desenho poupança de energia devido ao seu equipamento integrado. Manutenção rápida e fácil. Sistema de contentor: Novo design patenteado oferece proteção para olhos e mantém a área de trabalho completamente limpa.

Ref	⚙️	📦	📦
0700 1008	3,0/3,2 - 4,0 - 4,8/5,0 - 6,0 - 6,4	1	159,40

REMACHADORA MANUAL ESTÁNDAR / RIVETEUSE STANDARD / RIVETING TOOL STANDARD  
 RIVETTATRICE STANDARD / ALICATES PARA REBITES MANUAL STANDARD



ES Cuerpo y mangos fabricados en acero de alta resistencia. Boquillas en aleación de acero tratado al calor, intercambiables. Incluye: remachadora + 4 medidas de remaches + estuche.  
 FR Corps et manches fabriqués en acier de haute résistance. Becs en alliage d'acier traité à la chaleur. Inclus: riveteuse + 4 têtes + valisette plastique.  
 EN Heavy duty steel plate body & handle. Heat treated alloy steel jaws, hardened jaw case and nosepieces. Including: hand riveter + 4 sizes of blind rivets + plastic case.  
 IT Corpo e maniglie in acciaio ad alta resistenza. Bocche in lega di acciaio trattato termicamente. Include: rivettatrice + 4 misure di rivetti + custodia in plastica.  
 PT Corpo e pegas feitas de aço de alta resistência. Bicos em liga de aço tratado termicamente, intercambiáveis. Inclui: Alicate para rebites + 4 medidas de rebites + maleta.

Ref	⚙️	📦	📦	📄
0700 1007	2,4 - 3,0/3,2 4,0 - 4,8/5,0	1	31,85	✓

REMACADORA ESTÁNDAR / RIVETEUSE STANDARD / STANDARD RIVETER  
RIVETTATRICE STANDAR / REBITADOR STANDARD



ES Fabricada en acero de alta resistencia haciéndola, al menos, un 50% más fuerte que otras remachadoras de acero. Dos mordazas endurecidas y autolubricadas que sujetan el remache con firmeza. Boquilla endurecida para aumentar su durabilidad.

FR Fabriquée en acier à haute résistance, la rendant au moins 50% plus robuste que d'autres riveteuses en acier. Deux mors durcis et autolubrifiés qui maintiennent le rivet fermement. Bec durci pour augmenter sa longévité.

EN Manufactured from high resistant steel, making it at least, 50% stronger than other steel riveters. Two hardened and self-lubricating jaws that grip the rivet firmly.

IT Fabbricata in un acciaio ad alta resistenza che la rende più forte di almeno un 50% rispetto alle altre rivettatrici in acciaio. Due ganasce indurite e autolubrificate con una presa sicura sul rivetto. Bocchetta indurita per aumentarne la durata.

PT Fabricado em aço de alta resistência tornando-o, pelo menos, 50% mais forte do que outros rebitadores de aço. Duas garras endurecidas e auto lubrificadas que seguram o rebite firmemente. Bocal endurecido para aumentar a durabilidade.

Ref	⚙️	📦	📊	📄
0700 1009	2,4 - 3,2 4,0 - 4,8	1	26,42	✓

REMACADORA MANUAL PROFESIONAL / RIVETEUSE POUR RIVETS NORMAUX PROFESSIONNELLE  
PROFESSIONAL RIVETING TOOLS FOR BLIND RIVETS / RIVETTATRICE MANUALE PER USO PROFESSIONALE  
ALICATES PARA REBITES MANUAL PROFISSIONAL



ES Diseño dotado de gran precisión: Fácil carga, colocación y expulsión del remache. Partes duraderas: Materiales de alta calidad tratados al calor para una larga duración.

FR Conçu pour un travail de grande précision. Chargement et extraction facile du rivet. Pièces d'une grande durabilité, riel de grande qualité traité à la chaleur pour une plus grande durée.

EN Accurate design: Easy rivet loading, setting and ejection. Durable parts: High grade materials with nice heat treatment for long life operation.

IT Disegno di grande precisione: facile carico, collocazione ed espulsione del rivetto. Parti durevoli: materiali di alta qualità con trattamento termico per una lunga durata.

PT Desenho preciso: Fácil carga, colocação e ejeção. Sem problemas. Peças duráveis: materiais de alta qualidade com tratamento térmico para longa duração.

Ref	⚙️	📦	📊	📄
0700 1002	2,4 - 3,0/3,2 4,0 - 4,8/5,0	1	41,66	✓

REMACADORA MANUAL CON CABEZA GIRATORIA 360° / VEC UNE TETE ROTATIVE A 360° / 360° RATCHET-HEAD HAND RIVET TOOL  
CON TESTA GIREVOLE 360° / ALICATES PARA REBITES MANUAL COM CABEÇA ROTATIVA 360°



ES Su cabeza giratoria 360° facilita el remachado en lugares estrechos y poco accesibles desde cualquier ángulo.

FR Sa tête rotative à 360° facilite le rivetage dans des endroits étroits et avec peu d'accessibilité à partir de n'importe quel angle.

EN 360° swivel head for easy riveting in narrow and awkward places at any angle, positive.

IT La sua testa rotante a 360° facilita la rivettatura in punti stretti e poco accessibili da qualunque angolo.

PT Cabeça giratória 360° para rebitar facilmente em lugares estreitos e pouco acessíveis desde qualquer ângulo.

Ref	⚙️	📦	📊	📄
0700 1003	2,4 - 3,0/3,2 4,0 - 4,8/5,0	1	44,36	✓

REMACADORA PARA TUERCAS REMACHABLES PROFESIONAL / RIVETEUSE POUR ECROUS-RIVETS PROFESSIONNELLE  
PROFESSIONAL RIVETING TOOLS FOR BLIND RIVET NUTS / RIVETTATRICE A LEVA PER BOCCOLE-DADO RIBATTIBILI PROFESSIONALE  
ALICATE PARA PORCAS DE CRAVAR PROFISSIONAL



ES Fuerte estructura: Cuerpo de aluminio de alta resistencia, mangos en acero.

FR Solide structure. Corps en aluminium de haute résistance, manche en acier.

EN Robust structure: High strength aluminium alloy body, high tension steel handles.

IT Robusta struttura: Corpo in alluminio ad alta resistenza, manici in acciaio.

PT Estrutura forte: Corpo de alumínio de grande resistência, pegas em aço.

	Ref	⚙️	📦	📊	📄
1	0700 1004	M-3, M-4, M-5, M-6	1	92,97	✓
2	0700 1005	M-5, M-6, M-8, M-10	1	395,40	
3	0700 1006	M-5, M-6, M-8, M-10, M-12	1	395,40	

REMACHES ESTÁNDAR CABEZA ALOMADA / RIVETS ALUMINIUM STANDARD / ALUMINIUM STANDARD DOME HEAD  
RIVETTO IN ALLUMINIO STANDARD, TESTA BOMBATA / REBITES STANDARD CABEÇA ABAULADA

Precio x 1000 unidades / Price x 1000 units



← Aluminium  
← Zinc plated stell

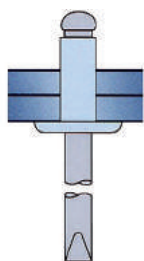

Ref	Ø			Ref	Ø		
0701 2404	2,4x04 mm	1000	55,00	0701 4808	4,8x08 mm	1000	35,40
0701 2406	2,4x06 mm	1000	31,20	0701 4810	4,8x10 mm	500	39,20
0701 2408	2,4x08 mm	1000	32,80	0701 4812	4,8x12 mm	500	44,50
0701 2410	2,4x10 mm	1000	34,10	0701 4814	4,8x14 mm	500	49,30
0701 2412	2,4x12 mm	1000	35,50	0701 4816	4,8x16 mm	500	51,50
0701 3006	3,0x06 mm	1000	24,10	0701 4818	4,8x18 mm	500	57,20
0701 3008	3,0x08 mm	1000	26,90	0701 4820	4,8x20 mm	500	69,00
0701 3010	3,0x10 mm	1000	27,90	0701 4825	4,8x25 mm	250	75,80
0701 3012	3,0x12 mm	1000	31,80	0701 4830	4,8x30 mm	250	90,10
0701 3014	3,0x14 mm	1000	38,10	0701 4835	4,8x35 mm	250	102,40
0701 3016	3,0x16 mm	1000	40,00	0701 4840	4,8x40 mm	250	114,80
0701 3018	3,0x18 mm	1000	49,00	0701 4850	4,8x50 mm	250	144,40
0701 3206	3,2x06 mm	1000	24,10	0701 6008	6,0x08 mm	500	79,00
0701 3208	3,2x08 mm	1000	26,90	0701 6010	6,0x10 mm	500	83,70
0701 3210	3,2x10 mm	1000	27,90	0701 6012	6,0x12 mm	500	87,20
0701 3212	3,2x12 mm	1000	31,80	0701 6015	6,0x15 mm	250	89,60
0701 3214	3,2x14 mm	1000	38,10	0701 6018	6,0x18 mm	250	94,70
0701 3216	3,2x16 mm	1000	38,10	0701 6022	6,0x22 mm	250	99,10
0701 3218	3,2x18 mm	1000	48,90	0701 6026	6,0x26 mm	250	105,50
0701 3406	3,4x06 mm	1000	24,90	0701 6030	6,0x30 mm	250	121,50
0701 3409	3,4x09 mm	1000	28,80	0701 6035	6,0x35 mm	250	145,90
0701 3412	3,4x12 mm	1000	33,10	0701 6040	6,0x40 mm	200	184,70
0701 3414	3,4x14 mm	1000	35,30	0701 6408	6,4x08 mm	500	88,50
0701 3416	3,4x16 mm	1000	40,40	0701 6410	6,4x10 mm	250	93,90
0701 3418	3,4x18 mm	1000	42,60	0701 6412	6,4x12 mm	250	95,80
0701 3420	3,4x20 mm	1000	50,20	0701 6415	6,4x15 mm	250	100,90
0701 4006	4,0x06 mm	1000	25,50	0701 6418	6,4x18 mm	250	109,20
0701 4008	4,0x08 mm	1000	27,00	0701 6422	6,4x22 mm	250	120,40
0701 4010	4,0x10 mm	1000	29,30	0701 6426	6,4x26 mm	250	125,20
0701 4012	4,0x12 mm	1000	34,20	0701 6430	6,4x30 mm	250	143,60
0701 4014	4,0x14 mm	1000	36,70	0701 6435	6,4x35 mm	250	184,90
0701 4016	4,0x16 mm	500	40,00	0701 6440	6,4x40 mm	250	206,90
0701 4018	4,0x18 mm	500	43,60	0701 7815	7,8x15 mm	250	162,00
0701 4020	4,0x20 mm	500	63,70	0701 7818	7,8x18 mm	250	168,60
0701 4025	4,0x25 mm	500	79,30	0701 7822	7,8x22 mm	200	188,90
0701 4030	4,0x30 mm	500	80,00	0701 7826	7,8x26 mm	250	209,10

REMACHE ALUMINIO ESTÁNDAR EN COLORES / RIVETS ALU STANDARD COULEURS / PAINTED ALUMINIUM RIVETS  
RIVETTO IN ALLUMINIO STANDARD TESTA COLORATA / REBITES ALUMÍNIO STANDARD EM CORES



← Aluminium  
← Zinc plated stell



Ref		Ø			Ref		Ø		
0715 3208		3,2x08 mm	1000	43,40	0715 3208N		3,2x08 mm	1000	43,40
0715 3210		3,2x10 mm	1000	45,50	0715 3210N		3,2x10 mm	1000	45,50
0715 3212		3,2x12 mm	1000	47,90	0715 3212N		3,2x12 mm	1000	47,90
0715 3215		3,2x15 mm	1000	59,10	0715 3215N		3,2x15 mm	1000	59,10
0715 4008		4,0x08 mm	1000	50,40	0715 4008N		4,0x08 mm	1000	50,40
0715 4010		4,0x10 mm	1000	56,20	0715 4010N		4,0x10 mm	1000	56,20
0715 4012		4,0x12 mm	1000	57,00	0715 4012N		4,0x12 mm	1000	57,00
0715 4014		4,0x14 mm	1000	60,50	0715 4014N		4,0x14 mm	1000	60,50
0715 4016		4,0x16 mm	500	70,40	0715 4016N		4,0x16 mm	500	70,40
0715 4018		4,0x18 mm	500	77,60	0715 4018N		4,0x18 mm	500	77,60
0715 4020		4,0x20 mm	500	83,60	0715 4020N		4,0x20 mm	500	83,60
0715 4808		4,8x08 mm	1000	60,30	0715 4808N		4,8x08 mm	1000	60,30
0715 4810		4,8x10 mm	500	65,10	0715 4810N		4,8x10 mm	500	65,10
0715 4812		4,8x12 mm	500	72,50	0715 4812N		4,8x12 mm	500	72,50
0715 4814		4,8x14 mm	500	78,80	0715 4814N		4,8x14 mm	500	78,80
0715 4816		4,8x16 mm	500	85,90	0715 4816N		4,8x16 mm	500	85,90
0715 4818		4,8x18 mm	500	97,50	0715 4818N		4,8x18 mm	500	97,50
0715 4821		4,8x21 mm	500	110,80	0715 4821N		4,8x21 mm	500	110,80
0715 4830		4,8x30 mm	500	144,30	0715 4830N		4,8x30 mm	500	144,30

REMACHES ALUMINIO ESTÁNDAR CABEZA ANCHA / RIVETS ALU LEVRE LARGE / ALUMINIUM STANDARD LARGE HEAD  
RIVETTO IN ALLUMINIO A TESTA LARGA / REBITES ALUMÍNIO STANDARD CABEÇA GRANDE

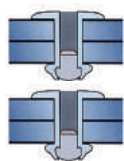
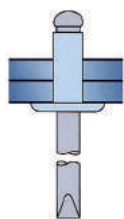
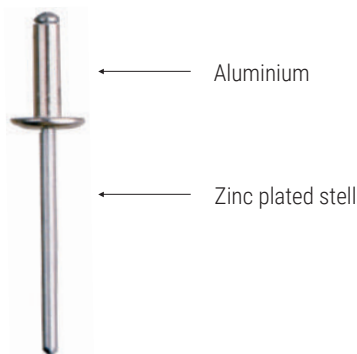

**ESTÁNDAR  
ALA ANCHA**

**Precio x 1000 unidades / Price x 1000 units**

Ref	Ø	Ø <sub>2</sub>		
0704 3210	3,2x10 mm	9,5 mm	1000	49,00
0704 3212	3,2x12 mm	9,5 mm	1000	60,07
0704 3214	3,2x14 mm	9,5 mm	1000	61,80
0704 4008	4,0x08 mm	12 mm	500	40,50
0704 4010	4,0x10 mm	12 mm	500	51,40
0704 4012	4,0x12 mm	12 mm	500	51,90
0704 4014	4,0x14 mm	12 mm	500	72,40
0704 4016	4,0x16 mm	12 mm	500	74,50
0704 4018	4,0x18 mm	12 mm	500	79,10
0704 4020	4,0x20 mm	12 mm	500	82,30
0704 4808	4,8x08 mm	14 mm	500	52,50
0704 4810	4,8x10 mm	14 mm	500	59,80
0704 4812	4,8x12 mm	14 mm	500	67,50
0704 4816	4,8x16 mm	14 mm	250	87,60
0704 4818	4,8x18 mm	14 mm	250	96,90
0704 4820	4,8x20 mm	14 mm	250	110,30
0704 4826	4,8x26 mm	14 mm	250	130,40
0705 4812	4,8x12 mm	16 mm	250	74,50
0705 4816	4,8x16 mm	16 mm	250	96,10
0705 4818	4,8x18 mm	16 mm	250	106,50
0705 4826	4,8x26 mm	16 mm	250	130,90
0705 4830	4,8x30 mm	16 mm	250	137,20
0705 4835	4,8x35 mm	16 mm	250	141,40

REMACHE ESTÁNDAR CABEZA AVELLANADA 120° / RIVETS FRAISES ALU STANDARD 120° / ALUMINIUM STANDARD COUNTERSUNK HEAD 120°  
RIVETTI A TESTA SVASATA 120° IN ALLUMINIO / REBITES STANDARD CABEÇA ESCAREDA 120°

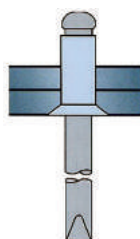

ES Remaches avellanados en aluminio con vástago de acero. Su cabeza forma un ángulo de 120° lo que consigue que al remachar sobre una superficie, no sobresalga la cabeza del remache.

FR Rivets fraisés en aluminium avec embout en acier. Sa tête forme un angle à 120° ce qui l'empêche de ressortir de la surface.

EN Steel body standard rivets with aluminium countersunk head. 120° head allows you to obtain flat surface over riveted parts, the rivet head doesn't protrude.

IT Rivetti in alluminio con testa svasata e gambo in acciaio. La testa forma un angolo di 120° assicurando che non sporga la testa dello stesso sulla superficie sul quale è applicato.

PT Rebitos escareados em alumínio com haste de aço. Sua cabeça forma um ângulo de 120° para que o rebite ao ficar em uma superfície, a cabeça do rebite não fique saliente.

**Precio x 1000 unidades / Price x 1000 units**

Ref	Ø		
0722 3208	3,2 x 8 mm	1000	26,30
0722 3210	3,2 x 10 mm	1000	29,00
0722 3212	3,2 x 12 mm	1000	31,30
0722 3214	3,2 x 14 mm	1000	35,30
0722 4008	4,0 x 8 mm	1000	28,70
0722 4010	4,0 x 10 mm	1000	30,70
0722 4012	4,0 x 12 mm	1000	35,90
0722 4014	4,0 x 14 mm	1000	40,30
0722 4016	4,0 x 16 mm	500	44,50
0722 4018	4,0 x 18 mm	500	47,70
0722 4808	4,8 x 8 mm	500	33,90
0722 4810	4,8 x 10 mm	500	37,30
0722 4812	4,8 x 12 mm	500	42,20
0722 4814	4,8 x 14 mm	500	51,90
0722 4816	4,8 x 16 mm	500	54,80
0722 4818	4,8 x 18 mm	500	62,20
0722 4820	4,8 x 20 mm	500	69,20

REMACHES ALUMINIO FLOR CABEZA ALOMADA / RIVETS ALU FLEUR / PEEL RIVETS ALLUMINIUM DOME HEAD  
RIVETTO IN ALLUMINIO A FIORE / REBITES ALUMÍNIO FLOR, CABEÇA ABAULADA

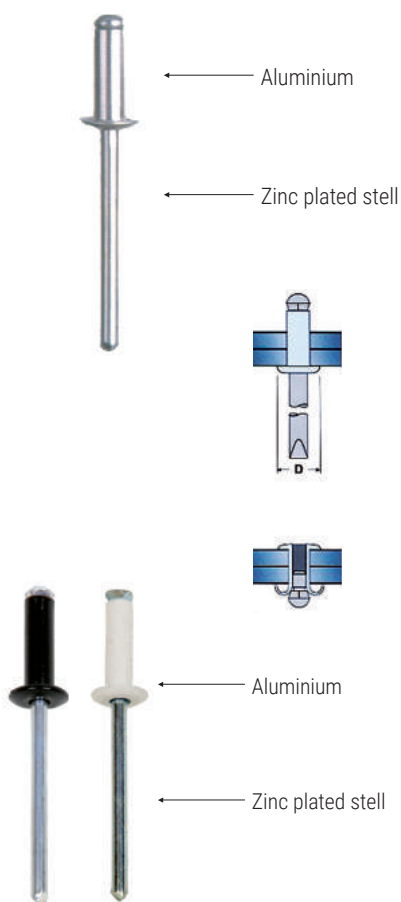

ES El remache flor se abre en cuatro pétalos consiguiendo una mayor superficie posterior de apoyo.  
FR Le rivet fleur à quatre pétales assure une plus grande surface d'appui.  
EN Flower head rivet, grip to the material by opening its four petals.  
IT Il rivetto a fiore si apre in 4 petali ottenendo una maggiore superficie posteriore di appoggio.  
PT O rebite flor abre-se como que em 4 pétalas alcançando uma maior superfície posterior de apoio.

**Precio x 1000 unidades / Price x 1000 units**

Ref	Ø	Ø <sub>2</sub>		
0720 4012	4,0 x 12 mm	8 mm	1000	<b>55,40</b>
0720 4016	4,0 x 16 mm	8 mm	500	<b>73,50</b>
0720 4020	4,0 x 20 mm	8 mm	500	<b>102,40</b>
0720 4026	4,0 x 26 mm	8 mm	500	<b>103,40</b>
0720 4030	4,0 x 30 mm	8 mm	500	<b>115,20</b>
0720 4812	4,8 x 12 mm	9,5 mm	500	<b>71,20</b>
0720 4816	4,8 x 16 mm	9,5 mm	500	<b>92,00</b>
0720 4821	4,8 x 21 mm	9,5 mm	500	<b>116,20</b>
0720 4826	4,8 x 26 mm	9,5 mm	250	<b>137,40</b>
0720 4830	4,8 x 30 mm	9,5 mm	250	<b>151,90</b>
0720 4835	4,8 x 35 mm	9,5 mm	250	<b>158,30</b>
0720 4840	4,8 x 40 mm	9,5 mm	250	<b>167,30</b>
0720 4850	4,8 x 50 mm	9,5 mm	250	<b>256,40</b>

**Precio x 1000 unidades / Price x 1000 units**

Ref		Ø			Ref		Ø		
0720 4016N		4,0 x 16 mm	500	<b>101,80</b>	0720 4016BL		4,0 x 16 mm	500	<b>101,80</b>
0720 4020N		4,0 x 20 mm	500	<b>107,10</b>	0720 4020BL		4,0 x 20 mm	500	<b>107,10</b>
0720 4816N		4,8 x 16 mm	500	<b>125,10</b>	0720 4816BL		4,8 x 16 mm	500	<b>125,10</b>
0720 4821N		4,8 x 21 mm	500	<b>117,70</b>	0720 4821BL		4,8 x 21 mm	500	<b>127,50</b>

REMACHES ALUMINIO FLOR CABEZA ANCHA / RIVETS ALU FLEUR LEVRE LARGE / ALUMINIUM PEEL RIVETS - LARGE HEAD  
RIVETTO IN ALLUMINIO A FIORE TESTA LARGA / REBITES ALUMÍNIO FLOR, CABEÇA GRANDE



ES El remache flor se abre en cuatro pétalos consiguiendo una mayor superficie posterior de apoyo.  
FR Le rivet fleur à quatre pétales assure une plus grande surface d'appui.  
EN Flower head rivet, grip to the material by opening its four petals.  
IT Il rivetto a fiore si apre in 4 petali ottenendo una maggiore superficie posteriore di appoggio.  
PT O rebite flor abre-se como que em 4 pétalas alcançando uma maior superfície posterior de apoio.

**FLOR ALA ANCHA**

**Precio x 1000 unidades / Price x 1000 units**

Ref	Ø	Ø <sub>2</sub>		
0723 4016	4,0 x 16 mm	10 mm	500	<b>99,40</b>
0723 4020	4,0 x 20 mm	10 mm	500	<b>138,30</b>
0723 4812	4,8 x 12 mm	14 mm	500	<b>93,80</b>
0723 4816	4,8 x 16 mm	14 mm	250	<b>122,50</b>
0723 4821	4,8 x 21 mm	14 mm	250	<b>148,50</b>
0723 4826	4,8 x 26 mm	14 mm	250	<b>177,70</b>
0723 4830	4,8 x 30 mm	14 mm	250	<b>193,80</b>
0723 4835	4,8 x 35 mm	14 mm	250	<b>260,10</b>



REMACHES ALUMINIO FLOR CABEZA ANCHA DE COLORES / RIVETS ALU FLEUR LÈVRE LARGE / PEEL RIVETS ALUMINIUM LARGE HEAD  
RIVETTO IN ALLUMINIO A FIORE TESTA LARGA / REBITES ALUMÍNIO FLOR, CABEÇA GRANDE

**FLOR ALA ANCHA**

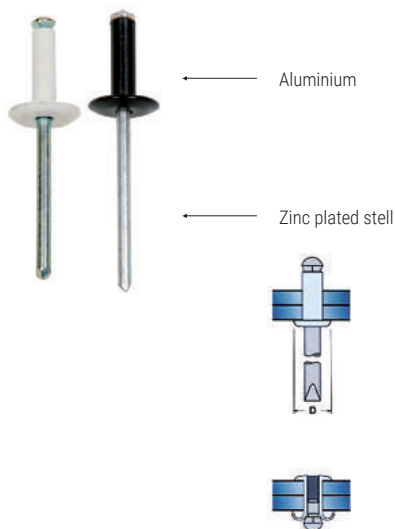

ES El remache flor se abre en cuatro pétalos consiguiendo una mayor superficie posterior de apoyo.  
FR Le rivet fleur à quatre pétales assure une plus grande surface d'appui.  
EN Flower head rivet, grip to the material by opening its four petals.  
IT Il rivetto a fiore si apre in 4 petali ottenendo una maggiore superficie posteriore di appoggio.  
PT O rebite flor abre-se como que em 4 pétalas alcançando uma maior superfície posterior de apoio.

**Precio x 1000 unidades / Price x 1000 units**

Ref		Ø	Ø <sub>2</sub>		
0723 4016BL		4,0 x 16 mm	10 mm	500	194,00
0723 4816BL		4,8 x 16 mm	16 mm	250	198,20
0723 4821BL		4,8 x 21 mm	16 mm	250	238,50
0723 4016N		4,0 x 16 mm	16 mm	250	194,00
0723 4816N		4,8 x 16 mm	16 mm	250	198,20
0723 4821N		4,8 x 21 mm	16 mm	250	238,50

REMACHES MULTIGRIP / RIVETS UNIGRIP / UNIGRIP RIVETS / RIVETTI UNIGRIP / REBITES MULTIGRIP



ES El remache MultiGrip es un remache multi-espesor, creando uniones totalmente estancas, resistentes a vibraciones y pueden proporcionar sellados herméticos frente a condiciones climáticas.  
FR Le rivet Multi Grip est un rivet multi-épaisseur, permettant des unions totalement étanches, résistantes aux vibrations et permettant une fermeture hermétique face à toute condition climatique.  
EN The Multi Grip rivet is thick creating a joint totally airtight, resistant to vibrations and can provide hermetic seal against climatic changes.  
IT Il rivetto multi-grip è un rivetto multispessore, creando unioni totalmente impermeabili, resistenti alle vibrazioni e possono fornire chiusure ermetiche per le condizioni meteorologiche.  
PT O rebite Multigrip é um rebite multi- espessura, criando juntas totalmente à prova d'água, resistentes a vibrações e podem fornecer uma vedação hermética frente a condições climáticas.

**MULTIGRIP**

**Precio x 1000 unidades / Price x 1000 units**



Ref	Ø		
0706 3208	3,0 x 08 mm	1000	40,20
0706 3211	3,2 x 11 mm	1000	57,20
0706 4010	4,0 x 10 mm	1000	57,20
0706 4013	4,0 x 13 mm	1000	62,40
0706 4017	4,0 x 17 mm	500	67,40
0706 4811	4,8 x 11 mm	500	76,30
0706 4815	4,8 x 15 mm	500	84,70
0706 4817	4,8 x 17 mm	500	101,30
0706 4825	4,8 x 25 mm	500	124,70



**MULTIGRIP ALA ANCHA**

**Precio x 1000 unidades / Price x 1000 units**

Ref	Ø		
0707 4810	4,8 x 10 mm	250	106,70
0707 4816	4,8 x 16 mm	250	126,50
0707 4825	4,8 x 25 mm	250	148,50

REMACHES ALUMINIO TRÉBOL CABEZA ALOMADA / RIVETS ALU TREFLE / TRIBLOC - ALUMINIUM RIVETS  
RIVETTO IN ALLUMINIO A TRIFOGLIO / REBITES ALUMÍNIO TRÉBOL, CABEÇA ABAULADA

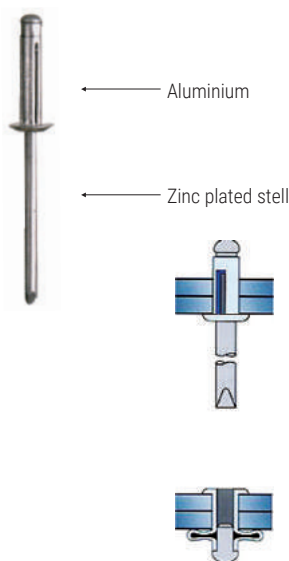

**TRÉBOL**

ES Diseñado para fijar materiales rígidos a blandos y blandos a blandos, como metal a plástico o plástico a plástico.  
FR Le rivet trêfle est conçu pour fixer des éléments rigides à tendres, comme métal sur plastique.  
EN Trebol rivets are designed to be used with rigid to soft and soft to soft materials, as metal to plastic or plastic to plastic.  
IT Il rivetto a trifoglio è concepito per chiodare elementi rigidi su materiali morbidi o rigidi come: metallo su plastica o plastica su plastica.  
PT Rebitos Trébol são concebidos para fixarem materiais rígidos para suaves, e suaves para suaves, como metal para plástico ou plástico para plástico.

**Precio x 1000 unidades / Price x 1000 units**

Ref	Ø		
<b>0721 4013</b>	4,0 x 13 mm	500	<b>124,40</b>
<b>0721 4018</b>	4,0 x 18 mm	500	<b>132,00</b>
<b>0721 4815</b>	4,8 x 15 mm	500	<b>125,90</b>
<b>0721 4820</b>	4,8 x 20 mm	250	<b>141,30</b>
<b>0721 4824</b>	4,8 x 24 mm	250	<b>157,10</b>

REMACHES INOX A-2 CABEZA ALOMADA / RIVETS ACIER INOX A-2 / INOX A-2 PLATED STEEL RIVETS TAINLESS STEEL RIVETS D  
RIVETTI IN ACCIAIO INOX A-2 / REBITES INOX A-2 CABEÇA ABAULADA

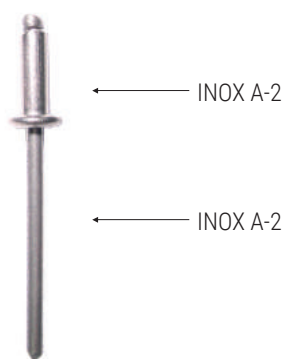

**INOX A-2**

ES El remache inox está especialmente indicado donde tengamos problemas de oxidación, en zonas marítimas, para fijar elementos inoxidables como muebles metálicos, para alimentación e industria naval.  
FR Le rivet inox est particulièrement indiqué sur des applications sujettes à des contraintes d'oxydation, pour la fixation d'éléments inoxydables, meubles métalliques, alimentation industrielle et navale, zones maritimes.  
EN Stainless steel rivets are used whenever there is a problem or risk of oxidation (Marine areas), to fix stainless elements.  
IT Questi rivetti in acciaio inox, sono indicati in applicazioni in cui esistono problemi di ossidazione, in zone marittime e per fissare elementi in acciaio inossidabile, come mobili metallici per l'alimentazione e per l'industria navale.  
PT O rebite inox está especialmente indicado onde há problemas de oxidação, em zonas marítimas, para fixar materiais inoxidáveis como móveis para alimentação e indústria naval.

**Precio x 1000 unidades / Price x 1000 units**

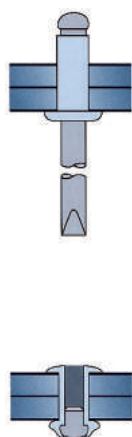

Ref	Ø		
<b>0702 3006</b>	3,0 x 06 mm	1000	<b>86,70</b>
<b>0702 3008</b>	3,0 x 08 mm	1000	<b>93,00</b>
<b>0702 3010</b>	3,0 x 10 mm	1000	<b>99,50</b>
<b>0702 3012</b>	3,0 x 12 mm	1000	<b>129,40</b>
<b>0702 3206</b>	3,2 x 06 mm	1000	<b>121,60</b>
<b>0702 3208</b>	3,2 x 08 mm	1000	<b>131,80</b>
<b>0702 3210</b>	3,2 x 10 mm	1000	<b>148,90</b>
<b>0702 3212</b>	3,2 x 12 mm	1000	<b>173,00</b>
<b>0702 4006</b>	4,0 x 06 mm	1000	<b>154,00</b>
<b>0702 4008</b>	4,0 x 08 mm	1000	<b>213,10</b>
<b>0702 4010</b>	4,0x 10 mm	1000	<b>206,30</b>
<b>0702 4012</b>	4,0 x 12 mm	1000	<b>226,80</b>
<b>0702 4014</b>	4,0 x 14 mm	1000	<b>250,90</b>
<b>0702 4016</b>	4,0 x 16 mm	500	<b>285,20</b>
<b>0702 4808</b>	4,8 x 08 mm	500	<b>210,40</b>
<b>0702 4810</b>	4,8 x 10 mm	500	<b>223,40</b>
<b>0702 4812</b>	4,8 x 12 mm	500	<b>240,60</b>
<b>0702 4814</b>	4,8 x 14 mm	500	<b>285,20</b>
<b>0702 4816</b>	4,8 x 16 mm	500	<b>319,70</b>
<b>0702 4818</b>	4,8 x 18 mm	500	<b>442,10</b>
<b>0702 4820</b>	4,8 x 20 mm	500	<b>528,50</b>
<b>0702 6412</b>	6,4 x 12 mm	250	<b>712,30</b>
<b>0702 6415</b>	6,4 x 15 mm	250	<b>844,80</b>
<b>0702 6418</b>	6,4 x 18 mm	250	<b>865,00</b>
<b>0702 6422</b>	6,4 x 22 mm	250	<b>981,60</b>

REMACHES TODO ACERO CABEZA ALOMADA / RIVETS ACIER PROTECTION ZINGUÉE / ZINC PLATED STEEL RIVETS  
RIVETTI IN ACCIAIO ZINCATO A TESTA BOMBATA / REBITES EM AÇO, CABEÇA ABAULADA

**ACERO Precio x 1000 unidades / Price x 1000 units**

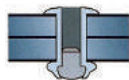
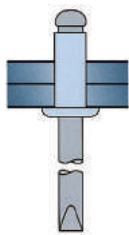
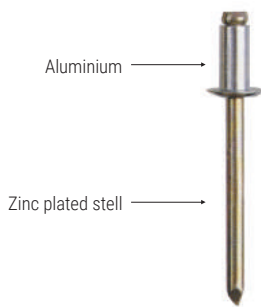

Ref	Ø		
0703 3206	3,2 x 06 mm	1000	29,20
0703 3208	3,2 x 08 mm	1000	35,00
0703 3210	3,2 x 10 mm	1000	39,00
0703 3212	3,2 x 12 mm	1000	50,80
0703 4006	4,0 x 06 mm	1000	40,00
0703 4008	4,0 x 08 mm	1000	50,10
0703 4010	4,0 x 10 mm	1000	51,40
0703 4012	4,0 x 12 mm	1000	63,20
0703 4014	4,0 x 14 mm	1000	70,60
0703 4018	4,0 x 18 mm	500	93,50
0703 4020	4,0 x 20 mm	500	96,10
0703 4024	4,0 x 24 mm	500	101,10
0703 4030	4,0 x 30 mm	500	130,20
0703 4810	4,8 x 10 mm	500	59,60
0703 4812	4,8 x 12 mm	500	63,10
0703 4814	4,8 x 14 mm	500	80,20
0703 4816	4,8 x 16 mm	500	86,00
0703 4818	4,8 x 18 mm	500	97,40
0703 4820	4,8 x 20 mm	500	108,90
0703 4824	4,8 x 24 mm	250	143,20
0703 4830	4,8 x 30 mm	250	181,70
0703 6012	6,0 X 12 mm	250	115,80
0703 6015	6,0 x 15 mm	250	120,30
0703 6018	6,0 x 18 mm	250	148,10
0703 6022	6,0 x 22 mm	250	158,90
0703 6026	6,0 x 26 mm	250	185,10
0703 6030	6,0 x 30 mm	200	192,80

REMACHES COBRE - ACERO CABEZA ALOMADA / RIVETS CUIVRE - ACIER / COPPER RIVETS - ZINC PLATED STEEL NAIL  
RIVETTO IN RAME CON CHIEDO IN ACCIAIO ZINCATO / REBITES COBRE-AÇO CABEÇA ABAULADA

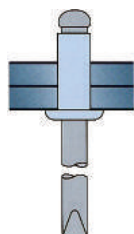
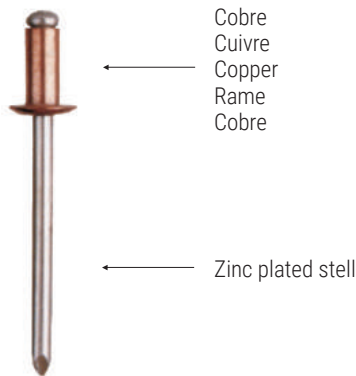

**COBRE - ACERO**

ES El remache cobre / acero es específico para remachar elementos de cobre o latón.  
FR Le rivet cuivre/acier est destiné à la fixation de pièces en cuivre ou en laiton.  
EN Copper / Steel rivets are specific to be used with copper or brass elements.  
IT Rivetti in rame con chiedo in acciaio zincato.  
PT Especifico para a junção de elementos em cobre ou latão.

**Precio x 1000 unidades / Price x 1000 units**

Ref	Ø		
0716 3006	3,0 x 06 mm	1000	45,10
0716 3009	3,0 x 09 mm	1000	48,30
0716 3011	3,0 x 11 mm	1000	50,50
0716 3014	3,0 x 14 mm	1000	64,20
0716 4007	4,0 x 07 mm	1000	78,50
0716 4009	4,0 x 09 mm	1000	89,30
0716 4012	4,0 x 12 mm	1000	103,10
0716 4014	4,0 x 14 mm	1000	110,20
0716 4016	4,0 x 16 mm	500	124,00
0716 4810	4,8 x 10 mm	500	129,30
0716 4812	4,8 x 12 mm	500	144,20
0716 4814	4,8 x 14 mm	500	161,40

REMACHES COBRE - BRONCE / RIVETS CUIVRE - BRONZE / COPPER RIVETS - BRASS NAIL  
RIVETTI IN RAME CON CHIEDO IN OTTONE / REBITES COBRE-BRONZE

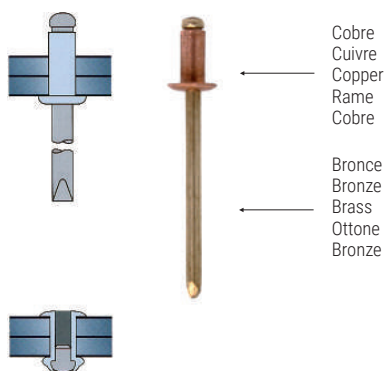

**COBRE - BRONCE**

**Precio x 1000 unidades / Price x 1000 units**

Ref	Ø		
0717 3207	3,2 x 07 mm	1000	<b>110,00</b>
0717 3211	3,2 x 11 mm	1000	<b>115,80</b>
0717 4006	4,0 x 06 mm	1000	<b>160,40</b>
0717 4007	4,0 x 07 mm	1000	<b>175,30</b>
0717 4009	4,0 x 09 mm	1000	<b>182,10</b>
0717 4011	4,0 x 11 mm	1000	<b>190,90</b>

ES Utilizado para remachar elementos de cobre o latón y donde tengamos problemas de oxidación.  
FR Destiné à la fixation de pièces en cuivre ou en laiton sur des applications sujettes à des contraintes d'oxydation.  
EN Used with copper or brass elements and wherever is oxidation.  
IT Utilizzati per il fissaggio di pezzi in rame od ottone e su oggetti in cui si hanno problemi di ossidazione.  
PT Utilizados para elementos em cobre ou bronze onde há problemas de oxidação.

REMACHES ACERO ESTRUCTURAL CABEZA ALOMADA / RIVETS STRUCTURES / STEEL STRUCTURAL DOME HEAD  
RIVETTO IN ACCIAIO STRUTTURALE / REBITE AÇO ESTRUTURAL CABEÇA ABAULADA

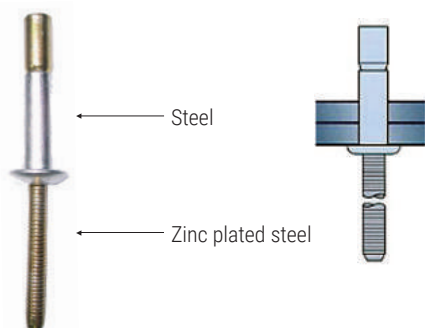

**ACERO**

**Precio x 1000 unidades / Price x 1000 units**

Ref	Ø		
0710 4810	4,8 x 10 mm	500	<b>257,80</b>
0710 4814	4,8 x 14 mm	500	<b>278,10</b>
0710 6514	6,5 x 14 mm	250	<b>401,00</b>
0710 6520	6,5 x 20 mm	250	<b>450,80</b>

ES El remache estructural está diseñado para la fijación de elementos de acero, donde se requiera una gran resistencia.  
FR Le rivet structurel est conçu pour la fixation d'éléments en acier qui sollicitent une résistance importante.  
EN Structural rivets are designed to be used with steel elements, when is required a special resistance.  
IT Il rivetto strutturale è disegnato per il fissaggio di elementi in acciaio, dove è richiesta una elevata resistenza.  
PT Concebido para a fixação de elementos de aço, onde é requerida grande resistência.

REMACHES ESTANCO CABEZA ALOMADA / RIVETS ETANCHES / ALUMINIUM SEALED RIVET, DOME HEAD  
RIVETTO IN STAGNO / REBITE ESTANQUE CABEÇA ABAULADA

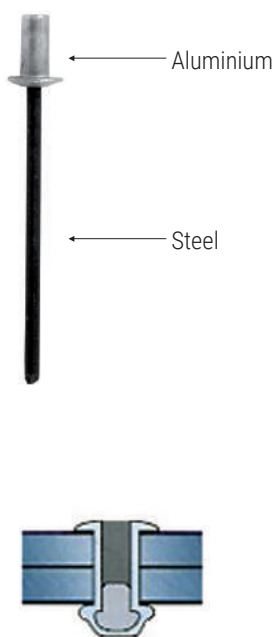

**ESTANCO**

ES El remache estanco es óptimo para procesos de montaje donde es necesario evitar filtraciones de líquidos y vapores.  
FR Le rivet étanche est optimal pour des procédés de montage où il est impératif de prévenir contre toute infiltration de liquides ou vapeurs.  
EN Aluminium sealed dome head rivet is ideal to be used when it is necessary to avoid liquids and fumes filtrations.  
IT Rivetto in stagno, ottimo per le applicazioni in cui è necessario evitare infiltrazioni di liquidi e vapori.  
PT Ideal para ser usado em montagens onde é necessário evitar filtrações de líquidos e vapores.

**Precio x 1000 unidades / Price x 1000 units**

Ref	Ø		
0708 3206	3,2 x 06 mm	1000	<b>41,70</b>
0708 3208	3,2 x 08 mm	1000	<b>53,50</b>
0708 3211	3,2 x 11 mm	1000	<b>65,30</b>
0708 3212	3,2 x 12 mm	1000	<b>84,50</b>
0708 4008	4,0 x 08 mm	1000	<b>56,10</b>
0708 4010	4,0 x 10 mm	1000	<b>79,10</b>
0708 4013	4,0 x 13 mm	1000	<b>86,00</b>
0708 4015	4,0 x 15 mm	500	<b>97,50</b>
0708 4808	4,8 x 08 mm	500	<b>66,30</b>
0708 4810	4,8 x 10 mm	500	<b>79,10</b>
0708 4813	4,8 x 13 mm	500	<b>87,10</b>
0708 4816	4,8 x 16 mm	500	<b>110,00</b>
0708 4818	4,8 x 18 mm	500	<b>143,90</b>
0708 4822	4,8 x 22 mm	500	<b>146,80</b>

REMACHES ALUMINIO RANURADO CABEZA ALOMADA / RIVETS RAINURES / GROOVED BLIND ALUMINIUM RIVET - DOME HEAD  
RIVETTO STRIATO IN ALLUMINIO / REBITES ALUMÍNIO RANHURADOS CABEÇA ABAULADA

RANURADO



- ← Aluminium
- ← Zinc plated stell

ES El remache ranurado es específico para elementos cuyos taladros no sean pasantes. El moleteado le da una mayor eficacia en el agarre.

FR Le rivet rainuré est spécifique pour les assemblages dont les perçages ne sont pas passants. Le rainurage assure une meilleure efficacité de l'accroche.

EN Aluminium grooved dome head rivet is specific for joining elements whose hole is not penetrated completely. Thanks to its grooves, it is more efficient at grasping.

IT Il rivetto striato è specifico per elementi il cui foro non è passante. La striatura permette una maggiore efficacia di tenuta.

PT É específico para unir elementos cujo buraco não é penetrado completamente. Graças às suas ranhuras, é mais eficiente em agarramento.

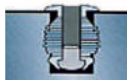

Price x 1000 units

Ref	Ø		
<b>0709 4008</b>	4,0 x 08 mm	1000	<b>35,60</b>
<b>0709 4012</b>	4,0 x 12 mm	1000	<b>46,30</b>
<b>0709 4016</b>	4,0 x 16 mm	500	<b>53,40</b>
<b>0709 4810</b>	4,8 x 10 mm	500	<b>48,20</b>
<b>0709 4814</b>	4,8 x 14 mm	500	<b>64,10</b>
<b>0709 4818</b>	4,8 x 18 mm	500	<b>79,90</b>
<b>0709 4821</b>	4,8 x 21 mm	500	<b>87,00</b>
<b>0709 4826</b>	4,8 x 26 mm	500	<b>98,40</b>

TAPONES PARA REMACHES / PASTILLES CACHE - RIVETS / RIVET CAPS / TAPPI PER RIVETTI / TAMPAS PARA REBITES

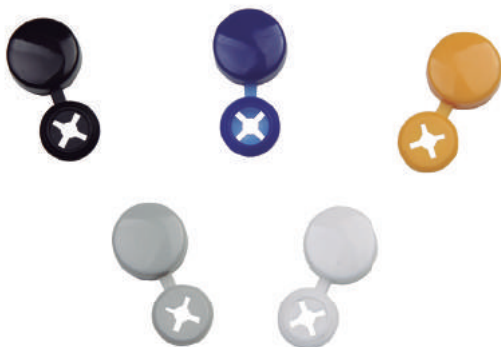

ES Estos tapones están fabricados en diferentes colores, lo que posibilita un acabado estético a la vez que conseguimos un cierre hermético.

FR Ces bouchons sont fabriqués en plusieurs couleurs, rendant possible une finition esthétique et étanche.

EN Rivet caps are made of different colours, what makes possible both an aesthetic finish and hermetic locking.

IT Questi tappi di diverso colore permettono un risultato estetico, avendo allo stesso tempo conseguito una tenuta ermetica.

PT Estas tampas são fabricadas em diferentes cores, que possibilita um acabamento estético e ao mesmo tempo um fecho hermético.

Price x 1000 units

Ref	RAL			
<b>0713 0990</b>	9010		500	<b>83,20</b>
<b>0713 0991</b>	9005		500	<b>83,20</b>
<b>0713 0992</b>	5009		500	<b>83,20</b>
<b>0713 0993</b>	1004		500	<b>83,20</b>
<b>0713 0994</b>	7035		500	<b>83,20</b>



ES Estas tuercas remachables están concebidas para la unión de láminas de acero delgadas, donde se necesita una rosca resistente, debido al poco espesor de dichas láminas y donde se requiera que las piezas a unir estén juntas, pero no sea posible hacer un avellanado. Estas tuercas remachables son ideales para láminas de 0,30 mm a 6,0 mm de espesor. El extremo de las tuercas remachables tiene forma biselada, para facilitar la colocación en el taladro, donde realizaremos el remachado, acelerando su colocación.

FR Ces écrous sont conçus pour la jonction de lames d'acier, très fines, c'est pourquoi il faut un filetage résistant. Application idéale pour des lames de 0,3 à 6,0 mm d'épaisseur. L'extrémité de ces écrous est de forme biseautée, facilitant leur parfaite mise en place dans les trous de perçage sur les pièces à joindre.

EN These rivet nuts are designed to join thin steel sheets, when a resistant thread is needed. They are to be used on sheets of 0,30 mm to 6,0 mm thickness. Its length will depend on the nut and on the thickness of the piece to be riveted. Their bevelled shape makes easy to place them.

IT Questi rivetti filettati sono concepiti per l'unione di lamiera di acciaio quando è necessario ottenere un filetto resistente altrimenti non possibile a causa del limitato spessore delle lamiera. Adatti a lamiera aventi spessore da 0,5 mm a 4,5 mm. La lunghezza del dado in opera è funzione della misura utilizzata e dello spessore delle lamiera chiodate. L'estremità della boccola presenta sezione conica per facilitarne il posizionamento.

PT São concebidas para a união de lâminas finas em aço, onde é necessário uma rosca resistente devido à pouca espessura das lâminas e se require que estejam juntas, mas não é possível fazer um escareador. São ideais para folhas de 0,30 mm a 6,0 mm de espessura. A extremidade tem forma biselada, para facilitar a colocação no berbequim.

**TUERCAS REMACHABLES ACERO CABEZA ANCHA / ECROUS À RIVER ACIER LARGES / STEEL LARGE HEAD OPEN END RIVET NUTS**  
**DADO A RIVETTO IN ACCIAIO, TESTA LARGA / PORCAS DE CRAVAR EM AÇO, CABEÇA GRANDE**

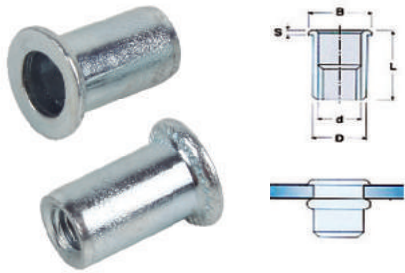

**Precio x 1000 unidades / Price x 1000 units**

Ref	🌀	L	D	B	S	📏	📦	📊
0750 0103	M - 3 mm	9,00 mm	4,90 mm	7,00 mm	0,80 mm	0,30 - 1,80 mm	200	105,40
0750 0104	M - 4 mm	11,00 mm	5,90 mm	9,00 mm	1,00 mm	0,30 - 2,50 mm	200	118,90
0750 0105	M - 5 mm	13,00 mm	6,90 mm	10,00 mm	1,20 mm	0,50 - 3,00 mm	200	148,90
0750 0106	M - 6 mm	14,50 mm	8,90 mm	12,00 mm	1,50 mm	0,50 - 3,20 mm	200	183,30
0750 0108	M - 8 mm	17,50 mm	10,90 mm	15,00 mm	1,50 mm	0,80 - 3,50 mm	200	257,80
0750 0110	M - 10 mm	19,00 mm	11,90 mm	16,00 mm	1,70 mm	1,00 - 3,50 mm	200	326,60
0750 0112	M - 12 mm	22,00 mm	14,90 mm	18,00 mm	2,00 mm	1,00 - 3,50 mm	100	626,40

**TUERCAS REMACHABLES ACERO CABEZA BAJA / ECROUS À RIVER ACIER BAS / STEEL REDUCED HEAD OPEN END RIVET NUTS**  
**DADO A RIVETTO IN ACCIAIO, TESTA BASSA / PORCAS DE CRAVAR EM AÇO, CABEÇA REDUZIDA**

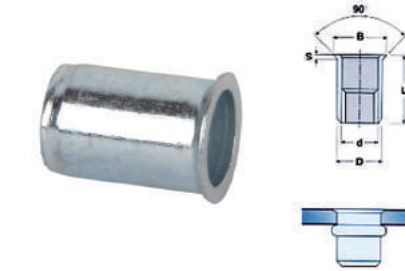

**Precio x 1000 unidades / Price x 1000 units**

Ref	🌀	L	D	B	S	📏	📦	📊
0750 1103	M - 3 mm	8,50 mm	4,90 mm	5,50 mm	0,35 mm	0,50 - 1,50 mm	200	105,40
0750 1104	M - 4 mm	10,00 mm	5,90 mm	6,75 mm	0,50 mm	0,50 - 1,50 mm	200	118,90
0750 1105	M - 5 mm	12,00 mm	6,90 mm	8,00 mm	0,60 mm	0,50 - 2,00 mm	200	133,00
0750 1106	M - 6 mm	13,50 mm	8,90 mm	10,00 mm	0,60 mm	0,50 - 2,00 mm	200	175,20
0750 1108	M - 8 mm	16,50 mm	10,90 mm	12,00 mm	0,60 mm	1,00 - 2,50 mm	200	244,10
0750 1110	M - 10 mm	18,00 mm	12,90 mm	13,50 mm	0,85 mm	1,00 - 2,50 mm	200	302,10

**TUERCAS REMACHABLES ACERO CABEZA ANCHA RANURADA / ECROUS À RIVER ACIER LARGES / STEEL GROOVED LARGE HEAD OPEN END RIVET NUTS**  
**DADO RIVETTO IN ACCIAIO, TESTA LARGA / PORCAS DE CRAVAR EM AÇO, CABEÇA GRANDE RANHURADA**

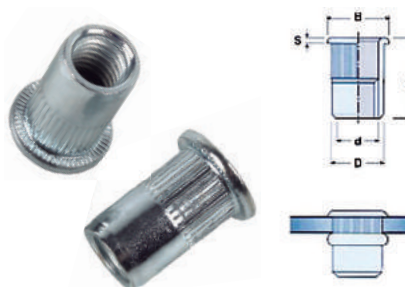

**Precio x 1000 unidades / Price x 1000 units**

Ref	🌀	L	D	B	S	📏	📦	📊
0751 0125	M - 5 mm	14,50 mm	6,90 mm	10,00 mm	1,20 mm	2,0 - 3,5 mm	200	136,10
0751 0126	M - 6 mm	16,00 mm	8,90 mm	12,00 mm	1,50 mm	2,0 - 3,5 mm	200	197,30
0751 0128	M - 8 mm	19,00 mm	10,90 mm	15,00 mm	1,50 mm	2,5 - 4,0 mm	200	281,10
0751 0129	M - 10 mm	21,00 mm	12,90 mm	17,00 mm	1,70 mm	0,5 - 3,0 mm	200	344,60

**TUERCAS REMACHABLES ACERO CABEZA BAJA RANURADA / ECROUS À RIVER ACIER BAS / STEEL GROOVED REDUCED HEAD OPEN END RIVET NUTS**  
**DADO RIVETTO IN ACCIAIO, TESTA BASSA / PORCAS DE CRAVAR EM AÇO, CABEÇA REDUZIDA RANHURADA**

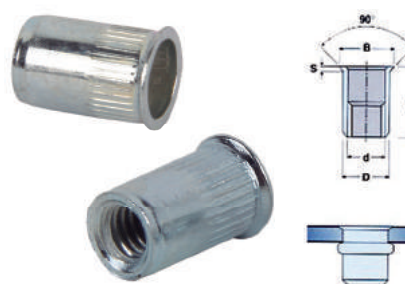

**Precio x 1000 unidades / Price x 1000 units**

Ref	🌀	L	D	B	S	📏	📦	📊
0751 1124	M - 4 mm	10,00 mm	5,90 mm	6,75 mm	0,50 mm	0,5 - 1,5 mm	200	137,30
0751 1125	M - 5 mm	12,00 mm	6,90 mm	8,00 mm	0,60 mm	0,5 - 2,0 mm	200	148,90
0751 1126	M - 6 mm	13,50 mm	8,90 mm	10,00 mm	0,60 mm	0,5 - 2,0 mm	200	171,80
0751 1128	M - 8 mm	16,50 mm	10,90 mm	12,00 mm	0,60 mm	1,0 - 2,5 mm	200	272,00

TUERCAS REMACHABLES ACERO CABEZA ANCHA HEXAGONAL / ECROUS À RIVER HEXAGONAL LEVRE LARGE  
STEEL HEXAGON LARGE HEAD OPEN END RIVET NUTS / DADO RIVETTO IN ACCIAIO, TESTA ESAGONALE LARGA  
PORCAS DE CRAVAR EM AÇO, CABEÇA GRANDE HEXAGONAL

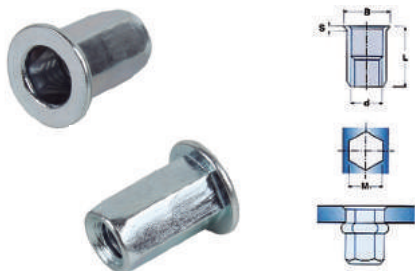

Precio x 1000 unidades / Price x 1000 units

Ref	▬▬▬▬	L	D	B	S	▬▬▬▬	📦	📦
0753 0304	M - 4 mm	11,00 mm	6,00 mm	9,00 mm	1,00 mm	0,50 - 2,00 mm	200	197,40
0753 0305	M - 5 mm	14,00 mm	7,00 mm	10,00 mm	1,00 mm	0,50 - 3,00 mm	200	210,70
0753 0306	M - 6 mm	15,00 mm	9,00 mm	13,00 mm	1,50 mm	0,50 - 3,00 mm	200	223,00
0753 0308	M - 8 mm	18,00 mm	11,00 mm	16,00 mm	1,50 mm	0,50 - 3,00 mm	200	240,40
0753 0310	M - 10 mm	20,00 mm	12,00 mm	18,00 mm	1,70 mm	0,50 - 3,00 mm	200	317,50

TUERCAS REMACHABLES ACERO CABEZA BAJA HEXAGONAL / ECROUS À RIVER HEXAGONAL BAS / STEEL HEXAGON REDUCED HEAD OPEN END RIVET NUTS  
DADO RIVETTO IN ACCIAIO, TESTA ESAGONALE BASSA / PORCAS DE CRAVAR EM AÇO, CABEÇA REDUZIDA HEXAGONAL

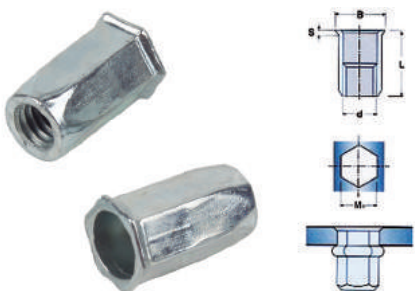

Precio x 1000 unidades / Price x 1000 units

Ref	▬▬▬▬	L	D	B	S	▬▬▬▬	📦	📦
0753 0314	M - 4 mm	11,00 mm	6,00 mm	6,60 mm	0,50 mm	0,50 - 2,00 mm	200	184,30
0753 0315	M - 5 mm	14,00 mm	7,00 mm	8,00 mm	0,60 mm	0,50 - 3,00 mm	200	202,80
0753 0316	M - 6 mm	15,00 mm	9,00 mm	10,00 mm	0,60 mm	0,50 - 3,00 mm	200	234,90
0753 0318	M - 8 mm	18,00 mm	11,00 mm	12,00 mm	0,80 mm	0,50 - 3,00 mm	200	315,10
0753 0320	M - 10 mm	20,00 mm	13,10 mm	14,00 mm	0,80 mm	1,00 - 3,50 mm	200	386,70

TUERCAS REMACHABLES ALUMINIO CABEZA ANCHA "AL MG 3,5" / ECROUS À RIVER ALUMINIUM LÈVRE LARGE "AL MG 3,5"  
ALUMINIUM LARGE HEAD OPEN END RIVET NUTS "AL MG 3,5" / DADO RIVETTO IN ALLUMINIO, TESTA LARGA "AL MG 3,5"  
PORCAS DE CRAVAR EM ALUMÍNIO, CABEÇA GRANDE "AL MG 3,5"

ALUMINIO



Precio x 1000 unidades / Price x 1000 units

Ref	▬▬▬▬	L	D	B	S	▬▬▬▬	📦	📦
0754 0003	M - 3 mm	9,00 mm	4,90 mm	7,00 mm	0,80 mm	0,3 - 1,8 mm	200	144,70
0754 0004	M - 4 mm	11,00 mm	5,90 mm	9,00 mm	1,00 mm	0,3 - 2,5 mm	200	135,00
0754 0005	M - 5 mm	13,00 mm	6,90 mm	10,00 mm	1,20 mm	0,5 - 3,0 mm	200	151,80
0754 0006	M - 6 mm	16,00 mm	8,90 mm	12,00 mm	1,50 mm	2,3 - 4,0 mm	200	183,00
0754 0008	M - 8 mm	17,50 mm	10,90 mm	15,00 mm	1,50 mm	0,8 - 3,5 mm	200	262,00
0754 0010	M - 10 mm	22,00 mm	11,90 mm	16,00 mm	1,70 mm	3,5 - 6,0 mm	200	350,00

TUERCAS REMACHABLES INOXIDABLE CABEZA ANCHA / ECROUS À RIVER ACIER INOX LARGES / STAINLESS STEEL LARGE HEAD OPEN END RIVET NUTS  
DADO RIVETTO IN ACCIAIO INOX, TESTA LARGA / PORCAS DE CRAVAR INOXIDÁVEIS, CABEÇA GRANDE

INOX A-2

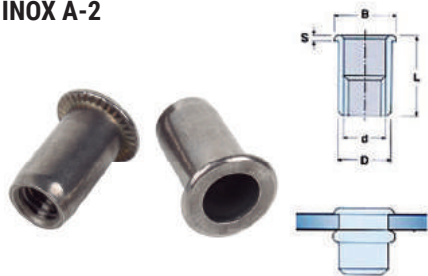

Precio x 1000 unidades / Price x 1000 units

Ref	▬▬▬▬	L	D	B	S	▬▬▬▬	📦	📦
0752 0003	M - 3 mm	8,50 mm	4,90 mm	6,00 mm	0,80 mm	0,3 - 1,0 mm	200	323,40
0752 0004	M - 4 mm	11,00 mm	5,90 mm	8,00 mm	1,00 mm	0,3 - 2,5 mm	200	452,40
0752 0005	M - 5 mm	13,00 mm	6,90 mm	9,00 mm	1,20 mm	0,5 - 3,0 mm	200	657,80
0752 0006	M - 6 mm	15,50 mm	8,90 mm	11,00 mm	1,50 mm	0,5 - 3,5 mm	200	1155,60
0752 0008	M - 8 mm	17,50 mm	10,90 mm	14,00 mm	1,50 mm	0,8 - 3,5 mm	200	1675,60
0752 0010	M - 10 mm	21,00 mm	12,90 mm	17,00 mm	1,70 mm	3,5 - 6,0 mm	200	2561,80

TUERCAS REMACHABLES INOXIDABLE CABEZA BAJA / ECROUS À RIVER ACIER INOX BAS / STAINLESS STEEL REDUCED HEAD OPEN END RIVET NUTS /  
DADO RIVETTO IN ACCIAIO INOX A-2 TESTA BASSA / PORCAS DE CRAVAR INOXIDÁVEIS, CABEÇA REDUZIDA

INOX A-2

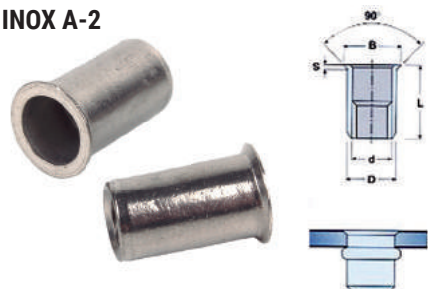

Precio x 1000 unidades / Price x 1000 units

Ref	▬▬▬▬	L	D	B	S	▬▬▬▬	📦	📦
0752 1004	M - 4 mm	10,00 mm	5,90 mm	6,75 mm	0,50 mm	0,5 - 1,5 mm	200	371,80
0752 1005	M - 5 mm	12,00 mm	6,90 mm	8,00 mm	0,60 mm	0,5 - 2,0 mm	200	594,40
0752 1006	M - 6 mm	13,50 mm	8,90 mm	10,00 mm	0,60 mm	0,5 - 2,0 mm	200	945,30
0752 1008	M - 8 mm	16,00 mm	10,90 mm	12,00 mm	0,60 mm	1,0 - 2,5 mm	200	1331,70

ABRAZADERAS DE NYLON PA 6.6 / COLLIERS EN NYLON PA 6.6 / PA 6.6 NYLON CABLE TIES  
FASCETTE IN NYLON PA 6.6 / ABRAÇADEIRAS DE NYLON PA 6.6



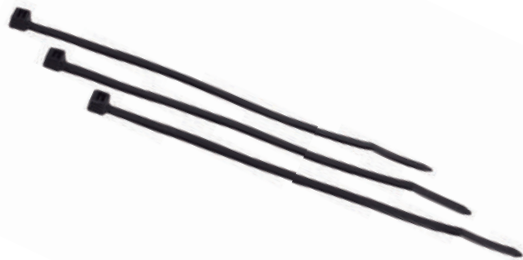

### NYLON PA-6.6



### NYLON PA-6.6



### Precio x 100 unidades / Price x 100 units

Ref				BOX		
0800 2510	■	2,5 mm	100 mm	55.000	100	<b>0,80</b>
0800 2514	■	2,5 mm	140 mm	45.000	100	<b>1,23</b>
0800 2520	■	2,5 mm	200 mm	30.000	100	<b>1,85</b>
0800 3614	■	3,6 mm	140 mm	30.000	100	<b>2,03</b>
0800 3618	■	3,6 mm	180 mm	22.000	100	<b>2,61</b>
0800 3625	■	3,6 mm	250 mm	20.000	100	<b>3,42</b>
0800 3630	■	3,6 mm	300 mm	17.000	100	<b>4,10</b>
0800 3637	■	3,6 mm	370 mm	12.000	100	<b>6,27</b>
0800 4819	■	4,8 mm	190 mm	16.000	100	<b>3,51</b>
0800 4820	■	4,8 mm	200 mm	16.000	100	<b>3,71</b>
0800 4825	■	4,8 mm	250 mm	12.000	100	<b>4,79</b>
0800 4828	■	4,8 mm	280 mm	11.000	100	<b>5,18</b>
0800 4830	■	4,8 mm	300 mm	11.000	100	<b>5,37</b>
0800 4837	■	4,8 mm	370 mm	9.000	100	<b>6,43</b>
0800 4843	■	4,8 mm	430 mm	7.500	100	<b>9,13</b>
0800 4853	■	4,8 mm	530 mm	5.600	100	<b>15,64</b>
0800 7615	■	7,6 mm	150 mm	8.000	100	<b>7,15</b>
0800 7620	■	7,6 mm	200 mm	7.000	100	<b>9,23</b>
0800 7630	■	7,6 mm	300 mm	5.000	100	<b>10,62</b>
0800 7637	■	7,6 mm	370 mm	4.000	100	<b>12,63</b>
0800 7654	■	7,6 mm	540 mm	2.000	100	<b>22,60</b>
0800 9053	■	9,0 mm	530 mm	2.000	100	<b>32,11</b>
0800 9078	■	9,0 mm	780 mm	2.000	100	<b>43,75</b>
0800 9102	■	9,0 mm	1020 mm	1.000	100	<b>59,36</b>
0800 2510N	□	2,5 mm	100 mm	55.000	100	<b>0,80</b>
0800 2514N	□	2,5 mm	140 mm	45.000	100	<b>1,23</b>
0800 2520N	□	2,5 mm	200 mm	30.000	100	<b>1,85</b>
0800 3614N	□	3,6 mm	140 mm	30.000	100	<b>2,03</b>
0800 3618N	□	3,6 mm	180 mm	22.000	100	<b>2,61</b>
0800 3625N	□	3,6 mm	250 mm	20.000	100	<b>3,42</b>
0800 3630N	□	3,6 mm	300 mm	17.000	100	<b>4,10</b>
0800 3637N	□	3,6 mm	370 mm	12.000	100	<b>6,27</b>
0800 4819N	□	4,8 mm	190 mm	16.000	100	<b>3,51</b>
0800 4820N	□	4,8 mm	200 mm	16.000	100	<b>3,71</b>
0800 4825N	□	4,8 mm	250 mm	12.000	100	<b>4,79</b>
0800 4828N	□	4,8 mm	280 mm	11.000	100	<b>5,18</b>
0800 4830N	□	4,8 mm	300 mm	11.000	100	<b>5,37</b>
0800 4837N	□	4,8 mm	370 mm	9.000	100	<b>6,43</b>
0800 4843N	□	4,8 mm	430 mm	7.500	100	<b>9,13</b>
0800 4853N	□	4,8 mm	530 mm	5.600	100	<b>15,64</b>
0800 7615N	□	7,6 mm	150 mm	8.000	100	<b>7,15</b>
0800 7620N	□	7,6 mm	200 mm	7.000	100	<b>9,23</b>
0800 7630N	□	7,6 mm	300 mm	5.000	100	<b>10,62</b>
0800 7637N	□	7,6 mm	370 mm	4.000	100	<b>12,63</b>
0800 7654N	□	7,6 mm	540 mm	2.000	100	<b>22,60</b>
0800 9053N	□	9,0 mm	530 mm	2.000	100	<b>32,11</b>
0800 9078N	□	9,0 mm	780 mm	2.000	100	<b>43,75</b>
0800 9102N	□	9,0 mm	1020 mm	1.000	100	<b>59,36</b>

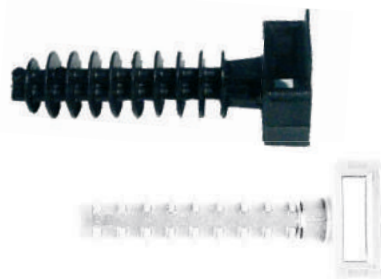
**TACO PARA BRIDAS / CHEVILLES POUR BRIDES / TWIST HOLDER / SUPPORTO FASCETTA / BUCHA PARA ABRAÇADEIRA**

**Precio x 100 unidades / Price x 100 units**

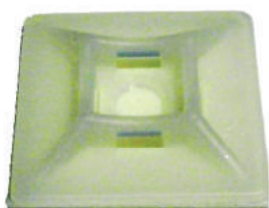
Ref		Ø		BOX		
<b>0800 0003</b>	■	8 mm	35 mm	8.500	100	<b>5,60</b>
<b>0800 0007</b>	■	6 mm	30 mm	8.500	100	<b>5,44</b>
<b>0800 0008</b>	□	8 mm	35 mm	8.500	100	<b>5,60</b>
<b>0800 0009</b>	□	6 mm	30 mm	8.500	100	<b>5,44</b>

**BASE ADHESIVA PARA BRIDAS / BASE ADHESIVE POUR BRIDES / ADHESIVE BACKED TIE MOUNTS / BASE ADESIVA PER FASCETTE / BASE ADESIVA**

**Precio x 100 unidades / Price x 100 units**

Ref		M	BOX		
<b>0800 0006</b>	3,2 mm	12x12 mm	55.000	100	<b>4,05</b>
<b>0800 0001</b>	3,6 mm	19x19 mm	24.000	100	<b>4,95</b>
<b>0800 0002</b>	4,8 mm	25x25 mm	9.000	100	<b>7,89</b>

**BASE ATORNILLABLE PARA BRIDAS / BASE VISSABLE POUR BRIDES / SADDLE TIE MOUNTS / BASE AVVITABILE PER FASCETTE / BASE APARAFUSADA**

**Precio x 100 unidades / Price x 100 units**

Ref	Ø Máx		BOX		
<b>0800 0004</b>	5 mm	3 mm	30.000	100	<b>6,30</b>
<b>0800 0005</b>	9 mm	6 mm	12.000	100	<b>6,48</b>

**ABRAZADERAS METÁLICAS / COLLIERS METALLIQUES / HOSE CLAMPS / FASCETTE METALLICHE / ABRAÇADEIRAS METÁLICAS**

ES Abrazaderas Metálicas: Contienen enganche de rosca incorporado. No contienen cantos ni rebabas. Fleje en acero inoxidable y tornillo en acero.

FR Colliers métalliques: Cerclage de serrage avec filetage incorporé. Cercle en acier inoxydable et vis en acier.

EN Hose Clamps with built-in thread connection. Rounded edges. Stainless Steel band and steel screw.

IT Fascette metalliche. Con aggancio filetto incorporato, senza spigoli. Bande di acciaio INOX e vite acciaio.

PT Abraçadeiras Metálicas: Contêm rosca de conexão incorporada. Bordas arredondadas. Fecho de aço inoxidável e parafuso INOX

BANDA 9 mm / BANDE 9 mm / BAND WIDTH 9 mm  
NASTRO 9 mm / LARGURA BANDA 9 mm

BANDA 12 mm / BANDE 12 mm / BAND WIDTH 12 mm  
NASTRO 12 mm / LARGURA BANDA 12 mm



Ref	Ø			Ref	Ø		
<b>0801 0812</b>	8 - 12 mm	100	<b>0,286</b>	<b>0802 2032</b>	20 - 32 mm	100	<b>0,395</b>
<b>0801 1016</b>	10 - 16 mm	100	<b>0,291</b>	<b>0802 2540</b>	25 - 40 mm	100	<b>0,484</b>
<b>0801 1220</b>	12 - 20 mm	100	<b>0,307</b>	<b>0802 3045</b>	30 - 45 mm	100	<b>0,530</b>
<b>0801 1625</b>	16 - 25 mm	100	<b>0,317</b>	<b>0802 3250</b>	32 - 50 mm	100	<b>0,634</b>
<b>0801 2032</b>	20 - 32 mm	100	<b>0,333</b>	<b>0802 4060</b>	40 - 60 mm	100	<b>0,676</b>
<b>0801 2540</b>	25 - 40 mm	100	<b>0,338</b>	<b>0802 5070</b>	50 - 70 mm	50	<b>0,754</b>
<b>0801 3045</b>	30 - 45 mm	100	<b>0,348</b>	<b>0802 6080</b>	60 - 80 mm	50	<b>0,764</b>
<b>0801 3250</b>	32 - 50 mm	100	<b>0,369</b>	<b>0802 7090</b>	70 - 90 mm	50	<b>0,801</b>
<b>0801 4060</b>	40 - 60 mm	100	<b>0,406</b>	<b>0802 80100</b>	80 - 100 mm	50	<b>0,884</b>
<b>0801 5070</b>	50 - 70 mm	100	<b>0,484</b>	<b>0802 10120</b>	100 - 120 mm	50	<b>0,988</b>
<b>0801 6080</b>	60 - 80 mm	50	<b>0,556</b>	<b>0802 11130</b>	110 - 130 mm	50	<b>1,082</b>
<b>0801 7090</b>	70 - 90 mm	50	<b>0,603</b>	<b>0802 12140</b>	120 - 140 mm	50	<b>1,154</b>
				<b>0802 14160</b>	140 - 160 mm	25	<b>1,243</b>



ABRAZADERAS METÁLICAS INOXIDABLES A-2 / COLLIERS METALLIQUES INOX A-2 / STAINLESS STEEL A-2 HOSE CLAMPS  
FASCETTE METALLICHE INOX A-2 / ABRAÇADEIRAS METÁLICAS INOXIDÁVEIS A-2



**INOX A-2**

ES Contienen enganche de rosca incorporado. No contienen cantos ni rebabas. Fleje de acero inoxidable y tornillo de acero INOX.  
FR Cerclage de serrage avec filetage incorporé. Cercle en acier inoxydable et vis en acier INOX.  
EN With built in thread connection. Rounded edges. Stainless Steel band and stainless steel screw.  
IT Con aggancio filetto incorporato, senza spigoli. Bande di acciaio INOX e vite acciaio INOX.  
PT Contém: rosca de conexão incorporada. Bordas arredondadas. Fecho de aço inoxidável e parafuso INOX.



BANDA 9 mm / BANDE 9 mm / BAND WIDTH 9 mm  
NASTRO 9 mm / LARGURA BANDA 9 mm

BANDA 12 mm / BANDE 12 mm / BAND WIDTH 12 mm  
NASTRO 12 mm / LARGURA BANDA 12 mm

Ref	Ø			Ref	Ø		
<b>0807 0812</b>	8 - 12 mm	100	<b>0,90</b>	<b>0808 2032</b>	20 - 32 mm	100	<b>1,39</b>
<b>0807 1016</b>	10 - 16 mm	100	<b>0,95</b>	<b>0808 2540</b>	25 - 40 mm	100	<b>1,51</b>
<b>0807 1220</b>	12 - 20 mm	100	<b>0,97</b>	<b>0808 3045</b>	30 - 45 mm	100	<b>1,58</b>
<b>0807 1625</b>	16 - 25 mm	100	<b>1,03</b>	<b>0808 3250</b>	32 - 50 mm	100	<b>1,63</b>
<b>0807 2032</b>	20 - 32 mm	100	<b>1,07</b>	<b>0808 4060</b>	40 - 60 mm	100	<b>1,76</b>
<b>0807 2540</b>	25 - 40 mm	100	<b>1,10</b>	<b>0808 5070</b>	50 - 70 mm	50	<b>1,82</b>
<b>0807 3045</b>	30 - 45 mm	100	<b>1,14</b>	<b>0808 6080</b>	60 - 80 mm	50	<b>1,97</b>
<b>0807 3250</b>	32 - 50 mm	100	<b>1,19</b>	<b>0808 7090</b>	70 - 90 mm	50	<b>2,04</b>
<b>0807 4060</b>	40 - 60 mm	100	<b>1,22</b>	<b>0808 80100</b>	80 - 100 mm	50	<b>2,19</b>
<b>0807 5070</b>	50 - 70 mm	100	<b>1,54</b>	<b>0808 11130</b>	110 - 130 mm	50	<b>2,43</b>
<b>0807 6080</b>	60 - 80 mm	50	<b>1,68</b>	<b>0808 12140</b>	120 - 140 mm	50	<b>2,65</b>
<b>0807 7090</b>	70 - 90 mm	50	<b>1,93</b>	<b>0808 14160</b>	140 - 160 mm	25	<b>2,96</b>

ABRAZADERA CONTINUA PARA CORTAR / COLLIERS A LA COUPE / CONTINUOUS HOSE CLAMPS  
FASCETTE SENZA FINE CON TESTE / ABRAÇADEIRAS CONTÍNUAS P / CORTAR



**INOX W4-304**

Ref	Ø	↔		
<b>0805 3003</b>	9 mm	3 m	8	<b>14,50</b>
<b>0805 3030</b>	9 mm	30 m	1	<b>48,30</b>

CIERRES PARA ABRAZADERAS CONTINUAS / DISPOSITIF DE SERRAGE POUR COLLIERS A LA COUPE  
LOCKS FOR CONTINUOUS HOSE CLAMPS / SERRATURE PER FASCETTE  
TRAVAS PARA ABRAÇADEIRAS CONTÍNUAS



Ref	↔		
<b>0805 3039</b>	9 mm	10	<b>1,26</b>



ABRAZADERAS METÁLICAS STANDARD / COLLIERS MÉTALLIQUES STANDARDS / METALLIC HOSE CLAMPS STANDARD  
FASCETTE METALLICHE STANDARD / ABRAÇADEIRA METÁLICAS STANDARD



**GALVANIZADO  
MINI-CLAMP**

Ref	Ø			Ref	Ø		
0805 0608	6 - 8 mm	200	0,271	0805 2022	20 - 22 mm	100	0,445
0805 0709	7 - 9 mm	200	0,284	0805 2123	21 - 23 mm	50	0,452
0805 0810	8 - 10 mm	200	0,284	0805 2224	22 - 24 mm	50	0,465
0805 0911	9 - 11 mm	200	0,286	0805 2325	23 - 25 mm	50	0,465
0505 1012	10 - 12 mm	200	0,297	0805 2426	24 - 26 mm	50	0,478
0805 1113	11 - 13 mm	200	0,297	0805 2527	25 - 27 mm	50	0,478
0805 1214	12 - 14 mm	200	0,297	0805 2628	26 - 28 mm	50	0,478
0805 1315	13 - 15 mm	200	0,392	0805 2729	27 - 29 mm	50	0,491
0805 1416	14 - 16 mm	100	0,310	0805 2830	28 - 30 mm	50	0,491
0805 1517	15 - 17 mm	100	0,310	0805 2931	29 - 31 mm	50	0,504
0805 1618	16 - 18 mm	100	0,413	0805 3032	30 - 32 mm	50	0,504
0805 1719	17 - 19 mm	100	0,426	0805 3133	31 - 33 mm	50	0,504
0805 1820	18 - 20 mm	100	0,426	0805 3234	32 - 34 mm	50	0,516
0805 1921	19 - 21 mm	100	0,435				

EXPOSITOR ABRAZADERAS METÁLICAS / PRÉSENTOIR COLLIERS MÉTALLIQUES / HOSE CLAMPS WALL DISPENSER  
ESPOSITORE FASCETTE METALLICHE / EXPOSITOR PARA ABRAÇADEIRAS METÁLICAS

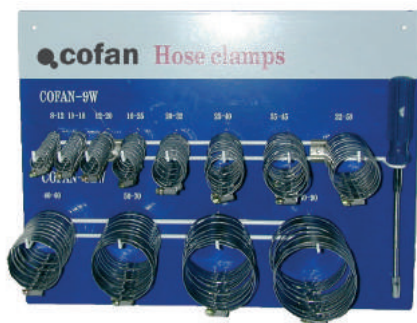

ES Expositor abrazaderas con 120 abrazaderas + destornillador flexible. Fleje 9 mm y 12 mm.  
FR Présentoir avec 120 colliers métalliques + un tournevis flexible. Bande 9 mm à 12 mm.  
EN Wall dispenser with 120 hose clamps + flex driver. Band width 9 mm and 12 mm.  
IT Espositore con 120 fascette + cacciavite flessibile. Fascia da 9 mm e 12 mm.  
PT Expositor com 120 abraçadeiras + chave de fendas flexível. Largura da banda 9 mm e 12 mm.

Ref	M mínima	M máxima	↔		
0802 0899	8-12 mm	70-90 mm	9-12 mm	1	95,37
0802 7999	VACÍO / ONLY DISPLAY			1	33,28

Ref		↔	
0801 0812	8-12	9 mm	10
0801 1016	10-16	9 mm	10
0801 1220	12-20	9 mm	10
0801 1625	16-25	9 mm	10
0801 2032	20-32	9 mm	10
0801 2540	25-40	9 mm	10
0801 3045	30-45	9 mm	10
0801 3250	32-50	9 mm	10
0802 4060	40-60	12 mm	10
0802 5070	50-70	12 mm	10
0802 6080	60-80	12 mm	10
0802 7090	70-90	12 mm	10
0802 7999	Expositor		1
0951 0001	Flex driver SW-7		1

EXPOSITOR ABRAZADERAS VACÍO PARA 9MM / PRESENTOIR VIDE POUR COLLIERS 9MM / EMPTY DISPLAY STAND FOR 9MM HOSE CLAMPS  
ESPOSITORE VAUOTO PER FASCETTE 9MM / EXPOSITOR VAZIO P/ ABRAÇADEIRAS 9MM

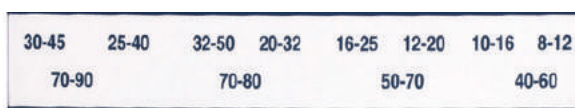
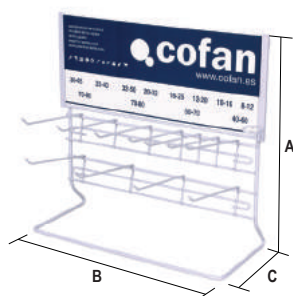

Ref	A	B	C		
0801 7999	340 mm	370 mm	200 mm	1	30,16

DESTORNILLADOR FLEXIBLE PARA ABRAZADERAS SW 7 / TOURNEVIS FLEXIBLE POUR COLLIERS SW7 / FLEX DRIVER FOR HOSE CLAMPS SW 7  
CACCIAVITE FLESSIBILE SW7 / CHAVE DE FENDAS FLEXÍVEL PARA ABRAÇADEIRAS SW7



Ref	M		
<b>0951 0001</b>	SW 7	1	<b>7,80</b>

ABRAZADERAS SIN-FIN ABIERTAS / COLLIER METALLIQUE OUVERT / OPEN HOSE CLAMP  
FASCETTE METALLICHE SENZA FINE, APERTE / ABRAÇADEIRAS ABERTAS



Ref	M		
<b>0805 0711</b>	8 - 12 mm	100	<b>1,75</b>
<b>0805 1119</b>	12 - 20 mm	100	<b>1,79</b>

ABRAZADERAS METÁLICAS SÚPER GRAN PRESIÓN / COLLIERS METALLIQUES HAUTE PRESSION / SUPER HOSE CLAMPS HIGH PRESSURE  
FASCETTE METALLICHE GRANDE PRESSIONE / ABRAÇADEIRAS METÁLICAS SUPER ALTA PRESSÃO



ES Abrazadera Súper Gran Presión. Material: Acero. Tornillo: Clase 8.8. Protección: Zincado.  
FR Collier métallique très haute pression. Matériel: Acier. Vis: Classe 8.8. Protection: Zingué.  
EN Super Hose Clamps High Pressure. Material: Steel. Screw: Class 8.8. Coating: Zinc.  
IT Fascette Metalliche Grande Pressione. Materiale: Acciaio. Vite: Classe 8.8. Protezione: Zinco.  
PT Abraçadeira Super Alta Pressão. Material: Aço. Parafuso: Classe 8.8. Proteção: Zincado.

Ref	∅	↔		
<b>0803 1719</b>	17 - 19 mm	18 mm	25	<b>1,07</b>
<b>0803 2022</b>	20 - 22 mm	18 mm	25	<b>1,04</b>
<b>0803 2325</b>	23 - 25 mm	18 mm	25	<b>1,06</b>
<b>0803 2628</b>	26 - 28 mm	18 mm	25	<b>1,06</b>
<b>0803 2931</b>	29 - 31 mm	20 mm	25	<b>1,23</b>
<b>0803 3235</b>	32 - 35 mm	20 mm	25	<b>1,25</b>
<b>0803 3639</b>	36 - 39 mm	20 mm	25	<b>1,26</b>
<b>0803 4043</b>	40 - 43 mm	20 mm	25	<b>1,28</b>
<b>0803 4447</b>	44 - 47 mm	22 mm	25	<b>1,41</b>
<b>0803 4851</b>	48 - 51 mm	22 mm	25	<b>1,65</b>
<b>0803 5255</b>	52 - 55 mm	22 mm	25	<b>1,75</b>
<b>0803 5659</b>	56 - 59 mm	22 mm	25	<b>1,76</b>
<b>0803 6063</b>	60 - 63 mm	22 mm	25	<b>1,85</b>
<b>0803 6467</b>	64 - 67 mm	22 mm	25	<b>2,38</b>
<b>0803 6873</b>	68 - 73 mm	24 mm	25	<b>2,59</b>
<b>0803 7479</b>	74 - 79 mm	24 mm	25	<b>2,85</b>
<b>0803 8085</b>	80 - 85 mm	24 mm	25	<b>2,92</b>

Ref	∅	↔		
<b>0803 8691</b>	86 - 91 mm	24 mm	25	<b>2,98</b>
<b>0803 9297</b>	92 - 97 mm	24 mm	25	<b>3,06</b>
<b>0803 98103</b>	98 - 103 mm	24 mm	25	<b>3,13</b>
<b>0803 104112</b>	104 - 112 mm	24 mm	10	<b>3,55</b>
<b>0803 113121</b>	113 - 121 mm	24 mm	10	<b>3,63</b>
<b>0803 122130</b>	122 - 130 mm	24 mm	10	<b>3,72</b>
<b>0803 131139</b>	131 - 139 mm	26 mm	10	<b>4,90</b>
<b>0803 140148</b>	140 - 148 mm	26 mm	10	<b>4,99</b>
<b>0803 149161</b>	149 - 161 mm	26 mm	10	<b>5,27</b>
<b>0803 162174</b>	162 - 174 mm	26 mm	5	<b>5,86</b>
<b>0803 175187</b>	175 - 187 mm	26 mm	5	<b>6,48</b>
<b>0803 188200</b>	188 - 200 mm	26 mm	5	<b>6,64</b>
<b>0803 201213</b>	201 - 213 mm	26 mm	5	<b>6,77</b>
<b>0803 214226</b>	214 - 226 mm	26 mm	5	<b>6,99</b>
<b>0803 227239</b>	227 - 239 mm	26 mm	5	<b>7,25</b>
<b>0803 240252</b>	240 - 252 mm	26 mm	5	<b>7,38</b>

ABRAZADERAS METÁLICAS SÚPER INOX A-2 / COLLIERS METALLIQUES HAUTE PRESSION INOX A-2  
 SUPER HOSE CLAMPS HIGH PRESSURE STAINLESS STEEL A-2 / FASCETTE METALLICHE GRANDE PRESSIONE INOX A-2  
 ABRAÇADEIRAS METÁLICAS SUPER INOX A-2

**INOX A-2**

ES Abrazadera Súper Gran Presión. Material: Acero Inoxidable (AISI 304). Tornillo: INOX A-2.  
 FR Collier Métallique Très Haute Pression. Matériel: acier inoxydable (AISI 304). Vis: INOX A-2.  
 EN Super Hose Clamps High Pressure. Material: Stainless Steel (AISI 304). Screw: INOX A-2.  
 IT Fascette Metalliche Grande Pressione. Materiale: Acciaio inossidabile (AISI 304). Vite: INOX A-2.  
 PT Abraçadeira Super Alta Pressão. Material: Aço Inoxidável (AISI 304). Parafuso: INOX A-2.

Ref	Ø	↔	📦	📊
0809 1719	17 - 19 mm	18 mm	25	2,76
0809 2022	20 - 22 mm	18 mm	25	2,76
0809 2325	23 - 25 mm	18 mm	25	2,80
0809 2628	26 - 28 mm	18 mm	25	2,96
0809 2931	29 - 31 mm	20 mm	25	3,37
0809 3235	32 - 35 mm	20 mm	25	3,41
0809 3639	36 - 39 mm	20 mm	25	3,44
0809 4043	40 - 43 mm	20 mm	25	3,50
0809 4447	44 - 47 mm	22 mm	25	4,09
0809 4851	48 - 51 mm	22 mm	25	4,15
0809 5255	52 - 55 mm	22 mm	25	4,21
0809 5659	56 - 59 mm	22 mm	25	4,37
0809 6063	60 - 63 mm	22 mm	25	4,45
0809 6467	64 - 67 mm	22 mm	25	5,97
0809 6873	68 - 73 mm	24 mm	20	6,39
0809 7479	74 - 79 mm	24 mm	25	6,48
0809 8085	80 - 85 mm	24 mm	25	6,62
0809 8691	86 - 91 mm	24 mm	25	6,71
0809 9297	92 - 97 mm	24 mm	25	6,86
0809 98103	98 - 103 mm	24 mm	25	6,97
0809 104112	104 - 112 mm	24 mm	10	7,52
0809 113121	113 - 121 mm	24 mm	10	7,65
0809 122130	122 - 130 mm	24 mm	10	7,80
0809 131139	131 - 139 mm	26 mm	10	11,02
0809 140148	140 - 148 mm	26 mm	10	11,79
0809 149161	149 - 161 mm	26 mm	10	12,62
0809 162174	162 - 174 mm	26 mm	5	12,85
0809 175187	175 - 187 mm	26 mm	5	13,60
0809 188200	188 - 200 mm	26 mm	5	13,81
0809 201213	201 - 213 mm	26 mm	5	13,87
0809 214226	214 - 226 mm	26 mm	5	14,26
0809 227239	227 - 239 mm	26 mm	5	14,62
0809 240252	240 - 252 mm	26 mm	5	14,88

ABRAZADERAS DE 2 OREJAS / COLLIER METALLIQUE 2 OREILLES / DOUBLE EAR HOSE CLAMPS  
FASCETTE METALLICHE A 2 ORECCHIE / ABRAÇADEIRA DE 2 ORELHAS



Ref	Ø		
0804 0305	3 - 5 mm	500	0,237
0804 0507	5 - 7 mm	500	0,196
0804 0709	7 - 9 mm	500	0,203
0804 0911	9 - 11 mm	500	0,229
0 804 1113	11 - 13 mm	250	0,229
0804 1315	13 - 15 mm	250	0,255
0804 1417	14 - 17 mm	250	0,308
0804 1518	15 - 18 mm	250	0,317
0804 1720	17 - 20 mm	250	0,326
0804 1821	18 - 21 mm	250	0,335
0804 2023	20 - 23 mm	250	0,467
0804 2225	22 - 25 mm	100	0,484
0804 2327	23 - 27 mm	100	0,502
0804 2528	25 - 28 mm	100	0,546
0804 2831	28 - 31 mm	50	0,590
0804 3134	31 - 34 mm	50	0,599
0804 3437	34 - 37 mm	50	0,669
0804 3740	37 - 40 mm	50	0,837
0804 4043	40 - 43 mm	25	0,837
0804 4346	43 - 46 mm	25	1,127

MALETÍN ABRAZADERAS METÁLICAS DOS OREJAS (CONTENIDO 350 ABRAZADERAS) / MALETTE COLLIERS MÉTALLIQUES DEUX OREILLES (CONTENU 350 COLLIERS)  
DOUBLE EAR HOSE CLAMPS CASE (350 UNITS) / VALIGETTA CONTENENTE FASCETTE METALLICHE A DOPPIA ORECCHIA (CONTIENE 350 FASCETTE)  
CAIXA ABRAÇADEIRAS METÁLICAS DUAS ORELHAS (CONTEÚSO 350 ABRAÇADEIRAS)



Ref	Ø		
0804 0507	5-7		50
0804 0709	7-9		50
0804 0911	9-11		50
0804 1113	11-13		25
0804 1315	13-15		25
0804 1417	14-17		25
0804 1518	15-18		25
0804 1720	17-20		25
0804 1821	18-21		25
0804 2023	20-23		25
0804 2225	22-25		10
0804 2528	25-28		10
0804 3134	31-34		5
0940 0223	Maletín		1

Ref			
0401 0804	350 pcs	1	163,63

ABRAZADERA METÁLICA M-8 PARA TUBO / COLLIERS MÉTALLIQUE M-8 POUR TUBE / METALLIC HOSE CLAMPS M-8  
FASCETTA METALLICA M-8 PER TUBO / ABRAÇADEIRA METÁLICA M-8 PARA TUBO



Ref	Ø		
1800 6299	50 mm	25	1,429
1800 6300	63 mm	25	1,470
1800 6301	75 mm	25	1,500
1800 6302	90 mm	25	1,620
1800 6303	110 mm	25	1,771
1800 6304	125 mm	10	1,874
1800 6305	160 mm	10	2,401
1800 6306	200 mm	10	2,805
1800 6307	250 mm	5	3,484

ABRAZADERA METÁLICA M-6 PARA TUBO / COLLIERS MÉTALLIQUE M-6 POUR TUBE / METALLIC HOSE CLAMPS M-6  
FASCETTA METALLICA M-6 PER TUBO / ABRAÇADEIRA METÁLICA M-6 PARA TUBO



Ref	Ø			Ref	Ø		
<b>1800 6101</b>	6 mm	100	<b>0,220</b>	<b>1800 6112</b>	26 mm	50	<b>0,231</b>
<b>1800 6102</b>	8 mm	100	<b>0,179</b>	<b>1800 6113</b>	28 mm	50	<b>0,240</b>
<b>1800 6103</b>	10 mm	100	<b>0,182</b>	<b>1800 6114</b>	32 mm	50	<b>0,267</b>
<b>1800 6104</b>	12 mm	100	<b>0,190</b>	<b>1800 6115</b>	35 mm	50	<b>0,306</b>
<b>1800 6105</b>	14 mm	100	<b>0,196</b>	<b>1800 6116</b>	40 mm	25	<b>0,330</b>
<b>1800 6106</b>	15 mm	100	<b>0,197</b>	<b>1800 6117</b>	42 mm	25	<b>0,355</b>
<b>1800 6107</b>	16 mm	100	<b>0,203</b>	<b>1800 6118</b>	47 mm	25	<b>0,392</b>
<b>1800 6108</b>	18 mm	100	<b>0,204</b>	<b>1800 6119</b>	50 mm	25	<b>0,410</b>
<b>1800 6109</b>	20 mm	100	<b>0,210</b>	<b>1800 6120</b>	54 mm	25	<b>0,431</b>
<b>1800 6110</b>	22 mm	100	<b>0,216</b>	<b>1800 6121</b>	60 mm	25	<b>0,471</b>
<b>1800 6111</b>	24 mm	50	<b>0,226</b>	<b>1800 6122</b>	63 mm	25	<b>0,484</b>

ABRAZADERA ISOFÓNICA M-6 / COLLIERS ISOPHONIQUE M-6 / ISOPHONIC PIPE CLAMPS M-6  
COLLARI ISOFONICI M-6 / ABRAÇADEIRAS ISOPHONIC M-6



Ref	Ø		
<b>1800 6201</b>	12 mm	100	<b>0,302</b>
<b>1800 6202</b>	15 mm	100	<b>0,322</b>
<b>1800 6203</b>	18 mm	50	<b>0,345</b>
<b>1800 6204</b>	22 mm	50	<b>0,381</b>
<b>1800 6205</b>	26 mm	50	<b>0,427</b>
<b>1800 6206</b>	28 mm	25	<b>0,450</b>
<b>1800 6207</b>	35 mm	25	<b>0,534</b>
<b>1800 6208</b>	42 mm	25	<b>0,619</b>
<b>1800 6209</b>	54 mm	10	<b>0,755</b>
<b>1800 6210</b>	60 mm	10	<b>0,813</b>

**TIRAFONDOS / TIRE-FONDS / LAG SCREWS / TIRAFONDI / PARAFUSOS**

TIRAFONDOS CON ROSCA / TIRE-FONDS / HEXAGON HEAD SCREWS WITH THREAD  
TIRAFONDI A DOPPIO FILETTO / PARAFUSOS COM ROSCA



Ref	M		
<b>1800 6401</b>	M-6x30 mm	100	<b>0,060</b>
<b>1800 6402</b>	M-6x50 mm	100	<b>0,081</b>
<b>1800 6403</b>	M-8x40 mm	100	<b>0,104</b>

GRAPA CON PIE FORMA "F" / SERRE PIED FORME "F" / METALLIC PIPE CLAMPS, "F" SHAPE  
FASCETTA AD ARCO / ABRAÇADEIRAS METÁLICAS FORMA "F"



Ref	M			Ref	M		
<b>1800 6001</b>	6 mm	100	<b>0,071</b>	<b>1800 6010</b>	22 mm	100	<b>0,158</b>
<b>1800 6002</b>	8 mm	100	<b>0,074</b>	<b>1800 6011</b>	24 mm	100	<b>0,165</b>
<b>1800 6003</b>	10 mm	100	<b>0,078</b>	<b>1800 6012</b>	26 mm	50	<b>0,178</b>
<b>1800 6004</b>	12 mm	100	<b>0,087</b>	<b>1800 6013</b>	28 mm	50	<b>0,204</b>
<b>1800 6005</b>	14 mm	100	<b>0,106</b>	<b>1800 6014</b>	32 mm	50	<b>0,343</b>
<b>1800 6007</b>	16 mm	100	<b>0,111</b>	<b>1800 6015</b>	40 mm	50	<b>0,411</b>
<b>1800 6008</b>	18 mm	100	<b>0,114</b>	<b>1800 6016</b>	42 mm	25	<b>0,425</b>
<b>1800 6009</b>	20 mm	100	<b>0,143</b>	<b>1800 6017</b>	50 mm	25	<b>0,468</b>



ANILLOS SEEGER DIN-471 PARA EJES EXTERIORES / ANNEAUX SEEGER DIN-471 POUR AXES EXTÉRIEUR / DIN-471 SEEGER RINGS EXTERIOR SPINDLE  
 ANELLO SEEGER DIN-471 PER ALBERO / ANEIS SEEGER DIN 471 PARA EIXOS EXTERIORES

Precio x 100 unidades / Price x 100 units



Ref	EJE			Ref	EJE		
0471 A003	3x0,4 mm	250	4,16	0471 A046	45x1,75 mm	100	50,73
0471 A004	4x0,4 mm	250	5,20	0471 A047	45x1,75 mm	100	80,08
0471 A005	5x0,6 mm	250	3,12	0471 A048	48x1,75 mm	100	54,08
0471 A006	6x0,7 mm	250	3,12	0471 A050	50x2 mm	50	61,36
0471 A007	7x0,8 mm	250	4,16	0471 A052	52x2 mm	50	63,44
0471 A008	8x0,8 mm	250	3,12	0471 A055	55x2 mm	50	72,80
0471 A009	9x1 mm	250	4,16	0471 A056	56x2 mm	50	133,12
0471 A010	10x1 mm	250	4,16	0471 A058	58x2 mm	50	74,88
0471 A011	11x1 mm	250	6,24	0471 A060	60x2 mm	50	80,08
0471 A012	12x1 mm	250	4,16	0471 A062	62x2 mm	50	84,24
0471 A013	13x1 mm	250	5,20	0471 A065	65x2,5 mm	25	126,88
0471 A014	14x1 mm	250	5,20	0471 A068	68x2,5 mm	25	125,84
0471 A015	15x1 mm	250	5,20	0471 A070	70x2,5 mm	25	135,20
0471 A016	16x1 mm	250	6,24	0471 A072	72x2,5 mm	25	147,68
0471 A017	17x1 mm	250	7,28	0471 A075	75x2,5 mm	25	156,00
0471 A018	18x1,2 mm	250	8,32	0471 A078	78x2,5 mm	25	157,04
0471 A019	19x1,2 mm	250	9,36	0471 A080	80x2,5 mm	25	163,28
0471 A020	20x1,2 mm	250	10,40	0471 A082	82x2,5 mm	10	173,68
0471 A021	21x1,2 mm	250	11,00	0471 A085	85x3 mm	10	222,56
0471 A022	22x1,2 mm	250	13,52	0471 A090	90x3 mm	10	248,56
0471 A023	23x1,2 mm	250	19,00	0471 A095	95x3 mm	10	264,16
0471 A024	24x1,2 mm	250	14,56	0471 A100	100x3 mm	10	298,48
0471 A025	25x1,2 mm	250	15,60	0471 A105	105x4 mm	5	439,92
0471 A026	26x1,2 mm	250	17,68	0471 A110	110x4 mm	5	486,72
0471 A027	27x1,2 mm	250	18,09	0471 A115	115x4 mm	5	523,12
0471 A028	28x1,5 mm	250	19,76	0471 A120	120x4 mm	5	556,40
0471 A029	29x1,5 mm	250	24,96	0471 A125	125x4 mm	5	643,76
0471 A030	30x1,5 mm	250	24,96	0471 A130	130x4 mm	5	696,80
0471 A031	31x1,5 mm	100	30,16	0471 A135	135x4 mm	5	728,00
0471 A032	32x1,5 mm	100	28,08	0471 A140	140x4 mm	5	762,32
0471 A033	33x1,5 mm	100	28,83	0471 A145	145x4 mm	5	820,56
0471 A034	34x1,5 mm	100	28,08	0471 A150	150x4 mm	5	873,60
0471 A035	35x1,5 mm	100	30,16	0471 A160	160x4 mm	5	1272,96
0471 A036	36x1,75 mm	100	36,40	0471 A170	170x4 mm	5	1761,76
0471 A037	37x1,75 mm	100	41,18	0471 A175	175x4 mm	5	1941,68
0471 A038	38x1,75 mm	100	38,48	0471 A180	180x4 mm	5	2040,48
0471 A040	40x1,75 mm	100	41,60	0471 A185	185x4 mm	5	2141,36
0471 A042	42x1,75 mm	100	48,88	0471 A190	190x4 mm	5	2221,44
0471 A044	44x1,75 mm	100	48,88	0471 A200	200x4 mm	5	2638,48
0471 A045	45x1,75 mm	100	49,92				

MALETÍN SURTIDO 1900 UND - DIN 471 / VALISE ASSORTIMENT 1900 UNITES - DIN 471 / ASSORTED CASE 1900 PCS - DIN 471  
 ASSORTIMENTO 1900 PEZZI - DIN 471 / CAIXA SORTIDA 1900 PÇS - DIN 471



Ref			
0471 9999	1900 uds	1	302,40

ANILLOS SEEGER DIN-472 PARA AGUJEROS INTERIORES / ANNEAUX SEEGER DIN-472 PARA AXES INTÉRIEURS  
 DIN-472 SEEGER RINGS INTERIOR SPINDLE / ANELLO SEEGER DIN-472 PER MOZZO  
 ANEIS SEEGER DIN-472 PARA FUIROS INTERIORES

Precio x 100 unidades / Price x 100 units



Ref	EJE			Ref	EJE		
0472 J008	8x0,8 mm	250	4,16	0472 J055	55x2 mm	50	56,16
0472 J009	9x0,8 mm	250	4,16	0472 J056	56x2 mm	50	68,64
0472 J010	10x1 mm	250	5,20	0472 J058	58x2 mm	50	73,84
0472 J011	11x1 mm	250	5,20	0472 J060	60x2 mm	50	75,92
0472 J012	12x1 mm	250	5,20	0472 J062	62x2 mm	50	80,08
0472 J013	13x1 mm	250	5,20	0472 J063	63x2 mm	50	125,84
0472 J014	14x1 mm	250	6,24	0472 J065	65x2,5 mm	25	109,20
0472 J015	15x1 mm	250	6,24	0472 J068	68x2,5 mm	25	121,68
0472 J016	16x1 mm	250	7,28	0472 J070	70x2,5 mm	25	132,08
0472 J017	17x1 mm	250	6,24	0472 J072	72x2,5 mm	25	136,24
0472 J018	18x1 mm	250	7,28	0472 J075	75x2,5 mm	25	149,76
0472 J019	19x1 mm	250	7,28	0472 J078	78x2,5 mm	25	153,92
0472 J020	20x1 mm	250	7,28	0472 J080	80x2,5 mm	25	160,16
0472 J021	21x1 mm	250	8,32	0472 J082	82x2,5 mm	10	163,28
0472 J022	22x1 mm	250	9,36	0472 J085	85x3 mm	10	174,72
0472 J023	23x1,2 mm	250	11,44	0472 J090	90x3 mm	10	195,52
0472 J024	24x1,2 mm	250	11,44	0472 J092	92x3 mm	10	205,92
0472 J025	25x1,2 mm	250	11,44	0472 J095	95x3 mm	10	234,00
0472 J026	26x1,2 mm	250	12,48	0472 J098	98x3 mm	10	286,00
0472 J027	27x1,2 mm	250	15,00	0472 J100	100x3 mm	10	276,64
0472 J028	28x1,2 mm	250	14,56	0472 J105	105x4 mm	5	371,28
0472 J029	29x1,2 mm	250	24,00	0472 J110	110x4 mm	5	418,08
0472 J030	30x1,2 mm	250	15,60	0472 J115	115x4 mm	5	454,48
0472 J031	31x1,2 mm	100	16,64	0472 J120	120x4 mm	5	495,04
0472 J032	32x1,2 mm	100	17,68	0472 J125	125x4 mm	5	552,24
0472 J033	33x1,5 mm	100	18,72	0472 J130	130x4 mm	5	610,48
0472 J034	34x1,5 mm	100	23,92	0472 J135	135x4 mm	5	677,04
0472 J035	35x1,5 mm	100	23,92	0472 J140	140x4 mm	5	732,16
0472 J036	36x1,5 mm	100	24,96	0472 J145	145x4 mm	5	783,12
0472 J037	37x1,5 mm	100	28,08	0472 J150	150x4 mm	5	817,44
0472 J038	38x1,5 mm	100	28,08	0472 J155	155x4 mm	5	915,20
0472 J040	40x1,75 mm	100	34,32	0472 J160	160x4 mm	5	1218,88
0472 J042	42x1,75 mm	100	37,44	0472 J165	165x4 mm	5	1295,84
0472 J044	44x1,75 mm	100	41,60	0472 J170	170x4 mm	5	1374,88
0472 J045	45x1,75 mm	100	41,60	0472 J175	175x4 mm	5	1460,16
0472 J046	46x1,75 mm	100	76,00	0472 J180	180x4 mm	5	1527,76
0472 J047	47x1,75 mm	100	43,68	0472 J185	185x4 mm	5	1504,88
0472 J048	48x1,75 mm	100	46,80	0472 J190	190x4 mm	5	1675,44
0472 J050	50x2 mm	50	48,88	0472 J200	200x4 mm	5	1842,88
0472 J052	52x2 mm	50	54,08				

MALETÍN SURTIDO 1880 UND - DIN 472 / VALISE ASSORTIMENT 1880 UNITES - DIN 472 / ASSORTED CASE 1880 PCS - DIN 472  
 ASSORTIMENTO 1880 PEZZI - DIN 472 / MALETA SORTIDA 1880 PÇS - DIN 472



Ref			
0472 9999	1880 uds	1	302,40

ANILLOS SEEGER RA DIN-6799 / ANNEAUX SEEGER RA DIN-6799 / DIN-6799 SEEGER RA RINGS  
 ANELLO SEEGER RA DIN-6799 / ANEIS SEEGER RA DIN-6799

Precio x 100 unidades / Price x 100 units



Ref	EJE			Ref	EJE		
6799 0002	RA 1,5	100	3,12	6799 0010	RA 8	100	5,20
6799 0003	RA 1,9	100	2,20	6799 0011	RA 9	100	7,28
6799 0004	RA 2,3	100	3,00	6799 0012	RA 10	100	8,40
6799 0005	RA 3,2	100	3,00	6799 0013	RA 12	100	18,72
6799 0006	RA 4	100	2,30	6799 0014	RA 15	100	24,96
6799 0007	RA 5	100	3,12	6799 0015	RA 19	50	44,00
6799 0008	RA 6	100	3,20	6799 0016	RA 24	50	84,00
6799 0009	RA 7	100	4,60				

MALETÍN SURTIDO DIN-6799 (3.300 UDS.) / VALISE ASSORTIMENT DIN-6799 (3.300 UNITES) / ASSORTED DIN-6799 CASE (3.300 UNITS)  
 ASSORTIMENTO ANELLI SEEGER DIN-6799 (3.300 PEZZI) / MALETA SORTIDA DIN-6799 (3.300 PÇS)



Ref		
09400222	ESTUCHE 12 COMPARTIMENTOS 250 x 200 x 44 mm	1
67990002	ANILLO SEEGER DIN-6799 RA-1,5	500
67990003	ANILLO SEEGER DIN-6799 RA-1,9	500
67990004	ANILLO SEEGER DIN-6799 RA-2,3	500
67990005	ANILLO SEEGER DIN-6799 RA-3,2	500
67990006	ANILLO SEEGER DIN-6799 RA-4	500
67990007	ANILLO SEEGER DIN-6799 RA-5	300
67990008	ANILLO SEEGER DIN-6799 RA-6	200
67990009	ANILLO SEEGER DIN-6799 RA-7	100
67990010	ANILLO SEEGER DIN-6799 RA-8	50
67990011	ANILLO SEEGER DIN-6799 RA-9	50
67990012	ANILLO SEEGER DIN-6799 RA-10	50
67990013	ANILLO SEEGER DIN-6799 RA-12	50

Ref			
0470 9999	3300 uds	1	148,94

PASADORES ELÁSTICOS / GOUPILLES / SPLIT PIN / SPINE ELASTICHE / CAVILHAS ELÁSTICAS

MALETÍN SURTIDO PASADORES ELÁSTICOS SERIE LARGA DIN-1481 (290 PCS) / VALISE ASSORTIMENT DE GOUPILLES ÉLASTIQUES LONGUE SÉRIE DIN-1481 (290 PCS)  
 ASSORTED DIN-1481 ELASTIC SPLIT PINS CASE LONG SERIES (290 UNITS) / ASSORTIMENTO DI SPINE ELASTICHE LUNGA SERIE DIN-1481 (290 PEZZI)  
 MALETA SORTIDA CAVILHAS ELÁSTICAS DIN-1481 (290 PÇS)

SERIE LARGA / LONG SERIE



Ref		
1481 0580	D-5x80	50 uds
1481 0660	D-6x60	50 uds
1481 0690	D-6x90	50 uds
1481 0750	D-7x50	20 uds
1481 0785	D-7x85	20 uds
1481 07100	D-7x100	20 uds
1481 0890	D-8x90	20 uds
1481 08120	D-8x120	20 uds
1481 1060	D-10x60	10 uds
1481 1095	D-10x95	10 uds
1481 1260	D-12x60	10 uds
1481 1275	D-12x75	10 uds
1481 0002	Maletín 364x268x66 mm	1 ud

Ref			
1481 0002	290 uds	1	180,60

PASADORES ELÁSTICOS DIN-1481 / GOUPILLES / SPLIT PIN / SPINE ELASTICHE IN ACCIAIO / CAVILHAS ELÁSTICAS

**Precio x 100 unidades / Price x 100 units**

Ref	EJE			Ref	EJE			Ref	EJE		
1481 1504	1,5 x 4	500	1,77	1481 0418	4 x 18	500	5,72	1481 0770	7 x 70	100	43,68
1481 1508	1,5 x 8	500	2,34	1481 0420	4 x 20	500	5,44	1481 0785	7 x 85	100	58,20
1481 1514	1,5 x 14	500	2,50	1481 0424	4 x 24	500	6,04	1481 07100	7 x 100	100	70,10
1481 1520	1,5 x 20	500	2,89	1481 0426	4 x 26	500	6,86	1481 0820	8 x 20	200	20,28
1481 0206	2 x 6	500	2,24	1481 0430	4 x 30	500	8,32	1481 0826	8 x 26	200	23,22
1481 0210	2 x 10	500	2,50	1481 0440	4 x 40	500	9,41	1481 0832	8 x 32	200	27,03
1481 0212	2 x 12	500	2,82	1481 0510	5 x 10	500	4,72	1481 0836	8 x 36	200	30,16
1481 0216	2 x 16	500	2,92	1481 0516	5 x 16	500	6,16	1481 0845	8 x 45	100	31,52
1481 0218	2 x 18	500	3,32	1481 0520	5 x 20	500	8,42	1481 0860	8 x 60	100	40,36
1481 0224	2 x 24	500	4,70	1481 0522	5 x 22	500	8,01	1481 0865	8 x 65	100	40,67
1481 0230	2 x 30	500	4,35	1481 0528	5 x 28	500	9,67	1481 0875	8 x 75	100	48,77
1481 2508	2,5 x 8	500	2,55	1481 0530	5 x 30	500	10,21	1481 0890	8 x 90	100	64,70
1481 2514	2,5 x 14	500	3,30	1481 0536	5 x 36	500	13,21	1481 08120	8 x 120	100	89,18
1481 2518	2,5 x 18	500	4,19	1481 0550	5 x 50	250	15,44	1481 1022	10 x 22	100	28,92
1481 2520	2,5 x 20	500	4,54	1481 0565	5 x 65	250	21,84	1481 1024	10 x 24	100	31,52
1481 2526	2,5 x 26	500	4,72	1481 0580	5 x 80	250	28,50	1481 1028	10 x 28	100	34,73
1481 0305	3 x 5	500	2,50	1481 0612	6 x 12	250	6,84	1481 1036	10 x 36	100	41,39
1481 0308	3 x 8	500	2,63	1481 0614	6 x 14	250	9,36	1481 1040	10 x 40	100	44,14
1481 0310	3 x 10	500	3,18	1481 0620	6 x 20	250	11,44	1481 1050	10 x 50	50	59,50
1481 0312	3 x 12	500	3,49	1481 0624	6 x 24	250	10,78	1481 1060	10 x 60	50	60,35
1481 0316	3 x 16	500	5,30	1481 0626	6 x 26	250	15,44	1481 1065	10 x 65	50	64,58
1481 0320	3 x 20	500	4,69	1481 0632	6 x 32	250	14,22	1481 1080	10 x 80	50	77,17
1481 0322	3 x 22	500	5,30	1481 0640	6 x 40	250	17,11	1481 1095	10 x 95	50	111,28
1481 0328	3 x 28	500	6,55	1481 0645	6 x 45	250	21,84	1481 1226	12 x 26	50	42,34
1481 0336	3 x 36	500	8,01	1481 0660	6 x 60	250	24,80	1481 1230	12 x 30	50	47,96
1481 0350	3 x 50	500	9,87	1481 0690	6 x 90	250	36,18	1481 1232	12 x 32	50	59,28
1481 3510	3,5 x 10	500	3,58	1481 0712	7 x 12	200	9,56	1481 1245	12 x 45	50	70,11
1481 3516	3,5 x 16	500	5,16	1481 0714	7 x 14	200	12,48	1481 1260	12 x 60	50	90,10
1481 3522	3,5 x 22	500	5,87	1481 0724	7 x 24	200	16,90	1481 1270	12 x 70	50	104,51
1481 3528	3,5 x 28	500	7,01	1481 0730	7 x 30	200	20,80	1481 1275	12 x 75	50	117,94
1481 3536	3,5 x 36	500	11,00	1481 0740	7 x 40	200	26,00				
1481 3550	3,5 x 50	500	15,15	1481 0750	7 x 50	100	31,11				
1481 0412	4 x 12	500	4,16	1481 0755	7 x 55	100	36,10				

 MALETÍN SURTIDO PASADORES ELÁSTICOS DIN -1481 (2.260 UDS) / VALISE ASSORTIMENT DE GOUPILLES ÉLASTIQUES DIN-1481 (2.260 UNITÉS)  
 ASSORTED DIN-1481 ELASTIC SPLIT PINS CASE (2.260 UNITS) / ASSORTIMENTO DI SPINE ELASTICHE DIN-1481 (2.260 UDS)  
 MALETA SORTIDA CAVILHAS ELÁSTICAS DIN-1481 (2.260 PÇS)

**SERIE NORMAL / STANDARD SERIE**

Ref				Ref		
1481 0580				1481 0580	2x10	400 uds
1481 0420				1481 0420	4x20	100 uds
1481 0640				1481 0640	6x40	50 uds
1481 0224				1481 0224	2x24	400 uds
1481 0426				1481 0426	4x26	100 uds
1481 0820				1481 0820	8x20	20 uds
1481 0308				1481 0308	3x8	200 uds
1481 0440				1481 0440	4x40	100 uds
1481 0836				1481 0836	8x36	20 uds
1481 0312				1481 0312	3x12	200 uds
1481 0510				1481 0510	5x10	50 uds
1481 0860				1481 0860	8x60	20 uds
1481 0320				1481 0320	3x20	200 uds
1481 0530				1481 0530	5x30	50 uds
1481 1024				1481 1024	10x24	20 uds
1481 0350				1481 0350	3x50	100 uds
1481 0550				1481 0550	5x50	50 uds
1481 1040				1481 1040	10x40	20 uds
1481 0412				1481 0412	4x12	100 uds
1481 0612				1481 0612	6x12	50 uds
1481 1230				1481 1230	12x30	10 uds
1481 0001	2260 uds	1	175,50	1481 0002	Maletín 364x268x66 mm	1 ud



PASADORES DE ALETA DIN-94 / GOUPILLES DIN-94 / SPLIT PINS DIN-94 / SPINE A COPPIGLIA DIN-94 / GOLPILHAS DIN-94

## Precio x 100 unidades / Price x 100 units



Ref	M	📦	📊	Ref	M	📦	📊
0020 1516	1,5x16 mm	500	2,50	0020 3563	3,5x63 mm	500	10,33
0020 1525	1,5x25 mm	500	2,60	0020 4025	4x2 5 mm	500	4,58
0020 1536	1,5x36 mm	500	2,86	0020 4032	4x32 mm	500	6,52
0020 2016	2x16 mm	500	1,99	0020 4036	4x36 mm	500	5,73
0020 2020	2x20 mm	500	2,50	0020 4040	4x40 mm	500	7,30
0020 2025	2x25 mm	500	2,20	0020 4045	4x4 5 mm	500	6,92
0020 2032	2x32 mm	500	3,20	0020 4050	4x50 mm	500	10,04
0020 2036	2x36 mm	500	2,91	0020 4056	4x56 mm	500	8,26
0020 2040	2x40 mm	500	3,90	0020 4063	4x63 mm	500	11,44
0020 2516	2,5x16 mm	500	2,17	0020 5025	5x25 mm	500	8,32
0020 2520	2,5x20 mm	500	2,28	0020 5032	5x32 mm	500	8,05
0020 2525	2,5x25 mm	500	2,40	0020 5045	5x45 mm	250	10,16
0020 2532	2,5x32 mm	500	2,96	0020 5063	5x63 mm	250	13,62
0020 2536	2,5x36 mm	500	3,31	0020 5070	5x70 mm	250	16,90
0020 2540	2,5x40 mm	500	4,01	0020 5080	5x80 mm	250	15,32
0020 2545	2,5x45 mm	500	5,08	0020 6340	6,3x40 mm	100	13,02
0020 2550	2,5x50 mm	500	5,86	0020 6350	6,3x50 mm	100	15,52
0020 3220	3,2x20 mm	500	2,42	0020 6363	6,3x63 mm	100	19,26
0020 3225	3,2x25 mm	500	2,60	0020 6380	6,3x80 mm	100	22,86
0020 3236	3,2x36 mm	500	4,04	0020 63100	6,3x100 mm	100	27,64
0020 3245	3,2x45 mm	500	4,15	0020 8050	8x50 mm	50	36,80
0020 3532	3,5x32 mm	500	4,91	0020 8071	8x71 mm	50	40,07
0020 3536	3,5x36 mm	500	4,86	0020 8090	8x90 mm	50	49,61
0020 3540	3,5x40 mm	500	5,41	0020 80100	8x100 mm	50	53,42
0020 3545	3,5x45 mm	500	5,95	0020 1063	10x63 mm	25	65,62
0020 3550	3,5x50 mm	500	9,80	0020 1090	10x90 mm	25	89,07
0020 3556	3,5x56 mm	500	6,98				

MALETÍN SURTIDO PASADORES DE ALETA DIN-94 (CONTENIDO 1200 PASADORES) / MALETTE ASSORTIMENT DE GOUPILLES DIN-94 (CONTIENT 1200 GOUPILLES)  
 ASSORTED DIN-94 SPLIT PINS CASE (1.200 UNITS) / VALIGETTA CON ASSORTIMENTO PERNI DIN-94 ( CONTIENE 1200 PERNI)  
 MALETA SORTIDA GOLPILHAS DIN-94 (1.200 PÇS)



Ref	📦	📊
0020 1536	M-1,5x36	100
0020 2040	M-2x40	100
0020 2540	M-2,5x40	100
0020 3245	M-3,2x45	100
0020 3540	M-3,5x40	100
0020 3550	M-3,5x50	100
0020 3563	M-3,5x63	100
0020 4032	M-4x32	100
0020 4040	M-4x40	100
0020 4050	M-4x50	100
0020 4063	M-4x63	100
0020 5063	M-5x63	50
0020 5070	M-5x70	50
0940 0223	Maletín 364x268x66 mm	1

Ref	📊	📦	📊
0401 0020	1200 uds	1	142,56



PASADORES CENTRO EJE / GOUPILLES / SPLIT PINS / SPINOTTI PER MOTOZAPPA / CAVILHA DE EIXO



Ref	M	↔	📦	🔗
0036 1000	6 mm	60 mm	50	0,676
0036 1001	8 mm	70 mm	50	0,983
0036 1002	10 mm	70 mm	50	1,014

PASADORES EN "R" / GOUPILLES "R" / SPLIT PINS "R" / COPPIGLIE A MOLLA "R" / CAVILHA EM "R"



Ref	M	↔	📦	🔗
0021 0002	2 mm	42 mm	50	0,075
0021 0003	3 mm	52 mm	50	0,099
0021 0004	4 mm	67 mm	50	0,230
0021 0005	5 mm	90 mm	50	0,440
0021 0006	6 mm	90 mm	50	0,720
0021 0007	7 mm	100 mm	50	0,780
0021 0008	8 mm	120 mm	25	1,446
0021 0010	10 mm	155 mm	25	8,216

PASADORES DE ANILLA / GOUPILLES / SPLIT PINS / SPINE A SCATTO / CAVILHAS DE MOLA



Ref	M	↔	📦	🔗
0036 0045	4,5 mm	37 mm	50	0,307
0036 0006	6 mm	37 mm	50	0,359
0036 0007	7 mm	40 mm	50	0,379
0036 0008	8 mm	46 mm	50	0,411
0036 0009	9 mm	46 mm	50	0,415
0036 0010	10 mm	46 mm	50	0,429
0036 0011	11 mm	46 mm	50	0,432

MALETÍN SURTIDO PASADORES "R" Y ANILLA (120 UDS) / VALISETTE ASSORTIMENT GOUPILLES "R" ET ANNEAUX (120 UNITES)  
 ASSORTED "R" AND ROUND SPLIT PINS CASE (120 UNITS) / VALIGETTA ASSORTITA SPINE ELASTICHE "R" E ANELLO (120 PEZZI)  
 MALA SORTIDA DE PINOS "R" E ANEIS (120 UNIDADES)



Ref	M	📦
0021 0002	2mm	10
0021 0003	3mm	10
0021 0004	4mm	10
0021 0005	5mm	10
0021 0006	6mm	10
0021 0008	8mm	10
0036 0045	4,5mm	10
0036 0006	6mm	10
0036 0007	7mm	10
0036 0008	8mm	10
0036 0009	9mm	10
0036 0010	10mm	10
0940 0223	Maletín 364x268x66 mm	1

Ref	↓	📦	🔗
0401 2136	120 uds	1	82,50

JUNTAS TÓRICAS NBR PULGADAS / JOINTS TORIQUES NBR POUÇES / INCHES NBR O-RINGS  
GIUNTI TORICI NBR IN POLLICI / ANÉIS DE RETENÇÃO NBR POLEGADAS

**Precio x 100 unidades / Price x 100 units**

**NBR**



ES El nitrilo NBR es un elastómero frecuentemente empleado en la industria de la estanqueidad por su excelente resistencia a todos los productos químicos, además de su alta capacidad de trabajo en una gama de temperaturas desde -30°C hasta 125°C.

FR Le nitrile NBR est un élastomère fréquemment utilisé dans le secteur de l'étanchéité, il a une excellente résistance à tous les produits chimiques ainsi qu'une grande capacité de résistance dans une grande fourchette de température, de -30° a 125° C.

EN NBR NITRILE is often used in tightness industry. High resistance to chemical products, work capacity from -30°C to 125°C.

IT Il nitrile NBR è un elastomero frequentemente impiegato nell'industria della tenuta stagna, per la sua eccellente resistenza a tutti i prodotti chimici ed alla capacità di impiego in una gamma di temperature da -30°C a 125°C.

PT O NITRILIO NBR é um elastómero frequentemente utilizado na indústria de estanqueidade. Alta resistência a produtos químicos, a capacidade de trabalho de -30°C a 125°C.

Ref				Ref				Ref			
T2,90x1,78	2,90x1,78 mm	200	3,74	T26,57x3,53	26,57x3,53 mm	50	17,47	T52,07x2,62	52,07x2,62 mm	50	30,58
T3,17x1,78	3,17x1,78 mm	200	4,37	T26,64x2,62	26,64x2,62 mm	50	14,35	T52,40x3,53	52,40x3,53 mm	50	35,05
T3,68x1,78	3,68x1,78 mm	200	4,37	T28,17x3,53	28,17x3,53 mm	50	19,34	T53,34x5,34	53,34x5,34 mm	50	78,42
T4,42x2,62	4,42x2,62 mm	200	5,62	T28,24x2,62	28,24x2,62 mm	50	15,70	T53,47x3,53	53,47x3,53 mm	50	35,05
T4,47x1,78	4,47x1,78 mm	200	4,37	T29,51x5,33	29,51x5,33 mm	50	30,16	T53,64x2,62	53,64x2,62 mm	50	30,58
T5,23x2,62	5,23x2,62 mm	200	6,34	T29,74x3,53	29,74x3,53 mm	50	19,97	T53,67x1,78	53,67x1,78 mm	50	26,62
T5,28x1,78	5,28x1,78 mm	200	4,37	T29,87x1,78	29,87x1,78 mm	50	16,22	T53,70x1,78	53,70x1,78 mm	50	26,83
T6,07x1,78	6,07x1,78 mm	200	4,78	T31,34x3,53	31,34x3,53 mm	50	19,97	T55,25x2,62	55,25x2,62 mm	50	31,30
T6,35x1,78	6,35x1,78 mm	200	4,99	T31,42x2,62	31,42x2,62 mm	50	18,10	T55,56x3,53	55,56x3,53 mm	50	36,30
T6,75x1,78	6,75x1,78 mm	200	4,99	T31,47x1,78	31,47x1,78 mm	50	16,64	T56,52x5,34	56,52x5,34 mm	50	78,42
T7,65x1,78	7,65x1,78 mm	200	4,99	T32,92x3,53	32,92x3,53 mm	50	21,22	T56,54x3,53	56,54x3,53 mm	50	38,06
T7,94x1,78	7,94x1,78 mm	200	5,62	T32,99x2,62	32,99x2,62 mm	50	18,82	T56,74x3,53	56,74x3,53 mm	50	36,71
T8,73x1,78	8,73x1,78 mm	200	5,62	T33,05x1,78	33,05x1,78 mm	50	17,16	T56,87x1,78	56,87x1,78 mm	50	28,18
T9,19x2,62	9,19x2,62 mm	200	6,86	T34,52x3,53	34,52x3,53 mm	50	22,46	T57,15x3,53	57,15x3,53 mm	50	38,06
T9,25x1,78	9,25x1,78 mm	200	5,62	T34,59x2,62	34,59x2,62 mm	50	19,34	T59,70x5,34	59,70x5,34 mm	50	80,08
T9,92x2,62	9,92x2,62 mm	200	6,86	T34,65x1,78	34,65x1,78 mm	50	18,10	T62,87x5,34	62,87x5,34 mm	50	78,42
T10,60x2,40	10,60x2,40 mm	200	7,18	T36,09x3,53	36,09x3,53 mm	50	23,71	T63,09x3,53	63,09x3,53 mm	50	42,43
T10,69x3,53	10,69x3,53 mm	200	9,46	T36,17x2,62	36,17x2,62 mm	50	19,97	T64,77x2,62	64,77x2,62 mm	50	35,67
T10,77x2,62	10,77x2,62 mm	200	6,86	T36,27x1,78	36,27x1,78 mm	50	19,34	T66,04x5,34	66,04x5,34 mm	50	78,42
T10,82x1,78	10,82x1,78 mm	200	5,62	T37,47x5,33	37,47x5,33 mm	50	35,46	T66,40x1,78	66,40x1,78 mm	50	36,19
T11,3x2,4	11,30x2,40 mm	200	7,18	T37,69x3,53	37,69x3,53 mm	50	25,58	T71,12x2,62	71,12x2,62 mm	50	38,69
T11,60x2,40	11,60x2,40 mm	200	7,49	T37,77x2,62	37,77x2,62 mm	50	20,59	T72,39x5,33	72,39x5,33 mm	50	83,20
T11,91x2,62	11,91x2,62 mm	200	6,86	T37,82x1,78	37,82x1,78 mm	50	20,90	T72,69x2,62	72,69x2,62 mm	50	39,94
T12,29x3,53	12,29x3,53 mm	200	9,26	T39,34x2,62	39,34x2,62 mm	50	20,59	T74,63x5,33	74,63x5,33 mm	50	84,34
T12,37x2,62	12,37x2,62 mm	200	6,86	T39,70x3,53	39,70x3,53 mm	50	25,27	T75,87x2,62	75,87x2,62 mm	10	41,81
T12,42x1,78	12,42x1,78 mm	200	6,97	T40,64x5,33	40,64x5,33 mm	50	35,57	T77,50x2,62	77,50x2,62 mm	10	43,78
T13,87x3,53	13,87x3,53 mm	200	9,98	T40,87x3,53	40,87x3,53 mm	50	23,92	T80,60x2,62	80,60x2,62 mm	10	48,78
T13,94x2,62	13,94x2,62 mm	200	7,49	T40,94x2,62	40,94x2,62 mm	50	20,59	T81,92x5,34	81,92x5,34 mm	10	94,64
T14x1,78	14,00x1,78 mm	100	6,97	T41,00x1,78	41,00x1,78 mm	50	21,94	T82,14x3,53	82,14x3,53 mm	10	56,26
T15,08x2,62	15,08x2,62 mm	100	8,74	T41,28x3,53	41,28x3,53 mm	50	28,70	T85,32x3,53	85,32x3,53 mm	10	58,14
T15,54x2,62	15,54x2,62 mm	100	8,74	T42,86x3,53	42,86x3,53 mm	50	28,70	T88,57x3,53	88,57x3,53 mm	10	59,07
T15,60x1,78	15,60x1,78 mm	100	12,48	T43,82x5,33	43,82x5,33 mm	50	36,92	T88,62x1,78	88,62x1,78 mm	10	54,18
T15,60x2,40	15,60x2,40 mm	100	12,69	T44,04x3,53	44,04x3,53 mm	50	30,58	T94,84x3,53	94,84x3,53 mm	10	63,75
T15,88x2,62	15,88x2,62 mm	100	8,74	T44,12x2,62	44,12x2,62 mm	50	23,71	T101,27x2,62	101,27x2,62 mm	10	61,88
T17,86x2,62	17,86x2,62 mm	100	9,46	T44,17x1,78	44,17x1,78 mm	50	25,06	T104,14x5,33	104,14x5,33 mm	10	113,78
T18,64x3,53	18,64x3,53 mm	100	12,58	T45,69x2,62	45,69x2,62 mm	50	25,58	T104,4x1,78	104,4x1,78 mm	10	67,70
T18,72x2,62	18,72x2,62 mm	100	9,98	T46,04x3,53	46,04x3,53 mm	50	30,99	T107,32x5,34	107,32x5,34 mm	10	149,76
T20,22x3,53	20,22x3,53 mm	100	13,73	T46,99x5,34	46,99x5,34 mm	50	31,72	T113,67x6,99	113,67x6,99 mm	10	163,28
T20,30x2,62	20,30x2,62 mm	100	11,23	T47,22x3,53	47,22x3,53 mm	50	32,55	T113,98x2,62	113,98x2,62 mm	10	69,37
T20,64x2,62	20,64x2,62 mm	100	12,58	T47,29x2,62	47,29x2,62 mm	50	25,58	T136,12x3,53	136,12x3,53 mm	10	117,62
T21,82x3,53	21,82x3,53 mm	100	14,35	T47,35x1,78	47,35x1,78 mm	50	25,48	T139,07x5,33	139,07x5,33 mm	10	160,06
T21,89x2,62	21,89x2,62 mm	100	13,10	T48,90x2,62	48,90x2,62 mm	50	26,21	T139,70x5,33	139,70x5,33 mm	10	165,67
T23,39x3,53	23,39x3,53 mm	50	16,22	T50,16x5,34	50,16x5,34 mm	50	46,90	T142,27x3,53	142,27x3,53 mm	10	123,86
T23,47x2,62	23,47x2,62 mm	50	13,73	T50,39x3,53	50,39x3,53 mm	50	47,22	T152,72x2,62	152,72x2,62 mm	10	131,87
T24,99x3,53	24,99x3,53 mm	50	16,22	T50,51x1,78	50,51x1,78 mm	50	26,83				
T25,80x3,53	25,80x3,53 mm	50	17,47	T50,80x3,53	50,80x3,53 mm	50	34,42				

**JUNTAS TÓRICAS NBR MÉTRICAS / JOINTS TORIQUES NBR MÉTRIQUES / METRIC NBR O-RINGS  
GIUNTI TORICI NBR METRICI / ANÉIS DE RETENÇÃO NBR MÉTRICAS**

Ref				Ref				Ref			
T3x1	3 x 1 mm	200	4,37	T26x3	26 x 3 mm	100	17,68	T54x3,5	54 x 3,5 mm	50	41,81
T3x2	3 x 2 mm	200	4,99	T26x4	26 x 4 mm	100	24,23	T55x2	55 x 2 mm	50	36,82
T4x1,5	4 x 1,5 mm	200	4,99	T27x2	27 x 2 mm	100	17,68	T55x2,5	55 x 2,5 mm	50	35,46
T4x2	4 x 2 mm	200	4,26	T27x2,5	27 x 2,5 mm	100	17,68	T55x3	55 x 3 mm	50	36,82
T4x2,5	4 x 2,5 mm	200	4,99	T27x3	27 x 3 mm	100	17,68	T56x2	56 x 2 mm	50	37,44
T5x1	5 x 1 mm	200	4,99	T28x2,5	28 x 2,5 mm	100	18,41	T57x2,5	57 x 2,5 mm	50	36,82
T5x2	5 x 2 mm	200	4,37	T28x3	28 x 3 mm	100	18,30	T57x3	57 x 3 mm	50	37,44
T5x2,5	5 x 2,5 mm	200	4,99	T29x3	29 x 3 mm	100	18,30	T58x6	58 x 6 mm	50	76,02
T6x2	6 x 2 mm	200	4,99	T29x3,5	29 x 3,5 mm	100	22,15	T59x2	59 x 2 mm	50	38,69
T6x2,5	6 x 2,5 mm	200	5,72	T30x1,5	30 x 1,5 mm	50	17,06	T59x2,5	59 x 2,5 mm	50	37,44
T6x4	6 x 4 mm	200	9,57	T30x2	30 x 2 mm	50	19,66	T59x3	59 x 3 mm	50	38,17
T7x1,5	7 x 1,5 mm	200	5,72	T30x2,5	30 x 2,5 mm	50	20,38	T60x3	60 x 3 mm	50	38,69
T7x2	7 x 2 mm	200	5,72	T30x3	30 x 3 mm	50	18,30	T62x2	62 x 2 mm	50	39,94
T7,5x2	7,5 x 2 mm	200	5,10	T30x4	30 x 4 mm	50	26,62	T62x3	62 x 3 mm	50	39,31
T8x1,5	8 x 1,5 mm	200	6,24	T30x5	30 x 5 mm	50	35,36	T62x3,5	62 x 3,5 mm	50	49,40
T8x2	8 x 2 mm	200	5,72	T31x1,5	31 x 1,5 mm	50	17,06	T62x8	62 x 8 mm	50	410,80
T8x2,5	8 x 2,5 mm	200	6,86	T31x2	31 x 2 mm	50	20,38	T63x2	63 x 2 mm	50	41,29
T8x3	8 x 3 mm	200	6,86	T31x2,5	31 x 2,5 mm	50	20,38	T63x2,5	63 x 2,5 mm	50	39,31
T9x1	9 x 1 mm	200	6,24	T31x3	31 x 3 mm	50	19,03	T63x3	63 x 3 mm	50	39,31
T9x1,5	9 x 1,5 mm	200	4,99	T31x3,5	31 x 3,5 mm	50	22,88	T64x2,5	64 x 2,5 mm	50	40,04
T9x2	9 x 2 mm	200	6,86	T31x4	31 x 4 mm	50	27,87	T64x3	64 x 3 mm	50	39,31
T9x2,5	9 x 2,5 mm	200	7,59	T32x1,5	32 x 1,5 mm	50	17,68	T65x3	65 x 3 mm	50	39,94
T9x3	9 x 3 mm	200	6,86	T32x2	32 x 2 mm	50	21,01	T69x10	69 x 10 mm	50	410,80
T9x3,5	9 x 3,5 mm	200	8,84	T32x2,5	32 x 2,5 mm	50	21,01	T70x2	70 x 2 mm	50	48,78
T10x1	10 x 1 mm	200	6,24	T32x3	32 x 3 mm	50	19,66	T70x2,5	70 x 2,5 mm	50	43,68
T10x1,5	10 x 1,5 mm	200	6,24	T32x3,5	32 x 3,5 mm	50	24,23	T70x3,5	70 x 3,5 mm	50	54,50
T10x2	10 x 2 mm	200	6,86	T33x2,5	33 x 2,5 mm	50	21,01	T71x2,5	71 x 2,5 mm	50	45,03
T10x2,5	10 x 2,5 mm	200	7,59	T34x2	34 x 2 mm	50	22,15	T72x1,5	72 x 1,5 mm	50	42,02
T10x3	10 x 3 mm	200	8,84	T34x2,5	34 x 2,5 mm	50	21,01	T73x3	73 x 3 mm	50	45,55
T11x2	11 x 2 mm	200	7,59	T34x3	34 x 3 mm	50	21,01	T74x2	74 x 2 mm	50	50,75
T11x2,5	11 x 2,5 mm	200	8,22	T34x4	34 x 4 mm	50	31,20	T74x3	74 x 3 mm	50	46,28
T11x3	11 x 3 mm	200	8,84	T34x5	34 x 5 mm	50	36,09	T75x2	75 x 2 mm	50	51,27
T12x1,5	12 x 1,5 mm	200	6,24	T35x1,5	35 x 1,5 mm	50	19,03	T75x3	75 x 3 mm	50	51,27
T12x2	12 x 2 mm	200	7,59	T35x2,5	35 x 2,5 mm	50	22,15	T76x2	76 x 2 mm	10	51,90
T12x2,5	12 x 2,5 mm	200	8,22	T35x3	35 x 3 mm	50	21,53	T79x2,5	79 x 2,5 mm	10	51,90
T12x3	12 x 3 mm	200	9,57	T35x4	35 x 4 mm	50	31,62	T79x5	79 x 5 mm	10	83,51
T13x1	13 x 1 mm	200	6,24	T36x2	36 x 2 mm	50	22,88	T80x1,5	80 x 1,5 mm	10	45,55
T13x2	13 x 2 mm	200	8,22	T36x2,5	36 x 2,5 mm	50	22,88	T80x2,5	80 x 2,5 mm	10	52,42
T13x2,5	13 x 2,5 mm	200	8,84	T36x3	36 x 3 mm	50	22,36	T80x3	80 x 3 mm	10	53,25
T13x3	13 x 3 mm	200	10,19	T36x6	36 x 6 mm	50	45,76	T80x4	80 x 4 mm	10	77,90
T13x3,5	13 x 3,5 mm	200	12,06	T37x2,5	37 x 2,5 mm	50	22,88	T81x2,5	81 x 2,5 mm	10	53,25
T14x1,5	14 x 1,5 mm	100	6,86	T37x3	37 x 3 mm	50	22,15	T82x3	82 x 3 mm	10	53,77
T14x2	14 x 2 mm	100	8,84	T38x3	38 x 3 mm	50	22,15	T82x3,5	82 x 3,5 mm	10	66,56
T14x2,5	14 x 2,5 mm	100	8,84	T38x4	38 x 4 mm	50	29,43	T82x4	82 x 4 mm	10	49,50
T14x3	14 x 3 mm	100	10,19	T38x5	38 x 5 mm	50	40,66	T82x5	82 x 5 mm	10	47,94
T14x3,5	14 x 3,5 mm	100	12,06	T39x2	39 x 2 mm	50	24,75	T83x2	83 x 2 mm	10	58,24
T14x4	14 x 4 mm	100	15,29	T39x3	39 x 3 mm	50	22,88	T83x3	83 x 3 mm	10	53,77
T15x2,5	15 x 2,5 mm	100	9,57	T40x2	40 x 2 mm	50	25,38	T83x5	83 x 5 mm	10	87,98
T15x3	15 x 3 mm	100	11,54	T40x2,5	40 x 2,5 mm	50	24,23	T84x2	84 x 2 mm	10	59,38
T15x3,5	15 x 3,5 mm	100	13,21	T40x3	40 x 3 mm	50	22,88	T84x3,5	84 x 3,5 mm	10	68,43
T15x4	15 x 4 mm	100	15,91	T41x2,5	41 x 2,5 mm	50	24,23	T85x3,5	85 x 3,5 mm	10	69,06
T16x2	16 x 2 mm	100	10,92	T42x1,5	42 x 1,5 mm	50	22,15	T85x4	85 x 4 mm	10	81,85
T16x2,5	16 x 2,5 mm	100	10,92	T42x2	42 x 2 mm	50	26,62	T86x2	86 x 2 mm	10	62,09
T17x2,5	17 x 2,5 mm	100	11,65	T42x2,5	42 x 2,5 mm	50	24,75	T86x2,5	86 x 2,5 mm	10	57,72
T18x2	18 x 2 mm	100	10,92	T42x3	42 x 3 mm	50	26,21	T87x2	87 x 2 mm	10	63,13
T18x3	18 x 3 mm	100	13,42	T42x4	42 x 4 mm	50	40,56	T87x2,5	87 x 2,5 mm	10	58,24
T19x1,5	19 x 1,5 mm	100	9,57	T43x3	43 x 3 mm	50	27,14	T87x3,5	87 x 3,5 mm	10	70,41
T19x2	19 x 2 mm	100	12,06	T44x2	44 x 2 mm	50	27,14	T88x2	88 x 2 mm	10	63,65
T19x2,5	19 x 2,5 mm	100	12,69	T44x3,5	44 x 3,5 mm	50	32,86	T88x4	88 x 4 mm	10	42,64
T19x3	19 x 3 mm	100	13,94	T44x4	44 x 4 mm	50	41,29	T89x4	89 x 4 mm	10	84,86
T19x3,5	19 x 3,5 mm	100	15,29	T45x3	45 x 3 mm	50	28,70	T90x2	90 x 2 mm	10	65,00
T19x4	19 x 4 mm	100	18,30	T45x4	45 x 4 mm	50	41,81	T90x2,5	90 x 2,5 mm	10	61,57
T20x1,5	20 x 1,5 mm	100	10,92	T45x5	45 x 5 mm	50	47,42	T90x3	90 x 3 mm	10	63,23
T20x2	20 x 2 mm	100	12,69	T46x2,5	46 x 2,5 mm	50	29,22	T92x2,5	92 x 2,5 mm	10	63,23
T20x2,5	20 x 2,5 mm	100	12,69	T46x3	46 x 3 mm	50	29,85	T92x3	92 x 3 mm	10	64,27
T20x3	20 x 3 mm	100	14,56	T47x2	47 x 2 mm	50	31,20	T93x3	93 x 3 mm	10	64,27
T20x3,5	20 x 3,5 mm	100	15,91	T47x2,5	47 x 2,5 mm	50	29,85	T94x3	94 x 3 mm	10	64,27
T20x4,5	20 x 4,5 mm	100	23,19	T48x2,5	48 x 2,5 mm	50	30,99	T94x4	94 x 4 mm	10	90,69
T22x1,5	22 x 1,5 mm	100	12,06	T48x3	48 x 3 mm	50	31,62	T95x4	95 x 4 mm	10	90,69
T22x2	22 x 2 mm	100	13,94	T49x3	49 x 3 mm	50	32,14	T96x2	96 x 2 mm	10	69,68
T22x2,5	22 x 2,5 mm	100	14,56	T49x7	47 x 9 mm	50	156,00	T97x5	97 x 5 mm	10	102,65
T22x3	22 x 3 mm	100	15,81	T50x2	50 x 2 mm	50	35,46	T98x3	98 x 3 mm	10	65,00
T23x1,5	23 x 1,5 mm	100	12,69	T50x3	50 x 3 mm	50	36,09	T100x1,5	100 x 1,5 mm	10	76,02
T23x2	23 x 2 mm	100	14,56	T50x3,5	50 x 3,5 mm	50	39,31	T100x2	100 x 2 mm	10	73,53
T23x2,5	23 x 2,5 mm	100	15,29	T50x4	50 x 4 mm	50	46,90	T100x3	100 x 3 mm	10	67,18
T24x2	24 x 2 mm	100	15,29	T51x3	51 x 3 mm	50	34,84	T102x2,5	102 x 2,5 mm	10	73,53
T24x2,5	24 x 2,5 mm	100	15,91	T52x1,5	52 x 1,5 mm	50	31,20	T103x3	103 x 3 mm	10	69,06
T24x3	24 x 3 mm	100	17,06	T52x2	52 x 2 mm	50	36,09	T103x3,5	103 x 3,5 mm	10	84,86
T24x4,5	24 x 4,5 mm	100	26,00	T52x3	52 x 3 mm	50	34,84	T104x2	104 x 2 mm	10	82,58
T25x2	25 x 2 mm	100	15,50	T53x2	53 x 2 mm	50	36,82	T104x3	104 x 3 mm	10	71,76
T25x2,5	25 x 2,5 mm	100	16,54	T53x3	53 x 3 mm	50	35,46	T110x3	110 x 3 mm	10	78,52
T25x3	25 x 3 mm	100	17,37	T54x2	54 x 2 mm	50	36,82	T135x4	135 x 4 mm	10	149,55
T25x5	25 x 5 mm	100	29,22	T54x2,5	54 x 2,5 mm	50	34,84	T139x3	139 x 3 mm	10	127,82
T26x2	26 x 2 mm	100	17,06	T54x3	54 x 3 mm	50	36,82				

SURTIDO DE JUNTAS TÓRICAS EN PULGADAS / COFFRET ASSORTIMENT DE JOINTS TORIQUES EN POUÇES / O-RINGS (INCHES) PLASTIC BOX  
CONTENITORE IN PLASTICA CON O-RING IN POLLICI / SORTIDO DE ANÉIS DE RETENÇÃO EN PULGADAS



**NBR**  
**Inches / Pulgadas**

Ref	○	↓	☐	☰
0460 0006	2,90 x 1,78 - 43,82 x 5,33	382 pcs	1	43,99

MALETA CON JUNTAS TÓRICAS / COFFRET ASSORTIMENT DE JOINTS TORIQUES NBR / O-RINGS NBR PLASTIC BOX  
CONTENITORE IN PLASTICA CON O-RING NBR / MALETA COM ANÉIS DE RETENÇÃO



**NBR**  
**Inches / Pulgadas**

Ref	○	↓	☐	☰
0460 0001	2,90 x 1,78 - 23,40 x 3,53	750 pcs	1	64,46
0460 0002	24,99 x 3,53 - 66,04 x 5,33	300 pcs	1	64,46

SURTIDO DE JUNTAS TÓRICAS "MÉTRICAS" / COFFRET ASSORTIMENT DE JOINTS TORIQUES "MÉTRIQUE" / O-RINGS "METRIC" PLASTIC BOX  
CONTENITORE IN PLASTICA CON O-RING "METRICI" / SORTIDO DE ANÉIS DE RETENÇÃO "MÉTRICAS"



**NBR**  
**Métrica / Metric**

Ref	○	↓	☐	☰
0460 0005	3 x 2 - 45 x 4	404 pcs	1	43,99

MALETA CON JUNTAS TÓRICAS / COFFRET ASSORTIMENT DE JOINTS TORIQUES NBR / O-RINGS NBR PLASTIC BOX  
CONTENITORE IN PLASTICA CON O-RING NBR / MALETA COM ANÉIS DE RETENÇÃO



**NBR**  
**Métrica / Metric**

Ref	○	↓	☐	☰
0460 0003	3 x 2 - 24 x 2,5	750 pcs	1	64,46
0460 0004	24 x 3 - 51 x 3	330 pcs	1	64,46





	ES	FR	EN	IT	PT
<b>Ref</b>	Referencia	Référence	Reference	Riferimento	Referência
	Diámetro del taladro	Diamètre du foret	Drill diameter	Diametro foratura	Diâmetro da perfuração
	Contenido	Contenu	Contents	Contenuto	Conteúdo
	Packing	Conditionnement	Packing	Imballo	Embalagem
	Precio	Prix	Price	Prezzo	Preço
	Longitud del taco	Longueur de la pièce	Fixing plug length	Lunghezza del tassello	Comprimento da bucha
	Profundidad zona expansión	Profondeur expansion zone	Expansion zone depth	Profondità zona espansione	Profundidade da zona de expansão
	Diámetro del tornillo	Diamètre de la vis	Screw diameter	Diametro viti	Diâmetro do parafuso
<b>M</b>	Métrica	Métrique	Metric	Metrica	Métrica
Espesor pared	Espesor pared	Épaisseur mur	Thickness wall	Spessore parete	Espessura da parede
	Espesor a fijar S	Épaisseur à fixer S	Thickness to be fixed S	Spessore attaccare	Espessura a fixar S
	Unidad mínima de venta	Nombre d'unités minimum de vente	Minimum sale unit	Quantitativo minimo di vendita	Unidade mínima de venda
	Diámetro	Diamètre	Diameter	Diametro	Diâmetro
	Color	Couleur	Color	Colore	Cor
	Rosca	Filetage	Thread	Rivettatura	Rosca entrada de ar PT
	Grosor, espesor	Grosueur, épaisseur	Thickness	Spessore o larghezza	Grossura, espessura
	Longitud	Longueur	Length	Lunghezza	Comprimento
	Capacidad, depósito	Capacité	Capacity	Capacité	Capacidade
	Capacidad remachado	Capacité rivet	Rivets capacity	Capacità rivetto	Capacidade rebites
	Blíster	Blisters	Blister	Blister	Blister
	Medidas tornillo	Mesures vis	Measures screw	Misura vite	Medidas do parafuso
<b>M mínima</b>	M mínima	M minimum	M minimum	M minima	M mínima
<b>M máxima</b>	M máxima	M maximum	M maximum	M massima	M máxima
<b>EJE</b>	Medida eje	Mesure Axe	Axle measure	Misura asse	Medida eixo
	Descripción	Description	Description	Descrizione	Descrição
	Junta tórica más pequeña y más grande	Joints torique du plus petit au plus grand	The smallest and the biggest o-ring	Dimesione minima e massima degli O-ring	Anel de retenção menor e maior





● cofan





# ÍNDICE / INDEX / CONTENTS

## INDICE / ÍNDICE



**574**

SUJETACABLES / SERRE-CÂBLES / WIRE ROPE CLIPS  
FERMACAVO / CERRA CABOS



**581**

TENSORES / TENDEURS / TENSION ADJUSTERS  
TENDITORI / ESTICADORES



**576**

MOSQUETONES / MOSQUETONS / SNAPS  
MOSCHETTONI / MOSQUETÕES



**583**

ACCESORIOS / ACCESSOIRES / ACCESSORIES  
ACCESSORI / ACESSÓRIOS



**578**

POLEAS / POULIES / PULLEYS  
CARRUCOLE / POLIAS



**593**

CADENAS / CHAINES / CHAIN  
CATENE / CABOS



**579**

ANILLA DE ELEVACIÓN / ANNEAUX DE LEVAGE  
ELEVATION RINGS / GOLFARI / ANÉIS DE ELEVAÇÃO



**593**

CABLE / CÂBLE / CABLE  
CAVI / CABO



**580**

GRILLETES / DROITE / STRAIGHT SHACKLES  
GRILLI DRITTI / MANILHAS



**595**

CINTA PERSIANA / RUBAN STORE / TAPE BLIND  
NASTRO TAPPARELLA / FITAS PERSIANAS





**596**

ESLINGAS / ELINGUES / SLING  
CINGHIA / ESLINGA



**612**

ALAMBRES Y MALLAS METÁLICAS  
FIL ET MAILLE MÉTALLIQUE / WIRE AND METALLIC MESHES  
FILI E RETI METALLICHE / ARAME E MALHAS METÁLICAS



**597**

CONJUNTO DE TRINCAJE / SET SANGLE  
RATCHET STRAPS / SET TENDICINGHIA  
CONJUNTO DE AMARRAÇÃO

**i**

**614**

GLOSARIO / GLASSAIRE / GLOSSARY  
GLOSSARIO / GLOSSÁRIO



**599**

ACCESORIOS ESLINGAS / ACCESSOIRES POUR ELINGUES  
RATCHET STRAPS AND HOOKS / ACCESSORI CINGHIE  
ACESSÓRIOS ESLINGAS



**600**

CUERDAS / CORDERIE / CORDS  
CORDE / CORDAS



**611**

PULPOS / ÉLASTIQUES RONDS / ELASTIC STRAPS  
CORDE ELASTICHE / GANCHOS



SUJETACABLES DIN-741 GALVANIZADOS / SERRE-CÂBLES DIN-741 ZINGUE / ZINC WIRE ROPE CLIP DIN-741  
FERMACAVO DIN-741 ZINCATO / CERRA CABOS DIN-741 ZINCADOS



Ref	M	Ø		
1800 1001	3 - 4 mm	1/8	200	0,15
1800 1002	5 mm	3/16	200	0,17
1800 1003	6 mm	1/4	100	0,19
1800 1004	8 mm	5/16	100	0,24
1800 1005	10 mm	3/8	50	0,58
1800 1006	11 mm	7/16	50	0,49
1800 1007	12 mm	1/2	25	0,96
1800 1008	14 mm	9/16	25	0,92
1800 1009	16 mm	5/8	10	1,31
1800 1010	20 mm	3/4	10	1,55
1800 1011	22 mm	7/8	10	2,39
1800 1012	24 mm	1"	5	2,81
1800 1013	30 mm	1" 3/16	5	4,20
1800 1014	34 mm	1" 3/8	1	6,82
1800 1015	40 mm	1" 9/16	1	8,52

Medidas / Dimensions

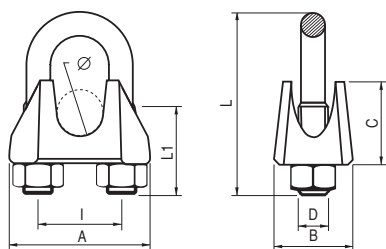

M	Ø	A	B	C	D	I	L	L1
3 - 4	1/8	21 mm	10 mm	10 mm	M-4	9 mm	20 mm	12 mm
5	3/16	24 mm	11 mm	10 mm	M-5	11 mm	24 mm	13 mm
6	1/4	26 mm	12 mm	11 mm	M-5	13 mm	28 mm	15 mm
8	5/16	30 mm	14 mm	15 mm	M-6	16 mm	34 mm	19 mm
10	3/8	37 mm	20 mm	19 mm	M-8	20 mm	42 mm	22 mm
11	7/16	38 mm	20 mm	20 mm	M-8	21 mm	44 mm	22 mm
12	1/2	44 mm	25 mm	23 mm	M-10	25 mm	55 mm	30 mm
14	9/16	46 mm	25 mm	25 mm	M-10	27 mm	57 mm	30 mm
16	5/8	52 mm	28 mm	28 mm	M-12	30 mm	63 mm	33 mm
20	3/4	58 mm	32 mm	34 mm	M-12	34 mm	75 mm	38 mm
22	7/8"	64 mm	35 mm	35 mm	M-14	38 mm	85 mm	44 mm
24	1"	68 mm	38 mm	38 mm	M-14	42 mm	95 mm	45 mm
30	1" 3/16	80 mm	40 mm	45 mm	M-16	50 mm	110 mm	50 mm
34	1" 3/8	88 mm	45 mm	52 mm	M-16	54 mm	120 mm	55 mm
40	1" 9/16	95 mm	48 mm	58 mm	M-16	60 mm	140 mm	60 mm

SUJETACABLES PLANOS SIMPLES / SERRE-CÂBLES SIMPLE / SIMPLE FLAT WIRE ROPE CLIP  
FERMACAVO PIANO SEMPLICE / CERRA CABOS PLANO SIMPLES



Ref	M		
1800 1101	2 mm	200	0,48
1800 1102	3 mm	200	0,57
1800 1103	4 mm	100	0,64
1800 1104	5 mm	100	0,70
1800 1105	6 mm	50	0,92
1800 1106	8 mm	50	1,37
1800 1107	10 mm	50	1,87

Medidas / Dimensions

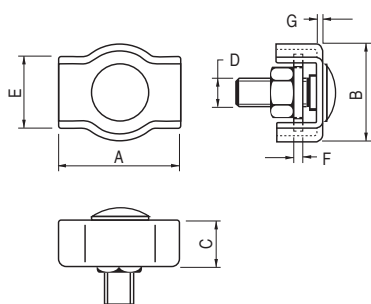

M	A	B	C	D	E	F	G
2	17,5 mm	12 mm	5,0 mm	M-4	7,5 mm	1,0 mm	1,0 mm
3	17,5 mm	15 mm	6,5 mm	M-4	10,0 mm	1,5 mm	1,5 mm
4	22,0 mm	18 mm	7,5 mm	M-5	12,0 mm	1,5 mm	1,5 mm
5	24,0 mm	20 mm	8,5 mm	M-5	14,0 mm	1,5 mm	1,5 mm
6	30,0 mm	23 mm	10,0 mm	M-6	17,0 mm	1,5 mm	1,5 mm
8	36,0 mm	30 mm	14,0 mm	M-8	22,0 mm	2,0 mm	2,0 mm
10	42,0 mm	34 mm	16,0 mm	M-10	25,0 mm	3,0 mm	2,0 mm



SUJETACABLES PLANOS DOBLES / SERRE-CÂBLES PLAT / FLAT DOUBLE WIRE ROPE CLIP / FERMACAVO DOPPIO / CERRA CABOS PLANO DUPLO



Ref	M		
1800 1201	2 mm	200	1,02
1800 1202	3 mm	100	1,05
1800 1203	4 mm	100	1,05
1800 1204	5 mm	100	1,20
1800 1205	6 mm	50	1,58
1800 1206	8 mm	25	3,42
1800 1207	10 mm	25	4,23

Medidas / Dimensions

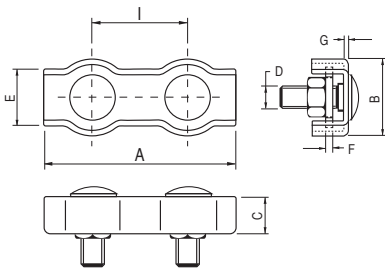

M	A	B	C	D	E	F	G
2	17,5 mm	12 mm	5,0 mm	M-4	7,5 mm	1,0 mm	1,0 mm
3	17,5 mm	15 mm	6,5 mm	M-4	10 mm	1,5 mm	1,5 mm
4	22,0 mm	18 mm	7,5 mm	M-5	12 mm	1,5 mm	1,5 mm
5	24,0 mm	20 mm	8,5 mm	M-5	14 mm	1,5 mm	1,5 mm
6	30,0 mm	23 mm	10,0 mm	M-6	17 mm	1,5 mm	1,5 mm
8	36,0 mm	30 mm	14,0 mm	M-8	22 mm	2,0 mm	2,0 mm
10	42,0 mm	34 mm	16,0 mm	M-10	25 mm	3,0 mm	2,0 mm

GUARDACABOS DIN-6899A / PASSE-CÂBLES DIN-6899A / THIMBLE DIN-6899A / GUIDA CAVO DIN-6899A / SAPATILHOS DIN-6899A



Ref	Ø		
1800 3301	3 mm	100	0,19
1800 3302	4 mm	100	0,23
1800 3303	5 mm	100	0,24
1800 3304	6 mm	100	0,28
1800 3306	8 mm	50	0,37
1800 3307	10 mm	50	0,52
1800 3309	12 mm	25	0,78
1800 3310	14 mm	10	1,06
1800 3311	16 mm	10	1,72
1800 3312	18 mm	10	2,52
1800 3313	20 mm	1	3,82
1800 3314	24 mm	1	6,88

ANILLAS SOLDADAS / ANNEAU SOUDÉ / WELDED RING / ANELLO SALDATO / ANEL SOLDADO

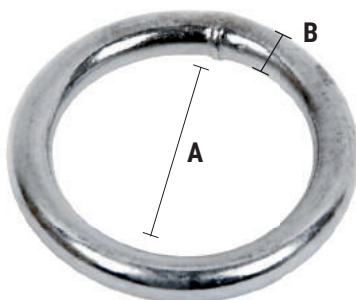

Ref	A x B		
1800 4101	3 x 20 mm	200	0,20
1800 4102	4 x 30 mm	200	0,31
1800 4103	5 x 40 mm	100	0,40
1800 4104	6 x 40 mm	100	0,58
1800 4105	6 x 50 mm	50	0,61
1800 4106	8 x 50 mm	25	1,16
1800 4107	8 x 60 mm	25	1,18
1800 4108	8 x 80 mm	10	1,42
1800 4109	9 x 50 mm	10	1,61



MOSQUETÓN BOMBERO / MOUSQUETON POMPIER / SPRING HOOK / MOSCHETTONE / MOSQUETÃO BOMBEIRO



Ref	B x L		
<b>1800 2501</b>	4 x 40 mm	200	<b>0,45</b>
<b>1800 2502</b>	5 x 50 mm	100	<b>0,50</b>
<b>1800 2503</b>	6 x 60 mm	100	<b>0,53</b>
<b>1800 2504</b>	7 x 70 mm	100	<b>0,73</b>
<b>1800 2505</b>	8 x 80 mm	50	<b>0,86</b>
<b>1800 2506</b>	9 x 90 mm	25	<b>1,26</b>
<b>1800 2507</b>	10 x 100 mm	25	<b>1,49</b>
<b>1800 2508</b>	11 x 120 mm	10	<b>2,28</b>
<b>1800 2509</b>	12 x 140 mm	10	<b>2,81</b>
<b>1800 2510</b>	13 x 160 mm	10	<b>4,76</b>

Medidas / Dimensions

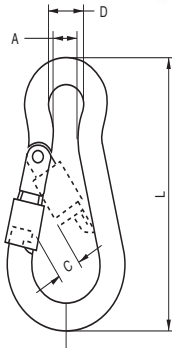

M	A	B	C	D	L	
4 x 40	7 mm	4 mm	6 mm	7 mm	40 mm	30 kg
5 x 50	8 mm	5 mm	7 mm	8 mm	50 mm	100 kg
6 x 60	9 mm	6 mm	8 mm	9 mm	60 mm	120 kg
7 x 70	10 mm	7 mm	8 mm	10 mm	70 mm	180 kg
8 x 80	12 mm	8 mm	10 mm	11 mm	80 mm	230 kg
9 x 90	12 mm	9 mm	10 mm	12 mm	90 mm	250 kg
10 x 100	15 mm	10 mm	11 mm	13 mm	100 mm	350 kg
11 x 120	18 mm	11 mm	16 mm	14 mm	120 mm	380 kg
12 x 140	20 mm	12 mm	19 mm	15 mm	140 mm	400 kg
13 x 160	22 mm	13 mm	23 mm	16 mm	160 mm	410 kg

MOSQUETÓN CON SEGURO / MOUSQUETON AVEC SÉCURITÉ / SNAP WITH FASTENER / MOSCHETTONE CON SICUREZZA / MOSQUETÃO COM TRAVA



Ref	B x L		
<b>1800 2601</b>	6 x 60 mm	50	<b>0,91</b>
<b>1800 2602</b>	7 x 70 mm	50	<b>1,20</b>
<b>1800 2603</b>	8 x 80 mm	50	<b>1,41</b>
<b>1800 2604</b>	9 x 90 mm	25	<b>1,82</b>
<b>1800 2605</b>	10 x 100 mm	25	<b>2,29</b>
<b>1800 2606</b>	11 x 120 mm	10	<b>2,64</b>
<b>1800 2607</b>	12 x 140 mm	10	<b>3,37</b>
<b>1800 2608</b>	13 x 160 mm	10	<b>5,60</b>

Medidas / Dimensions

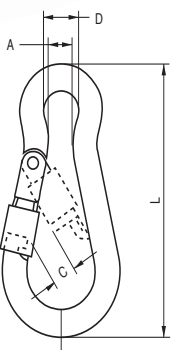

M	A	B	C	D	L	
6 x 60	7 mm	6 mm	6 mm	10 mm	60 mm	130 kg
7 x 70	8 mm	7 mm	7 mm	11 mm	70 mm	180 kg
8 x 80	9 mm	8 mm	8 mm	13 mm	80 mm	230 kg
9 x 90	10 mm	9 mm	8 mm	13 mm	90 mm	250 kg
10 x 100	11 mm	10 mm	10 mm	16 mm	100 mm	350 kg
11 x 120	12 mm	11 mm	15 mm	19 mm	120 mm	450 kg
12 x 140	14 mm	12 mm	17 mm	20 mm	140 mm	510 kg
13 x 160	16 mm	13 mm	25 mm	22 mm	160 mm	600 kg

MOSQUETÓN ALUMINIO - COLORES / MOUSQUETONS ALUMINIUM - COULEURS / ALUMINIUM SPRING HOOK - COLORS / MOSCHETTONI IN ALLUMINIO - COLORATI / MOSQUETÃO ALUMÍNIO - CORES



Cajas colores surtidos / Boite assortiment couleurs / Box of assorted colors  
 Confezione colori assortiti / Caixas cores sortidas

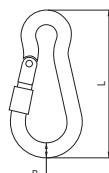

Ref	B x L		
<b>1800 2590</b>	5 x 50 mm	100	<b>0,89</b>
<b>1800 2591</b>	6 x 60 mm	50	<b>1,00</b>
<b>1800 2592</b>	7 x 70 mm	50	<b>1,23</b>
<b>1800 2593</b>	8 x 80 mm	25	<b>1,70</b>



MOSQUETÓN OVAL / MOUSQUETON / SNAP / MOSCHETTONE / MOSQUETÃO OVAL



Ref	A x B		
<b>1800 3001</b>	13 x 73 mm	50	<b>1,65</b>
<b>1800 3003</b>	16 x 78 mm	50	<b>1,93</b>
<b>1800 3006</b>	20 x 82 mm	25	<b>1,99</b>
<b>1800 3008</b>	22 x 84 mm	25	<b>2,28</b>
<b>1800 3010</b>	25 x 87 mm	20	<b>2,65</b>

MOSQUETÓN GIRATORIO NIQUELADO / MOUSQUETON TOURNANT NICKÈLE / NICKEL-PLATED ROTATORY SNAP  
MOSCHETTONE GIREVOLE NICHELATO / MOSQUETÃO DE NÍQUEL



Ref	A x B		
<b>1800 3102</b>	30 mm	200	<b>0,22</b>
<b>1800 3103</b>	40 mm	200	<b>0,29</b>
<b>1800 3104</b>	50 mm	200	<b>0,70</b>
<b>1800 3105</b>	60 mm	100	<b>1,12</b>
<b>1800 3106</b>	70 mm	100	<b>1,14</b>
<b>1800 3107</b>	80 mm	50	<b>1,27</b>
<b>1800 3108</b>	100 mm	25	<b>1,53</b>

TORNIQUETE GIRATORIO / TOURNIQUET / SHACKLE / DOPPIO ANELLO / DESTORCEDOR OLHAL/OLHAL

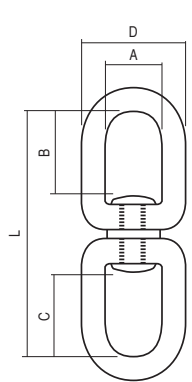

Niquelado / Nickèle / Nickel-Plated / Nichelato / Níquel

Ref	A x B		
<b>1800 2301</b>	13 x 13 mm	50	<b>1,69</b>
<b>1800 2302</b>	16 x 16 mm	50	<b>1,81</b>
<b>1800 2303</b>	20 x 20 mm	50	<b>2,14</b>
<b>1800 2304</b>	22 x 22 mm	50	<b>2,27</b>
<b>1800 2305</b>	25 x 25 mm	50	<b>2,48</b>

M	A x B	C	D	L
13x13	13 x 13 mm	13 mm	23 mm	43,5 mm
16x16	16 x 16 mm	16 mm	29 mm	52 mm
20x20	20 x 20 mm	20 mm	31 mm	61 mm
22x22	22 x 22 mm	22 mm	35 mm	67 mm
25x25	25 x 25 mm	25 mm	37 mm	68 mm

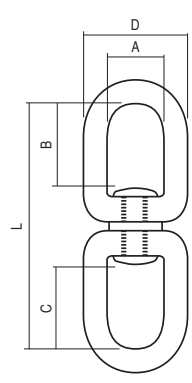

Ref	G		
<b>1800 3201</b>	6 mm	25	<b>4,93</b>
<b>1800 3202</b>	8 mm	25	<b>5,73</b>
<b>1800 3203</b>	10 mm	10	<b>8,62</b>
<b>1800 3204</b>	12 mm	5	<b>12,55</b>
<b>1800 3205</b>	16 mm	5	<b>18,49</b>
<b>1800 3206</b>	20 mm	1	<b>26,47</b>

M	A	B	C	D	L
6	19,0 mm	17,5 mm	23,0 mm	31,7 mm	65,6 mm
8	25,4 mm	20,6 mm	31,7 mm	41,3 mm	90,5 mm
10	31,7 mm	23,8 mm	38,1 mm	51,0 mm	109,5 mm
12	38,1 mm	33,3 mm	51,0 mm	63,0 mm	138,0 mm
16	44,5 mm	39,6 mm	60,7 mm	76,0 mm	166,0 mm
20	51,0 mm	44,5 mm	66,7 mm	88,0 mm	182,0 mm





POLEA SIMPLE FIJA NIQUELADA / POULIES SIMPLES FIXES NICKEL / FIXED SIMPLE PULLEYS NICKEL-PLATED  
CARRUCOLE FISSE, NICHELATE / POLIA SIMPLES FIXA DE NÍQUEL



Ref				
<b>1800 3020</b>	12 mm	3 mm	25	<b>1,16</b>
<b>1800 3021</b>	20 mm	5 mm	25	<b>1,45</b>
<b>1800 3022</b>	25 mm	6 mm	25	<b>2,36</b>
<b>1800 3023</b>	30 mm	10 mm	25	<b>3,69</b>
<b>1800 3024</b>	40 mm	10 mm	10	<b>4,43</b>

POLEA SIMPLE GIRATORIA NIQUELADA / POULIES SIMPLES ROTATIVES NICKEL / ROTARY SIMPLE PULLEYS NICKEL-PLATED  
CARRUCOLE MOBILI, NICHELATE / POLIA SIMPLES GIRATÓRIA DE NÍQUEL



Ref				
<b>1800 3025</b>	12 mm	3 mm	25	<b>1,18</b>
<b>1800 3026</b>	20 mm	5 mm	25	<b>1,48</b>
<b>1800 3027</b>	25 mm	6 mm	25	<b>2,42</b>
<b>1800 3028</b>	30 mm	10 mm	25	<b>3,76</b>
<b>1800 3029</b>	40 mm	10 mm	10	<b>4,53</b>

POLEA DOBLE FIJA NIQUELADA / POULIES DOUBLES FIXES NICKEL / FIXED DOUBLE PULLEYS NICKEL-PLATED  
CARRUCOLE FISSE DOPPIE, NICHELATE / POLIA DUPLA FIXA DE NÍQUEL



Ref				
<b>1800 3030</b>	12 mm	3 mm	25	<b>1,90</b>
<b>1800 3031</b>	20 mm	5 mm	25	<b>2,32</b>
<b>1800 3032</b>	25 mm	6 mm	25	<b>3,69</b>
<b>1800 3033</b>	30 mm	10 mm	25	<b>5,80</b>
<b>1800 3034</b>	40 mm	10 mm	10	<b>6,50</b>

POLEA DOBLE GIRATORIA NIQUELADA / POULIES DOUBLES ROTATIVES NICKEL / ROTARY DOUBLE PULLEYS NICKEL-PLATED  
CARRUCOLE MOBILI DOPPIE, NICHELATE / POLIA DUPLA GIRATÓRIA DE NÍQUEL



Ref				
<b>1800 3035</b>	12 mm	3 mm	25	<b>1,96</b>
<b>1800 3036</b>	20 mm	5 mm	25	<b>2,39</b>
<b>1800 3037</b>	25 mm	6 mm	25	<b>3,76</b>
<b>1800 3038</b>	30 mm	10 mm	25	<b>5,88</b>
<b>1800 3039</b>	40 mm	10 mm	10	<b>6,81</b>



ANILLA DE ELEVACIÓN ROSCA MACHO DIN-580 / ANNEAU DE LEVAGE MALE DIN-580 / ELEVATION MALE RING DIN-580  
GOLFARE MASCHIO DIN-580 / OLHAL DE SUSPENSÃO ROSCA MACHO DIN-580



Ref	M		
1800 1901	M-6	50	0,95
1800 1902	M-8	50	1,02
1800 1903	M-10	50	1,63
1800 1904	M-12	25	2,14
1800 1905	M-14	10	3,68
1800 1906	M-16	10	3,68
1800 1907	M-18	10	5,33
1800 1908	M-20	10	5,25
1800 1909	M-22	5	10,08
1800 1910	M-24	1	10,08
1800 1911	M-27	1	20,85
1800 1912	M-30	1	24,51

Medidas / Dimensions

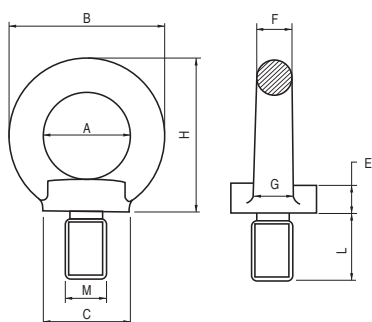

M	A	B	C	E	F	G	H	L	
6	20 mm	36 mm	20 mm	6 mm	8 mm	10 mm	36 mm	13,0 mm	90 kg
8	20 mm	36 mm	20 mm	6 mm	8 mm	10 mm	36 mm	13,0 mm	140 kg
10	25 mm	45 mm	25 mm	8 mm	10 mm	12 mm	45 mm	17,0 mm	230 kg
12	30 mm	54 mm	30 mm	10 mm	12 mm	14 mm	53 mm	20,5 mm	340 kg
14	30 mm	54 mm	30 mm	10 mm	12 mm	14 mm	53 mm	20,5 mm	500 kg
16	35 mm	63 mm	35 mm	12 mm	14 mm	16 mm	62 mm	27,0 mm	700 kg
18	35 mm	63 mm	35 mm	12 mm	14 mm	16 mm	62 mm	27,0 mm	930 kg
20	40 mm	72 mm	40 mm	14 mm	16 mm	19 mm	71 mm	30,0 mm	1.200 kg
22	40 mm	72 mm	40 mm	14 mm	16 mm	19 mm	71 mm	30,0 mm	1.500 kg
24	50 mm	90 mm	50 mm	18 mm	20 mm	24 mm	90 mm	36,0 mm	1.800 kg
27	54 mm	98 mm	62 mm	20 mm	22 mm	26 mm	99 mm	40,0 mm	2.500 kg
30	60 mm	108 mm	65 mm	22 mm	24 mm	28 mm	109 mm	45,0 mm	3.600 kg

ANILLA DE ELEVACIÓN ROSCA HEMBRA DIN-582 / ANNEAU DE LEVAGE FEMELLE DIN-582 / ELEVATION FEMALE RING DIN-582  
ANELLO SOLLEVAMENTO FEMMINA DIN-582 / OLHAL DE SUSPENSÃO ROSCA FEMEA DIN-582



Ref	M		
1800 2001	M-6	50	0,95
1800 2002	M-8	50	1,02
1800 2003	M-10	50	1,63
1800 2004	M-12	25	2,14
1800 2005	M-14	10	3,68
1800 2006	M-16	10	3,69
1800 2007	M-18	10	5,33
1800 2008	M-20	10	5,38
1800 2009	M-22	1	9,86
1800 2010	M-24	1	10,10
1800 2011	M-27	1	20,85
1800 2012	M-30	1	24,51

Medidas / Dimensions

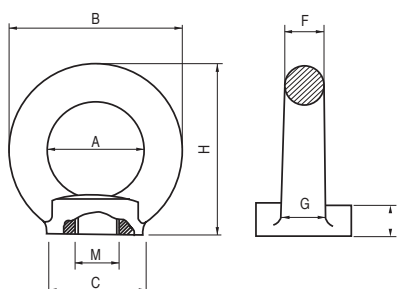

M	A	B	C	E	F	G	H	L	
6	20 mm	36 mm	20 mm	8,5 mm	8 mm	10 mm	36 mm	13,0	90 kg
8	20 mm	36 mm	20 mm	8,5 mm	8 mm	10 mm	36 mm	13,0	140 kg
10	25 mm	45 mm	25 mm	10,0 mm	10 mm	12 mm	45 mm	17,0	230 kg
12	30 mm	54 mm	30 mm	11,0 mm	12 mm	14 mm	53 mm	20,5	340 kg
14	30 mm	54 mm	30 mm	11,0 mm	12 mm	14 mm	53 mm	20,5	500 kg
16	35 mm	63 mm	35 mm	13,0 mm	14 mm	16 mm	62 mm	27,0	700 kg
18	35 mm	63 mm	35 mm	13,0 mm	14 mm	16 mm	62 mm	27,0	930 kg
20	40 mm	72 mm	40 mm	16,0 mm	16 mm	19 mm	71 mm	30,0	1.200 kg
22	40 mm	72 mm	40 mm	16,0 mm	16 mm	19 mm	71 mm	30,0	1.500 kg
24	50 mm	90 mm	50 mm	20,0 mm	20 mm	24 mm	90 mm	36,0	1.800 kg
27	54 mm	98 mm	62 mm	20,0 mm	22 mm	26 mm	99 mm	40,0	2.500 kg
30	60 mm	108 mm	65 mm	25,0 mm	24 mm	28 mm	109 mm	45,0	3.600 kg



GRILLETE RECTO GALVANIZADO / MAILLE DROITE ZINGUÉ / ZINC STRAIGHT SHACKLE / GRILLO DRITTO ZINCATO / MANILHA RETA ZINCADA



Ref	Ø	Ø		
1800 2201	5 mm	3/16"	100	<b>0,42</b>
1800 2202	6 mm	1/4"	100	<b>0,46</b>
1800 2203	8 mm	5/16"	50	<b>0,68</b>
1800 2204	10 mm	3/8"	50	<b>0,92</b>
1800 2205	11 mm	7/16"	25	<b>1,28</b>
1800 2206	12 mm	1/2"	25	<b>1,47</b>
1800 2207	14 mm	9/16"	10	<b>2,49</b>
1800 2208	16 mm	5/8"	10	<b>3,31</b>
1800 2209	18 mm	11/16"	10	<b>5,26</b>
1800 2210	20 mm	3/4"	5	<b>5,66</b>
1800 2211	22 mm	7/8"	5	<b>7,66</b>
1800 2212	25 mm	1"	1	<b>11,50</b>
1800 2213	28 mm	1" 1/8	1	<b>25,60</b>
1800 2214	32 mm	1" 1/4	1	<b>41,50</b>
1800 2215	36 mm	1" 7/16	1	<b>42,19</b>
1800 2216	38 mm	1" 1/2	1	<b>50,35</b>
1800 2217	42 mm	1" 11/16	1	<b>84,24</b>
1800 2218	50 mm	2"	1	<b>139,02</b>

Medidas / Dimensions

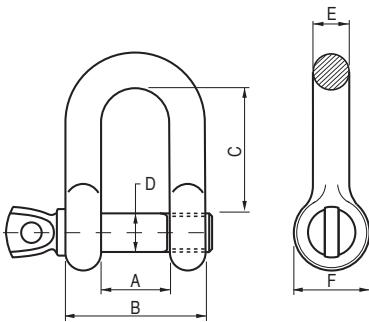

M	A	B	C	D	E	F	max
5	10 mm	20 mm	20 mm	5 mm	5 mm	11 mm	80 kg
6	13 mm	25 mm	24 mm	6 mm	6 mm	14 mm	100 kg
8	16 mm	32 mm	32 mm	8 mm	8 mm	18 mm	200 kg
10	19 mm	39 mm	38 mm	10 mm	10 mm	20 mm	320 kg
11	22 mm	44 mm	44 mm	11 mm	11 mm	24 mm	400 kg
12	25 mm	50 mm	50 mm	12 mm	12 mm	28 mm	520 kg
14	28 mm	56 mm	56 mm	14 mm	14 mm	30 mm	650 kg
16	32 mm	64 mm	64 mm	16 mm	16 mm	33 mm	800 kg
18	32 mm	72 mm	70 mm	18 mm	18 mm	37 mm	1.000 kg
20	38 mm	78 mm	76 mm	20 mm	20 mm	40 mm	1.100 kg
22	44 mm	88 mm	88 mm	22 mm	22 mm	50 mm	1.500 kg
25	50 mm	101 mm	100 mm	25 mm	25 mm	57 mm	2.100 kg
28	57 mm	114 mm	114 mm	28 mm	28 mm	68 mm	3.000 kg
32	64 mm	128 mm	128 mm	32 mm	32 mm	73 mm	3.500 kg
36	72 mm	144 mm	140 mm	36 mm	36 mm	80 mm	4.200 kg
38	76 mm	152 mm	152 mm	38 mm	38 mm	85 mm	5.000 kg
42	84 mm	168 mm	166 mm	42 mm	42 mm	90 mm	6.000 kg
50	102 mm	202 mm	200 mm	50 mm	50 mm	108 mm	8.000 kg

GRILLETE LIRA ALTA RESISTENCIA GALVANIZADO / MAILLE DROITE HAUTE RESISTANCE / HIGH STRENGTH STRAIGHT SHACKLE  
GRILLO A CETRA ZINCATO, ALTA RESISTENZA / MANILHA CURVA ALTA RESISTÊNCIA ZINCADA



ES Cuerpo y bulón de acero aleado de alta resistencia. Norma: EN 13889 y cumple con US Fed. Spec. RR-C-271.  
FR Corps et boulon en acier de haute résistance. Norme: EN 13889 en association avec FEC Spec. RR-C-271.  
EN Body and screw made from high resistance alloy steel. Norm: EN 13889 and complies with US Fed. Spec. RR-C-271.  
IT Corpo e perno in lega d'acciaio ad alta resistenza. Norma: EN 13889, conforme con U.S. Fed. Spec. RR-C-271.  
PT Corpo e parafuso feitos de liga de aço de alta resistência. Norma: EN 13889 e está em conformidade com US A Fed. Spec. RR-C-271.

Medidas / Dimensions

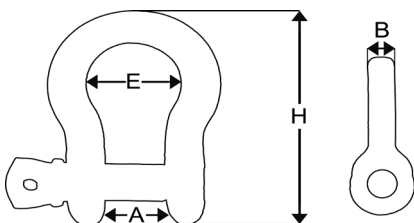

Ref	Ø	Ø	A	B	E	H	max		
1800 2250	13 mm	1/2"	22 mm	16 mm	33 mm	83 mm	2.000 kg	1	<b>7,23</b>
1800 2251	16 mm	5/8"	27 mm	19 mm	43 mm	107 mm	3.250 kg	1	<b>12,71</b>
1800 2252	18 mm	3/4"	32 mm	22 mm	51 mm	127 mm	4.750 kg	1	<b>18,89</b>
1800 2253	22 mm	7/8"	36 mm	25 mm	58 mm	146 mm	6.500 kg	1	<b>28,14</b>
1800 2254	26 mm	1"	43 mm	29 mm	68 mm	165 mm	8.500 kg	1	<b>38,79</b>
1800 2255	29 mm	1" 1/8	46 mm	32 mm	74 mm	186 mm	9.500 kg	1	<b>59,31</b>
1800 2256	32 mm	1" 1/4	51 mm	35 mm	82 mm	206 mm	12.000 kg	1	<b>82,94</b>
1800 2257	38 mm	1" 1/2	60 mm	41 mm	98 mm	251 mm	17.000 kg	1	<b>111,69</b>



TENSOR ANILLA - ANILLA ZINCADO DIN-1480 / TENDEUR MAILLE-MAILLE DIN-1480 / ZINC STURT RING-RING DIN-1480  
TENDITORE A DUE OCCHI DIN-1480 / ESTICADOR OLHAL ZINCADO DIN-1480



Ref	Ø	Ø		
<b>1800 1401</b>	5 mm	3/16"	50	<b>1,41</b>
<b>1800 1402</b>	6 mm	1/4"	50	<b>1,81</b>
<b>1800 1403</b>	8 mm	5/16"	25	<b>2,49</b>
<b>1800 1404</b>	10 mm	3/8"	25	<b>3,53</b>
<b>1800 1405</b>	12 mm	1/2"	10	<b>5,29</b>
<b>1800 1406</b>	14 mm	9/16"	10	<b>7,14</b>
<b>1800 1407</b>	16 mm	5/8"	10	<b>9,13</b>
<b>1800 1409</b>	20 mm	3/4"	1	<b>18,39</b>
<b>1800 1410</b>	22 mm	7/8"	1	<b>25,18</b>
<b>1800 1411</b>	24 mm	1"	1	<b>34,22</b>

Medidas / Dimensions

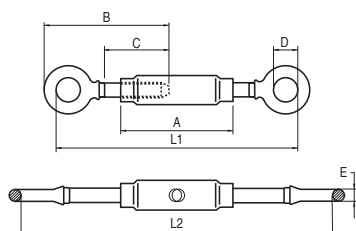

M	A	B	C	D	E	F	L1	L2	max
5	9,0 mm	79 mm	9 mm	40 mm	8 mm	4,0 mm	110 mm	183 mm	40 kg
6	10,0 mm	88 mm	74 mm	50 mm	10 mm	4,0 mm	140 mm	222 mm	225 kg
8	12,0 mm	110 mm	80 mm	52 mm	11 mm	5,0 mm	156 mm	252 mm	410 kg
10	15,0 mm	130 mm	97 mm	60 mm	14 mm	6,5 mm	191 mm	301 mm	650 kg
12	18,0 mm	140 mm	106 mm	67 mm	17 mm	8,0 mm	202 mm	326 mm	930 kg
14	20,0 mm	170 mm	126 mm	83 mm	18 mm	8,5 mm	239 mm	393 mm	1.330 kg
16	22,5 mm	190 mm	160 mm	97 mm	23 mm	13,0 mm	294 mm	470 mm	1.770 kg
20	30,0 mm	220 mm	190 mm	116 mm	25 mm	14,0 mm	352 mm	554 mm	2.700 kg
22	33,0 mm	242 mm	200 mm	120 mm	30 mm	16,0 mm	368 mm	588 mm	3.300 kg
24	39,0 mm	255 mm	240 mm	125 mm	34 mm	17,0 mm	391 mm	621 mm	3.920 kg

TENSOR VARILLAS PARA SOLDAR DIN-1480 / TENDEUR À TIGE À SOUDER DIN-1480 / BAR STRUT FOR WELDING DIN-1480  
TENDITORE A SALDARE, A 2 TRONCHI / ESTICADOR HASTES PARA SOLDAR DIN-1480



Ref	Ø	Ø		
<b>1800 1802</b>	10 mm	3/8 "	10	<b>5,08</b>
<b>1800 1803</b>	12 mm	1/2 "	10	<b>6,20</b>
<b>1800 1804</b>	14 mm	9/16 "	10	<b>8,08</b>
<b>1800 1805</b>	16 mm	5/8 "	1	<b>13,20</b>
<b>1800 1806</b>	20 mm	3/4 "	1	<b>24,26</b>
<b>1800 1807</b>	24 mm	1"	1	<b>32,82</b>
<b>1800 1808</b>	27 mm	1" 1/16	1	<b>54,70</b>
<b>1800 1809</b>	30 mm	1" 1/4	1	<b>62,11</b>

Medidas / Dimensions

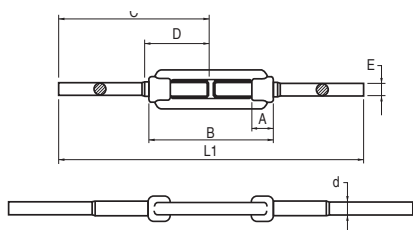

M	A	B	C	D	E	L1	L2	max
10	18 mm	125 mm	150 mm	75 mm	8,80 mm	300 mm	407 mm	650 kg
12	21 mm	125 mm	150 mm	75 mm	10,70 mm	300 mm	407 mm	930 kg
14	23 mm	140 mm	180 mm	90 mm	12,70 mm	360 mm	477 mm	1.320 kg
16	27 mm	170 mm	200 mm	100 mm	14,50 mm	400 mm	543 mm	1.770 kg
20	34 mm	200 mm	220 mm	120 mm	18,70 mm	440 mm	606 mm	2.700 kg
24	39 mm	255 mm	260 mm	150 mm	22,50 mm	520 mm	736 mm	3.920 kg
27	45 mm	255 mm	260 mm	160 mm	24,80 mm	520 mm	736 mm	4.950 kg
30	45 mm	255 mm	260 mm	175 mm	27,50 mm	520 mm	736 mm	6.250 kg



TENSOR GANCHO - ANILLA ZINCADO DIN-1480 / TENDEUR CROCHET-MAILLE DIN-1480 / ZINC STRUT HOOK-RING DIN-1480  
TENDITORE OCCHIO-GANCIO DIN-1480 / ESTICADOR GANCHO/OLHAL ZINCADO DIN-1480



Ref	Ø	Ø	📦	📦
<b>1800 1301</b>	5 mm	3/16"	50	<b>1,37</b>
<b>1800 1302</b>	6 mm	1/4"	50	<b>1,86</b>
<b>1800 1303</b>	8 mm	5/16"	25	<b>2,25</b>
<b>1800 1304</b>	10 mm	3/8"	25	<b>3,57</b>
<b>1800 1305</b>	12 mm	1/2"	5	<b>4,62</b>
<b>1800 1306</b>	14 mm	9/16"	1	<b>7,00</b>
<b>1800 1307</b>	16 mm	5/8"	1	<b>10,62</b>
<b>1800 1309</b>	20 mm	3/4"	1	<b>15,25</b>
<b>1800 1310</b>	22 mm	7/8"	1	<b>19,21</b>
<b>1800 1311</b>	24 mm	1"	1	<b>28,47</b>
<b>1800 1312</b>	27 mm	1" 1/16	1	<b>62,33</b>
<b>1800 1313</b>	30 mm	1" 1/4	1	<b>97,82</b>
<b>1800 1314</b>	32 mm	1" 5/16	1	<b>123,54</b>
<b>1800 1315</b>	36 mm	1" 1/2	1	<b>175,40</b>

Medidas / Dimensions

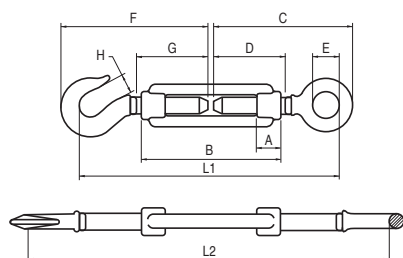

M	A	B	C	D	E	F	G	H	L1	L2	📦 max
5	9,0 mm	79 mm	59 mm	40 mm	8 mm	62 mm	40 mm	6,0 mm	112 mm	181 mm	50 kg
6	10,0 mm	88 mm	74 mm	50 mm	10 mm	76 mm	50 mm	8,5 mm	140 mm	217 mm	75 kg
8	12,0 mm	110 mm	80 mm	52 mm	11 mm	89 mm	52 mm	10,0 mm	161 mm	253 mm	165 kg
10	15,0 mm	130 mm	97 mm	60 mm	14 mm	103 mm	62 mm	12,0 mm	192 mm	303 mm	235 kg
12	18,0 mm	140 mm	106 mm	67 mm	17 mm	121 mm	65 mm	16,0 mm	215 mm	330 mm	320 kg
14	20,0 mm	170 mm	126 mm	83 mm	18 mm	144 mm	82 mm	16,0 mm	251 mm	399 mm	420 kg
16	22,5 mm	190 mm	160 mm	97 mm	23 mm	172 mm	105 mm	16,5 mm	296 mm	466 mm	530 kg
20	30,0 mm	220 mm	190 mm	116 mm	25 mm	185 mm	110 mm	17,5 mm	339 mm	533 mm	730 kg
22	33,0 mm	242 mm	200 mm	120 mm	30 mm	216 mm	125 mm	23,0 mm	379 mm	585 mm	1.120 kg
24	39,0 mm	255 mm	210 mm	125 mm	34 mm	225 mm	135 mm	23,0 mm	396 mm	610 mm	1.550 kg
27	43,0 mm	300 mm	236 mm	150 mm	34 mm	250 mm	135 mm	29,0 mm	452 mm	696 mm	1.870 kg
30	45,0 mm	255 mm	240 mm	150 mm	38 mm	250 mm	145 mm	29,0 mm	441 mm	651 mm	2.240 kg
33	48,0 mm	300 mm	242 mm	150 mm	39 mm	250 mm	145 mm	29,0 mm	457 mm	693 mm	2.850 kg
36	55,0 mm	295 mm	276 mm	160 mm	48 mm	284 mm	170 mm	30,0 mm	502 mm	749 mm	3.530 kg

TENSOR GANCHO - GANCHO ZINCADO DIN-1480 / TENDEUR DE CÂBLE - CROCHET ZINGUÉ / ZINC STRUT HOOK-HOOK DIN-1480  
TENDITORE GANCIO-GANCIO DIN-1480 / ESTICADOR GANCHO/GANCHO ZINCADO DIN-1480



Ref	Ø	Ø	📦	📦
<b>1800 1701</b>	5 mm	3/16"	50	<b>1,54</b>
<b>1800 1702</b>	6 mm	1/4"	50	<b>1,92</b>
<b>1800 1703</b>	8 mm	5/16"	25	<b>2,63</b>
<b>1800 1704</b>	10 mm	3/8"	25	<b>3,70</b>
<b>1800 1705</b>	12 mm	1/2"	10	<b>5,37</b>
<b>1800 1706</b>	14 mm	9/16"	1	<b>7,67</b>
<b>1800 1707</b>	16 mm	5/8"	1	<b>10,35</b>
<b>1800 1709</b>	20 mm	3/4"	1	<b>18,39</b>
<b>1800 1711</b>	24 mm	1"	1	<b>39,55</b>
<b>1800 1712</b>	27 mm	1" 1/16	1	<b>63,27</b>

Medidas / Dimensions

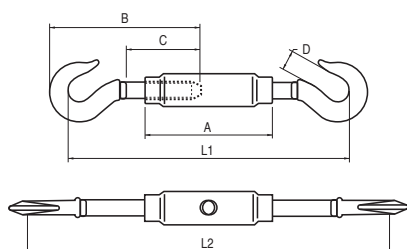

M	A	B	C	D	E	L1	L2	📦 max
5	9,0 mm	79 mm	62 mm	40 mm	6,0 mm	114 mm	180 mm	50 kg
6	10,0 mm	88 mm	76 mm	50 mm	8,5 mm	140 mm	212 mm	75 kg
8	12,0 mm	110 mm	89 mm	52 mm	10,0 mm	165 mm	255 mm	165 kg
10	15,0 mm	130 mm	103 mm	62 mm	12,0 mm	192 mm	305 mm	235 kg
12	18,0 mm	140 mm	121 mm	65 mm	16,0 mm	228 mm	335 mm	320 kg
14	20,0 mm	170 mm	144 mm	82 mm	16,0 mm	262 mm	406 mm	420 kg
16	22,5 mm	190 mm	172 mm	105 mm	16,5 mm	298 mm	463 mm	530 kg
20	30,0 mm	220 mm	185 mm	110 mm	17,5 mm	325 mm	512 mm	730 kg
24	39,0 mm	255 mm	225 mm	135 mm	23,0 mm	400 mm	600 mm	1.550 kg
27	43,0 mm	300 mm	250 mm	135 mm	29,0 mm	470 mm	685 mm	1.870 kg





TENSOR TUBULAR GANCHO - ANILLA / TENDEUR TUBULAIRE CROCHET-MAILLE / TUBULAR STRUT HOOK-RING  
TENDITORE TUBOLARE GANCIO-ANELLO / ESTICADOR TUBULAR GANCHO/OLHAL



Medidas / Dimensions

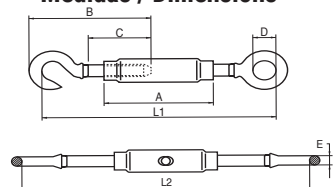

Ref	∅		
<b>1800 1602</b>	8 mm	10	<b>12,32</b>
<b>1800 1603</b>	10 mm	10	<b>14,95</b>
<b>1800 1604</b>	12 mm	5	<b>19,57</b>
<b>1800 1605</b>	16 mm	1	<b>28,31</b>
<b>1800 1606</b>	20 mm	1	<b>45,15</b>

M	A	B	C	D	E	F	G	L1	L2	
8	110 mm	80 mm	52 mm	11 mm	89 mm	52 mm	10,0 mm	161 mm	250 mm	165 kg
10	125 mm	97 mm	60 mm	14 mm	103 mm	62 mm	12,0 mm	187 mm	293 mm	235 kg
12	125 mm	106 mm	67 mm	17 mm	121 mm	65 mm	16,0 mm	208 mm	313 mm	320 kg
16	170 mm	160 mm	97 mm	23 mm	172 mm	105 mm	16,5 mm	299 mm	440 mm	530 kg
20	200 mm	190 mm	116 mm	25 mm	185 mm	110 mm	17,5 mm	341 mm	509 mm	730 kg

TENSOR HORQUILLA - HORQUILLA ZINCADO DIN-1480 / TENDEUR TUBULAIRE FOURCHETTE-FOURCHETTE / ZINC STRUT YOKE-YOKE DIN-1480  
TENDITORE FORCELLA-FORCELLA DIN-1480 / ESTICADOR MANILHA ZINCADO DIN-1480

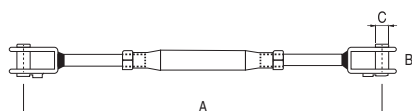

Ref	∅	∅	A	B	C			
<b>1800 1502</b>	8 mm	5/16"	190 mm	12,0 mm	6,0 mm	440 kg	10	<b>11,33</b>
<b>1800 1503</b>	10 mm	3/8"	210 mm	11,5 mm	8,0 mm	440 kg	5	<b>12,36</b>
<b>1800 1504</b>	12 mm	1/2"	295 mm	16,0 mm	12,0 mm	600 kg	5	<b>18,73</b>
<b>1800 1505</b>	16 mm	5/8"	380 mm	22,0 mm	15,0 mm	800 kg	1	<b>28,32</b>
<b>1800 1506</b>	20 mm	3/4"	375 mm	26,0 mm	15,5 mm	1.650 kg	1	<b>48,69</b>
<b>1800 1507</b>	24 mm	1"	460 mm	33,0 mm	21,5 mm	2.600 kg	1	<b>87,68</b>

ACCESORIOS INOX A-2 / ACCESSOIRES INOX A-2 / ACCESSORIES INOX A-2  
ACCESSORI INOX A-2 / ACESSÓRIOS INOX A-2

SUJETACABLES DIN-741 INOX A-2 / SERRE-CÂBLES DIN-741 INOX A-2 / STAINLESS STEEL A-2 WIRE ROPE CLIP DIN-741  
FERMACAVO DIN 741 INOX A-2 / CERRA CABOS DIN-741 INOX A-2 / CERRA CABOS INOX A-2

INOX A-2



Ref		
<b>1800 5001</b>	INOX M-3	20
<b>1800 5002</b>	INOX M-5	20
<b>1800 5003</b>	INOX M-6	20
<b>1800 5004</b>	INOX M-8	10
<b>1800 5005</b>	INOX M-10	10
<b>1800 5006</b>	INOX M-12	5
<b>1800 5007</b>	INOX M-14	5
<b>1800 5008</b>	INOX M-16	5
<b>1800 5010</b>	INOX M-20	5

Rogamos consulten precios. / Veuillez nous consulter pour le tarif actuel. / Please, consult the prices. / Per favore consultare il prezzo. / Por favor, consultem os preços

SUJETACABLES PLANOS SIMPLE INOX A-2 / SERRE-CÂBLES SIMPLE INOX A-2 / ST. STEEL A-2 SIMPLE FLAT WIRE ROPE CLIP  
FERMACAVO PIANO SEMPLICE INOX A-2 / CERRA CABOS PLANO SIMPLES INOX A-2

INOX A-2



Ref		
<b>1800 5101</b>	INOX M-2	10
<b>1800 5102</b>	INOX M-3	10
<b>1800 5103</b>	INOX M-4	10
<b>1800 5104</b>	INOX M-5	10
<b>1800 5105</b>	INOX M-6	5
<b>1800 5106</b>	INOX M-8	5
<b>1800 5107</b>	INOX M-10	5

Rogamos consulten precios. / Veuillez nous consulter pour le tarif actuel. / Please, consult the prices. / Per favore consultare il prezzo. / Por favor, consultem os preços



SUJETACABLES PLANOS DOBLE INOX A-2 / SERRE-CÂBLES PLAT INOX A-2 / STAINLESS STEEL A-2 FLAT DOUBLE WIRE ROPE CLIP  
FERMACAVO DOPPIO INOX A-2 / CERRA CABOS PLANO DUPLO INOX A-2

**INOX A-2**

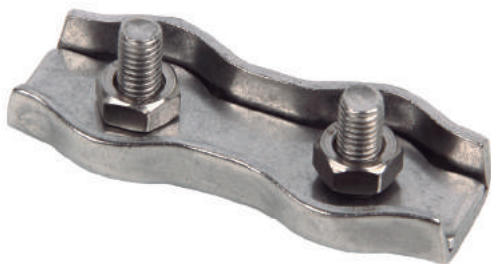

Ref		
1800 5201	INOX M-2	10
1800 5202	INOX M-3	10
1800 5203	INOX M-4	10
1800 5204	INOX M-5	10
1800 5205	INOX M-6	5
1800 5206	INOX M-8	5
1800 5207	INOX M-10	5

Rogamos consulten precios. / Veuillez nous consulter pour le tarif actuel. / Please, consult the prices. / Per favore consultare il prezzo. / Por favor, consultem os preços

GUARDACABOS DIN-6899A INOX A-2 / PASSE-CÂBLES DIN-6899A INOX A-2 / STAINLESS STEEL A-2 THIMBLE DIN-6899A  
REDANCE DIN-6899A INOX A-2 / SAPATILHOS DIN-6899A INOX A-2

**INOX A-2**



Ref		
1800 5301	INOX M-3	10
1800 5302	INOX M-4	10
1800 5303	INOX M-5	10
1800 5304	INOX M-6	10
1800 5305	INOX M-8	10
1800 5306	INOX M-10	5
1800 5307	INOX M-12	5
1800 5308	INOX M-14	5
1800 5309	INOX M-16	5
1800 5310	INOX M-18	1
1800 5311	INOX M-20	1

Rogamos consulten precios. / Veuillez nous consulter pour le tarif actuel. / Please, consult the prices. / Per favore consultare il prezzo. / Por favor, consultem os preços

MOSQUETÓN BOMBERO INOX A-2 / MOUSQUETON POMPIER INOX A-2 / STAINLESS STEEL A-2 SPRING HOOK  
MOSCHETTONE INOX A-2 / MOSQUETÃO BOMBEIRO INOX A-2

**INOX A-2**



Ref		
1800 5701	INOX M-4X40	20
1800 5702	INOX M-5X50	20
1800 5703	INOX M-6X60	20
1800 5704	INOX M-7X70	10
1800 5705	INOX M-8X80	10
1800 5706	INOX M-10X100	10
1800 5707	INOX M-11X120	1
1800 5708	INOX M-12X140	1

Rogamos consulten precios. / Veuillez nous consulter pour le tarif actuel. / Please, consult the prices. / Per favore consultare il prezzo. / Por favor, consultem os preços

TENSOR GANCHO-ANILLA INOX A-2 / TENDEUR CROCHET-ANNEAU INOX A-2 / STRUT YOKE-RING INOX A-2  
TENSORE GANCIO-ANELLO INOX A-2 / ESTICADOR GANCHO-OLHAL INOX A-2

**INOX A-2**



Ref		
1800 5401	INOX M-5	10
1800 5402	INOX M-6	10
1800 5403	INOX M-8	10
1800 5404	INOX M-10	5
1800 5405	INOX M-12	1
1800 5406	INOX M-16	1
1800 5407	INOX M-20	1

Rogamos consulten precios. / Veuillez nous consulter pour le tarif actuel. / Please, consult the prices. / Per favore consultare il prezzo. / Por favor, consultem os preços



TENSOR TUBULAR HORQUILLA - HORQUILLA ACERO INOX A-2 / TENDEUR TUBULAIRE FOURCHETTE-FOURCHETTE ACIER INOX A-2  
STAINLESS STEEL A-2 TUBULAR STRUT STAINLESS STEEL YOKE / TENDITORE TUBOLARE FORCELLA-FORCELLA INOX A-2  
ESTICADOR TUBULAR MANILHA - MANILHA AÇO INOX A-2

**INOX A-2**



Ref		
1800 5502	INOX M-5	1
1800 5503	INOX M-6	1
1800 5504	INOX M-8	1
1800 5505	INOX M-10	1
1800 5506	INOX M-12	1
1800 5507	INOX M-14	1
1800 5508	INOX M-16	1
1800 5509	INOX M-20	1

Rogamos consulten precios. / Veuillez nous consulter pour le tarif actuel. / Please, consult the prices. / Per favore consultare il prezzo. / Por favor, consultem os preços

ANILLA DE ELEVACIÓN MACHO DIN-580 INOX A-2 / ANNEAU DE LEVAGE MALE DIN 580 INOX A2 / STAINLESS STEEL A-2 ELEVATION MALE RING DIN-580  
GOLFARE MASCHIO DIN-580 INOX A2 / OLHAL DE SUSPENSÃO MACHO DIN-580 INOX A-2

**INOX A-2**



Ref		
1800 5801	INOX M-6	5
1800 5802	INOX M-8	5
1800 5803	INOX M-10	5
1800 5804	INOX M-12	5
1800 5806	INOX M-16	1
1800 5808	INOX M-20	1

Rogamos consulten precios. / Veuillez nous consulter pour le tarif actuel. / Please, consult the prices. / Per favore consultare il prezzo. / Por favor, consultem os preços

ANILLA DE ELEVACIÓN HEMBRA DIN-582 INOX A-2 / ANNEAU DE LEVAGE FEMELLE DIN 582 INOX A2 / STAINLESS STEEL A-2 ELEVATION FEMALE RING DIN-582  
GOLFARE FEMMINA DIN-582 INOX A2 / OLHAL DE SUSPENSÃO FÊMEA DIN-582 INOX A-2

**INOX A-2**



Ref		
1800 5901	INOX M-6	5
1800 5902	INOX M-8	5
1800 5903	INOX M-10	5
1800 5904	INOX M-12	5
1800 5906	INOX M-16	1
1800 5908	INOX M-20	1

Rogamos consulten precios. / Veuillez nous consulter pour le tarif actuel. / Please, consult the prices. / Per favore consultare il prezzo. / Por favor, consultem os preços

GRILLETE RECTO INOX A-2 / MAILLE DROITE INOX A-2 / STAINLESS STEEL A-2 STRAIGHT SHACKLE  
GRILLO DRITTO INOX A-2 / MANILHA RETA INOX A-2

**INOX A-2**



Ref		
1800 5601	INOX M-4	10
1800 5602	INOX M-5	10
1800 5603	INOX M-6	10
1800 5604	INOX M-8	10
1800 5605	INOX M-10	5
1800 5606	INOX M-12	5
1800 5608	INOX M-16	5
1800 5609	INOX M-19	1

Rogamos consulten precios. / Veuillez nous consulter pour le tarif actuel. / Please, consult the prices. / Per favore consultare il prezzo. / Por favor, consultem os preços



PULPO CADENA 8MM G°80 2 RAMALES Y 4 RAMALES / SUPPORT CHAINE 8MM G°80 2 BRANCHES ET 4 BRANCHES  
CHAIN STRAPS 8MM G°80 - 2 & 4 STRAPS / TIRANTI A CATENA GRADO 80 A 2 E 4 BRACCI / LINGA DE CORRENTE 8MM G°80 2 RAMAIS E 4 RAMAIS

CE  
G 80





ES Para el mercado de las eslingas conviene indicar la carga máxima de utilización en kg, por debajo de 1 Tn. Unidades de medidas en kg. Estos valores están catalogados en la hipótesis de que la carga sea simétrica. En caso de carga asimétrica, se debe limitar la carga a la mitad de la carga máxima de utilización.



FR Pour le marché des élingues, il convient d'indiquer la charge maximale d'utilisation en kg, en dessous d'1 Tn. Unités de mesures en kg. Ces valeurs sont valables si la charge est symétrique. En cas de charge asymétrique, il faut limiter la charge à la moitié de la charge maximale d'utilisation.







EN Always there is mentioned the maximum load weight in kg under the sign of 1 Tn. Measurement units are in kg. Those numbers are used, following the fact that the load is symmetrical. In case that the load is asymmetric, it is recommended to use only half of the maximum load weight.

IT Per il mercato delle cinghie conviene indicare il carico massimo di utilizzo in kg, per valori inferiori ad 1t. Questi valori sono catalogati considerando il carico come simmetrico. In caso di asimmetria, si deve limitare il carico alla metà del carico massimo di utilizzo.

PT Sempre tem que estar mencionado o peso máximo de carga em kg sob o sinal de 1 Tn. Unidades de medição em kg. Estes números são utilizados, na sequência do facto de que a carga é simétrica. No caso em que a carga é assimétrica, é recomendado o uso de apenas metade do peso da carga máxima.

Ref	∅	↔	 (0-45°)		
1800 3501	8 mm	2 m	2.800 kg	1	<b>160,75</b>
1800 3502	8 mm	3 m	2.800 kg	1	<b>199,82</b>
1800 3503	8 mm	4 m	2.800 kg	1	<b>239,38</b>
1800 3504	8 mm	5 m	2.800 kg	1	<b>335,15</b>
1800 3505	8 mm	6 m	2.800 kg	1	<b>316,98</b>

Ref	∅	↔	 (0-45°)		
1800 3510	8 mm	2 m	4.250 kg	1	<b>336,35</b>
1800 3511	8 mm	3 m	4.250 kg	1	<b>414,46</b>
1800 3512	8 mm	4 m	4.250 kg	1	<b>492,58</b>
1800 3513	8 mm	5 m	4.250 kg	1	<b>684,50</b>
1800 3514	8 mm	6 m	4.250 kg	1	<b>648,81</b>

∅			 (0-45°)	 (45-60°)	 (0-45°)	 (45-60°)
6 mm	1.120 kg	900 kg	1.600 kg	1.120 kg	2.360 kg	1.700 kg
7 mm	1.500 kg	1.250 kg	2.120 kg	1.500 kg	3.150 kg	2.240 kg
8 mm	2.000 kg	1.600 kg	2.800 kg	2.000 kg	4.250 kg	3.000 kg
10 mm	3.150 kg	2.500 kg	4.250 kg	3.150 kg	6.700 kg	4.750 kg
13 mm	5.300 kg	4.250 kg	7.500 kg	5.300 kg	11.200 kg	8.000 kg
16 mm	8.000 kg	6.300 kg	11.200 kg	8.000 kg	17.000 kg	11.800 kg
19 mm	10.000 kg	8.000 kg	14.000 kg	10.000 kg	21.200 kg	15.000 kg

ANILLA SIMPLE PARA CADENA 1 Y 2 RAMALES / ANNEAU SIMPLE POUR CHAINE 1 ET 2 BRINDS / SINGLE RING FOR CHAINS 1&2 STRANDS  
ANELLO SEMPLICE PER CATENA DA 1 E 2 BRACCIA / ELO SIMPLIS PARA COREENTE 1 E 2 RAMAIS

CE  
G 80



ES Para pulpos de cadena de 1 y 2 ramales EN 818-4. Para pulpos de cable de 1 y 2 ramales EN 13414-1.

FR Pour des supports de chaîne de 1 et 2 branches EN 818-4. Pour des supports de câble de 1 et 2 branches EN 13414-1.





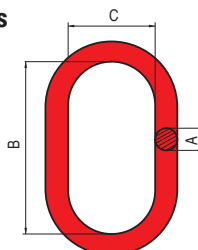

EN For chain strap kits of 1 or 2 straps EN 818-4. For cable strap kits of 1 or 2 straps EN 13414-1.

IT Per tiranti a catena da 1 e 2 braccia EN 818-4. Per tiranti a cavo da 1 e 2 braccia EN 13414-1.

PT Para kits de lingas de corrente de 1 e 2 ramaes EN 818-4. Para kits de lingas de corrente de 1 e 2 ramaes EN 13414-1.

Medidas  
Dimensions



Ref	∅	A	B	C		 (0-45°)	 max			
1800 4010	A-13	13 mm	110 mm	60 mm	6/7-8	6-8	1.600 kg	0,3 kg	1	<b>15,34</b>
1800 4011	A-16	16 mm	110 mm	60 mm	8-8	7-8	2.120 kg	0,5 kg	1	<b>18,56</b>
1800 4012	A-18	18 mm	135 mm	75 mm	10-8	8-8	3.150 kg	0,8 kg	1	<b>22,55</b>
1800 4013	A-22	22 mm	160 mm	90 mm	13-8	10-8	5.300 kg	1,6 kg	1	<b>34,42</b>
1800 4014	A-26	26 mm	180 mm	100 mm	16-8	13-8	8.000 kg	2,3 kg	1	<b>51,77</b>



ANILLA TRIPLE PARA CADENA 3 Y 4 RAMALES / ANNEAU TRIPLE POUR CHAÎNE 3 ET 4 BRINS / RING FOR CHAINS 3&4 STRANDS  
ANELLO TRIPLO PER CATENA DA 3 E 4 BRACCIA / ELO TRIPLO PARA CORRENTE 3 E 4 RAMAIS

CE  
G 80



Medidas / Dimensions

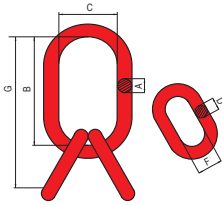

ES Para pulpos de cadena de 3 y 4 ramales EN 818-4.  
FR Pour des supports de chaîne de 3 et 4 branches EN 818-4.  
EN For chain straps kits of 3 or 4 straps EN 818-4.  
IT Per tiranti a catena da 3 e 4 braccia EN 818-4.  
PT Para kits de lingas de corrente de 3 e 4 ramais EN 818-4.

Ref	∅	A	B	C	D	E	F	G	max	kg		
1800 4020	6/7-8 mm	18 mm	135 mm	75 mm	13 mm	54 mm	25 mm	189 mm	2.360 kg	1,2 kg	1	44,39
1800 4021	8-8 mm	22 mm	160 mm	90 mm	16 mm	70 mm	34 mm	230 mm	4.250 kg	2,3 kg	1	65,00
1800 4022	10-8 mm	26 mm	180 mm	100 mm	18 mm	85 mm	40 mm	265 mm	6.700 kg	3,4 kg	1	85,80

CADENA ELEVACIÓN G-80 / CHAÎNE DE LEVAGE G-80 / LIFTING CHAIN G-80 / CATENA G-80 / CORRENTE DE ELEVAÇÃO

G 80

DIN EN 818-2  
ISO 3076

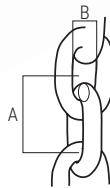

Ref	∅	A	B	max	kg		x m
1800 4030	6 mm	18 mm	8 mm	1.120 kg	0,8 m/kg	1	16,08
1800 4031	7 mm	21 mm	10,5 mm	1.500 kg	1,1 m/kg	1	18,04
1800 4032	8 mm	24 mm	10,8 mm	2.000 kg	1,5 m/kg	1	29,97
1800 4033	10 mm	30 mm	13,5 mm	3.150 kg	2,3 m/kg	1	38,58
1800 4034	13 mm	39 mm	17,5 mm	5.300 kg	3,8 m/kg	1	63,69

ANILLA TTE. SOLDABLE / CROCHET AVEC SECURITE / ELEVATION WELDED RING / ANELLO DI SOSPENSIONE / ANEL DE ELEVAÇÃO SOLDÁVEL

CE  
G 80



ES Fabricada según directiva de maquinaria 2006/42/CE. Anilla de Tiro forjada, normativa EN1677-4. Factor de Seguridad 4:1  
FR Fabriqué selon la directive 2006/42/CE. Anneau forgé, réglementation EN1677-4. Facteur de Sécurité 4:1  
EN Made according to the directive on machinery 2006/42/EC. Forged ring, EN 1677-4. Security factor 4:1  
IT Prodotto secondo la direttiva 2006/42/CE. Anello forgiato con la direttiva EN 1677-4. Fattore di Sicurezza 4:1  
PT Feito de acordo com a directiva 2006/42/CE, relativa às máquinas Anel forjado, EN 1677-4. Fator de segurança 4:1

Medidas  
Dimensions

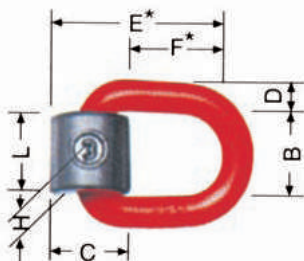

Ref	∅	A	B	C	D	E	F	G	max	kg		
1800 3610	6 mm	59 mm	31 mm	32 mm	32 mm	28 mm	12 mm	36 mm	1.120 kg	0,3 kg	1	36,87
1800 3611	8 mm	69 mm	37 mm	38 mm	38 mm	33 mm	14 mm	42 mm	2.000 kg	0,5 kg	1	39,41
1800 3612	10 mm	84 mm	46 mm	45 mm	44 mm	38 mm	18 mm	48 mm	3.450 kg	0,7 kg	1	59,94
1800 3613	13 mm	120 mm	69 mm	60 mm	60 mm	51 mm	24 mm	66 mm	5.300 kg	1,6 kg	1	119,90
1800 3614	16 mm	127 mm	66 mm	68 mm	65 mm	61 mm	28 mm	72 mm	8.000 kg	2,4 kg	1	163,14
1800 3615	22 mm	178 mm	98 mm	96 mm	109 mm	80 mm	39 mm	120 mm	15.000 kg	8,1 kg	1	361,91





GANCHO SOLDABLE / CROCHET AVEC SECURITE / WELD ON HOOK / GANCIO APPLICABILE SALDABILE / GANCHO SOLDÁVEL

CE

G 80



Medidas / Dimensions

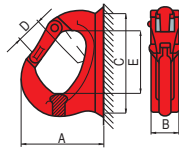

Ref	A	B	C	D	E	max			
<b>1800 3620</b>	92 mm	20 mm	114 mm	26,5 mm	67 mm	2.000 kg	0,83 kg	1	<b>46,61</b>
<b>1800 3621</b>	106 mm	24 mm	129 mm	30,5 mm	73,5 mm	3.000 kg	1,18 kg	1	<b>55,69</b>
<b>1800 3622</b>	136 mm	30 mm	171 mm	34,5 mm	94 mm	5.000 kg	2,5 kg	1	<b>89,76</b>
<b>1800 3623</b>	140 mm	39 mm	177 mm	34,5 mm	94 mm	8.000 kg	3,26 kg	1	<b>139,17</b>
<b>1800 3624</b>	172 mm	38 mm	223 mm	51 mm	134,5 mm	10.000 kg	51,7 kg	1	<b>179,18</b>

ACORTADOR ACCESO DIRECTO A CADENA / CROCHET / HOOK OF DIRECT ACCESS TO THE CHAIN  
GANCIO / GANCHO ENCURTADOR ACCESO DIRETO PARA A CORRENTE

CE

G 80



Medidas / Dimensions

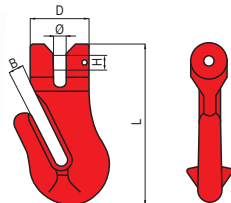

Ref	Ø	B	D	H	L	max			
<b>1800 4001</b>	6 mm	6,5 mm	8 mm	19 mm	85 mm	1.120 kg	0,2 kg	1	<b>12,79</b>
<b>1800 4002</b>	8 mm	9 mm	10 mm	26 mm	111 mm	2.000 kg	0,5 kg	1	<b>14,63</b>
<b>1800 4003</b>	10 mm	12 mm	12 mm	29 mm	131 mm	3.150 kg	3,4 kg	1	<b>43,86</b>

CÁNCAMO GIRATORIO / CROCHET ROTATIF / ROTATORY EYE BOLT / ANELLO GIREVOLE / OLHAL ROTATIVO DE ELEVAÇÃO

CE

G 80

ES Fabricado según directiva de maquinaria 2006/42/CE. Anilla de Tiro forjada, normativa EN1677-4. Factor de Seguridad 4:1.  
FR Fabriqué selon la directive 2006/42/CE. Anneau forgé, réglementation EN1677-4. Facteur de Sécurité 4:1.  
EN Made according to the directive on machinery 2006/42/EC. Forged ring, EN 1677-4. Security factor 4:1.  
IT Prodotto secondo la direttiva 2006/42/CE. Anello forgiato con la direttiva EN 1677-4. Fattore di Sicurezza 4:1.  
PT Feito de acordo com a directiva 2006/42/CE, relativa às máquinas Anel forjado, EN 1677-4. Fator de segurança 4:1.



Ref	D x L	A	B	C	E	H	SW	max			
<b>1800 3630</b>	10 x 18 mm	59 mm	31 mm	32 mm	32 mm	28 mm	12 mm	300 kg	0,430 kg	1	<b>142,93</b>
<b>1800 3631</b>	12 x 18 mm	69 mm	37 mm	38 mm	38 mm	33 mm	14 mm	500 kg	0,500 kg	1	<b>149,39</b>
<b>1800 3632</b>	16 x 20 mm	84 mm	46 mm	45 mm	44 mm	38 mm	18 mm	1.000 kg	0,530 kg	1	<b>156,11</b>
<b>1800 3633</b>	20 x 30 mm	120 mm	69 mm	60 mm	60 mm	51 mm	24 mm	2.000 kg	1,050 kg	1	<b>218,23</b>
<b>1800 3634</b>	24 x 30 mm	127 mm	66 mm	68 mm	65 mm	61 mm	28 mm	3.000 kg	1,630 kg	1	<b>326,55</b>
<b>1800 3635</b>	30 x 35 mm	178 mm	98 mm	96 mm	109 mm	80 mm	39 mm	5.000 kg	2,230 kg	1	<b>792,32</b>

Medidas  
Dimensions

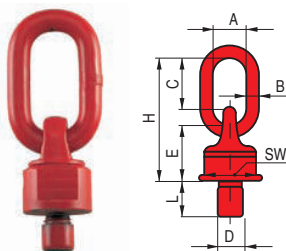

Ref	MODEL								
<b>1800 3630</b>	300 kg	600 kg	1.180 kg	300 kg	600 kg	420 kg	300 kg	630 kg	450 kg
<b>1800 3631</b>	500 kg	1.000 kg	2.000 kg	500 kg	1.000 kg	750 kg	500 kg	1.100 kg	750 kg
<b>1800 3632</b>	1.000 kg	2.000 kg	4.000 kg	1.120 kg	2.000 kg	1.500 kg	1.120 kg	2.360 kg	1.600 kg
<b>1800 3633</b>	2.000 kg	4.000 kg	8.000 kg	2.000 kg	4.000 kg	2.800 kg	2.000 kg	4.000 kg	W.000 kg
<b>1800 3634</b>	3.000 kg	6.300 kg	12.500 kg	3.150 kg	6.300 kg	4.250 kg	3.150 kg	6.300 kg	4.750 kg
<b>1800 3635</b>	5.000 kg	10.600 kg	21.200 kg	5.300 kg	10.600 kg	7.100 kg	5.300 kg	11.200 kg	8.000 kg



HAMMERLOCK PARA CADENA / HAMMERLOCK POUR CHAÎNE / HAMMERLOCK FOR CHAIN  
HAMMERLOCK PER CATENA / HAMMERLOCK (ELO DE LIGAÇÃO) PARA CORRENTE

CE  
G 80



Ref	Ø	▲ max	📦	📊
1800 2401	6 mm	1.000 kg	1	12,93
1800 2402	7 mm	2.000 kg	1	14,77
1800 2403	8 mm	2.000 kg	1	17,88
1800 2404	10 mm	3.200 kg	1	19,14
1800 2405	13 mm	5.000 kg	1	29,43
1800 2406	16 mm	8.000 kg	1	47,32
1800 2407	18/20 mm	12.500 kg	1	68,82

Medidas  
Dimensions

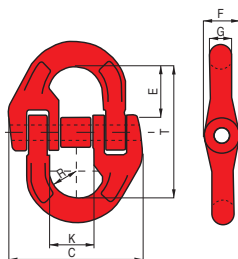

Ø	C	E	F	G	K	R	T	▲
6 mm	42 mm	18 mm	13 mm	7 mm	14 mm	8,0 mm	48 mm	0,1 kg
7 mm	54 mm	22 mm	14 mm	9 mm	20 mm	11,0 mm	56 mm	0,2 kg
8 mm	54 mm	22 mm	14 mm	9 mm	20 mm	11,0 mm	56 mm	0,2 kg
10 mm	68 mm	28 mm	18 mm	12 mm	26 mm	12,5 mm	68 mm	0,3 kg
13 mm	79 mm	32 mm	23 mm	16 mm	27 mm	16,0 mm	85 mm	0,6 kg
16 mm	97 mm	40 mm	26 mm	19 mm	33 mm	20,0 mm	104 mm	1,1 kg
18/20 mm	118 mm	46 mm	33 mm	22 mm	41 mm	23,0 mm	122 mm	2,0 kg

GANCHO CON SEGURO ALTA RESISTENCIA ACERO ALEADO / CROCHET - SÉCURITÉ ANTI RETOUR - ALLIAGE ACIR / HIGH RESISTANCE ALLOY STEEL HOOK  
GANCIO CON SICUREZZA AD ALTA RESISTENZA IN ACCIAIO / GANCHO OLHAL COM TRAVA DE SEGURANÇA LIGA DE AÇO

CE



Ref	▲ max	📦	📊
1800 3601	1.000 kg	1	11,34
1800 3602	1.500 kg	1	15,18
1800 3603	2.000 kg	1	18,65
1800 3604	3.000 kg	1	25,16
1800 3605	4.500 kg	1	47,93
1800 3606	7.000 kg	1	115,58

Medidas  
Dimensions

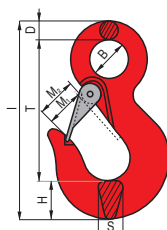

▲ max	B	D	H	L	M1	M2	S	T
1.000 Kg	20 mm	11 mm	20 mm	117 mm	21 mm	26 mm	16 mm	86 mm
1.500 Kg	24 mm	12 mm	25 mm	134 mm	24 mm	28 mm	18 mm	98 mm
2.000 Kg	26 mm	13 mm	31 mm	157 mm	25 mm	32 mm	21 mm	113 mm
3.000 Kg	30 mm	15 mm	33 mm	168 mm	26 mm	34 mm	25 mm	121 mm
4.500 Kg	40 mm	20 mm	41 mm	207 mm	31 mm	40 mm	33 mm	146 mm
7.000 Kg	54 mm	25 mm	49 mm	262 mm	38 mm	52 mm	42 mm	186 mm

GANCHO GIRATORIO CON SEGURO ACERO AL CARBONO C40 / CROCHET TOURNANT SÉCURITÉ ANTI RETOUR ACIER AU CARBONE C40  
ROTATORY HOOK WITH STEEL SAFETY CATCH C40 / GANCIO CON SICUREZZA GIREVOLE IN CARBONIO C40  
GANCHO GIRATÓRIO COM TRAVA DE SEGURANÇA AÇO CARBONO C40

CE



Ref	▲ max	📦	📊
1800 3701	750 kg	1	13,56
1800 3702	1.000 kg	1	12,93
1800 3703	1.500 kg	1	18,66
1800 3704	2.000 kg	1	23,71
1800 3705	3.000 kg	1	46,04
1800 3706	5.000 kg	1	83,64
1800 3707	7.500 kg	1	132,79

Medidas  
Dimensions

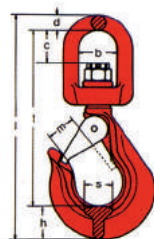

▲ max	B	C	D	H	L	M	S	T
750 Kg	29 mm	24 mm	10 mm	18 mm	140 mm	18 mm	18 mm	110 mm
1.000 Kg	28 mm	21 mm	10 mm	27 mm	166 mm	19 mm	21 mm	128 mm
1.500 Kg	35 mm	30 mm	14 mm	29 mm	217 mm	28 mm	25 mm	171 mm
2.000 Kg	36 mm	32 mm	17 mm	32 mm	229 mm	28 mm	30 mm	180 mm
3.000 Kg	38 mm	30 mm	18 mm	42 mm	261 mm	33 mm	31 mm	201 mm
5.000 Kg	61 mm	58 mm	28 mm	48 mm	357 mm	44 mm	42 mm	288 mm
7.500 Kg	70 mm	63 mm	30 mm	60 mm	370 mm	48 mm	47 mm	281 mm



GANCHO GIRATORIO DE ALTA SEGURIDAD G-80 / CROCHET TOURNANT G-80 / ROTATORY HIGH SECURITY HOOK G-80  
GANCIO GIREVOLE AD ALTA SICUREZZA G-80 / GANCHO GIRATÓRIO DE ALTA SEGURANÇA G-80

CE

G 80



Ref	$\Delta_{max}$		
1800 3901	1.200 kg	1	38,64
1800 3902	2.000 kg	1	52,62
1800 3903	3.200 kg	1	93,50
1800 3904	5.400 kg	1	209,40
1800 3905	8.200 kg	1	397,50

Medidas  
Dimensions

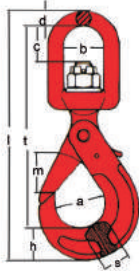

$\Delta_{max}$	A	B	C	D	H	L	M	S	T
1200 Kg	35 mm	30 mm	29 mm	12 mm	25 mm	187 mm	30 mm	18 mm	150 mm
2000 Kg	45 mm	33 mm	25 mm	12,5 mm	28 mm	225 mm	37 mm	22 mm	175 mm
3200 Kg	55 mm	40 mm	33 mm	15 mm	36 mm	260 mm	44 mm	28 mm	212 mm
5400 Kg	70 mm	50 mm	40 mm	17 mm	46 mm	320 mm	57 mm	36 mm	254 mm
8200 Kg	90 mm	60 mm	54 mm	20 mm	51 mm	400 mm	74 mm	37 mm	321 mm

GANCHO DE ALTA SEGURIDAD G-80 / CROCHET DE LEVAGE HAUTE SÉCURITÉ G-80 / HIGH SECURITY HOOK G-80  
GANCIO AD ALTA SICUREZZA G-80 / GANCHO DE ALTA SEGURANÇA G-80

CE

G 80



Ref	$\Delta_{max}$		
1800 3801	1.200 kg	1	33,80
1800 3802	2.000 kg	1	38,69
1800 3803	3.200 kg	1	65,00
1800 3804	5.400 kg	1	119,39
1800 3805	8.200 kg	1	245,96

Medidas  
Dimensions

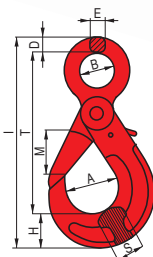

$\Delta_{max}$	A	B	D	E	H	L	M	S	T
1.200 Kg	35 mm	23 mm	10 mm	10 mm	23 mm	142 mm	30 mm	18 mm	108 mm
2.000 Kg	45 mm	30 mm	14 mm	10 mm	28 mm	176 mm	37 mm	22 mm	133 mm
3.200 Kg	55 mm	36 mm	15 mm	12 mm	36 mm	216 mm	44 mm	28 mm	165 mm
5.400 Kg	70 mm	45 mm	20 mm	16 mm	47 mm	264 mm	55 mm	36 mm	199 mm
8.200 Kg	90 mm	58 mm	22 mm	20 mm	55 mm	328 mm	73 mm	37 mm	250 mm

GANCHO ALTA SEGURIDAD G-80 - CONEXIÓN DIRECTA / CROCHET DE LEVAGE HAUTE SÉCURITÉ G-80 - MAILLAGE DIRECT  
HIGH SECURITY HOOK G-80 - DIRECT CONNECTION / GANCIO AD ALTA SICUREZZA G-80 - CONNESSIONE DIRETTA  
GANCHO DE ALTA SEGURANÇA G-80 LIGAÇÃO DIRETA

CE

G 80



Ref	$\Delta_{max}$		
1800 4201	1.200 kg	1	38,64
1800 4202	2.000 kg	1	44,86
1800 4203	3.200 kg	1	75,05
1800 4204	5.400 kg	1	136,45
1800 4205	8.200 kg	1	239,72

Medidas  
Dimensions

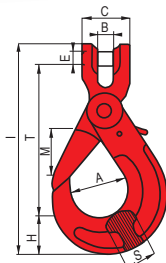

$\Delta_{max}$	A	B	C	D	H	L	M	S	T
1.200 Kg	35 mm	6,5 mm	29 mm	8,2 mm	25 mm	125 mm	30 mm	18 mm	86 mm
2.000 Kg	45 mm	8,5 mm	32 mm	9,2 mm	28 mm	155 mm	37 mm	22 mm	110 mm
3.200 Kg	55 mm	10,5 mm	42 mm	13,2 mm	36 mm	200 mm	44 mm	28 mm	140 mm
5.400 Kg	70 mm	14 mm	53 mm	16,2 mm	47 mm	248 mm	55 mm	36 mm	174 mm
8.200 Kg	90 mm	17,5 mm	68 mm	20,2 mm	52 mm	292 mm	74 mm	37 mm	210 mm



GANCHO DIN 689 CON SEGURO / CROCHET DIN 689 - SÉCURITÉ ANTI RETOUR / HOOK DIN 689 WITH CLASP  
 GANCIO DIN 689 CON SICUREZZA / GANCHO COM SEGURANÇA DIN 689



Ref	▲ max	📦	📦
<b>1800 3401</b>	250 kg	1	<b>2,57</b>
<b>1800 3402</b>	500 kg	1	<b>4,60</b>
<b>1800 3403</b>	1.000 kg	1	<b>11,30</b>
<b>1800 3404</b>	1.600 kg	1	<b>18,06</b>
<b>1800 3405</b>	2.500 kg	1	<b>36,78</b>

**Medidas**  
**Dimensions**

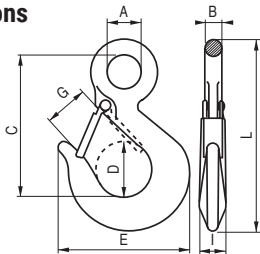

▲ max	A	B	C	D	E	G	H	I	L
250 kg	12 mm	7,5 mm	19,5 mm	23 mm	53,5 mm	15 mm	64 mm	13,0 mm	88,5 mm
500 kg	16 mm	10,0 mm	26,0 mm	31 mm	71,5 mm	22 mm	85 mm	17,0 mm	117,5 mm
1.000 kg	20 mm	13,5 mm	36,0 mm	42 mm	98,0 mm	25 mm	116 mm	23,5 mm	160,5 mm
1.600 kg	26 mm	16,0 mm	39,5 mm	50 mm	116,0 mm	31 mm	138 mm	28,0 mm	190,5 mm
2.500 kg	32 mm	20,0 mm	40,5 mm	60 mm	125,0 mm	39 mm	170 mm	28,0 mm	200 mm

MALLA RÁPIDA / MAILLE RAPIDE / SNAP / MAGLIA RAPIDA / MOSQUETÃO



Ref	∅	📦	📦
<b>1800 2701</b>	3.5 mm	100	<b>0,68</b>
<b>1800 2702</b>	4 mm	100	<b>0,77</b>
<b>1800 2703</b>	5 mm	100	<b>0,90</b>
<b>1800 2704</b>	6 mm	50	<b>1,11</b>
<b>1800 2705</b>	7 mm	50	<b>1,30</b>
<b>1800 2706</b>	8 mm	25	<b>1,55</b>
<b>1800 2707</b>	9 mm	25	<b>2,32</b>
<b>1800 2708</b>	10 mm	25	<b>2,76</b>
<b>1800 2709</b>	12 mm	10	<b>7,01</b>
<b>1800 2710</b>	14 mm	10	<b>7,98</b>
<b>1800 2711</b>	16 mm	10	<b>10,51</b>

**Medidas**  
**Dimensions**

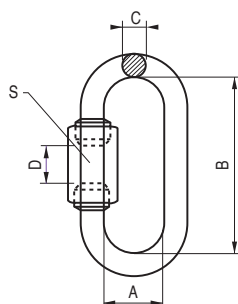

∅	Ref	A	B	C	D	S
3,5 mm	10 kg	10,0 mm	30,0 mm	3,5 mm	4,0 mm	7,0 mm
4 mm	10 kg	12,0 mm	33,0 mm	4,0 mm	5,0 mm	8,0 mm
5 mm	20 kg	13,0 mm	40,0 mm	5,0 mm	6,5 mm	9,0 mm
6 mm	30 kg	15,0 mm	46,0 mm	6,0 mm	9,0 mm	11,0 mm
7 mm	60 kg	16,0 mm	52,0 mm	7,0 mm	9,0 mm	12,5 mm
8 mm	80 kg	17,5 mm	58,0 mm	8,0 mm	9,5 mm	14,0 mm
9 mm	110 kg	19,0 mm	62,0 mm	9,0 mm	10,0 mm	15,0 mm
10 mm	150 kg	20,5 mm	69,0 mm	10,0 mm	13,0 mm	17,0 mm
12 mm	230 kg	23,5 mm	80,5 mm	12,0 mm	14,5 mm	19,0 mm
14 mm	350 kg	27,0 mm	97,0 mm	14,0 mm	16,0 mm	22,0 mm
16 mm	450 kg	29,5 mm	113,0 mm	16,0 mm	21,0 mm	24,0 mm



ABARCÓN CINCADO / ARC ZINGUÉ / ZINC COATED ARC / CAVALLOTTI ZINCATI / GRAMPO TIPO "U" ZINCADO



Ref	🌀	∅	∅	📦	📊
<b>1800 4501</b>	M-6	18 mm	3/8"	50	<b>0,35</b>
<b>1800 4502</b>	M-6	20 mm	1/2"	50	<b>0,36</b>
<b>1800 4503</b>	M-8	28 mm	3/4"	25	<b>0,37</b>
<b>1800 4504</b>	M-8	35 mm	1"	25	<b>0,38</b>
<b>1800 4505</b>	M-8	42 mm	1"1/4	25	<b>0,45</b>
<b>1800 4506</b>	M-8	48 mm	1"1/2	25	<b>0,95</b>
<b>1800 4507</b>	M-8	60 mm	2"	25	<b>1,15</b>
<b>1800 4508</b>	M-8	75 mm	2"1/2	10	<b>1,35</b>
<b>1800 4509</b>	M-10	90 mm	3"	10	<b>1,63</b>
<b>1800 4510</b>	M-10	100 mm	3"1/2	10	<b>1,96</b>
<b>1800 4511</b>	M-10	115 mm	4"	5	<b>2,09</b>
<b>1800 4512</b>	M-10	140 mm	5"	1	<b>2,25</b>
<b>1800 4513</b>	M-10	160 mm	6"	1	<b>2,65</b>
<b>1800 4514</b>	M-10	220 mm	8"	1	<b>3,29</b>
<b>1800 4515</b>	M-10	273 mm	10"	1	<b>4,24</b>
<b>1800 4516</b>	M-10	325 mm	12"	1	<b>4,87</b>

GANCHO ESPECIAL PARA REDES 8mm / CROCHET SPÉCIAL 8mm / SPECIAL HOOK 8mm  
 GANCIO SPECIALE, 8mm / GANCHO ESPECIAL PARA REDES 8mm



Ref	∅	📦	📊
<b>1800 4801</b>	8 mm	35	<b>1,33</b>

GANCHO EN "S" ZINCADO / CROCHETS ZINGUÉS EN "S" / "S" ZINC HOOK / GANCIO A "S" ZINCATO / GANCHO EM "S" ZINCADO



Ref	∅	📦	📊
<b>1800 2101</b>	3 mm	200	<b>0,12</b>
<b>1800 2103</b>	4 mm	200	<b>0,14</b>
<b>1800 2105</b>	5 mm	100	<b>0,21</b>
<b>1800 2107</b>	6 mm	100	<b>0,31</b>
<b>1800 2108</b>	7 mm	50	<b>0,58</b>
<b>1800 2109</b>	8 mm	50	<b>0,80</b>

Medidas  
Dimensions

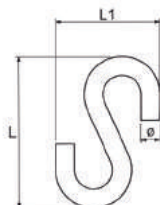

M	L	L1	∅	📊 max
3	30,0 mm	16,0 mm	3 mm	3 kg
4	38,5 mm	21,5 mm	4 mm	8 kg
5	46,0 mm	26,5 mm	5 mm	13 kg
6	52,5 mm	31,5 mm	6 mm	22 kg
7	61,0 mm	36,0 mm	7 mm	37 kg
8	64,0 mm	44,0 mm	8 mm	50 kg



CADENA DE ACERO ZINCADO SOLDADA, EN BOBINA / CHAINE ACIER ZN SOUDE, EN BOBINE / WELDED ZINC STEEL CHAIN  
 CATENA IN ACCIAIO ZINCATO / CORRENTE EM AÇO ZINCADO SOLDADA, EM ROLO



Medidas  
 Dimensions

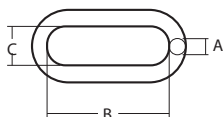

Precio por bobina.  
 Prix par bobine.  
 Price per coil.  
 Prezzo per bobina.  
 Preço por bobina.

Ref	↔	A	B	C	△ <sub>max</sub>	Kg/m	📦
1060 0020	200 m	2,0 mm	15,0 mm	6,0 mm	-	0,069	140,59
1060 0025	180 m	2,5 mm	15,0 mm	6,5 mm	-	0,111	225,42
1060 0030	160 m	3,0 mm	18,5 mm	5,0 mm	-	0,155	228,72
1060 0040	80 m	4,0 mm	21,0 mm	7,0 mm	150 kg	0,285	161,10
1060 0050	50 m	5,0 mm	26,0 mm	9,0 mm	220 kg	0,456	142,00
1060 0060	32 m	6,0 mm	27,5 mm	11,0 mm	275 kg	0,675	142,83
1060 0070	24 m	7,0 mm	31,0 mm	12,0 mm	450 kg	0,925	134,97
1060 0080	20 m	8,0 mm	36,0 mm	15,0 mm	500 kg	1,250	143,10
1060 0100	12 m	10,0 mm	42,0 mm	16,0 mm	1000 kg	1,950	138,89
1060 0120	8 m	12,0 mm	43,0 mm	16,0 mm	1350 kg	2,800	140,59

Bobinas adaptables a cualquier expositor / Bobines adaptables à tout type de présentoir / Versatile reels for all displays.  
 Bobina adattabile a qualunque espositore / Rolos versáteis para qualquer expositor.

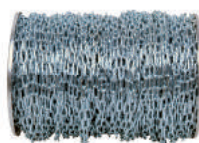

Ref	📦	📦
EXPOSITOR 8	ONLY DISPLAY EXPOSITOR VACÍO	289,50

CABLE / CÂBLE / CABLE / CAVI / CABO

CABLE ACERO INOX D-1570 7X7+0 AISI 316 (A-4) / CÂBLE INOX D-1570 7X7+0 AISI 316 (A-4) / CABLE STAINLESS STEEL D-1570 7X7+0 AISI 316 (A-4)  
 CAVI INOX D-1570 7X7+0 AISI 316 (A-4) / CABO EM AÇO INOX D-1570 7X7+0 AISI 316 (A-4)

INOX A-4 / AISI 316

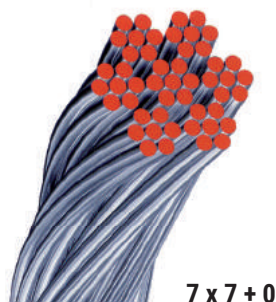

Ref	↔	∅ <sub>ext</sub>	∅ <sub>int</sub>	📦	📦
0050 9999	50 m	2 mm	0,20 mm	230 kg	0,014 kg/m
0050 9999A	100 m	2 mm	0,20 mm	230 kg	0,014 kg/m
0050 9999B	250 m	2 mm	0,20 mm	230 kg	0,014 kg/m
0050 0000	50 m	3 mm	0,30 mm	500 kg	0,031 kg/m
0050 0000A	100 m	3 mm	0,30 mm	500 kg	0,031 kg/m
0050 0000B	250 m	3 mm	0,30 mm	500 kg	0,031 kg/m
0050 1000	50 m	4 mm	0,40 mm	1.000 kg	0,061 kg/m
0050 1000A	100 m	4 mm	0,40 mm	1.000 kg	0,061 kg/m
0050 1000B	250 m	4 mm	0,40 mm	1.000 kg	0,061 kg/m
0050 1001	50 m	5 mm	0,50 mm	1.600 kg	0,094 kg/m
0050 1001A	100 m	5 mm	0,50 mm	1.600 kg	0,094 kg/m
0050 1001B	250 m	5 mm	0,50 mm	1.600 kg	0,094 kg/m
0050 1002	50 m	6 mm	0,60 mm	2.200 kg	0,133 kg/m
0050 1002A	100 m	6 mm	0,60 mm	2.200 kg	0,133 kg/m
0050 1002B	250 m	6 mm	0,60 mm	2.200 kg	0,133 kg/m
0050 1003	50 m	8 mm	0,80 mm	3.670 kg	0,246 kg/m
0050 1003A	100 m	8 mm	0,80 mm	3.670 kg	0,246 kg/m
0050 1003B	250 m	8 mm	0,80 mm	3.670 kg	0,246 kg/m
0050 1004	50 m	10 mm	1,10 mm	6.300 kg	0,375 kg/m
0050 1004A	100 m	10 mm	1,10 mm	6.300 kg	0,375 kg/m
0050 1004B	250 m	10 mm	1,10 mm	6.300 kg	0,375 kg/m

CONSULTEN DISPONIBILIDAD Y PRECIO PARA TALLAS ESPECIALES  
 CONSULTEZ NOS DISPONIBILITES ET NOS PRIX POUR LES TAILLES SPECIALES  
 PLEASE CHECK AVAILABILITY AND PRICE FOR SPECIAL SIZES  
 CONSULTARE DISPONIBILITÀ E PREZZO PER TAGLIE SPECIALI  
 CONSULTE A DISPONIBILIDADE E O PREÇO PARA TAMANHOS ESPECIAIS

CABLE GALVANIZADO D-1770 6X7+1 / CÂBLE GALVANISE D-1770 6X7+1 / GALVANIZED WIRE D-1770 6X7+1  
CAVO GALVANIZZATO D-1770 6X7+1 / CABO GALVANIZADO D-1770 6X7+1**6 x 7 + 1**Precio por rollo.  
Prix par rouleau.  
Price per roll.  
Prezzo per rotolo.  
Preço por rolo.

Ref	↔	∅	∅ <sub>int</sub>	📦	🏗️	📊
<b>0050 2001</b>	50 m	2 mm	0,21 mm	239 kg	0,014 kg/m	<b>14,74</b>
<b>0050 2001A</b>	100 m	2 mm	0,21 mm	239 kg	0,014 kg/m	<b>26,21</b>
<b>0050 2001B</b>	250 m	2 mm	0,21 mm	239 kg	0,014 kg/m	<b>65,52</b>
<b>0050 2002</b>	50 m	3 mm	0,32 mm	538 kg	0,030 kg/m	<b>20,69</b>
<b>0050 2002A</b>	100 m	3 mm	0,32 mm	538 kg	0,030 kg/m	<b>39,31</b>
<b>0050 2002B</b>	250 m	3 mm	0,32 mm	538 kg	0,030 kg/m	<b>98,28</b>
<b>0050 2003</b>	50 m	4 mm	0,42 mm	957 kg	0,052 kg/m	<b>30,58</b>
<b>0050 2003A</b>	100 m	4 mm	0,42 mm	957 kg	0,052 kg/m	<b>61,15</b>
<b>0050 2003B</b>	250 m	4 mm	0,42 mm	957 kg	0,052 kg/m	<b>152,88</b>
<b>0050 2004</b>	50 m	5 mm	0,53 mm	1.500 kg	0,083 kg/m	<b>43,68</b>
<b>0050 2004A</b>	100 m	5 mm	0,53 mm	1.500 kg	0,083 kg/m	<b>87,36</b>
<b>0050 2004B</b>	250 m	5 mm	0,53 mm	1.500 kg	0,083 kg/m	<b>218,40</b>
<b>0050 2005</b>	50 m	6 mm	0,63 mm	2.150 kg	0,118 kg/m	<b>69,89</b>
<b>0050 2005A</b>	100 m	6 mm	0,63 mm	2.150 kg	0,118 kg/m	<b>139,57</b>
<b>0050 2005B</b>	250 m	6 mm	0,63 mm	2.150 kg	0,118 kg/m	<b>349,44</b>

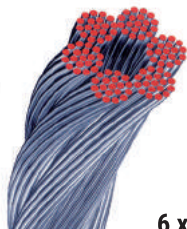
CABLE GALVANIZADO D-1770 6X19+1 / CÂBLE GALVANISE D-1770 6X19+1 / GALVANIZED WIRE D-1770 6X19+1  
CAVO GALVANIZZATO D-1770 6X19+1 / CABO GALVANIZADO D-1770 6X19+1**6 x 19 + 1**Precio por rollo.  
Prix par rouleau.  
Price per roll.  
Prezzo per rotolo.  
Preço por rolo.

Ref	↔	∅	∅ <sub>int</sub>	📦	🏗️	📊
<b>0050 2006</b>	50 m	8 mm	0,51 mm	3.540 kg	0,22 kg/m	<b>115,75</b>
<b>0050 2006A</b>	100 m	8 mm	0,51 mm	3.540 kg	0,22 kg/m	<b>231,50</b>
<b>0050 2006B</b>	250 m	8 mm	0,51 mm	3.540 kg	0,22 kg/m	<b>578,76</b>
<b>0050 2007</b>	25 m	10 mm	0,63 mm	5.530 kg	0,35 kg/m	<b>81,90</b>
<b>0050 2007A</b>	50 m	10 mm	0,63 mm	5.530 kg	0,35 kg/m	<b>163,80</b>
<b>0050 2007B</b>	100 m	10 mm	0,63 mm	5.530 kg	0,35 kg/m	<b>327,60</b>
<b>0050 2008</b>	25 m	12 mm	0,63 mm	7.970 kg	0,47 kg/m	<b>99,37</b>
<b>0050 2008A</b>	50 m	12 mm	0,63 mm	7.970 kg	0,47 kg/m	<b>198,74</b>

CABLE DE ACERO FORRADO PLÁSTICO CRISTAL / CÂBLE ACIER GAINÉ TRANSPARENTE PLASTIQUE / STEEL CABLE WITH TRANSPARENT PLASTIC COVER  
CAVO IN ACCIAIO CON RIVESTIMENTO IN PVC CRISTAL / CABO DE AÇO FORRADO DE PLÁSTICO DE VIDRO**6 x 7 + 1****6 x 19 + 1****Cable forrado**Precio por rollo.  
Prix par rouleau.  
Price per roll.  
Prezzo per rotolo.  
Preço por rolo.

Ref	↔	∅	MODEL	📦	🏗️	📊
<b>0050 3004</b>	50 m	2x4 mm	6x7+1	239 kg	0,014 kg/m	<b>41,50</b>
<b>0050 3004A</b>	100 m	2x4 mm	6x7+1	239 kg	0,014 kg/m	<b>82,99</b>
<b>0050 3005</b>	50 m	3x5 mm	6x7+1	500 kg	0,032 kg/m	<b>56,78</b>
<b>0050 3005A</b>	100 m	3x5 mm	6x7+1	500 kg	0,032 kg/m	<b>113,57</b>
<b>0050 3006</b>	50 m	4x6 mm	6x7+1	1.000 kg	0,061 kg/m	<b>72,07</b>
<b>0050 3006A</b>	100 m	4x6 mm	6x7+1	1.000 kg	0,061 kg/m	<b>144,14</b>
<b>0050 3007</b>	50 m	5x7 mm	6x7+1	1.600 kg	0,094 kg/m	<b>96,10</b>
<b>0050 3007A</b>	100 m	5x7 mm	6x7+1	1.600 kg	0,094 kg/m	<b>192,19</b>
<b>0050 3008</b>	50 m	6x8 mm	6x7+1	2.200 kg	0,133 kg/m	<b>124,49</b>
<b>0050 3008A</b>	100 m	6x8 mm	6x7+1	2.200 kg	0,133 kg/m	<b>248,98</b>
<b>0050 3010</b>	25 m	8x10 mm	6x19+1	3.670 kg	0,246 kg/m	<b>107,02</b>
<b>0050 3010A</b>	50 m	8x10 mm	6x19+1	3.670 kg	0,246 kg/m	<b>214,03</b>
<b>0050 3012</b>	25 m	10x12 mm	6x19+1	6.300 kg	0,375 kg/m	<b>150,70</b>
<b>0050 3012A</b>	50 m	10x12 mm	6x19+1	6.300 kg	0,375 kg/m	<b>336,86</b>



BLÍSTER - CINTA PERSIANA (GRIS/BEIGE) / BLISTER - RUBAN STORE (GRIS/BEIGE) / BLISTER - TAPE BLIND (GREY/BEIGE)  
 BLISTER - NASTRO TAPPARELLA (GRIGIO/BEIGE) / BLISTER - FITA PERSIANA (CINZENTO/BEGE)



**DOBLE CARA**

Ref	↔	↕	📦	📦	📦	📦
<b>0810 1094</b>	6 m	22 mm	1	10	<b>4,70</b>	✓
<b>0810 1095</b>	5 m	22 mm	1	10	<b>3,91</b>	✓

BLÍSTER - CINTA PERSIANA MINI (GRIS) / BLISTER - RUBAN STORE (GRIS) / BLISTER - TAPE BLIND (GREY)  
 BLISTER - NASTRO TAPPARELLA (GRIGIO) / BLISTER - FITA DE PERSIANA (CINZA)

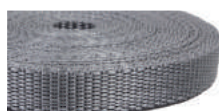

**MINI**

Ref	↔	↕	📦	📦	📦
<b>0810 1096</b>	6 m	14 mm	1	<b>3,37</b>	✓
<b>0810 1097</b>	5 m	14 mm	1	<b>2,85</b>	✓

ROLLO CINTA PERSIANA (GRIS/BEIGE) / RUBAN STORE (GRIS/BEIGE) / TAPE BLIND (GREY/BEIGE)  
 NASTRO TAPPARELLA (GRIGIO/BEIGE) / ROLO DE FITA DE PERSIANA (CINZA/BEGE)



**DOBLE CARA**

GRIS-BEIGE / GRIS-BEIGE / GREY-BEIGE  
 GRIGIO-BEIGE / CINZA-BEGE

Ref	↔	↕	📦	📦
<b>0810 1091</b>	50 m	22 mm	1	<b>22,26</b>

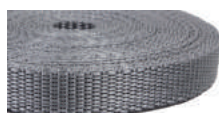

**GRIS**

GRIS / GRIS / GREY / GRIGIO / CINZA

Ref	↔	↕	📦	📦
<b>0810 1092</b>	50 m	17 mm	1	<b>17,91</b>
<b>0810 1093</b>	50 m	14 mm	1	<b>16,82</b>





ESLINGAS PLANAS CON GAZAS / ELINGUES PLATES AVEC BOUCLES / WEBBING SLING  
CINGHIA PIANA CON ASOLE / ESLINGA PLANA COM ABERTURAS



ES Su diseño compacto y la nueva técnica para el tratamiento de la eslinga la dotan de una resistencia a la ruptura. El tejido especial de los bordes y gazas reforzadas la dotan de una gran protección contra la abrasión y otros desperfectos. Todo ello garantiza una larga durabilidad.

FR Son design compact et la nouvelle technique du traitement de l'élingue la dote d'une haute résistance à la rupture. Le tissu spécial couvrant les bords et les boucles renforcées offrent une grande protection contre l'abrasion et les frottements, ce qui garantit une longue durabilité.

EN Very compact design and a new process technology give a good breaking elongation to these webbing slings. Specially woven edge and reinforced loops give them a protection from abrasion and damage. These special properties guarantee an extremely long service life.

IT Il suo disegno compatto e la nuova tecnica di trattamento della cinghia assicurano una elevata resistenza alla rottura. Le finiture speciali dei bordi e le asole rinforzate conferiscono alla cinghia una elevata protezione contro abrasioni e altri incidenti. Tutto ciò a garanzia di una lunga durata.

PT Design muito compacto e uma nova tecnologia de tratamento dão a estas cintas sintéticas resistência à ruptura. Especial tecido e bordas reforçadas dão protecção contra a abrasão e danos. Estas propriedades especiais garantem uma vida útil extremamente longa.

Ref						
0850 1001		1 m	30 mm	7,5 mm	1.000 kg	<b>3,97</b>
0850 1002		2 m	30 mm	7,5 mm	1.000 kg	<b>8,24</b>
0850 1004		4 m	30 mm	7,5 mm	1.000 kg	<b>13,71</b>
0850 1006		6 m	30 mm	7,5 mm	1.000 kg	<b>27,36</b>
0850 1010		10 m	30 mm	7,5 mm	1.000 kg	<b>39,77</b>
0850 2002		2 m	60 mm	7,5 mm	2.000 kg	<b>14,27</b>
0850 2003		3 m	60 mm	7,5 mm	2.000 kg	<b>21,18</b>
0850 2004		4 m	60 mm	7,5 mm	2.000 kg	<b>27,12</b>
0850 2006		6 m	60 mm	7,5 mm	2.000 kg	<b>40,21</b>
0850 2008		8 m	60 mm	7,5 mm	2.000 kg	<b>53,40</b>

Ref						
0850 3003		3 m	90 mm	7,5 mm	3.000 kg	<b>33,10</b>
0850 3004		4 m	90 mm	7,5 mm	3.000 kg	<b>42,55</b>
0850 3006		6 m	90 mm	7,5 mm	3.000 kg	<b>64,74</b>
0850 3008		8 m	90 mm	7,5 mm	3.000 kg	<b>73,75</b>
0850 3010		10 m	90 mm	7,5 mm	3.000 kg	<b>109,34</b>
0850 4004		4 m	120 mm	7,5 mm	4.000 kg	<b>54,21</b>
0850 4006		6 m	120 mm	7,5 mm	4.000 kg	<b>86,11</b>
0850 4010		10 m	120 mm	7,5 mm	4.000 kg	<b>145,88</b>
0850 6004		4 m	180 mm	7,5 mm	6.000 kg	<b>100,40</b>
0850 6006		6 m	180 mm	7,5 mm	6.000 kg	<b>133,68</b>
0850 6010		10 m	180 mm	7,5 mm	6.000 kg	<b>218,68</b>

ESLINGAS TUBULARES / ELINGUES TUBULAIRES / ROUND SLINGS / CINGHIA TUBOLARE / ESLINGA CIRCULAR



ES La solución ideal para el levantamiento seguro de todo tipo de cargas, tanto si se trata de trabajos de carga o descarga o para utilizar hasta en zonas de obra. Nuestra línea cubre cargas de hasta más de 6.000 kg en diferentes longitudes. El cuerpo principal-muy resistente, y su envoltura especial la dotan de una larga durabilidad, incluso con un uso continuado.

La solution idéale pour le levage sécurisé de tous type de charge: pour usages de charge, de décharge, même dans des zones de travaux. Notre gamme couvre des charges supérieures à 6.000 kg sur diverses longueurs. Le corps principal est très résistant, et sa constitution spéciale le dote d'une longue durée de vie, même à usage intensif.

Round slings are the ideal solution for the safe load lifting, as for loading, unloading or for use at a building site. In our range of products you can find various lengths of slings loading from 6.000 kg. The round sling protects lifted material. Its sturdy core and covering layer guarantee a long serviceable lift, even for continuous use.

La soluzione ideale per il sollevamento sicuro di ogni tipo di carico, sia che si tratti di lavori di carico o scarico, sia per l'utilizzo all'interno del cantiere. La nostra linea copre carichi superiori ai 6.000 kg, in diverse lunghezze. Il corpo principale molto resistente e la sua costituzione permettono di ottenere una lunga durata anche in uso continuato.

Ideal para o levantamento seguro de todo o tipo de cargas, tanto para carregamento como descarregamento ou também para ser utilizada em construção. A nossa linha tem diferentes tipos de comprimentos e cargas até 6.000 kg. O corpo principal é muito resistente e a sua cobertura especial proporciona uma longa durabilidade mesmo quando em uso contínuo.

Ref						
0860 1002		1 m	40 mm	6 mm	1.000 kg	<b>6,64</b>
0860 1004		2 m	40 mm	6 mm	1.000 kg	<b>12,79</b>
0860 1006		3 m	40 mm	6 mm	1.000 kg	<b>16,68</b>
0860 1010		5 m	40 mm	6 mm	1.000 kg	<b>31,01</b>
0860 2002		1 m	50 mm	7 mm	2.000 kg	<b>9,27</b>
0860 2004		2 m	50 mm	7 mm	2.000 kg	<b>16,21</b>
0860 2006		3 m	50 mm	7 mm	2.000 kg	<b>25,51</b>
0860 2010		5 m	50 mm	7 mm	2.000 kg	<b>44,11</b>

Ref						
0860 3002		1 m	60 mm	8 mm	3.000 kg	<b>11,89</b>
0860 3004		2 m	60 mm	8 mm	3.000 kg	<b>23,40</b>
0860 3006		3 m	60 mm	8 mm	3.000 kg	<b>34,06</b>
0860 3010		5 m	60 mm	8 mm	3.000 kg	<b>52,35</b>
0860 4004		2 m	70 mm	9 mm	4.000 kg	<b>32,58</b>
0860 4006		3 m	70 mm	9 mm	4.000 kg	<b>42,97</b>
0860 4010		5 m	70 mm	9 mm	4.000 kg	<b>68,57</b>
0860 6004		2 m	80 mm	12 mm	6.000 kg	<b>57,84</b>
0860 6006		3 m	80 mm	12 mm	6.000 kg	<b>84,23</b>
0860 6010		5 m	80 mm	12 mm	6.000 kg	<b>131,67</b>



CONJUNTO DE TRINCAJE GANCHO ABIERTO / SET SANGLE A CROCHETS OUVERTS / RATCHET STRAPS, OPEN HOOK  
SET TENDICINGHIA APERTO / CONJUNTO DE AMARRAÇÃO GANCHO ABERTO



Ref	↔	↕	⚠ max	📦
<b>0880 1500</b>	8 m	25 mm	1.500 kg	<b>11,70</b>
<b>0880 3000</b>	8 m	38 mm	3.000 kg	<b>18,90</b>
<b>0880 5000</b>	8 m	50 mm	5.000 kg	<b>21,60</b>
<b>0880 5001</b>	10 m	50 mm	5.000 kg	<b>28,85</b>
<b>0880 5002</b>	12 m	50 mm	5.000 kg	<b>31,25</b>
<b>0880 8000</b>	8 m	75 mm	8.000 kg	<b>75,90</b>



Ref	↔	↕	⚠ max	📦
<b>0880 1500A</b>	0,5 m	25 mm	1.500 kg	<b>5,95</b>
<b>0880 3000A</b>	0,5 m	38 mm	3.000 kg	<b>7,85</b>
<b>0880 5000A</b>	0,5 m	50 mm	5.000 kg	<b>11,35</b>



Ref	↔	↕	⚠ max	📦
<b>0880 1500B</b>	7,5 m	25 mm	1.500 kg	<b>6,25</b>
<b>0880 3000B</b>	7,5 m	38 mm	3.000 kg	<b>13,15</b>
<b>0880 5000B</b>	7,5 m	50 mm	5.000 kg	<b>15,30</b>

CONJUNTO DE TRINCAJE GANCHO CERRADO / SET SANGLE A CROCHETS FERMES / RATCHET STRAPS, CLOSED HOOK  
SET TENDICINGHIA CHIUSO / CONJUNTO DE AMARRAÇÃO GANCHO FECHADO



Ref	↔	↕	⚠ max	📦
<b>0890 1500</b>	8 m	25 mm	1.500 kg	<b>12,11</b>
<b>0890 3000</b>	8 m	38 mm	3.000 kg	<b>18,90</b>
<b>0890 5000</b>	8 m	50 mm	5.000 kg	<b>21,60</b>
<b>0890 5001</b>	10 m	50 mm	5.000 kg	<b>28,75</b>
<b>0890 5002</b>	12 m	50 mm	5.000 kg	<b>31,25</b>
<b>0890 8000</b>	8 m	75 mm	8.000 kg	<b>75,90</b>



Ref	↔	↕	⚠ max	📦
<b>0890 1500A</b>	0,5 m	25 mm	1.500 kg	<b>5,30</b>
<b>0890 3000A</b>	0,5 m	38 mm	3.000 kg	<b>7,85</b>
<b>0890 5000A</b>	0,5 m	50 mm	5.000 kg	<b>11,45</b>



Ref	↔	↕	⚠ max	📦
<b>0890 1500B</b>	7,5 m	25 mm	1.500 kg	<b>6,15</b>
<b>0890 3000B</b>	7,5 m	38 mm	3.000 kg	<b>12,95</b>
<b>0890 5000B</b>	7,5 m	50 mm	5.000 kg	<b>15,45</b>





**CONJUNTO DE TRINCAJE / SET SANGLE / RATCHET STRAPS  
SET TENDICINGHIA / CONJUNTO DE AMARRAÇÃO**

CINTA DE POLIÉSTER PARA TRINCAJES / SANGLE RUBAN / STRAPS, REEL  
CINGHIA IN POLIESTERE PER TENDICINGHIA / CINTA DE POLIÉSTER PARA AMARRAÇÃO

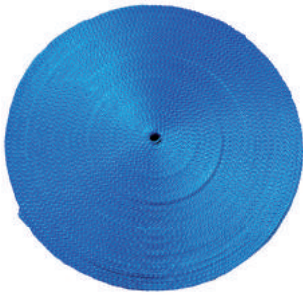

Ref	↔	↕	max	📦
<b>0870 0001</b>	100 m	25 mm	1.500 kg	<b>69,21</b>
<b>0870 0002</b>	100 m	38 mm	3.000 kg	<b>106,35</b>
<b>0870 0003</b>	100 m	50 mm	5.000 kg	<b>167,31</b>

CONJUNTO DE TRINCAJE "REVERSO" GANCHO ABIERTO / SET SANGLE A CROCHETS OUVERTS / RATCHET STRAPS, OPEN HOOK  
SET TENDICINGHIA APERTO / CONJUNTO DE AMARRAÇÃO GANCHO ABERTO

**REVERSO**

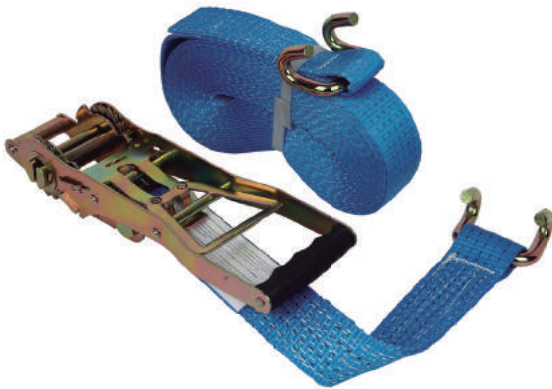

Ref	↔	↕	max	📦
<b>0880 5100</b>	9 m	50 mm	5000 kg	<b>31,30</b>

CONJUNTO DE TRINCAJE "REVERSO" GANCHO CERRADO / SET SANGLE A CROCHETS FERMES / RATCHET STRAPS, CLOSED HOOK  
SET TENDICINGHIA CHIUSO / CONJUNTO DE AMARRAÇÃO GANCHO FECHADO

**REVERSO**



Ref	↔	↕	max	📦
<b>0890 5100</b>	9 m	50 mm	5000 kg	<b>31,35</b>



CARRACA PARA TRINCAJE / CLIQUET A SANGLE / RATCHET STRAPS / DISPOSITIVO TENDICINGHIA / ROQUETE PARA AMARRAÇÃO

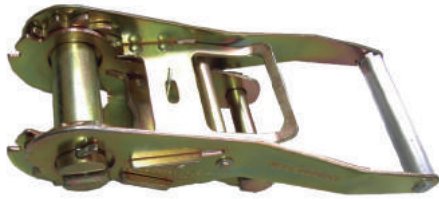

Ref	↔	↕	🏠 max	📦	📊	🚚
<b>0870 1500</b>	130 mm	25 mm	1.500 kg	1	<b>5,11</b>	✓
<b>0870 3000</b>	154 mm	38 mm	3.000 kg	1	<b>6,74</b>	✓
<b>0870 5000</b>	230 mm	50 mm	5.000 kg	1	<b>9,52</b>	✓

GANCHO ABIERTO PARA TRINCAJES / CROCHETS OUVERTS / OPEN HOOKS / GANCI PER TENDICINGHIA APERTI / GANCHO ABERTO



Ref	↕	🏠 max	📦	📊	🚚
<b>0870 0010</b>	25 mm	1.500 kg	1	<b>1,20</b>	✓
<b>0870 0011</b>	38 mm	3.000 kg	1	<b>1,91</b>	✓
<b>0870 0012</b>	50 mm	5.000 kg	1	<b>2,31</b>	✓

GANCHO CERRADO PARA TRINCAJES / CROCHETS FERMÉS / CLOSED HOOKS / GANCI PER TENDICINGHIA CHIUSI / GANCHO FECHADO



Ref	↕	🏠 max	📦	📊	🚚
<b>0870 0013</b>	25 mm	1.500 kg	1	<b>1,20</b>	✓
<b>0870 0014</b>	38 mm	3.000 kg	1	<b>1,91</b>	✓
<b>0870 0015</b>	50 mm	5.000 kg	1	<b>2,31</b>	✓

TENSOR CARRACA / TENDEUR À CLIQUET / RATCHET STRAP  
TENSORE A CRICCHETTO / CINTAS DE AMARRAÇÃO COM ROQUETE

1 PC



Ref	↔	↕	🏠 max	📦	📊	🚚
<b>0880 1001</b>	4 m	25 mm	500 kg	1	<b>5,85</b>	✓
<b>0880 1002</b>	5 m	25 mm	500 kg	1	<b>7,25</b>	✓
<b>0880 1003</b>	6 m	25 mm	500 kg	1	<b>7,40</b>	✓

TENSOR HEMBRILLA, 2 PZS / TENDEUR FEMELLE, 2 PCS / FEMALE STRAP, 2 PCS  
NASTRO TENSORE, 2 PZ / CINTAS DE AMARRAÇÃO COM FIVELA, 2 PÇS

PACK 2 PCS



Ref	↔	↕	🏠 max	📦	📊	🚚	Price x Pack
<b>0880 1004</b>	3 m	25 mm	500 kg	1	<b>7,60</b>	✓	
<b>0880 1005</b>	4 m	25 mm	500 kg	1	<b>9,55</b>	✓	
<b>0880 1006</b>	6 m	25 mm	500 kg	1	<b>10,70</b>	✓	



TRENZA DE POLIAMIDA - 8840 1 mm Ø (BLÍSTER) / POLYAMIDE TWIST - 8840 Ø 1 mm (BLISTER) / CORDE DE POLYAMIDE - 8840 Ø 1 mm (BLISTER)  
 CORDA IN POLIAMMIDE - 8840 1 mm Ø (BLISTER) / TRANÇADO POLIAMIDA - 8840 1 mm Ø (BLISTER)



ES Hilo trenzado en poliamida de gran flexibilidad y resistente al rozamiento. Indicado para albañilería, paquetería y bricolaje.

FR Fil tressé en polyamide d'une grande flexibilité et résistant aux frottements. Adapté pour la construction, l'emballage, et le bricolage.

EN Twisted polyamide thread. High flexibility and friction resistant, suitable for building, parcels and D.I.Y. works.

IT Poliammide intrecciato, altamente flessibile e resistente all'abrasione. Indicato per: muratura, imballaggi e bricolage.

PT Corda de poliamida trançada. Alta flexibilidade e resistente á fricção, adequado para construção, embalagens e bricolage.

Ref	Ø	☺	↔	📦	📦	📦	📦
<b>0810 1008</b>	1 mm	☐	50 m	35 kg	1	10	<b>2,56</b>
<b>0810 1009</b>	1 mm	☐	100 m	35 kg	1	10	<b>4,57</b>
<b>0810 1010</b>	1 mm	☐	200 m	35 kg	1	10	<b>8,95</b>

TRENCILLA POLIPROPILENO / CORDE DE POLYPROPYLÈNE / POLYPROPYLENE TWIST / CORDE IN POLIPROPILENO / FIO TORCIDO POLIPROPILENO



ES Hilo de albañil. Adecuado para albañilería, bricolaje, manualidades, paquetería, jardinería, etc.

FR Fil de maçon. Adapté pour la maçonnerie, le bricolage, les travaux manuels, les emballages, le jardinage, etc.

EN Building worker thread. Suitable for building, D.I.Y. work, handicraft, parcels, gardening, etc.

IT Filo muratore. Indicato per: lavori manuali, imballaggi, giardinaggio, muratura, ecc.

PT Fio de Obra. Indicado para a construção, bricolage, artesanato, embalagens, jardinagem, etc.

Ref	Ø	☺	↔	📦	📦	📦	📦
<b>0810 1000</b>	1,5 mm	🟠	100 m	48 kg	1	10	<b>5,12</b>
<b>0810 1001</b>	1,5 mm	☐	50 m	48 kg	1	10	<b>2,43</b>
<b>0810 1002</b>	1,5 mm	☐	100 m	48 kg	1	10	<b>4,52</b>
<b>0810 1003</b>	1,5 mm	☐	200 m	48 kg	1	10	<b>8,61</b>
<b>0810 1004</b>	1,5 mm	🔴	100 m	48 kg	1	10	<b>5,12</b>
<b>0810 1005</b>	1,5 mm	🟡	100 m	48 kg	1	10	<b>5,12</b>
<b>0810 1006</b>	1,5 mm	🟢	100 m	48 kg	1	10	<b>5,12</b>
<b>0810 1007</b>	1,5 mm	🟡	100 m	48 kg	1	10	<b>5,12</b>

RIEL TRENZADO DE POLIPROPILENO (CORTINAS), BLÍSTER / CORDON TRESSÉ DE POLYPROPYLÈNE (RIDEAUX), BLISTER  
 TWISTED POLYPROPYLENE RAIL (CURTAINS), BLISTER PACK / TRECCIA IN POLIPROPILENO (TENDE), BLISTER  
 ENTRANÇADOS POLIPROPILENO PARA CARRIL (CORTINAS), BLISTER



ES Adecuado para rieles de cortinas, bricolaje, construcción, jaulas, jardinería, etc.

FR Adepté pour les rails de rideaux, le bricolage, la construction, le jardinage, etc.

EN Suitable for curtains rails, do-it-yourself work, building, gardening cages, etc.

IT Indicato per: scorrimento tende, bricolage, costruzione, giardinaggio, ecc.

PT Indicado para trilhos de cortinas, bricolage, construção, gaiolas de jardim, etc.

Ref	Ø	☺	↔	📦	📦	📦	📦	📦
<b>0810 1051</b>	1 mm	☐	100 m	50 kg	1	10	<b>11,51</b>	✓
<b>0810 1011</b>	3 mm	☐	50 m	60 kg	1	10	<b>7,26</b>	✓



CUERDA TRENZADA HELICOIDAL (100% POLIPROPILENO) / CORDE TRESSÉE HÉLICOÏDALE (100% POLYPROPYLENE)  
 SPIRAL TWISTED CORD (POLYPROPYLENE 100%) / TRECCIA ELICOIDALE (100% POLIPROPILENO) / CORDA TRANÇADA HELICOIDAL (100% POLIPROPILENO)

ES Realizadas con alma trenzada en 8 cabos, resistente a los rayos solares, a la tracción, al roce y al agua. Flexibilidad y suavidad al tacto.

FR Fabriquée avec une trame tressée sur 8 extrémités, résistante aux rayons solaires, à la traction, au frottement et à l'eau. Flexibilité et douceur au toucher.

EN Twisted core made from 8 strands. Sunbeam, traction, friction and water resistant. Flexibility and smoothness to the touch.

IT Realizzata internamente con 8 fili intrecciati, resistente ai raggi solari, alla trazione, allo sfregamento e all'acqua. Flessibilità e morbidezza al tatto.

PT Feitas com alma trançada em 8 cabos, resistente aos raios solares, à tração, à fricção e à água. Flexível e suave ao tacto.

Rollo grande / Rouleau grand format / Big roll  
 Rotolo grande / Rolo grande



Ref	Ø		↔	↔	📦	📦
0810 1023	6 mm	🟡🔴	200 m	600 kg	1	83,57
0810 1024	6 mm	🟩🟩	200 m	600 kg	1	83,57
0810 1025	6 mm	🟩🟦	200 m	600 kg	1	83,57
0810 1026	8 mm	🟡🔴	200 m	800 kg	1	136,87
0810 1027	8 mm	🟩🟩	200 m	800 kg	1	136,87
0810 1028	8 mm	🟩🟦	200 m	800 kg	1	136,87
0810 1029	10 mm	🟡🔴	100 m	1200 kg	1	102,34
0810 1030	10 mm	🟩🟩	100 m	1200 kg	1	102,34
0810 1031	10 mm	🟩🟦	100 m	1200 kg	1	102,34
0810 1032	12 mm	🟡🔴	100 m	1800 kg	1	137,73
0810 1033	12 mm	🟩🟩	100 m	1800 kg	1	137,73
0810 1034	12 mm	🟩🟦	100 m	1800 kg	1	137,73
0810 1035	14 mm	🟡🔴	100 m	2400 kg	1	185,48
0810 1036	14 mm	🟩🟩	100 m	2400 kg	1	185,48
0810 1037	14 mm	🟩🟦	100 m	2400 kg	1	185,48
0810 1038	16 mm	🟡🔴	100 m	3000 kg	1	242,20
0810 1039	16 mm	🟩🟩	100 m	3000 kg	1	242,20
0810 1040	16 mm	🟩🟦	100 m	3000 kg	1	242,20

Rollo pequeño / Rouleau petit format / Small roll  
 Rotolo piccolo / Rolo pequeño



Ref	Ø		↔	↔	📦	📦
0810 1023A	6 mm	🟡🔴	100 m	600 kg	1	46,90
0810 1024A	6 mm	🟩🟩	100 m	600 kg	1	46,90
0810 1025A	6 mm	🟩🟦	100 m	600 kg	1	46,90
0810 1026A	8 mm	🟡🔴	50 m	800 kg	1	40,93
0810 1027A	8 mm	🟩🟩	50 m	800 kg	1	40,93
0810 1028A	8 mm	🟩🟦	50 m	800 kg	1	40,93
0810 1029A	10 mm	🟡🔴	50 m	1200 kg	1	56,28
0810 1030A	10 mm	🟩🟩	50 m	1200 kg	1	56,28
0810 1031A	10 mm	🟩🟦	50 m	1200 kg	1	56,28
0810 1032A	12 mm	🟡🔴	50 m	1800 kg	1	74,62
0810 1033A	12 mm	🟩🟩	50 m	1800 kg	1	74,62
0810 1034A	12 mm	🟩🟦	50 m	1800 kg	1	74,62
0810 1035A	14 mm	🟡🔴	50 m	2400 kg	1	97,22
0810 1036A	14 mm	🟩🟩	50 m	2400 kg	1	97,22
0810 1037A	14 mm	🟩🟦	50 m	2400 kg	1	97,22
0810 1038A	16 mm	🟡🔴	25 m	3000 kg	1	68,65
0810 1039A	16 mm	🟩🟩	25 m	3000 kg	1	68,65
0810 1040A	16 mm	🟩🟦	25 m	3000 kg	1	68,65





CUERDA TRENZADA POLIPROPILENO (ROLLOS) / CORDE TRESSÉE POLYPROPYLENE (ROULEAUX) / TWISTED POLYPROPYLENE CORD (ROLLS)  
TRECCIA IN POLIPROPILENE (ROTOLO) / CORDA TRANÇADA DE POLIPROPILENO (ROLOS)

ES Realizadas con alma trenzada en 8 cabos y el exterior en 24 cabos, resistente a los rayos solares, a la tracción, al roce y al agua. Indicada para bombas sumergibles, náutica, construcción, etc.

FR Fabriquée avec une trame tressée sur 8 extrémités et l'extérieur sur 24 extrémités, résistante aux rayons solaires, à la traction, au frottement et à l'eau. Indiquée pour les pompes submersibles, le secteur nautique, construction, etc.

EN Twisted core made from 8 strands and exterior from 24 strands. Sunbeam, traction, friction and water resistant. It is used for submerible pumps, seafaring, construction, etc.

IT Realizzata internamente con 8 fili intrecciati ed esternamente con 24 fili, resistente ai raggi solari, alla trazione, allo sfregamento e all'acqua. Indicata per boe sommergibili, nel settore nautico, nelle costruzioni, ecc.

PT Feito com alma trançada em oito camadas e o exteriores em 24, resistente a luz solar, tração, fricção e água. Adequado para bombas submersíveis, náutica, construção, etc.



Rollo grande / Rouleau grand format / Big roll  
Rotolo grande / Rolo grande

Ref	Ø		↔			
<b>0810 1015</b>	6 mm		200 m	400 kg	1	<b>75,90</b>
<b>0810 1016</b>	8 mm		200 m	800 kg	1	<b>126,43</b>
<b>0810 1017</b>	10 mm		100 m	1200 kg	1	<b>95,51</b>
<b>0810 1018</b>	12 mm		100 m	1800 kg	1	<b>130,05</b>
<b>0810 1019</b>	14 mm		100 m	2400 kg	1	<b>169,71</b>
<b>0810 1020</b>	16 mm		100 m	3000 kg	1	<b>227,27</b>
<b>0810 1021</b>	18 mm		100 m	3900 kg	1	<b>275,45</b>
<b>0810 1022</b>	20 mm		100 m	4800 kg	1	<b>355,62</b>

Rollo pequeño / Rouleau petit format / Small roll  
Rotolo piccolo / Rolo pequeño

Ref	Ø		↔			
<b>0810 1015A</b>	6 mm		100 m	400 kg	1	<b>43,07</b>
<b>0810 1016A</b>	8 mm		50 m	800 kg	1	<b>38,38</b>
<b>0810 1017A</b>	10 mm		50 m	1200 kg	1	<b>52,67</b>
<b>0810 1018A</b>	12 mm		50 m	1800 kg	1	<b>70,36</b>
<b>0810 1019A</b>	14 mm		50 m	2400 kg	1	<b>87,50</b>
<b>0810 1020A</b>	16 mm		25 m	3000 kg	1	<b>65,03</b>
<b>0810 1021A</b>	18 mm		20 m	3900 kg	1	<b>63,75</b>
<b>0810 1022A</b>	20 mm		15 m	4800 kg	1	<b>62,47</b>

Madeja / Blister / Braided / Blister / Blister



Ref	Ø		↔			
<b>0810 1015B</b>	6 mm		10 m	480 kg	1	<b>6,05</b>
<b>0810 1016B</b>	8 mm		10 m	800 kg	1	<b>9,20</b>
<b>0810 1017B</b>	10 mm		10 m	1200 kg	1	<b>13,04</b>
<b>0810 1201B</b>	6 mm		10 m	600 kg	1	<b>6,05</b>
<b>0810 1202B</b>	6 mm		10 m	600 kg	1	<b>6,05</b>
<b>0810 1203B</b>	6 mm		10 m	600 kg	1	<b>6,05</b>
<b>0810 1204B</b>	6 mm		10 m	600 kg	1	<b>6,05</b>
<b>0810 1205B</b>	8 mm		10 m	800 kg	1	<b>9,20</b>
<b>0810 1206B</b>	8 mm		10 m	800 kg	1	<b>9,20</b>
<b>0810 1207B</b>	8 mm		10 m	800 kg	1	<b>9,20</b>
<b>0810 1208B</b>	8 mm		10 m	800 kg	1	<b>9,20</b>
<b>0810 1209B</b>	10 mm		10 m	1200 kg	1	<b>13,04</b>
<b>0810 1210B</b>	10 mm		10 m	1200 kg	1	<b>13,04</b>
<b>0810 1211B</b>	10 mm		10 m	1200 kg	1	<b>13,04</b>
<b>0810 1212B</b>	10 mm		10 m	1200 kg	1	<b>13,04</b>





CUERDA DE NYLON MATE 4 CABOS / CORDE 4 EXTRÉMITÉS / 4 STRANDS SISAL CORD / CORDA IN NYLON / CORDA NYLON MATE 4 FIOS

ES Cuerdas de multifilamentos de nylon torcidas a 4 cabos sin alma. No se deteriora con el agua (no flota). Adecuada para náutica, amarres de redes, pesca, agricultura, transporte, etc.

FR Corde de multi filaments de nylon courbée á 4 extrémités sans trame. Ne se détériore pas avec l'eau (Ne flotte pas). Adapté pour les amarrages de bateaux, la pêche, l'agriculture, le transport, etc.

EN Multi-threads nylon bent cords. 4 strands without core. Indestructible by water (it doesn't float). Suitable for navigation, meshes, fishing, agriculture, transport, etc.

IT Corda in nylon (multifilamento) senza anima. Non si deteriora con l'acqua (non galleggia). Indicata per: trasporto, settore nautico, pesca, ormeggi, agricoltura, ecc.

PT Cordas de nylon mate, cordas torcidas sem alma a 4 fios. Não se deteriora com água (não flutuar). Indicado para náutica, amarrações de redes, pesca, agricultura, transporte, etc.



Rollo grande / Rouleau grand format / Big roll / Rotolo grande / Rolo grande

Ref	∅	↔	📦	📦	📦
<b>0810 1041</b>	6 mm	200 m	450 kg	1	<b>46,90</b>
<b>0810 1042</b>	8 mm	200 m	900 kg	1	<b>86,99</b>
<b>0810 1043</b>	10 mm	100 m	1400 kg	1	<b>53,52</b>
<b>0810 1044</b>	12 mm	100 m	2000 kg	1	<b>78,88</b>
<b>0810 1045</b>	14 mm	100 m	2600 kg	1	<b>98,72</b>
<b>0810 1046</b>	16 mm	100 m	3300 kg	1	<b>145,83</b>
<b>0810 1047</b>	18 mm	100 m	4100 kg	1	<b>184,33</b>
<b>0810 1048</b>	20 mm	100 m	5000 kg	1	<b>220,32</b>



Rollo pequeño / Rouleau petit format / Small roll / Rotolo piccolo / Rolo pequeño

Ref	∅	↔	📦	📦	📦
<b>0810 1041A</b>	6 mm	100 m	450 kg	1	<b>31,98</b>
<b>0810 1042A</b>	8 mm	50 m	900 kg	1	<b>28,83</b>
<b>0810 1043A</b>	10 mm	50 m	1400 kg	1	<b>35,78</b>
<b>0810 1044A</b>	12 mm	50 m	2000 kg	1	<b>48,36</b>
<b>0810 1045A</b>	14 mm	50 m	2600 kg	1	<b>61,26</b>
<b>0810 1046A</b>	16 mm	25 m	3300 kg	1	<b>45,14</b>
<b>0810 1047A</b>	18 mm	20 m	4100 kg	1	<b>44,55</b>
<b>0810 1048A</b>	20 mm	15 m	5000 kg	1	<b>40,54</b>



Madeja / Blister / Braided / Blister / Blister

Ref	∅	↔	📦	📦	📦
<b>0810 1041B</b>	6 mm	10 m	450 kg	1	<b>4,65</b>
<b>0810 1042B</b>	8 mm	10 m	900 kg	1	<b>6,70</b>
<b>0810 1043B</b>	10 mm	10 m	1400 kg	1	<b>8,18</b>



CUERDAS ELÁSTICAS (LÁTEX 1ª) / CORDES ÉLASTIQUES (LATEX 1ER) / ELASTIC CORDS (TOP QUALITY LATEX)  
CORDE ELASTICHE (LATEX DI PRIMA QUALITÀ) / CORDAS ELÁSTICAS (LÁTEX 1ª)

ES Cuerda elástica trenzada en poliéster de alta tenacidad. Resistente a rayos solares, alma en látex de primera calidad. Indicado para toldos de camiones, remolques, piscinas, maquinaria agrícola e invernaderos.

FR Corde élastique tressée en polyester de haute résistance. Résistante aux rayons solaires, trame en latex de première qualité. Indiquée pour les bâches de camions, les remorques, les piscines, les machines agricoles et les serres.

EN Elastic twisted cord. High toughness polyester. Resistant to sunbeams, top quality latex core. Suitable for truck-sunblinds, tows, swimming-pools, agricultural machinery and greenhouses.

IT Treccia elastica in poliester ad alta resistenza ai raggi solari, anima in latex di prima qualità. Indicata per tende di camion, rimorchi, piscine, macchinari agricoli e serre.

PT Corda elástica em poliéster trançada e de látex de 1ª qualidade. Resistente à luz solar, a alma de látex. Adequado para os toldos do caminhão, reboques, piscinas, máquinas agrícolas e estufas.



Rollo grande / Rouleau grand format / Big roll  
Rotolo grande / Rolo grande

Ref	∅	↔	📦	📊
<b>0810 1077</b>	6 mm	200 m	1	<b>207,48</b>
<b>0810 1078</b>	8 mm	200 m	1	<b>281,00</b>
<b>0810 1079</b>	10 mm	100 m	1	<b>211,07</b>
<b>0810 1190</b>	12 mm	100 m	1	<b>352,21</b>



Rollo pequeño / Rouleau petit format / Small roll  
Rotolo piccolo / Rolo pequeño

Ref	∅	↔	📦	📊
<b>0810 1077A</b>	6 mm	100 m	1	<b>108,54</b>
<b>0810 1078A</b>	8 mm	50 m	1	<b>76,75</b>
<b>0810 1079A</b>	10 mm	50 m	1	<b>110,86</b>
<b>0810 1190A</b>	12 mm	25 m	1	<b>96,79</b>



Madeja / Blister / Braided / Blister / Blister

Ref	∅	↔	📦	📊
<b>0810 1077B</b>	6 mm	10 m	1	<b>11,68</b>
<b>0810 1078B</b>	8 mm	10 m	1	<b>16,41</b>
<b>0810 1079B</b>	10 mm	10 m	1	<b>24,13</b>



CORDÓN TRENZADO POLIPROPILENO (PERSIANAS) Ø 5 mm / CORDON TRESSÉ DE POLYPROPYLENE (PERSIENES) 5 mm  
 TWISTED POLYPROPYLENE CORD (SLATTED SHUTTER) 5 mm / CORDONE INTRECCIATO IN POLIPROPILENE (PERSIANE) 5 mm  
 CORDÃO TRANÇADO POLIPROPILENO (PERSIANAS) mm



ES Cordón trenzado con polipropileno en el exterior y alma texturizada. Adecuado para persianas, toldos, redes, invernaderos, etc.

FR Cordon tressé avec polypropylène à l'extérieur. Adapté pour les persiennes, les bâches, les serres, etc.

EN Twisted cord polypropylene coated and textured core. Suitable for slatted shutters, sunblinds, meshes, greenhouses, etc.

IT Cordone intrecciato con polipropilene all'esterno e tessuto all'interno. Indicato per persiane, tende, reti, serre, ecc.

PT Cordão trançado com polipropileno no exterior e alma com textura. Indicado para persianas, toldos, redes, estufas, etc.



Rollo / Rouleau / Roll / Rotolo / Rolo

Ref	Ø	☺	↔	📦	📦	📦	📦
0810 1012	5 mm	☐	200 m	200 kg	1	7	27,72
0810 1013	5 mm	☐	200 m	200 kg	1	7	27,72
0810 1014	5 mm	☐	200 m	200 kg	1	7	27,72
0810 1101	5 mm	☐	200 m	200 kg	1	7	27,72
0810 1102	5 mm	☐	200 m	200 kg	1	7	27,72



Blisters

Ref	Ø	☺	↔	📦	📦	📦	📦
0810 1120	5 mm	☐	10 m	200 kg	1	3,37	✓
0810 1121	5 mm	☐	15 m	200 kg	1	4,10	✓
0810 1122	5 mm	☐	20 m	200 kg	1	4,91	✓
0810 1123	5 mm	☐	25 m	200 kg	1	5,63	✓
0810 1130	5 mm	☐	10 m	200 kg	1	3,37	✓
0810 1131	5 mm	☐	15 m	200 kg	1	4,10	✓
0810 1132	5 mm	☐	20 m	200 kg	1	4,91	✓
0810 1133	5 mm	☐	25 m	200 kg	1	5,63	✓
0810 1140	5 mm	☐	10 m	200 kg	1	3,37	✓
0810 1141	5 mm	☐	15 m	200 kg	1	4,10	✓
0810 1142	5 mm	☐	20 m	200 kg	1	4,91	✓
0810 1143	5 mm	☐	25 m	200 kg	1	5,63	✓

CUERDA ESPECIAL DE ARRANQUE / CORDE SPÉCIALE DE DÉMARRAGE / SPECIAL STARTING CORD  
 CORDA SPECIALE DI AVVIAMENTO / CORDA ESPECIAL DE ARRANQUE



ES Palangre de poliamida 100%. Cordón redondo con una gran resistencia a la fricción y a la tracción.

FR Bobine de corde 100% polyamide. Corde ronde avec haute résistance à la friction et la traction.

EN 100% Polyamide cord. Round cord with great resistance to the friction and traction.

IT Corda di 100% poliammide. Cordone rotondo con un'elevata resistenza alla trazione.

PT 100% Poliamida. Corda redonda com grande resistência á fricção e á tração.

Ref	Ø	↔	📦	📦	📦
0810 1052	2,5 mm	100 m	245 kg	1	23,23
0810 1053	3 mm	100 m	280 kg	1	30,58
0810 1054	4 mm	100 m	320 kg	1	37,13
0810 1055	5 mm	100 m	400 kg	1	50,23

Madeja / Blister / Braided / Blister / Blister

Ref	Ø	↔	📦	📦	📦
0810 1052B	2,5 mm	5 m	245 kg	1	2,26
0810 1053B	3 mm	5 m	280 kg	1	2,48
0810 1054B	4 mm	5 m	320 kg	1	3,29
0810 1055B	5 mm	5 m	400 kg	1	3,96

MADEJA CUERDA PLÁSTICO POLIETILENO 4 CABOS / BLISTER CORDE EN PLASTIQUE / PLASTIC CORD SKEIN  
BLISTER CORDA IN PLASTICA / BLÍSTER CORDA PLÁSTICO

ES Cuerda compuesta por monofilamentos de polietileno torcidos a 4 cabos. Al ser fibras sintéticas es resistente al agua y tiene flotabilidad. Indicada para: tendaderos, persianas, náutica, pesca, etc.

FR Corde composée de monofilaments de polyéthylène torsadés aux 4 extrémités. Comme il s'agit de fibres synthétiques, elle est résistante à l'eau et possède une bonne flottabilité. Convient pour : cordes à linge, stores, nautisme, pêche, etc.

EN Cord consisting of 4 twisted strands made of polyethylene monofilaments. As they are synthetic fibres, they are water resistant and have buoyancy. Suitable for: clothes lines, blinds, nautical uses, fishing, etc.

IT Corda composta da monofilamenti in polietilene intrecciati a 4 estremità. Sintetico è resistente all'acqua e ha galleggiabilità. Adatto per: stendibiancheria, tapparelle, nautica, pesca, ecc.

PT Corda composta de monofilamentos de polietileno torcidos para 4 pontas. Sintético é resistente à água e tem fluabilidade. Adequado para: varais, persianas, náutica, pesca, etc.



Ref	∅	🌀	↔	📦	📦	📦
0810 1221B	5 mm	□	10 m	200 kg	1	2,09
0810 1222B	5 mm	■	10 m	200 kg	1	2,09
0810 1223B	5 mm	■	10 m	200 kg	1	2,09
0810 1224B	5 mm	■	10 m	200 kg	1	2,09

## BOBINA CUERDA PAPEL / BOBINE CORDE PAPIER / PAPER CORD REEL / BOBINA CORDA CARTA / CARRETEL CORDA PAPEL



ES Cuerda ecológica de papel, para manualidades, asas de bolsas, asientos, paquetería, bricolaje, etc.

FR Corde en papier écologique pour l'artisanat, poignées pour sacs, sièges, colis, bricolage, etc.

EN Ecological paper cord suitable for crafts, bag handles, seats, parcels, DIY works, etc.

IT Corda di carta ecologica, per l'artigianato, manici di borse, sedili, pacchi, fai da te, ecc.

PT Corda de papel ecológico, para artesanato, alças de bolsas, assentos, pacotes, bricolagem, etc.

Ref	∅	↔	📦	📦
0810 1231	2 mm	50 m	1	6,05

BOBINA HILO YUTE N°2 (1,5 mm) / BOBINE FIL JUTE N°2 1,5mm / JUTE TWINE REEL N°2 1,5mm NATURAL  
BOBINA FILO JUTA N°2 1,5mm / CARRETEL FIO JUTA N°2 1,5mm

ES Hilo de yute natural para floristería, tarjetas de boda, bricolaje, manualidades, trabajos ecuestres, etc. Suave al tacto con un aspecto rústico.

FR Fil de jute naturel pour fleurs, cartes de mariage, bricolage, artisanat, travaux équestres, etc... Doux au toucher avec un look rustique.

EN Natural jute thread suitable for flower shops, wedding cards, DIY works, crafts, equestrian works, etc. Soft to the touch with a rustic look.

IT Filo di juta natural per fioristi, carte di nozze, bricolage, artigianato, lavori equestre, ecc. Morbido al tatto con un aspetto rustico.

PT Fio de juta natural para florista, cartões de casamento, bricolagem, artesanato, trabalhos equestres, etc. Suave ao toque com uma aparência rústica.

Ref	∅	📦	📦	📦
0810 1233	1,5 mm	50 g	1	2,08
0810 1234	1,5 mm	100 g	1	3,67





CUERDA DE SISAL 4 CABOS / CORDE 4 EXTRÉMITÉS / 4 STRANDS SISAL CORD / CORDA SISAL, 4 FILI / CORDA DE SISAL 4 FIOS



ES Cuerda de sisal torcida a 4 cabos sin alma en fibra natural, muy flexible obtenida de la pita. Indicada para decoración, deportes, manualidades, agricultura, construcción, etc.

FR Corde courbée à 4 extrémités sans trame, en fibre naturelle. Adaptée pour la décoration, les sports, les travaux manuels, l'agriculture, la construction, etc.

EN Sisal 4 strands bent cord without natural fibre core, very flexible. Made from pita fibre. Suitable for decoration, sports, handicraft, agriculture, building works, etc.

IT Treccia in sisal senza anima in fibre naturali, molto flessibile. Indicata per: decorazioni, sport, artigianato, agricoltura, costruzioni, ecc.

PT Corda de sisal torcida com quatro camadas de fibra natural sem alma, muito flexível, obtido a partir da pita, obtido a partir da pita. Apropriado para a decoração, esportes, artesanato, agricultura, construção, etc.

Ref	Ø	↔	📦	📦	📦
<b>0810 1057</b>	6 mm	200 m	260 kg	1	<b>108,73</b>
<b>0810 1058</b>	8 mm	100 m	480 kg	1	<b>67,80</b>
<b>0810 1059</b>	10 mm	100 m	630 kg	1	<b>96,93</b>
<b>0810 1060</b>	12 mm	100 m	960 kg	1	<b>142,84</b>
<b>0810 1061</b>	14 mm	100 m	1250 kg	1	<b>197,70</b>
<b>0810 1062</b>	16 mm	100 m	1700 kg	1	<b>258,54</b>
<b>0810 1063</b>	18 mm	100 m	2100 kg	1	<b>316,42</b>
<b>0810 1064</b>	20 mm	100 m	2850 kg	1	<b>409,14</b>

Ref	Ø	↔	📦	📦	📦
<b>0810 1057A</b>	6 mm	100 m	260 kg	1	<b>64,18</b>
<b>0810 1058A</b>	8 mm	50m	480 kg	1	<b>43,71</b>
<b>0810 1059A</b>	10 mm	50 m	630 kg	1	<b>59,27</b>
<b>0810 1060A</b>	12 mm	50 m	960 kg	1	<b>82,09</b>
<b>0810 1061A</b>	14 mm	50 m	1250 kg	1	<b>111,94</b>
<b>0810 1062A</b>	16 mm	25 m	1700 kg	1	<b>76,75</b>
<b>0810 1063A</b>	18 mm	25 m	2100 kg	1	<b>91,68</b>
<b>0810 1064A</b>	20 mm	25 m	2850 kg	1	<b>115,13</b>

CUERDA EN BOBINAS (750 g) DE SISAL / CORDE EN BOBINE (750 g) / SISAL REEL CORD (750 g) / ROTOLO CORDA IN SISAL (750 g) / CORDA EM BOBINAS (750 g) DE SISAL



ES Cuerda de fibras naturales torcidas a 2 y 3 cabos, resistentes y gran seguridad en el nudo. Indicadas para paquetería, bricolaje, agricultura, manualidades, ganadería, sillería, etc.

FR Corde de fibres naturelles courbée à 2 et 3 extrémités, résistantes, grande sécurité pour les noeuds. Adaptée pour les emballages, le bricolage, l'agriculture, le travail, fermier, etc.

EN Natural fibre sisal bent cord. 2 and 3 resistant strands, secure knot. Suitable for parcels, do-it-yourself work, agriculture, handicraft, cattle raising, chairmaking, etc.

IT Corda in fibra naturale da 2 e 3 filamenti, resistente e sicura nei nodi. Indicata per: imballaggi, bricolage, agricoltura, artigianato, bestiame (fattorie), ecc.

PT Corda de Sisal em bobinas com fibra natural torcida a 2 e 3 camadas, resistente e com grande segurança no nó. Apropriado para a embalagem, Bricolage, a agricultura, o artesanato, a agricultura, alvenaria, etc.

Ref	📦	📦	📦	📦	📦
<b>0810 1065</b>	2 Cabos	100 kg	750 g	1	12 <b>12,89</b>
<b>0810 1066</b>	3 Cabos	120 kg	750 g	1	12 <b>12,89</b>

BLÍSTER SISAL PITA 2 CABOS / BLISTER SISAL PITA 2 EXTRÉMITÉS / BLISTER SISAL PITA 2 STRANDS / BLISTER SISAL PITA, 2 FILI / CORDA SISAL 4 CABOS



Ref	📦	📦	📦	📦	📦
<b>0810 1065A</b>	2 Cabos	100 kg	200 g	1	10 <b>4,86</b>





CORDÓN TRENZADO HIPPIE / CORDE TRESSÉE HIPPIE / HIPPIE SPIRAL TWISTED CORD / CORDA INTRECCATA HIPPIE / CORDÃO ENTRAÇADO HIPPIE

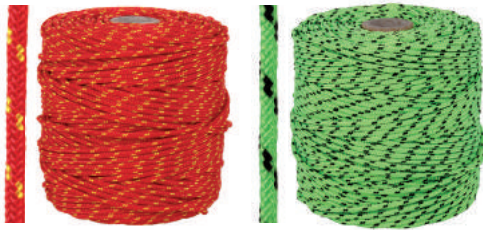

ES Cordon trenzado con alma y camisa exterior de poliamida. Indicado para manualidades, llaveros, pulseras, colgantes, pesca, cangrejas, deportes.

FR Corde tressée avec trame et tissage extérieur en polyamide. Indiqué pour travaux manuel, porte-clés, bracelets, pendentifs, pêche, crabier, sports.

EN Spiral twisted cord with core and exterior made from polyamide. Suitable for crafts, key chains, bracelets, necklaces, fishing, sports.

IT Corda intrecciata con anima e camicia esterna in poliammide. Adatto per lavori manuali, portachiavi, bracciali, ciondoli, pesca, sandali, sport.

PT Cordão entraçado com alma interior e revestimento exterior de poliamido, indicado para trabalhos manuais, porta-chaves, pulseiras, colares, pesca, redes de pesca e desporto.

Rollo grande / Rouleau grand format / Big roll  
Rotolo grande / Rolo grande

Ref	Ø	↻	↔	⬛	📦	📦	📦
0810 1150	3 mm	⬛	100 m	290 kg	1	29,64	
0810 1151	3 mm	🟡	100 m	290 kg	1	29,64	
0810 1152	3 mm	🔴	100 m	290 kg	1	29,64	
0810 1153	3 mm	🟢	100 m	290 kg	1	29,64	

Rollo pequeño / Rouleau petit format / Small roll  
Rotolo piccolo / Rolo pequeño

Ref	Ø	↻	↔	⬛	📦	📦	📦
0810 1150A	3 mm	⬛	25 m	290 kg	1	10	8,10
0810 1151A	3 mm	🟡	25 m	290 kg	1	10	8,10
0810 1152A	3 mm	🔴	25 m	290 kg	1	10	8,10
0810 1153A	3 mm	🟢	25 m	290 kg	1	10	8,10

HILOS DE RAFIA SINTÉTICA / FILS DE RAPHIA SYNTHÉTIQUE / SYNTHETIC RAFFIA BENT THREADS  
FILI DI RÀFIA SINTETICA / FIO DE RÁFIA SINTÉTICA



ES Hilo de rafia sintética torcida a 1 cabo, derivada del polipropileno. Indicada para paquetería, bricolaje, industria, agricultura, manualidades, etc. Aprox. 600m/kg.

FR Fil de raphia synthétique courbé à 1 extrémité, dérivé du polypropylène. Adapté pour l'emballage, le bricolage, l'agriculture les travaux manuels, etc.

EN Synthetic raffia bent thread, 1 strand, polypropylene product. Suitable for parcels, do-it-yourself work, industry, agriculture, handicraft, etc. Aprox. 600m/kg.

IT Filo di ràfia sintetica avvolta in un tubo, derivata dal polipropileno. Indicata per: imballaggi, bricolage, industria, agricoltura, ecc.

PT Fio de ráfia sintética trançada em 1 fio, derivado de polipropileno. Apropriado para a embalagem, Bricolage, indústria, agricultura, artesanato, etc. Aprox. 600m/kg.

Ref	↻	⬛	📦	📦	📦	📦
0810 1067	🟩	60 kg	750 g	1	12	8,95
0810 1068	🟢	60 kg	750 g	1	12	9,17
0810 1069	🔵	60 kg	750 g	1	12	9,17
0810 1070	🔴	60 kg	750 g	1	12	9,17
0810 1071	🟡	60 kg	750 g	1	12	9,17
0810 1090	⬛	60 kg	750 g	1	12	9,17



BLÍSTER HILO RAFIA / BLISTER FIL RAFIA / BLISTER RAFFIA THREAD / BLISTER FILO DI RÀFIA / EMBALAGEM FIO RÁFIA



Ref						
0810 1067A		60 kg	200 g	1	10	3,84
0810 1090A		60 kg	200 g	1	10	3,85

CUERDA DE PLÁSTICO TORCIDO 4 CABOS (MOD. TELEFÓNICA) / CORDE PLASTIQUE COURBÉE 4 EXTRÉMITÉS (TÉLÉPHONE)  
4 TWISTED STRANDS PLASTIC ROPE (TELEPHONE) / CORDA DI PLASTICA RITORTA A 4 CAVI (TELEFONIA)  
CORDA DE PLÁSTICO TORCIDA DE 4 CABOS (TELEFÔNICA)



ES Cuerda de plástico torcido de 4 cabos para mandrilar. Indicada para su uso en guías de cable o fibra óptica.

FR Corde plastique courbée de 4 extrémités pour aléser, indiquée pour une utilisation de guides de câbles ou fibre optique.

EN 4 twisted strands plastic rope indicated for use in cable rails or optical fibre.

IT Corda di plastica ritorta a 4 cavi, indicato per l'uso nelle guide dei cavi o per la fibra ottica.

PT Corda de plástico torcida de 4 cabos de enrolar, indicado para uso em guias de cabos ou fibra óptica.

Ref					
0810 1170	5 mm	500 m	280 kg	1	75,30

TRENZADO DE POLIÉSTER ALTA TENACIDAD SIN ALMA / CORDE DE POLYESTER HAUTE RESISTANCE SANS TRAME  
HIGH TOUGHNESS TWISTED POLYESTER WITHOUT CORE / CORDA IN POLIESTERE, ALTA RESISTENZA, SENZA ANIMA  
TRANÇADO DE POLIÉSTER DE ALTA TENACIDADE, SEM ALMA



ES Cuerda trenzada en un granete de 16 cabos 100% poliéster de alta tenacidad. Gran resistencia al agua y a los rayos solares lo que la convierte en una cuerda ideal para exterior. Indicada para invernaderos, tendedores, persianas, toldos, amarres, náutica, etc.

FR Corde 100% polyester de haute résistance. Grande résistance à l'eau et aux rayons solaires, c'est une corde idéale pour l'extérieur. Adaptée pour les serres, persiennes, bâches, amarrages, nautique, etc.

EN Twisted cord, 16 strands. High toughness, 100% polyester. Water and sunbeam resistant, ideal for exterior. Suitable for greenhouses, clothes-lines, slatted shutters, sunblinds, fastening, navigation, etc.

IT Corda 100% poliester ad alta resistenza ai raggi solari e all'acqua rendendola ideale per l'esterno. Indicata per: serre, persiane, tende, ormeggi, settore nautico, ecc.

PT Corda trançada 100% de poliéster de alta tenacidade e sem alma. 16 camadas trançadas, altamente resistente a água e luz solar tornando-a ideal para o exterior. Indicado para estufas, estendais, persianas, toldos, amarração, náutica, etc.

Ref						
0810 1049	5 mm	200 m	490 kg	1	7	39,75
0810 1050	6 mm	200 m	780 kg	1	7	53,29

HILO BRAMANTE CÁÑAMO Nº 5 / FIL BORDÉ CHANVRE Nº 5 / TWINE THREAD. HEMP NO. 5 / FILO CANAPA Nº 5 / CORDEL CÂNHAMO Nº5



ES Hilo pulido bramante. Fibra natural flexible obtenida de la planta del cáñamo. Indicada para manualidades, bricolaje, embutidos, carpintería, paquetería, etc.

FR Fil poli. Fibre naturelle flexible obtenue de la plante du chanvre. Adapté pour les travaux manuels, le bricolage, les marqueteries, la menuiserie, les emballages, etc.

EN Polished twine thread. Flexible natural fibre from hemp plant. Suitable for handicraft, do-it-yourself work, sausages, woodwork, parcels, etc.

IT Filo di spago lucido, in fibra naturale (flessibile) ottenuta dalla pianta di canapa. Adatto per: artigianato, bricolage, falegnameria, imballaggi, ecc.

PT Cordel polido obtido a partir do cânhamo. Indicado para artesanato, Bricolage, frios, carpintaria, embalagens, etc.

Ref							
0810 1072	1 mm	Natural	50 g	1	10	2,65	✓
0810 1073	1 mm	Natural	100 g	1	10	4,47	✓



BOBINA HILO DE ALGODÓN / PELOTE DE COTON / COTTON BALL / BLISTER BOBINA FILTO DI COTONE / BOBINE FIO DE ALGODAO



ES Hilos de algodón en ovillo. Indicado para manualidades y chacinerías.  
 FR File de coton en pelote. Indiqué pour des travaux manuels.  
 EN Cotton thread wound into a ball. Suitable for handicraft and pork butcher's.  
 IT Filo di cotone, indicato per lavori manuali e prodotti alimentari.  
 PT Fio de algodão em novelo. Indicado para artesanato e charcutaria.

Ref	Ø	↔	♻️	⚖️	📦	📦	📦	📦
0810 1056	1 mm	125 mm	☐	50 g	1	10	2,39	✓

MADEJA DE ESTOPA (CÁÑAMO) / FIL D'EMBALLAGE EN CHANVRE / TOW SKEIN / STOPPA DI CANAPA SPECIALE / MEADA DE ESTOPA (CÂNHAMO)



ES Madeja de estopa cáñamo especial. Indicado para fontanería y riegos.  
 FR Fil d'emballage chanvre spécial. Indiqué pour la plomberie et les irrigations.  
 EN Cotton thread wound into a ball. Suitable for handicraft and plumbers.  
 IT Stoppa di canapa speciale. Indicata per l'idraulica e l'irrigazione.  
 PT Meada de estopa cânhamo especial. Indicado para canalização e irrigação.

Ref	♻️	⚖️	📦	📦	📦	📦
0810 1074	NATURAL	20 g	1	10	2,35	✓
0810 1075	NATURAL	50 g	1	10	3,53	✓
0810 1076	NATURAL	200 g	1	50	4,66	✓

CINTA CÁÑAMO / FIL PLOMBIER / PLUMBERS HEMP / NASTRO CANAPA / FITA DE ESTOPA PARA CANALIZAÇÃO



Ref	♻️	⚖️	📦	📦	📦
0810 1087	NATURAL	50 g	1	25	5,64
0810 1088	NATURAL	100 g	1	16	8,52

HILO DE SEDAL MONOFILAMENTO DE NYLON 100% / FIL MONOFILAMENTDE NYLON 100% / FISHING MONO-THREAD 100% NYLON LINE  
 FILO LENZA IN NYLON 100% / FIO DE SEDELA MONOFILAMENTO 100% NYLON



ES En bobinas y carretes. Óptimo para pesca, escaparates, decoración, plumadas, construcción, etc.  
 FR Fuseaux et bobines. Idéal pour les vitrines, la décoration, fils à plomb, construction, ect.  
 EN Bobbins and reels. Suitable for fishing, showcases, decoration, plumbs, bricks, building, etc.  
 IT Per mandrini e bobine. Ideale per pesca, vetrine, decorazioni, costruzioni, ecc.  
 PT Em carretéis e bobinas. Ideal para a pesca, vitrines, decoração, prumadas, construção, etc.

Ref	Ø	♻️	↔	📦	📦	📦	📦
0810 1084	0.90 mm	☐	100 m	1	6	9,60	✓
0810 1085	0.90 mm	■	100 m	1	6	9,60	✓
0810 1086	0.90 mm	■	100 m	1	6	9,60	✓
0810 1160	0.90 mm	■	100 m	1	6	9,60	✓





PULPOS ELÁSTICOS REDONDOS / ÉLASTIQUES PLATS / ROUNDED ELASTIC STRAPS / CORDE ELASTICHE ROTONDE / CORDA ELÁSTICA ARREDONDADA



ES Pulpo CE 10 especial alta elasticidad. Interior en látex hidratado con silicona para impermeabilizar. Hilo de poliéster en su exterior. Utilizar únicamente como sujeción, nunca como fijación.

FR Élastique CE 10 spécial grande élasticité. Intérieur en latex imbibé avec silicone pour imperméabiliser. Fil de polyester à l'extérieur. Utiliser uniquement comme attache, jamais comme fixation.

EN CE 10 is a special strap with high elasticity. Interior is made from silicon latex to make it waterproof. Exterior is made from polyester thread. Use it to fasten, never to fix.

IT Corda elastica CE 10 speciale, alta elasticità. Internamente latex idratato con del silicone per renderlo impermeabile. Poliestere all'esterno. Utilizzare unicamente come attacco, non come fissaggio.

PT Gancho CE 10 especial alta elasticidade. Interior em látex hidratado com silicone para impermeabilizar. Fio de poliéster no seu exterior. Usá-lo apenas para prender, nunca para fixar.

Ref	∅	🌀	↔	📦	📊	📄
<b>0810 1080</b>	10 mm	SURTIDO	1,25 m	1	<b>7,74</b>	✓

PULPOS ELÁSTICOS REDONDOS / ÉLASTIQUES PLATS / ROUNDED ELASTIC STRAPS / CORDE ELASTICHE ROTONDE / CORDA ELÁSTICA ARREDONDADA



ES Pulpo CE 10 especial alta elasticidad. Interior en látex hidratado con silicona para impermeabilizar. Hilo de poliéster en su exterior. Utilizar únicamente como sujeción, nunca como fijación.

FR Élastique CE 10 spécial grande élasticité. Intérieur en latex imbibé avec silicone pour imperméabiliser. Fil de polyester à l'extérieur. Utiliser uniquement comme attache, jamais comme fixation.

EN CE 10 is a special strap with high elasticity. Interior is made from silicon latex to make it waterproof. Exterior is made from polyester thread. Use it to fasten, never to fix.

IT Corda elastica CE 10 speciale, alta elasticità. Internamente latex idratato con del silicone per renderlo impermeabile. Poliestere all'esterno. Utilizzare unicamente come attacco, non come fissaggio.

PT CE 10 é uma corda especial com elasticidade elevada, interior é feito de látex com silicone à prova de água. Exterior é feito de fio de poliéster. Use-a para prender, nunca para fixar.

Ref	∅	🌀	↔	📦	📊	📄
<b>0810 1235</b>	6 mm	SURTIDO	0,75 m	1	<b>3,62</b>	✓
<b>0810 1089</b>	8 mm	SURTIDO	1 m	1	<b>5,02</b>	✓

PULPOS ELÁSTICOS PLANOS / ÉLASTIQUES PLATS / FLAT ELASTIC STRAPS / CORDE ELASTICHE PIATTE / GANCHOS ELÁSTICOS PLANOS

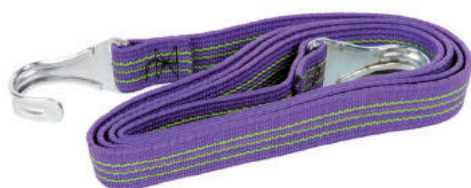

Ref	↔	↑↓	📦	📦	📊	📄
<b>0810 1103</b>	0,75 m	18 mm	1	10	<b>5,46</b>	✓
<b>0810 1081</b>	1 m	18 mm	1	1	<b>5,84</b>	✓
<b>0810 1082</b>	1,5 m	18 mm	1	1	<b>7,21</b>	✓
<b>0810 1083</b>	2 m	18 mm	1	1	<b>7,96</b>	✓

GANCHO PULPO PARA CUERDA ELAST. / CROCHET / HOOK / GANCIO A POLIPO PER CORDA ELAST. / GANCHO ESTICADOR PARA CORDA ELAST.



Ref	∅	📦	📊
<b>0810 1100</b>	6 mm	1	<b>0,73</b>
<b>0810 1098</b>	8 mm	1	<b>0,94</b>
<b>0810 1099</b>	10 mm	1	<b>1,20</b>



MALLA MOSQUITERA ALUMINIO 16X16 / GRILLAGE MOUSTIQUAIRE ALUMINIUM 16X16 / ALUMINIUM ALLOY WIRE NETTING 16X16  
 ZANZARIERA IN ALLUMINIO 16X16 / MALHA MOSQUITEIRA ALUMÍNIO 16X16



Ref	↔	المساحة	📦	📊
1060 1001	0,8 x 25 m	16 x 16	2	72,54
1060 1002	1,0 x 25 m	16 x 16	2	86,82
1060 1003	1,2 x 25 m	16 x 16	2	109,04

ENREJADO TRIPLE TORSIÓN / GRILLAGE TRIPLE TORSION / GALVANISED HEXAGONAL WIRE NETTING  
 RETE TRIPLA TORSIONE / ESTRUTURA TRIPLA TORSÃO

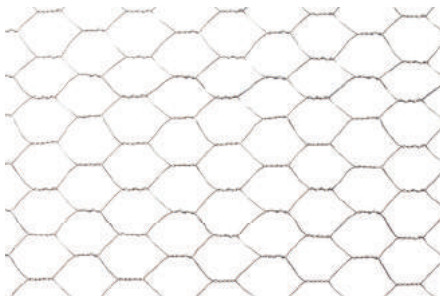

Ref	⬆	∅	↔	📦	📊
1060 1011	13 mm	0,7 mm	1 x 5 m	1	17,47
1060 1012	13 mm	0,7 mm	1 x 50 m	1	145,90
1060 1013	25 mm	0,8 mm	1 x 5 m	1	15,22
1060 1014	25 mm	0,8 mm	1 x 50 m	1	99,95
1060 1015	51 mm	0,9 mm	1 x 5 m	1	8,85
1060 1016	51 mm	0,9 mm	1 x 50 m	1	62,06
1060 1017	51 mm	0,9 mm	1,5 x 50 m	1	89,86

ROLLO ALAMBRE GALVANIZADO / ROULEAU FIL GALVANISÉ / HOT-DIPPED GALVANISED WIRE  
 ROTOLO FILO ZINCATO / ROLO ARAME GALVANIZADO



1 KG

Ref	📊	✍	↔ APROX	∅	📊	📦	📊
1060 1021	1 kg	Nº 6	135 m	1,1 mm	1	20	6,76
1060 1022	1 kg	Nº 8	96 m	1,3 mm	1	20	6,76
1060 1023	1 kg	Nº 10	72 m	1,5 mm	1	20	6,76
1060 1024	1 kg	Nº 12	50 m	1,8 mm	1	20	6,76
1060 1025	1 kg	Nº 14	33 m	2,2 mm	1	20	6,14
1060 1026	1 kg	Nº 16	22 m	2,7 mm	1	20	6,14



5 KG

Ref	📊	✍	↔ APROX	∅	📊	📦	📊
1060 1051	5 kg	Nº 6	675 m	1,1 mm	1	20	33,18
1060 1052	5 kg	Nº 8	480 m	1,3 mm	1	20	33,18
1060 1053	5 kg	Nº 10	360 m	1,5 mm	1	20	33,18
1060 1054	5 kg	Nº 12	250 m	1,8 mm	1	20	33,18
1060 1055	5 kg	Nº 14	165 m	2,2 mm	1	20	29,33
1060 1056	5 kg	Nº 16	110 m	2,7 mm	1	20	29,33

MALLA ELECTROSOLDADA GALVANIZADA / GRILLAGE ELECTROSOUDE GALV. / HOT-DIPPED GALVANISED WELDED WIRE MESH  
 RETE ELETTRISALDATA ZINCATA / MALHA ELETRO-SOLDADA GALV.

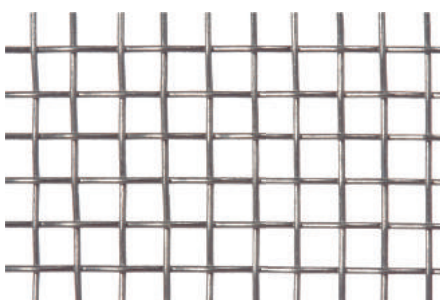

Ref	⬆	∅	↔	📦	📊
1060 1031	6 x 6 mm	0,8 mm	1 x 25 m	1	213,62
1060 1032	13 x 13 mm	0,9 mm	0,6 x 25 m	1	73,38
1060 1033	13 x 13 mm	0,9 mm	0,8 x 25 m	1	95,38
1060 1034	13 x 13 mm	0,9 mm	1 x 25 m	1	116,81
1060 1035	19 x 19 mm	1,4 mm	1 x 25 m	1	176,28
1060 1036	25 x 25 mm	2,0 mm	1 x 25 m	1	240,42





ALAMBRE DE ESPINO GALVANIZADO / FIL BARBELE GALVANISÉ / GALVANISED BARBED WIRE  
 FILO SPINATO ZINCATO / ARAME FARPADO GALVANIZADO

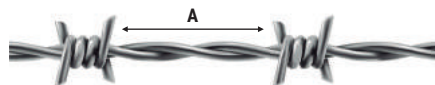

Ref	Ø	A	↔	📦	📊
<b>1060 1041</b>	1,7 mm	12 cm	50 m	1	<b>16,90</b>



	ES	FR	EN	IT	PT
<b>Ref</b>	Referencia	Référence	Reference	Riferimento	Referência
<b>M</b>	Métrica	Métrique	Metrical	Metrica	Métrica
	Diámetro	Diamètre	Diameter	Diametro	Diâmetro
	Packing	Conditionnement	Packing	Imballo	Embalagem
	Precio	Prix	Price	Prezzo	Preço
	Peso	Poids	Weight	Peso	Peso
	Roldana	Poulie	Sheave	Puleggia	Roldana
	Descripción	Description	Description	Descrizione	Descrição
	Unidad mínima de venta	Nombre d'unités minimum de vente	Minimum sale unit	Quantitativo minimo di vendita	Unidade mínima de venda
	Longitud	Longueur	Length	Lunghezza	Comprimento
	2 ramales 0-45°	2 branches	2 branches line	2 bracci	2 ramais
	3/4 ramales 0-45°	3/4 branches	3/4 branches line	3/4 bracci	3/4 ramais
	Tiro directo	Tir direct	Direct pull	Tiro diretto	Linga de corrente simples
	Ahorcado	Pendu	Hanger	Cappio	Linga de corrente tipo forca
	2 ramales 45-60°	2 branches 45-60°	2 branches line 45-60°	2 bracci 45-60°	2 ramais 45-60°
	3/4 ramales 45-60°	3/4 branches 45-60°	3/4 branches line 45-60°	3/4 bracci 45-60°	3/4 ramais 45-60°
	Carga máxima	Charge maximum	Maximum load	Carico massimo	Carga máxima
<b>MODEL</b>	Modelo	Modèle	Model	Modello	Modelo
	Rosca	Filetage	Thread	Rivettatura	Rosca entrada de ar PT
	Diámetro Cable	Diamètre Câble	Chain Diameter	Diametro Cavo	Diâmetro do cab
	Diámetro Alambre	Diamètre Fil	Wire Diameter	Diametro Filo	Diâmetro fio
	Carga de Rotura	Charge de Rupture	Break Load	Carico di Rottura	Carga de ruptura
	Grosor	Grosueur	Thickness	Spessore	Espessura
	Colores	Couleur	Color	Colore	Cores
	Blíster	Blister	Blister	Blister	Blister
	Diámetro Roldana	Diamètre poulie	Sheave diameter	Diametro puleggia	Diâmetro roldana
	1 ramal 0°	1 branches 0°	1 branches 0°	1 bracci 0°	1 ramais 0°
	1 ramal 90°	1 branches 90°	1 branches 90°	1 bracci 90°	1 ramais 90°
	2 ramales 0°	2 branches 0°	2 branches 0°	2 bracci 0°	2 ramais 0°
	2 ramales 90°	2 branches 90°	2 branches 90°	2 bracci 90°	2 ramais 90°
	Ancho cinta	Ruban large	Tape width	Larghezza nastro	Largura da fita
	Alto malla	Maille haute	Netting height	Altezza maglia	Altura malha
	Galga	Jauge	Gauge	Spessimetri	Calibrador





●.cofan

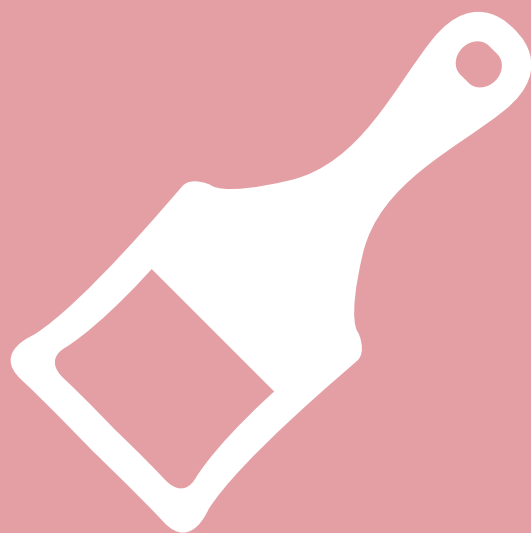





# ÍNDICE / INDEX / CONTENTS

## INDICE / ÍNDICE



**620**

ADHESIVO / COLLE / ADHESIVE  
ADESIVO / ADESIVO



**648**

BARNIZ / VERNIS / VARNISH  
VERNICE / VERNIZ



**627**

PRODUCTOS QUÍMICOS / PRODUITS CHIMIQUES  
CHEMICALS / PRODOTTI CHIMICI / QUÍMICOS



**649**

QUÍMICOS Y ACEITES / PRODUITS CHIMIQUES ET D'HUILES  
CHEMICALS AND OILS / PRODOTTI CHIMICI E OLIO  
QUÍMICOS E ÓLEOS



**639**

PINTURA EN SPRAY / LAQUE ACRYLIQUE SPRAY  
ACRYLIC SPRAY PAINT / VERNICE ACRILICA  
PINTURA EM SPRAY



**650**

QUITAPINTURAS, DISOLVENTE Y SELLADORA  
DECAPANT PEINTURES, DISSOLVANT E SCELLEMENT  
PAINT REMOVER, DISSOLVENT AND SEALANT  
SVERNICIATORE, SOLVENTE E SIGILLANTE  
REMOVEDOR DE PINTURA, DISSOLVENTE E SELANTE



**644**

ESMALTES SINTÉTICOS / ÉMAIL SYNTHÉTIQUE  
SYNTHETIC ENAMEL / SMALTO SINTETICO  
ESMALTE SINTÉTICO



**651**

PINTURA PLÁSTICA / PEINTURE PLASTIQUE  
PLASTIC PAINTING / PITTURA PLASTICA  
PINTURA PLÁSTICA



**647**

ESMALTE ANTIOXIDANTE / PEINTURE ANTIOXYDANTE  
RUST-PROOF ENAMEL / SMALTO ANTIOSSIDANTE  
ESMALTE ANTIOXIDANTE



**653**

IMPERMEABILIZANTE / WATERPROOFING  
IMPERMÉABLE / IMPERMEABILIZZANTE  
IMPERMEABILIZANTE



**653**

PINTURA PISCINAS / PEINTURE PISCINE  
PAINT FOR SWIMMING POOLS / ACQUA PER PISCINE  
PINTURA PISCINAS

---



**654**

ACCESORIOS DE PINTURA / ACCESSOIRES DE PEINTURE  
PAINT ACCESSORIES / ACCESSORI DA PITTURA  
ACESSÓRIOS DE PINTURA

---



**666**

EMBALAJE / EMBALLAGE / WRAPPING  
PAGLIOLO / EMBALAGEM

---



**673**

CINTA ADHESIVA / RUBAN ADHESIF  
ADHESIVE TAPES / NASTRO ADESIVO / FITA ADESIVA

---

**i**

**678**

GLOSARIO / GLASSAIRE / GLOSSARY  
GLOSSARIO / GLOSSÁRIO



SILICONA ACÉTICA UNIVERSAL 280 ml / SILICONE ACÉTIQUE UNIVERSELLE 280 ml / UNIVERSAL ACETIC SILICONE 280 ml  
SILICONE ACETICO UNIVERSALE 280 ml / SILICONE ACÉTICO UNIVERSAL 280 ml



ES Sellante de silicona monocomponente de reticulación acética que en contacto con la humedad atmosférica se convierte en una junta elástica. Sellado de todo tipo de juntas de estanqueidad, en materiales como vidrio, cerámica y materiales vitrificados, aluminio anodizado o fibra de vidrio/poliéster. CARACTERÍSTICAS: Curado rápido, excelente adhesión sobre una gran variedad de soportes no porosos, elasticidad permanente, para interiores y exteriores, gran resistencia a la radiación UV, los cambios de temperatura y al envejecimiento. Con protección fungicida. Adecuado para aplicaciones sanitarias domésticas. Las juntas realizadas no pueden ser pintadas.

FR Silicone monocomposant acétique d'un contact avec l'humidité atmosphérique se convertit en joint élastique. Sers de tout type de joint d'étanchéité pour les matériaux comme le verre, la céramique et des matériaux vitrifié, l'aluminium anodisé ou fibre en verre / polyester. CARACTÉRISTIQUES: Durcissement rapide, une adhésion excellente sur une grande variété de supports non poreux, élasticité permanente, pour intérieurs et extérieurs, grande résistance à la radiation UV, aux changements de température et au vieillissement. Avec une protection fongicide. Approprié aux applications sanitaires domestiques. Les joints réalisées ne peuvent pas être peintes.

EN One-component acetic reticulation silicone sealant which, in contact with atmospheric moisture, becomes an elastic joint. Seals all kinds of joints, in materials such as glass, ceramic and vitrified materials, anodised aluminium or glass/polyester fiberglass. FEATURES: Short curing time, excellent adhesion to various non-porous surfaces, permanently elastic, for interiors and exteriors, high resistance to UV radiation, temperature changes and ageing. With fungicide protection. Suitable for domestic sanitary use. Made joints should not be painted.

IT Sigillante di silicone monocomponente di reticolazione acetica che in contatto con l'umidità atmosferica si converte in un giunto elastico. Sigillante per tutti i tipi di guarnizioni, materiali vetrosi, ceramici e vetrificati, alluminio anodizzato o vetroresina/poliestere. CARATTERISTICHE: Trattamento veloce, ottima adesione su una vasta gamma di supporti non porosi, elasticità permanente, per interni ed esterni. Alta resistenza alla radiazione UV, ai cambi di temperatura ed all'invecchiamento. Protezione fungicida. Adatto per applicazioni sanitarie domestiche. Le giunture effettuate non possono essere verniciate.

PT Selante de silicone de componente único de reticulação acética que em contato com a humidade atmosférica torna-se em uma junta elástica. Selante para todo o tipo de vedação de juntas em materiais tais como vidro, materiais cerâmicos e vitrificados, alumínio anodizado ou fibra de vidro / poliéster. CARACTERÍSTICAS: de cura rápida, excelente aderência sobre uma ampla variedade de suportes não-porosos, permanentemente elásticos, para interiores e exteriores, resistência elevada à radiação UV, mudanças de temperatura e ao envelhecimento. Protecção fungicida. Adequado para aplicações sanitárias em casa. As juntas realizadas não podem ser pintadas.



Ref					
1550 0531BL		280 ml	1	12	4,14
1550 0531GR		280 ml	1	12	4,14
1550 0531NE		280 ml	1	12	4,14
1550 0531TR	Transparente	280 ml	1	12	4,14

SILICONA NEUTRA 300 ml / SILICONE NEUTRE 300 ml / NEUTRAL SILICONE 300 ml / SILICONE NEUTRO 300 ml / SILICONE NEUTRO 300 ml



ES Silicona neutra o sellante de silicona de sistema neutro. Está especialmente recomendado para el sellado entre carpintería y obra, juntas de dilatación, juntas en construcciones de paneles prefabricados, juntas entre paredes y pavimentos, aplicaciones en contacto con vidrios tratados y todas aquellas aplicaciones que necesiten un sellante inodoro.

FR Silicone neutre ou Produit d'étanchéité de silice de système neutre. Spécialement recommandée pour le collage de menuiserie et travaux divers, joints de dilatation, construction de panneaux préfabriqués, collage entre murs et pavés, applications en contact du verre traité et toutes ces applications qui ont besoin d'un produit d'étanchéité inodore.

EN Neutral silicone or neutral system silicone seal. It's especially recommended for sealing carpentry items to construction works, for expansion joints, joints of prefabricated panels, joints between walls and flooring, treated glass and all applications that need an odorless seal.

IT Silicone neutro o sigillante di silicone neutro. Particolarmente indicato per la sigillatura nella carpenteria e nel settore edile. Indicato per giunti di dilatazione, giunti per pannelli prefabbricati, su pareti e pavimenti, applicazioni in contatto con vetro trattato e tutti quelle applicazioni che necessitano di un sigillante inodore.

PT Silicone neutro ou o selante de silicone neutro. É especialmente recomendado para selar itens de carpintaria, para obras de construção, para juntas de dilatação, juntas de painéis pré-fabricados, juntas entre paredes e pisos, vidro tratado e todas as aplicações que necessitam de um selante inodoro.



Ref					
1550 0631BL		300 ml	1	12	6,76
1550 0631TR	Transparente	300 ml	1	12	6,76

SILICONA ÁCIDA SANITARIA / SILICONE ACIDE SANITAIRE / SANITARY ACID SILICONE / SILICONICHE ACIDA SANITARIA / SILICONE ACIDO SANITÁRIO  
300 ml



ES Indicada para baños y cocinas. Su fórmula tratada con protección al moho garantiza una alta resistencia a la humedad, asegurando juntas higiénicas y limpias. Tiempo de secado 24 horas.

FR Convient pour les salles de bains et les cuisines. Sa formule traitée avec protection contre les moisissures garantit une résistance élevée à l'humidité, assurant des joints hygiéniques et propres. Temps de séchage 24 heures.

EN Intended for kitchens & baths. Its formula, treated with a protection against mold, ensures a high moisture resistance, providing hygienic and clean joints. Drying time on 24 hours.

IT Indicato per bagni e cucine. La sua formula, tratta con una protezione contro la muffa, garantisce un'alta resistenza all'umidità, fornendo giunture igieniche e pulite. Durata d'essiccazione in 24 ore.

PT Indicada para cozinhas e WC. Formulada com protecção anti-mofo garante uma alta resistência à humidade, assegurando juntas higiénicas e limpas. Tempo de secagem 24 horas.

ES **Especial baños y cocinas (Anti-moho).**

FR **Salles de bains et cuisines spéciales (anti-moisissures).**

EN **Special for bathrooms & kitchens (mildewstat).**

IT **Speciale per bagni e cucine (antimuffa).**

PT **Especial WC e cozinhas (anti-mofo).**

Ref					
1550 0541BL		300 ml	1	12	5,40



MASILLA SELLADORA ACRÍLICA 300 ml / MASTIC DE FIXATION 300ml / SEALANT PUTTY 300 ml  
 MASTICE DI FISSAGGIO 300 ml / MASSA SELANTE 300 ml

CE



ES Masilla monocomponente en base acuosa, de secado rápido, apta para el sellado de juntas de relleno y acabado. Esta masilla acrílica una vez seca permanece flexible y puede pintarse. Ideal para sellado de juntas interiores, juntas de construcción, reparaciones de paredes y techos, sellados de carpintería, relleno de grietas y pegado de placas de poliestireno.

FR Mastic mono composant, base aqueuse, séchage rapide, conçu pour remplissage et finitions. Ce mastic acrylique une fois sec reste flexible et peut être peint. Idéal pour les ensemble d'intérieurs, matériaux de construction, réparations de murs et plafonds, menuiserie, remplissage de fissures et collage de plaques de polystyrène.

EN Monocomponent water-based sealant, quick drying, suitable for sealing joints and for filling. Once dry, this acrylic sealant remains flexible and can be painted. Ideal for sealing interior joints, construction joints, repairing of walls and ceilings, carpentry sealing, filling of cracks and gluing Polystyrene boards.

IT Mastice monocomponente a base acquosa, a rapida essiccazione, indicato per la sigillatura di giunti di riempimento e finiture. Questo mastice acrilico una volta completamente asciutto rimane flessibile e può essere verniciato. Ideale per sigillare giunti in edilizia, riparazione di pareti e tetti, riempire le fessure, operazioni di carpenteria ed incollaggio di lastre di polistirene.

PT Massa monocomponente à base de água, secagem rápida, adequado para selagem de juntas de enchimento e acabamento. Depois de seco, este Selante acrílico permanece flexível e pode ser pintado. Ideal para vedação de juntas interiores, juntas de construção, reparação de paredes e tectos, vedação em carpintaria, enchimento de fissuras e colagem de placas de poliestireno.



Ref					
1550 0231BL		300 ml	1	12	2,76
1550 0231GR		300 ml	1	12	2,76

POLÍMERO SELLADOR "MS" 290 ml / FIXATION POLYMÈRE 290 ml / POLYMER SEALANT 290 ml  
 POLIMERO FISSANTE 290 ml / POLÍMERO SELANTE 290 ml

CE



ES Polímero Sellador "MS" híbrido a base de silano modificado (Modified Silane - MS). Es un sellante elástico monocomponente, de curado rápido, basado en una innovadora tecnología de polímeros híbridos, para aplicaciones en interior y exterior. Elevada elasticidad y capacidad de movimiento (±25%). Sellados en general en construcción, incluso sobre superficies húmedas. Sellados de prefabricados de hormigón. Juntas de dilatación y conexión en fachadas, por ejemplo, juntas entre marcos de ventanas y puertas a obra, escalones, balcones, etc.

FR Colle polymère MS "hybride sur base silane modifié (Modified Silane - MS). C'est un produit d'étanchéité élastique mono composant, traitement rapide, basé une technologie novatrice de polymères hybrides pour des applications en intérieur et en extérieur. Importante élasticité et capacité de mouvement (±25%). Collage en général dans le domaine de la construction, même sur des surfaces humides. Collage sur préfabrications de béton. Spécial dilatation et connexion sur façades, par exemple, encadrements de fenêtres et de portes, escaliers, balcons, etc..

EN Hybrid Polymer sealant "MS", based on Modified Silane - MS. It is one-component elastic sealant of quick drying, based on an innovative technology of hybrid polymers, for interior and exterior applications. High elasticity and movement capability (±25%). Generally used in construction, even for wet surfaces. Sealing of prefabricated concrete. Expansion and connection joints in facades, for example, joints between window/door frames and construction, stairs, balconies, etc.

IT Polimero adesivo "MS" ibrido a base di silano modificato (Modified Silane - MS). È un sigillante elastico monocomponente, ad indurimento rapido, basato su una innovativa tecnologia di polimeri ibridi, per applicazioni sia in interni che esterni. Elevata elasticità e capacità di movimento (±25%). Sigillante per edilizia, anche su superfici umide. Sigillante per prefabbricati in calcestruzzo, giunti di dilatazione e connessioni varie, come ad esempio infissi di finestre e porte, scale, balconi, ecc.

PT Polímero Selante "MS" híbrido, com base em silano modificado (Modified Silane - MS). É um Selante elástico de componente único, de secagem rápida, com base numa tecnologia inovadora de polímeros híbridos, para aplicações em interiores e exteriores. Alta elasticidade e capacidade de movimento (± 25%). Geralmente usado na construção, mesmo para superfícies molhadas. Selagem de prefabricados em betão. Juntas de dilatação e ligação em fachadas, por exemplo, articulações entre os quadros da janela e portas, para construção, escadas, varandas, etc.



Ref					
1550 0431BL		290 ml	1	12	9,54
1550 0431GR		290 ml	1	12	9,54



MASILLA POLIURETANO 300 ml / MASTIC POLYURÉTHANE 300 ml / POLYURETHANE PUTTY 300 ml  
 MASTICE POLIURETANICO 300 ml / MASSA POLIURETANO 300 ml

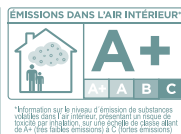

ES Sellante de poliuretano de todo tipo de juntas y grietas, además de pegado elástico multiusos en cualquier tipo de superficies. Alta adherencia en todo tipo de soportes, impermeable, elástica y resistente a vibraciones y golpes. Es posible pintar una vez seca. Ideal para el sellado y estanquidad de juntas entre materiales de construcción, juntas de dilatación horizontales, tejas, fibrocemento, paneles, tabiques, etc.

FR Produit d'étanchéité en polyuréthane pour tout type de collage de matériaux et fissure, collage élastique multi-usages sur tout type de surfaces. Forte adhérence sur tous les supports, imperméable, élastique et résistante aux vibrations et aux coups. Possibilité de peindre une fois sec. Idéal pour le collage et l'étanchéité des matériaux de construction, des ensembles à dilatation horizontale, les tuiles, le fibrociment, les panneaux, les cloisons etc..

EN Polyurethane sealant for all kinds of joints and cracks as well as to stuck any type of multipurpose elastic surfaces. High adhesion for all types of brackets - impermeable, elastic and resistant to vibration and blows. It is possible to paint once dry. Ideal for sealing joints of building materials, horizontal expansion joints, tiles, cement boards, panels, partition walls, etc.

IT Sigillante poliuretano per tutti i tipi di giunti e fessure, adatto anche per l'incollaggio elastico di qualsiasi tipo di superficie. Alta aderenza su tutti i tipi di supporti, impermeabile, elastico e resistente alle vibrazioni ed ai colpi. È possibile verniciare una volta asciutto. Ideale per sigillare giunti tra i materiali di edilizia, giunti di dilatazione orizzontali, tegole, fibrocemento, pannelli, pareti divisorie, ecc.

PT Selante de poliuretano para todos os tipos de juntas e fissuras, bem como a colagem elástica multiusos em qualquer tipo de superfícies. Alta aderência para todos os tipos de suportes - impermeável, elástica e resistente a vibrações e golpes. É possível pintar uma vez seco. Ideal para vedação de juntas de materiais de construção, juntas de dilatação horizontais, telhas, placas de cimento, painéis, divisórias, etc.

Ref					
<b>1550 0331BL</b>		300 ml	1	12	<b>7,00</b>
<b>1550 0331GR</b>		300 ml	1	12	<b>7,00</b>

ESPUMA POLIURETANO 750 ML 45 L MANUAL / MOUSSE MANUEL POLYURÉTHANE 750 ML 45 L / POLYURETHANE FOAM 750 ML 45 L MANUAL  
 SCHIUMA POLIURETANO 750 ML 45 L MANUALE / ESPUMA POLIURETANO 750 ML 45 L MANUAL

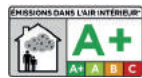

750 ml



ES Espuma de poliuretano expansible 45 L de aplicación manual (Cánula). APLICACIONES: Se utiliza para aislar, sellar o fijar marcos de ventanas o puertas, llenar huecos de diversas cavidades, tubos y conductos de aire, paneles de aislamiento, etc.

FR Une mousse de polyuréthane expansible 45 l d'application manuelle. APPLICATIONS: On l'utilise pour isoler, sceller ou fixer des cadres de fenêtres ou des portes, remplir des creux divers, des cavités, des tubes et des conduits d'air, des panneaux d'isolement, etc.

EN Expandable polyurethane foam 45 l for manual application (cannula). APPLICATION: It is used to isolate, seal or fix window and door frames, to fill gaps, pipes and air ducts, insulation boards, etc.

IT Schiuma in poliuretano espanso 45 l di applicazione manuale (cannula). APPLICAZIONI: Si utilizza per isolare, sigillare o fissare serramenti per porte e finestre, riempire fori di diverse cavità, tubi e condotti d'aria, pannelli isolanti, ecc.

PT Espuma de poliuretano expansível 45 l de aplicação manual (cânula). APLICAÇÕES: É usado para isolar, selar ou fixar quadros de portas e janelas, enchendo buracos de diversas cavidades, tubos e dutos de ar, painéis de isolamento, etc.

ES	Capacidad expansión / Expansion capability	<b>Máx 30%</b>
EN	Formación de piel / Skin forming time	<b>30-40 min</b>
	Secado al tacto / Dry to touch time	<b>10-14 min</b>
	Resistencia rotura / Tensile strenght	<b>10 N/cm<sup>2</sup></b>
	Resistencia a compresión (DIN 53421) / Compression strenght (DIN 53421)	<b>1,5 N/cm<sup>2</sup></b>

Ref				
<b>1550 0101</b>	750 ml	1	12	<b>8,56</b>

ESPUMA POLIURETANO A PISTOLA / MOUSSE EN POLYURÉTHANE POUR PISTOLET / POLYURETHANE GUN FOAM  
 SCHIUMA DI POLIURETANO PER PISTOLA / ESPUMA DE POLIURETANO À PISTOLA

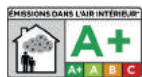

750 ml



ES Espuma elástica de baja expansión. Aislamiento acústico y térmico. Adhesión multisupoorte.

FR Mousse élastique à faible expansion. Isolation acoustique et thermique. Adhésion multi-supports.

EN Low expansion flexible foam. Acoustic and thermal insulation. Multi support adherence.

IT Schiuma flessibile a bassa espansione. Isolamento termico ed acustico. Adesione multisupporto.

PT Espuma elástica de baixa expansão. Isolamento acústico e térmico. Adesão multi-supoorte.

ES	Capacidad expansión / Expansion capability	<b>Máx 30%</b>
EN	Formación de piel / Skin forming time	<b>30-40 min</b>
	Secado al tacto / Dry to touch time	<b>10-14 min</b>
	Resistencia rotura / Tensile strenght	<b>10 N/cm<sup>2</sup></b>
	Resistencia a compresión (DIN 53421) / Compression strenght (DIN 53421)	<b>1,5 N/cm<sup>2</sup></b>

Ref				
<b>1550 0110</b>	750 ml	1	12	<b>8,80</b>





LIMPIADOR DE ESPUMA DE POLIURETANO / DÉTERGENT MOUSSE POLYRÉTHANE / POLYURETHANE FOAMING CLEANER  
PULITORE PER SCHIUMA POLYURETHANE / LIMPEZA DE ESPUMA DE POLIURETANO



500 ml



- ES Disuelve perfectamente la espuma no curada y limpia completamente el mecanismo interno y las partes externas de las pistolas dispensadoras. Contiene más agentes activos y menos propelente.
- FR Il dissout parfaitement la mousse non durcie et nettoie complètement le mécanisme interne et les pièces des pistolets distributeurs. Il contient plus d'agents actifs et moins d'agent de propulsion.
- EN Dissolves the foam non-cured perfectly and completely cleans the internal mechanism of dispenser guns and their parts. It contains more active agents and less propellants.
- IT Questo prodotto rimuove perfettamente la schiuma non indurita e pulisce completamente il meccanismo interno e le suoi parti delle pistole. Contiene più sostanze tensioattive e meno propellente.
- PT Dissolve perfeitamente a espuma não curada e limpa completamente o mecanismo interno e as partes das pistolas de distribuição. Contém mais agentes ativos e menos propulsor.

Libre de CFC'S / Sans CFC / Free CFC emissions / Emissioni zero di CFC / Livre de CFC

Ref				
1500 0112	500 ml	1	12	7,99

PISTOLA ESPUMA POLIURETANO ULTRA / PISTOLET À MOUSSE POLYURETHANE ULTRA / POLYURETHANE FOAM GUN ULTRA  
PISTOLA PER SCHIUMA DI POLIURETANO ULTRA / PISTOLA ESPUMA DE POLIURETANO ULTRA



- ES Pistola para uso profesional en construcción, montaje, aislamiento y acabado. Punta de pistola de latón. Cuerpo de metal y mecanismo de gatillo de acero regulable.
- FR Pistolet à usage professionnel pour la construction, le montage, l'isolation et la finition. Pointe du pistolet en laiton. Corps en métal et mécanisme de détente réglable en acier.
- EN Foam gun intended for professional use in construction, assembly, insulation and finished. Brass control nozzle. It has a metallic body & an adjustable mechanism of the steel trigger.
- IT Pistola destinata ad un uso professionale nella edilizia, assemblaggio, isolamento e rifinitura. Otturatore in ottone Corpo metallico e grilletto in acciaio regolabile.
- PT Pisola para uso profissional em construção, montagens, isolamento e acabamento. Ponta da pisola em latão. Corpo em metal e mecanismo do gatilho de aço regulável.

Ref					
1550 0111	2 mm	18 cm	1	20	21,12

PISTOLA DE INYECTAR SILICONA / PISTOLET POUR SILICONE / GUN FOR SILICONE INJECTION  
PISTOLA PER SILICONARE / PISTOLA DE INJETAR SILICONE



- ES Diseño ergonómico, facilita un uso confortable todo el día. Acción de gatillo con un 100% más de duración. Para usos constantes con selladores muy densos. Componentes móviles endurecidos.
- FR Design ergonomique, permet une utilisation confortable toute la journée. Déclencheur solide, durée 100%. Utilisations constantes, fixation très dense. Composants mobiles robustes.
- EN Ergonomic design, provides a comfortable use along the day. Trigger action with an extra 100% duration. For constant uses with thick sealants. Hardened mobile components.
- IT Disegno ergonomico, permette un uso confortevole anche in caso di utilizzi prolungati. Corsa attiva del grilletto prolungata del 100%. Per usi continuativi con isolanti molto densi. Componenti mobili rinforzati.
- PT Desenho ergonómico, permite um uso confortável todo o dia. Ação do disparador com 100% mais de duração. Para uso constante com vedandes muito densos. Componentes móveis endurecidos.

Ref			
3100 1020	1	12	14,30

PISTOLA PROFESIONAL PARA RESINA / PISTOLET PROFESSIONNEL POUR RÉSINE / PROFESSIONAL RESIN INJECTION  
PISTOLA PROFESSIONALE PER RESINA / PISTOLA PROFESSIONAL PARA RESINA



- ES Pistola de inyección de resina adhesiva (taco químico) 380 ml de tipo profesional con 3 barras para una fácil aplicación.
- FR Pistolet d'injection de résine adhésive (embout chimie) 380 ml à usage professionnel avec 3 lignes pour une application facile.
- EN Resin injection (chemical fixing-plug). Professional type for 380 ml with 3 rails for easy use.
- IT Pistola per iniezioni di resina adesiva (tassello chimico) 380 ml di tipo professionale con 3 barre per una facile applicazione.
- PT Pistola de injetar resina adesiva (bucha química) 380 ml de tipo profissional com 3 barras para facilitar aplicação.

Ref		
3100 1021	1	21,28



ADHESIVO DE CIANOACRILATO / COLLE CYANOACRYLATE / CYANOACRYLATE ADHESIVE  
ADESIVO CIANOACRILATO / ADESIVO DE CIANOACRILATO



Media viscosidad.  
Fixation moyenne.  
Medium viscosity.  
Media viscosità.  
Viscosidade média.

Ref				
1500 0030	20 g	1	24	3,95
1500 0031	50 g	1	12	7,40

ES ADHESIVO DE CIANOACRILATO - No contiene disolventes, lo que hace que cure más rápidamente. El pegamento endurecido se puede eliminar con calor (200°C). Pega metal, plástico, madera, cristal, etc. Para un pegado aún más rápido usar el activador (ref. 1500 0032).

FR COLLE CYANOACRYLATE - Sans dissolvant, ce qui réduit le temps de durcissement. Le collage sec peut s'éliminer à la chaleur (200°C). Colle le métal, le plastique, le bois, le verre, etc. Pour un collage encore plus rapide, utiliser l'activateur (1500 0032).

EN CYANOACRYLATE ADHESIVE - Solvent free, fast hardening. When hardened, it can be removed by means of heat (200°C). Suitable for metals, plastic, wood, glass, etc...To accelerate cure time can be used an activator (item number 1500 0032).

IT ADESIVO CIANOACRILATO - Non contiene solventi, per una riduzione del tempo di indurimento. I residui induriti si eliminano col calore (200°C). Incolla metallo, plastica, legno, cristallo, etc. Per una presa più rapida utilizzare l'attivatore (1500 0032).

PT ADESIVO CIANOACRILATO - Não contém solventes, por isso endurece mais rápido. Quando endurecido, pode ser removido por meio de calor (200°C). Indicado para metais, plástico, madeira, vidro, etc. Para acelerar o tempo de secagem pode ser usado o ativador (item número 1500 0032).



Alta viscosidad especial para madera.  
Fixation forte special bois.  
High adhesive ideal for wood.  
Alta viscosità specifico per legno.  
Viscosidade alta para madeira.

Ref				
1500 0033	20 g	1	24	3,95
1500 0034	50 g	1	12	7,40

ACTIVADOR DE CIANOACRILATO / ACTIVATEUR CYANOACRYLATE / CYANOACRYLATE ACTIVATOR  
ATTIVATORE CIANOACRILATO / ATIVADOR DE CIANOACRILATO

200 ml



ES Activador de cianoacrilato  
- Spray activador para el pegado de metal, cristal, plástico, etc.  
- Pegado rápido de pequeñas piezas sin esperar.  
- Debe de usarse en la superficie contraria donde se aplique el pegamento.  
- Envase a presión. No respirar los vapores.

FR Activateur de cyanoacrylate  
- Spray activateur pour collage du métal, verre, plastique, etc.  
- Collage rapide de petite pièce sans attente.  
- Doit être utilisé sur la partie opposée à celle où a eu lieu le collage.  
- Emballage sous pression. Ne pas respirer les vapeurs.

EN Cyanoacrylate activator  
- Activator spray suitable for metals, glass, plastics, etc.  
- Quick cure time for small pieces.  
- Apply activator sparingly to one of glued surfaces.  
- Pressurised container. Keep away from sources of ignition.

IT Attivatore cianoacrilato  
- Spray attivatore per il collaggio di metallo, cristallo, plastica, ecc.  
- Incollaggio rapido di piccoli pezzi, senza attesa.  
- Da applicare sulla superficie opposta a quella in cui si applica il collante.  
- Bombola a pressione. Non respirare i vapori.

PT Ativador cianoacrilato  
- Ativador de pulverização adequado para metais, vidro, plásticos, etc.  
- Tempo de secagem rápida para pequenos pedaços.  
- Aplique o ativador com moderação na superfície contrária á cola.  
- Recipiente pressurizado. Não respirar os vapores.

Ref				
1500 0032	200 ml	1	12	8,50

ADHESIVO INSTANTÁNEO BRICOFAN / COLLE INSTANTANÉE / INSTANT GLUE / ADESIVO INSTANTANEO / ADESIVO INSTANTÂNEO



1

2



ES Adhesivo instantáneo multiusos con base de cianoacrilato con 3 y 1 gramo de capacidad. Secado Rápido. Apto para plásticos.  
FR Adhésif polyvalent instantané à base de cyanoacrylate d'une capacité de 3 et 1 gramme. Séchage rapide. Convient aux plastiques.  
EN Multipurpose instant adhesive with a cyanoacrylate base and a capacity of 1 and 3 grams. Quick drying. Suitable for plastics.  
IT Adesivo istantaneo multiuso con una base in cianoacrilato e con una capacità di 1 e 3 grammi. Rapida asciugatura. Adatto per plastiche.  
PT Adesivo instantâneo multiusos com base de cianoacrilato com 3 e 1 grama de capacidade. Secagem rápida. Apto para plásticos.

	Ref		PACK			x pack
1	1500 1160	1 g	4 uds	1	10	2,58
2	1500 1161	3 g	1 uds	1	10	1,25



COLA BLANCA BRICOFAN MADERA / COLLE BLANCHE TRANSPARENTE / TRANSPARENT WHITE ADHESIVE  
COLLA BIANCA TRASPARENTE / COLA BLANCA BRICOFAN MADEIRA



ES Madera y manualidades. Rápida.  
FR Bois et travaux manuels. Rapide.  
EN Wood and DIY. Quick.  
IT Legno e bricolage. Rapido.  
PT Madeira e bricolagem. Rápida.



Ref				
1500 1180	50 g	1	10	2,58

ADHESIVO PARA PVC 250 ML AGUA POTABLE / ADHÉSIF POUR PVC 250 ML EAU POTABLE / ADHESIVE FOR PVC 250 ML DRINKING WATER  
ADESIVO PER PVC 250 ML ACQUA POTABILE / ADESIVO PARA PVC 250 ML ÁGUA POTÁVEL



Con pincel / Avec pinceau / With brush  
Con penello / Com pincel

ES Adhesivo especial para tuberías de PVC rígido y sistemas de presión. Crea uniones resistentes y duraderas, tanto en tubería-tubería, como en tubería-manguito, planchas, perfiles, etc. Su formulación le confiere una excelente estabilidad y longevidad. Tapa provista de pincel aplicador.  
FR Colle spécial pour tubes PVC rigide et des systèmes de pression. Il crée des unions résistantes et durables dans une tuyauterie, manchon, planches, profils, etc... Sa formulation lui attribue une stabilité excellente et une longévité. Un couvercle pourvu d'un pinceau applicateur.  
EN Special adhesive for rigid PVC pipes and pressure systems. To create resistant and long-lasting joints - tube-tube, tube-sleeve, plates, profiles, etc. Its formulation provides excellent stability and long life. Equipped with brush applicator cap.  
IT Adesivo speciale per tubi in PVC rigidi e sistemi sotto pressione. Crea unioni resistenti e durature, sia tubo-tubo che tubomanico, lastre, profili, ecc. La sua formula conferisce un'eccellente stabilità e longevità. Coperchio provvisto di pennello applicatore.  
PT Adesivo especial para tubos de PVC rígido e sistemas de pressão. Cria uniões fortes e duradouras, tanto em tubos-tubos como em tubos-buchas, chapas, perfis, etc. Sua formulação dá excelente estabilidade e longevidade. Tampa fornecida com pincel aplicador.

Ref				
1500 1175	250 ml	1	24	7,75

BOTE ADHESIVO CONTACTO BRICOFAN CON PINCEL (500 ML) / ADHÉSIF DE CONTACT / CONTACT ADHESIVE  
ADESIVO A CONTATTO / ADESIVO CONTATO



ES Multiusos. Con pincel. Apto para pegar plásticos, laminados, madera, contrachapado de madera o para lona. Está diseñado para pegarse a sí mismo.  
FR Multiusage. Avec pinceau. Convient pour coller des plastiques, des stratifiés, du bois, du contreplaqué ou de la toile. Il est conçu pour être collé à lui-même.  
EN Multipurpose. With brush. It helps you bond plastic, laminated articles, wood, plywood or canvas. It is designed to bond itself.  
IT Multiuso. Con penello. Ideale per l'incollaggio di plastica, laminati, legno, compensato in legno o telone. È progettato per l'incollaggio di se stesso.  
PT Multiusos. Com pincel. Apto para colar plásticos, laminados, madeira, contraplacado de madeira ou para lona. Está desenhado para colar-se a si mesmo.

Ref				
1500 1195	500 ml	1	10	9,05

ADHESIVO CONTACTO / COLLE CONTACT / CONTACT ADHESIVE / ADESIVO CONTATTO / ADESIVO CONTACTO



ES Apto para pegar plásticos, laminados, madera, contrachapado de madera o para lona. Está diseñado para pegarse a sí mismo.  
FR Convient pour coller des plastiques, des stratifiés, du bois, du contreplaqué ou de la toile. Il est conçu pour être collé à lui-même.  
EN It helps you bond plastic, laminated articles, wood, plywood or canvas. It is designed to bond itself.  
IT Ideale per l'incollaggio di plastica, laminati, legno, compensato in legno o telone. È progettato per l'incollaggio di se stesso.  
PT Apto para colar plásticos, laminados, madeira, contraplacado de madeira ou para lona. Está desenhado para colar-se a si mesmo.

Ref					
1500 1197	20 ml	1	12	1,27	✓



ADHESIVO PLÁSTICOS RÍGIDOS / ADHÉSIF PLASTIQUES RIGIDES / PLASTIC ADHESIVE STIFF  
ADESIVI PLASTICI RIGIDI / ADESIVO PLÁSTICOS RÍGIDOS



- ES Adhesivo o soldadura química en frío, para plásticos rígidos, agarre inicial rápido que permite pequeñas rectificaciones facilitando el encolado en grandes pegados.
- FR Adhésif ou Soudure chimique à froid, pour plastiques rigides, prise initiale rapide permettant de petites rectifications, en ce qui facilite le collage de grandes surfaces.
- EN Adhesive or cold solvent welding for stiff plastic, initial quick grip that allows small rectifications, making the gluing process easier.
- IT Adesivo o saldatura chimica a freddo, per plastica rigida. Rapida aderenza iniziale che consente piccole correzioni, facilitando l'incollaggio di grandi dimensioni.
- PT Adesivo ou soldadura química em frio, para plásticos rígidos, aderência rápida permitindo pequenas correções, facilitando a colagem em grandes coladas.

Ref				
1500 1176	60 ml	1	10	2,91

FIJADOR Y SELLADOR DE ALTA RESISTENCIA / BLOQUANT HAUTE RÉSISTANCE / NUTLOCK HIGH STRENGTH  
BLOCCANTE DI ALTA RESISTENZA / FIXADOR E VEDANTE DE ALTARESISTÊNCIA



- ES PROPIEDADES: Especial para uniones de solitud elevada. Desmontable aplicando calor (300°C). No necesita activadores para su curado. No crea problemas de fijación. Fija y sella tuercas, tornillos, espárragos, etc.
- FR PROPRIETES: Spécial pour assemblage de fixation forte. Désassemblage normal. Ne nécessite pas d'activateur pour son traitement. Ne crée pas de problème de fixation. Fixe et bloque vis, écrous, etc.
- EN DESCRIPTION: Can be undone applying heat (300°C). It does not need activators for curing. Prevents loosening. Special for nuts, screws, etc.
- IT PROPIETÀ: Ideale per fissaggi ad alta resistenza. Smontabile applicando calore di 300 °C. Non necessita di attivatori per ottenere il suo effetto. Non crea problemi di fissaggio. Fissa e mantiene viti, dadi, ecc.
- PT PROPRIEDADES: Especial para uniões de aplicação elevada. Não precisa de ativadores. Sem problemas de fixação. Fixa e veda porcas, parafusos, pregos, etc.

Ref				
1500 0270	50 ml	1	12	11,96

FIJADOR Y SELLADOR DE MEDIA RESISTENCIA / BLOQUANT MOYENNE RESISTANCE / NUTLOCK MEDIUM STRENGTH  
BLOCCANTE DI MEDIA RESISTENZA / FIXADOR E VEDANTE DE MÉDIA RESISTÊNCIA



- ES PROPIEDADES: Especial para uniones de solitud media. Desmontable con herramientas normales. No necesita activadores para su curado. No crea problemas de fijación. Fija y sella tuercas, tornillos, espárragos, etc.
- FR PROPRIETES: Spécial pour assemblage de fixation moyenne. Désassemblage avec outil normal. Ne nécessite pas d'activateur pour son traitement. Ne crée pas de problème de fixation. Rapidité de traitement. Fixe et bloque vis, écrous, etc.
- EN DESCRIPTION: Ideal for replacing all locking nut devices. Can be undone using normal workshop tools. It does not need activators for curing. Prevents loosening. Specially for nuts, screws, etc.
- IT PROPIETÀ: Ideale per fissaggi di media resistenza. Smontabile con normali strumenti e non necessita di attivatori per ottenere il suo effetto. Non crea problemi di fissaggio. Fissa e mantiene viti, dadi, ecc.
- PT PROPRIEDADES: especial para uniões de aplicação média. Removível com ferramentas normais. Não precisa de ativadores. Sem problemas de fixação. Fixa e veda porcas, parafusos, pregos, etc.

Ref				
1500 0243	50 ml	1	12	11,96

PTFE LÍQUIDO / PTFE LIQUIDE / PIPESEAL / PTFE LIQUIDO / PTFE LÍQUIDO



- ES PROPIEDADES: Especial para tuberías de alta presión. Se consigue una unión extremadamente estanca. No corroe las partes roscadas. Sin disolvente. No crea problemas de fijación. Sellador de todas las uniones y tuberías de alta presión. Sustituye al cáñamo y al ptefe en cinta o en rollo.
- FR PROPRIETES: Spécial pour flexibles de haute pression. Permet une excellente étanchéité. Ne Bouche pas les parties filetées, sans dissolvant. Ne crée pas de problème de fixation. Parfait pour tous les raccords et flexibles de haute pression.
- EN DESCRIPTION: Locks and seals threaded pipe fittings. Seals out moisture to prevent corrosion. Use on common water, oil, gas and air fittings. Replaces the need of pipe tapes and dopes.
- IT PROPIETÀ: Ideale per raccordi e tubazioni ad alte pressioni. Offre un'eccellente tenuta stagna. Non corrode le parti filettate e non contiene solventi. Non crea problemi di fissaggio. Sostituisce la canapa e nastri ptefe.
- PT PROPRIEDADES: Especial para tubos de alta pressão. Consegue uma união extremamente vedada. Sem corroer as peças da rosca. Sem solvente. Sem problemas de fixação. Vedante de todas as articulações e os tubos de alta pressão. Substitui o cânhamo e o PTFE em fita e em rolo.

Ref				
1500 0567	50 ml	1	12	12,17



DESOXIDANTE AFLOJATODO / DEGRIPPANT MULTIFONCTION / PENETRATING OIL / DISSODANTE SBLOCCANTE / ÓLEO PENETRANTE

**GRAN PODER DESOXIDANTE, 0'5% POLVO MICRONIZADO DE BISULFURO DE MOLIBDENO**



Ref				
<b>0450 0001</b>	400 ml	1	12	<b>72,45</b>
<b>0450 0002</b>	200 ml	1	20	<b>99,75</b>

ES Aerosol lubricante aflojatodo con propiedades desbloqueantes, alto poder desoxidante y efecto muy prolongado. El polvo micronizado de disulfuro de molibdeno facilita su poder desbloqueante y deslizante. El polvo de bisulfuro forma una capa lubricante con muy bajo coeficiente de fricción y una adherencia excelente, incluso en condiciones extremas de presión y temperatura. Evita procesos de oxidación.

FR Spray lubrifiant dégrissant aux propriétés débloquentes, pouvoir désoxydant élevé et effet très longue durée. La poudre de bisulfure de molybdène micronisée facilite son pouvoir de déblocage et de glissement. La poudre de disulfure forme une couche lubrifiante avec un coefficient de frottement très bas et une excellente adhérence, même dans des conditions extrêmes de pression et de température. Empêche les processus d'oxydation.

EN This penetrating oil lubricates, loosens, removes rust and protects parts for a long time. The material contains molybdenum disulphide powder to afford a loosening and slippery effect. It forms a lubricating layer that provides a very low coefficient of friction and an excellent adherence even under extreme conditions of heat and pressure. Avoids the oxidation.

IT Spray lubrificante con proprietà sbloccanti. La presenza di polvere micronizzata di bisolfuro di molibdeno agevola ed esalta il potere sbloccante e scivolante. La polvere di bisolfuro forma uno strato lubrificante con bassissimo coefficiente di attrito ed un'eccellente adesività anche in condizioni di pressioni e temperature estreme. Previene il formarsi di nuove ossidazioni lasciando un velo protettivo.

PT Aerosol de óleo penetrante com propriedades desbloqueantes, alto poder desoxidante e de efeito muito prolongado. O pó de bisulfuro de móbdeno facilita o seu poder desbloquante e deslizante com baixo coeficiente de fricção e uma aderência excelente, inclusive em condições extremas de pressão e temperatura. previne processos de oxidação.

Ref				
<b>1500 0001</b>	400 ml	1	12	<b>5,93</b>
<b>1500 0002</b>	200 ml	1	12	<b>4,83</b>

AFLOJATODO EFECTO FRÍO / ICE SBLOCK CONTRE LA ROUILLE / "FREEZE" EFFECT RUST BREAKER  
ICE SBLOCK SPACCARUGGINE / EFEITO GELO CONTRA CORROSAO



ES Aflojatodo con efecto frío. Una formulación creada específicamente para romper, quebrar, disolver y remover el óxido. Penetra y lubrica la capa de óxido a la vez que congela y rompe sus moléculas.

FR Ice sblock contre la rouille. Une nouvelle formulation pour détacher et éliminer même la rouille la plus résistante. Le produit pénètre et lubrifie la couche de rouille à la fois en congelant ses molécules.

EN "Freeze" effect rust breaker. A new formulation specifically developed for the breaking up and removal even of the most resistant rust. The product penetrates and lubricates the rust layer 'freezing' at the same time its molecules.

IT Ice sblock spaccaruggine. Prodotto di nuova formulazione, adatto alla rimozione della ruggine piu resistente e stratificata; ad alto potere penetrante e lubrificante, lo spray ghiaccia, rompe e separa le molecole che compongono la ruggine.

PT Efeito gelo contra corrosão. Uma nova fórmula desenvolvida especificamente para a quebra e remoção da ferrugem, mesmo as mais resistentes. O produto penetra e lubrifica a camada de oxidação, ao mesmo tempo que congela e rompe as suas moléculas.

Ref				
<b>1500 0006</b>	400 ml	1	12	<b>7,42</b>

LUBRICANTE PARA BICICLETAS 200 ML / LUBRIFIANT POUR BICYCLETES / BICYCLE LUBRICANT  
LUBRIFICANTE PER BICICLETTA / OLEO LUBRIFICANTE PARA BICICLETAS



ES Aerosol antigripante y lubricante para cadenas de bicicletas y partes mecánicas. Permite el correcto funcionamiento de todos los mecanismos tratados, aumentando la prestación mecánica.

FR Aérosol antigrippant et lubrifiant pour les chaînes a velo et les parties mécaniques. Permet un bon fonctionnement de tous les mécanismes traités, et augmente la prestation mécanique.

EN Anti-seize and grease spray for bikes chains and mechanical parts. It allows the proper operation on the mechanical parts treated increasing the performance.

IT Spray antigrippante e lubrificante per catene di bicicletta e parti meccaniche. Permette il corretto funzionamento di tutti i meccanismi trattati, aumentando la prestazione meccanica.

PT Aerosol antigripante e lubrificante para correntes de bicicletas e partes mecánicas. Permite o correcto funcionamento de todos os mecanismos tratados, aumentando a prestação mecánica.

Ref				
<b>1500 0042</b>	200 ml	1	12	<b>7,55</b>





LUBRICANTE PARA ARMAS 200 ML / LUBRIFIANT POUR ARMES / WEAPONS LUBRICANT / LUBRIFICANTE PER ARMI / LUBRIFICANTE PARA ARMAS



- ES Lubricante protector para las partes mecánicas de las armas. Inhibe el efecto corrosivo de la pólvora, indispensable para las operaciones de manutención.
- FR Protecteur lubrifiant pour les parties mécaniques des armes à feu. Inhibe l'effet corrosif de la poudre, indispensable pour les opérations de maintenance.
- EN Protector grease for guns' mechanical parts. Inhibit the corrosive effect from the gunpowder, essential for the gun maintenance.
- IT Lubrificante protettivo per le parti meccaniche delle armi. Inibisce l'effetto corrosivo della polvere da sparo, indispensabile per le operazioni di manutenzione.
- PT Lubrificante protector para as partes mecánicas das armas. Inibe o efeito corrosivo da pólvora, indispensavel para as operações de manutenção.

Ref				
1500 0025	200 ml	1	12	7,55

ACEITE CORTE Y TALADRO EN SPRAY 400 ml / HUILE COUPE ET FORET / OIL FOR CUTTING AND DRILLING / OLIO DA TAGLIO E FILETTATURA / ÓLEO, CORTE E PERFURAÇÃO



- ES Taladrina en spray; Alarga, impide roturas y protege el rendimiento de herramientas dedicadas al corte y taladro.
- FR Conditionnée en spray ; Evite la casse et protège le rendement des outils pour coupe et foret.
- EN Cutting uid in spray; Extends the life, avoids breakdowns and protects the performance of any cutting and drilling tool.
- IT Spray; Allarga, impedisce rotture e protegge le prestazioni degli strumenti dedicati al taglio ed alla foratura.
- PT Refrigeração em spray; Prolonga, impede rupturas e protege o desempenho das ferramentas dedicadas ao corte e á perfuração.

Ref				
1500 1029	400 ml	1	6	10,44

LUBRICANTE DESBLOQUEANTE PROTECTOR / LUBRIFIANT DEBLOQUANT DE PROTECTION / UNLOCKING PROTECTIVE LUBRICATING AGENT / LUBRIFICANTE SBLOCCANTE PROTETTIVO / LUBRIFICANTE DESBLOQUEAMENTO PROTECTOR



- ES Aflojatado desbloqueante líquido especial para evitar el óxido, limpieza de piezas, protector de la humedad y propiedades para aflojar uniones roscadas como tornillos y tuercas.
- FR Dégrippant débloquant liquide spécialement conçu pour éviter l'oxydation, pour le nettoyage des pièces, pour la protection contre l'humidité et disposant de propriétés pour dégripper unions filettées, vis et écrous.
- EN Rust breaker, unlocking protective lubricating agent for preventing rust. It is used for cleaning pieces, for protection against humidity, and contains properties that loosen threaded joints such as nuts and bolts.
- IT Sbloccante liquido specificamente progettato per prevenire la ruggine. Pulisce i componenti, li protegge dall'umidità e previene il grippaggio di giunzioni filettate come viti e bulloni.
- PT Líquido removedor especial para evitar a ferrugem, limpeza de peças, protetor da humidade e propriedades para soltar as ligações roscadas como parafusos e porcas.

Ref			
1500 0068	5 L	1	57,20

ACEITE DE CORTE (TALADRINA) / HUILE DE COUPE (LIQUIDE DE COUPE) / CUTTING OIL / OLIO DA TAGLIO / ÓLEO DE CORTE (REFRIGERANTE)



- ES Aceite de corte especial para ser usado universalmente en máquinas automáticas, en materiales metálicos y no metálicos con amplias propiedades de lubricación y refrigeración.
- FR Huile de coupe spéciale pour être universellement utilisée sur des machines automatiques, matériaux métalliques et non métalliques avec de vastes propriétés de lubrification et de réfrigération.
- EN Cutting oil for being used in any kind of automatic machines, metallic and non metallic materials, with a wide range of lubricating and cooling properties.
- IT Olio da taglio con impiego universale su macchine automatiche, materiali metallici e non metallici e dotato di ampie proprietà lubrificanti e di raffreddamento.
- PT Óleo de corte especial para ser utilizado universalmente em máquinas automáticas, em materiais metálicos e não metálicos com amplas propriedades de lubrificação e refrigeração.

Ref			
1500 0069	5 L	1	85,80

 ACEITE DE CORTE EMULSIONABLE / HUILE DE COUPE ÉMULSIONABLE / EMULSIFIABLE CUTTING OIL  
 OLIO DA TAGLIO EMULSIONABILE / ÓLEO DE CORTE EMULSIONÁVEL

- ES Aceite corte emulsionable para materiales férricos y no férricos como el aluminio o aleaciones. Es posible diluirlo al 5% y protege de la corrosión tanto en piezas elaboradas como las máquinas y herramientas.
- FR Huile de coupe emulsionable pour matériaux ferriques et non ferriques comme l'aluminium ou les alliages. Il est possible de la diluer à 5% pour protéger de la corrosion autant sur des pièces élaborées comme les machines et les outils.
- EN Emulsifiable cutting oil for ferrous and non-ferrous materials such as aluminium or alloys. It is possible to dilute 5% and it provides corrosion protection to manufactured pieces, machines and tools.
- IT Olio da taglio emulsionabile per materiali ferrosi e non ferrosi come alluminio o leghe. È possibile diluirlo al 5% e protegge dalla corrosione sia pezzi elaborati, sia macchinari e utensili.
- PT Óleo de corte emulsionável para materiais ferrosos e não-ferrosos tais como alumínio ou ligas. Pode diluir 5% e protege contra a corrosão, em ambas as peças feitas como máquinas e ferramentas.

Ref			
1500 0070	5 L	1	85,80

## ACEITE FINO DE VASELINA / HUILE FINE DE VASELINE / VASELINE OIL / OLIO DI VASELINA / ÓLEO FINO DE VASELINA



- ES Aceite fino de vaselina incoloro sin materiales pesados, usado para lubricación de máquinas de coser, electrodomésticos, automoción e industria.
- FR Huile de vaseline fine incoloro sans matériau lourd, utilisé pour la lubrification de machines de coudre, d'appareils électroménagers, dans le secteur automobile et dans l'industrie.
- EN Colourless vaseline oil, no heavy materials, used for lubricating sewing machines, electrical appliances, automotive sector and industry.
- IT Olio di vaselina incoloro senza materiali pesanti, utilizzato per la lubrificazione di macchine da cucire, elettrodomestici e nel settore automobilistico e industriale.
- PT Óleo fino de vaselina incolor sem materiais pesados, utilizado para a lubrificação de máquinas de costura, eletrodomésticos, automotivo e indústria.

Ref				
1500 0058	400 ml	1	6	8,24

 GRASA DE BISULFURO DE MOLIBDENO / GRAISSE AU MOLYBDENE BISULFURE / MOLYBDENUM DISULPHUROUS GREASE  
 GRASSO AL BISOLFURO DI MOLIBDENO / LUBRIFICANTE DISSOLFETO DE MOLIBDÊNIO

- ES Grasa de bisulfuro de molibdeno. Excepcionales propiedades antigripantes, antibloqueantes y lubricantes. Producto adecuado para operaciones en condiciones de presiones y temperaturas extremas -180°C hasta +380°C.
- FR Graisse au molybdene bisulfure. Remarquables propriétés dégrrippantes, antichoc et lubrifiantes. Pour des grandes pressions et hautes températures. Conserve ses propriétés entre -180°C à +380°C.
- EN Molybdenum disulphurous grease. Outstanding antigrip, anti locking and lubricating properties. For operations in conditions of extreme pressures and high temperatures. Range: from -180°C to +380°C.
- IT Grasso al bisolfuro di molibdeno. Il prodotto ha ottime caratteristiche antigrippanti, antibloccanti e lubrificanti. Resiste a pressioni estreme e ad alte temperature. Mantiene inalterate le sue proprietà da -180°C a +380°C.
- PT Lubrificante de dissulfeto de molibdênio. Excepcionais propriedades anti-aderente, antibloqueio e lubrificantes. Produto apropriado para operações em condições de pressão e temperatura (-180 °C a +380 °C) extremas.

Ref				
1500 0003	400 ml	1	12	7,21

## GRASA BLANCA DE LITIO + PTFE / GRAISSE AU LITHIUM + PTFE / LITHIUM GREASE + PTFE / GRASSO AL LITIO + PTFE / LUBRIFICANTE DE LÍTIO + PTFE



- ES Grasa blanca de litio + PTFE. Óptimas propiedades adhesivas, protectoras y deslizantes. Penetra en profundidad y garantiza una lubricación duradera.
- FR Graisse au lithium + PTFE. Le produit est utilisé dans plusieurs secteurs industriels. Excellentes propriétés adhesives, protectrices et glissantes. Pénètre en profondeur et garantit une lubrification longue durée.
- EN Lithium grease + PTFE. Spray largely used for industrial applications. Adhesive, protective and sliding properties; allows for a lasting and high quality lubrication.
- IT Grasso al litio + PTFE. Trova applicazione in molti settori industriali. Ottime proprietà adesive, protettive e scivolanti. Penetra in profondità ed assicura una lubrificazione duratura.
- PT Lubrificante de lítio + PTFE. Propriedades adesivas, protetoras e deslizantes, excelentes. Penetra em profundidade e garante uma lubrificação duradoura.

Ref				
1500 0007	400 ml	1	12	7,54



GRASA ADHESIVA PARA CADENAS / GRAISSE FILANTE MULTI-USAGES / RUNNING MULTIPURPOSE GREASE  
LUBRIFICANTE LIQUIDO PER CATENE / LUBRIFICANTE ADESIVO PARA CORRENTES



- ES Grasa adhesiva para cadenas. Grasa líquida con propiedades adhesivas para una lubricación duradera. Protege del deterioro y de la oxidación las partes tratadas. Resistente al agua salada y a fuertes cambios de temperatura.
- FR Graisse filante multi-usages. Produit multi-usages avec un pouvoir adhésif qui permet une lubrification durable. Protège les parties de l'usure et l'oxydation. Résistant à l'eau de mer et aux grands changements de température.
- EN Running multipurpose grease. A multipurpose product with adhesive properties for a long lasting lubrication. Protects treated parts from wear and oxidation. Resistant to salt water and high temperatures.
- IT Lubrificante liquido per catene. Grasso multiuso con proprietà adesive che conferiscono una lubrificazione duratura e protezione dall'usura e dall'ossidazione. Resistente all'acqua salata ed agli sbalzi di temperatura.
- PT Lubrificante adesivo para correntes. Lubrificante líquido com propriedades adesivas para lubrificação de longa duração. Proteje da deterioração e oxidação das peças tratadas. Resistente à água salgada e mudanças de temperatura elevada.

Ref				
1500 0004	400 ml	1	12	7,21

GRASA DE VASELINA / GRAISSE DE VASELINE / VASELINE GREASE / GRASSO DI VASELINA / VASELINA



- ES Grasa de vaselina de color rosa sin materiales pesados, ideal para el mantenimiento donde existe el desgaste y rozamiento por piezas de metal con plástico.
- FR Graisse de vaseline couleur rosée sans matériau lourd, idéal pour l'entretien si présence d'usure et de frottement pour des pièces en métal avec plastique.
- EN Pink vaseline grease, no heavy materials, ideal for the maintenance of those areas which are likely to be worn out or in case of friction between metal parts with plastic.
- IT Grasso di vaselina di colore rosa, senza materiali pesanti. Ideale per la manutenzione di componenti usurati o in caso di attrito tra parti metalliche con plastica.
- PT Vaseline rosa sem materiais pesados, ideal para a manutenção onde existe atrito e de desgaste de peças de metal com plástico.

Ref				
1500 0059	400 ml	1	6	8,30

GRASA NÁUTICA 400 ml / GRAISSE SECTEUR NAUTIQUE / NAUTICAL GREASE / GRASSO PER NAUTICA / LUBRIFICANTE NÁUTICO



- ES Grasa repelente al agua. Ideal para lubricar zonas que están expuestas al agua salada, una solución duradera para la protección de abrazaderas, cables y partes de un barco.
- FR Graisse résistante à l'eau. Idéal pour lubrifier des zones qui sont exposées à l'eau salée, une solution durable pour la protection des colliers, des cables et autres pièces d'un bateau.
- EN Grease repelent to water. Ideal to lubricate areas exposed to salty water. a long life solution to keep hoses, wires and boat's parts protected.
- IT Grasso idrorepellente. Ideale per lubrificare zone esposte all'acqua salata. offre una soluzione duratura per la protezione di fascette, cavi e parti di una imbarcazione.
- PT Oleo repelente a agua. Ideal para lubrificar zonas que estão expuestas a água salgada, uma solução duradeira para a proteção de abraçadeiras, cabos e partes de um barco.

Ref				
1500 0051	400 ml	1	12	8,69

PROTECTOR BORNES DE BATERÍA 400 ML / SPRAY PROTECTION BORNES DE BATTERIE / BATTERY TERMINAL PROTECTOR  
PROTEZIONE MORSETTI BATTERIA / PROTETOR TERMINAIS DE BATERIA



- ES Agente protector antiácido para bornes de batería. Es el producto ideal para prevenir la sulfatación y la corrosión de los bornes de cobre o bronce. Resiste grandes variaciones de temperatura.
- FR Agent protecteur anti-acide pour les bornes de batterie. C'est le produit idéal pour le traitement du sulfate et la corrosion des bornes en cuivre ou en bronze. Il résiste à de grandes variations de température.
- EN Battery terminals antacid protector. It is ideal to prevent sulphating and corrosion of the copper and bronze terminals. It resists large temperature fluctuations.
- IT Agente protettivo antiacido per terminali della batteria. Prodotto ideale per prevenire la solfatazione e la corrosione dei terminali di rame o bronzo. Resiste a grandi variazioni di temperatura.
- PT Agente protector antiácido para bornes de batería. É o produto ideal para prevenir a sulfatação e a corrosão de os bornes de cobre ou bronze. Resiste a grandes variações de temperatura.

Ref				
1500 0056	400 ml	1	12	8,92

 LIMPIADOR DE FRENOS Y EMBRAGUES 500 ML / NETTOYANT POUR FREINS ET FRICTIONS / BRAKES AND CLUTCHES CLEANER  
 PULITORE FRENI E FRIZIONI / LIMPADOR DE TRAVÕES E EMBRAIAGENS

- ES Producto desarrollado y formulado específicamente para la limpieza de frenos y embragues. Ideal para abrazaderas y cilindros. Seca rápidamente sin dejar residuos.
- FR Produit élaboré pour le nettoyage parfait des freins à disque, à tambour et frictions. Agit rapidement sans laisser aucune trace.
- EN Product specifically developed and formulated for the cleaning of car brakes and clutches. Ideal on clamps and cylinders. Quick drying, no remainders.
- IT La formulazione del prodotto è stata sviluppata per una pulizia ottimale di freni a disco, freni a tamburo, frizioni. Asciuga rapidamente, non lascia residui.
- PT Produto desenvolvido e formulado especificamente para a limpeza de freios e embraiagens. Ideal para grampos e cilindros. Seca rapidamente sem deixar nenhum resíduo.

Ref				
1500 0010	500 ml	1	6	7,23

## LIMPIADOR PARA METALES / NETTOYANT POUR MÉTAUX / BRASS CLEANER / PULITORE PER METALLI / LIMPADOR DE METAIS



- ES Para la limpieza de metales y acero inoxidable. Elimina huellas dactilares, grasas y residuos de aceite, su película protectora presenta propiedades antioxidantes y antipolvo. Empleado en equipamientos de cocina y catering, instrumentos hospitalarios y de manipulación de alimentos.
- FR Pour le nettoyage des parties en acier inoxydable ou en métal poli. Élimine les traces de doigts, graisses et résidus huileux; laisse un film protecteur contre les poussières et l'oxydation. S'utilise pour les équipements pour service de restauration, hôpitals et tous les ustensiles de cuisine.
- EN For the cleaning of stainless steel parts. Removes fingerprints, greases and oily remainders; its protective film has anti-dust and antioxidant properties. Used for catering and cooking equipment, hospital and food handling appliances.
- IT Prodotto specifico per la pulizia di parti in acciaio inox o superfici metalliche lucide. Elimina impronte digitali, grassi, untuosità varie lasciando un film protettivo che agisce da antipolvere ed antiossidante. Ideale per banchi frigo, bar, piani cottura, cappe, lavelli.
- PT Para a limpeza de metais e de aço inoxidável. Remove as impressões digitais, gordura e resíduos de óleo, a sua película protetora tem propriedades antioxidantes e anti-poeira. Usado em equipamentos de cozinha e "catering", instrumentos hospitalares e manipulação de alimentos.

Ref				
1500 0012	400 ml	1	12	8,37

 LIMPIADOR DE CONTACTOS ELÉCTRICOS / DÉSOXYDANT A BASE D'HUILE POUR CONTACTS ÉLECTRIQUES / DEOXIDIZER FOR ELECTRIC CONTACTS  
 DISSODIANTE OLEOSO PER CONTATTI ELETTRICI / DESOXIDANTE PARA CONTATOS ELÉTRICOS

- ES Limpiador de contactos eléctricos Apropiado para equipos eléctricos, relés, contactos, centralitas, semiconductores. Evapora muy rápido y sin dejar residuos.
- FR Désoxydant a base d'huile pour contacts électriques. S'utilise pour les équipements électriques et électroniques, relais électriques, tableaux de distribution, semi-conducteurs. Pénètre rapidement et facilement dans les zones difficiles d'accès. Évaporation rapide, hydrofuge, prévient la corrosion.
- EN Deoxidizer for electric contacts. Suitable for electric equipment, relays, contacts, switchboards, semi-conductors. Penetrates quickly and easily in otherwise hard to reach areas. Quick evaporation, no remainders.
- IT Dissodiante oleoso per contatti elettrici. Spray idoneo per apparecchiature elettriche, relé, contatti, centraline e semiconduttori. Penetra rapidamente e con facilità in zone altrimenti di difficile accesso. Ha una rapida evaporazione, è idrorepellente e previene la corrosione.
- PT Dexoxidante para contatos elétricos. Adequado para equipamentos elétricos, relés, contatos, centralinas, semicondutores. Evapora-se muito rapidamente e sem deixar resíduos.

Ref				
1500 0005	400 ml	1	12	6,77

## LIMPIADOR ALQUITRÁN 400 ML / NETTOYANT GOUDRON / TAR CLEANER / DETERGENTE CATRAME / TIRA ALCATRAO



- ES Producto específico para quitar los residuos de alquitrán, resina y pegamento de la carrocería. Es también perfecto para las partes de metal, goma o plástico.
- FR Produit spécifique pour enlever les résidus de goudron, de résine et de colle sur la carrosserie. Parfait pour les parties en métal, en caoutchouc ou en plastique.
- EN Specific product to eliminate tar waste, resin and glue from the car body. It is also perfect for metal, rubber or plastic parts.
- IT Prodotto specifico per rimuovere i residui di catrame, resina e colla della carrozzeria. Perfetto anche per le parti metalliche, gomma e plastica.
- PT Produto específico para retirar os resíduos de alcatrao, resina e cola da carrocería. É também perfeito para as partes de metal, borracha ou plástico.

Ref				
1500 0054	400 ml	1	12	9,15



LIMPIADOR DE CHICLE 400 ML / NETTOYANT CHEWING-GUM / CHEWING-GUM REMOVAL / RIMUOVI CHEWIN-GUM / SPRAY PARA REMOVER CHICLE



ES Quita chicle y goma plástica solidificada en cualquier tipo de tejido y superficie dura. El producto también puede ser usado en PVC, madera o piedra.

FR Enleve le chewing-gum et le plastique solidifié sur tout type de tissu et de surface solide. Produit peut également être utilisé sur le pvc, le bois ou la pierre.

EN Gum removal and solidified plastic rubber from any type of fabric or hard surface. It can be use on pvc, wood or stone.

IT Rimuove chewing gum e gomma plastica solidificata su qualsiasi tessuto e superficie dura. Il prodotto può essere utilizzato anche su pvc, legno o pietra.

PT Retira chicle e goma plástica solidificada em qualquer tipo de tecido e superfície dura. O produto também pode ser usado em pvc, madeira ou pedra.

Ref				
1500 0055	500 ml	1	6	10,50

ESPUMA SUPERLIMPIADORA EN SPRAY 400 ML / MOUSSE SUPER NETTOYANTE / SUPER CLEANING FOAM  
SCHIUMA DETERGENTE / SUPER ESPUMA DE LIMPEZA



ES Espuma limpiadora con olor agradable y excelente poder de limpieza en cualquier tipo de superficie.

FR Mousse nettoyeuse avec parfum agréable et excellent pouvoir de nettoyage sur tout type de surface.

EN Foam cleaner with pleasant smell and excellent cleaning power of any surface.

IT Schiuma detergente con odore gradevole ed eccellente potere pulente su qualsiasi tipo di superficie.

PT Espuma de limpeza com cheiro agradável e excelente poder de limpeza em qualquer tipo de superfície.

Ref				
1500 1026	400 ml	1	6	8,52

LIMPIADOR SALPICADEROS CON SILICONA 600 ML / NETTOYANT SALPICADEROS AVEC SILICONE / DASHBOARD CLEANER WITH SILICONE  
DETERGENTE PER CRUSCOTTO CON SILICONE / LIMPADOR PAINEL DE INSTRUMENTOS COM SILICONA



ES Limpia, da brillo y protege de la suciedad, polvo y de los rayos UVA los salpicaderos y todas las partes plásticas del vehículo. Prolonga la vida de las partes tratadas.

FR Nettoie, fait briller et protège contre les impuretés, la poussière et les rayons uv, les tableaux de bord et toutes les parties plastiques du véhicule. Prolonge la durée de vie des parties traitées.

EN Clean, brighten and protect from dust, the sun lights, dashboard and other plastics from vehicle. Improve the life of the treated area.

IT Pulisce, lucida e protegge da sporcizia, polvere e raggi uva. adatto per cruscotti e tutte le componenti plastiche del veicolo. Prolunga la vita delle parti trattate.

PT Limpa, da brilho e protege da sujidade, pó e de os raios x, o painel de instrumentos e todas as partes plásticas do veículo. Prolonga a vida das partes tratadas.

Ref				
1500 0024	600 ml	1	24	8,69

ABRILLANTADOR DE NEUMÁTICOS 400 ML / NETTOYANT ET LUSTRANT POUR LES PNEUS / TIRES POLISHER  
BRILLANTANTE PNEUMATICI / ABRILHANTADOR DE PNEUS



ES Limpia, da brillo y revitaliza los neumáticos y todas las partes de goma de los coches. Efecto duradero.

FR Nettoie, fait briller et renove les pneus et toutes les pieces en caoutchouc des voitures. Effet durable.

EN Clean, brighten and revitalize the tyres and all rubber parts on the cars. Long life effect.

IT Pulisce, lucida e ravviva i pneumatici e tutti le parti in gomma della vettura. Effetto duraturo.

PT Limpa, da brilho e revitaliza os pneus e todas as partes da viatura que levam borracha. Efeito duradeiro.

Ref				
1500 0052	400 ml	1	12	8,24





REPARADOR DE PINCHAZOS 300 ML / SPRAY ANTI CREVAISON / FLAT TIRE FIXER / RIPARA PNEUMATICI / REPARADOR DE FUROS



- ES Incha y repara instantáneamente cualquier tipo de rueda. No daña el neumático o la cámara de aire, permitiendo su reparación. La solución más rápida, limpia y eficaz en caso de rueda pinchada.
- FR Gonfle et répare instantanément tout type de roue. Il n'endommage pas le pneu ou la chambre a air, permet sa réparation. C'est la solution la plus rapide, propre et efficace en cas de roue crevee.
- EN Inflate and repair immediately any type of wheel. It does not damage the flat tyre or the air chamber allowing its reparation. The cleanest, quickness and efficient solution for a flat tyre.
- IT Gonfia e ripara istantaneamente qualsiasi tipo di ruota. Non danneggia il pneumatico o la camera d'aria, permettendo la riparazione. La soluzione più rapida ed efficace in caso di ruota forata.
- PT Enche e repara instantaneamente qualquer tipo de roda. Nao danifica o pneu ou a câmara de ar, permitindo a sua reparação. A solução mais rápida, limpa e é eficaz em caso de se ter uma roda furada.

Ref				
1500 0053	300 ml	1	12	11,42

HIGIENIZANTE DESECHABLE MONODOSE / MONODOSE SOLUTION HYGIENIQUE JETABLE / DISPOSABLE SANITISER SINGLE USE  
IGIENIZZANTE MONOUSO / PRODUTO DE HIGIENIZAÇÃO DESCARTÁVEL MONODOSE



- ES Higienizante en spray ideal para una rápida acción higienizante de vehículos y espacios pequeños. Elimina los malos olores. Activar el spray, cerrar las puertas y dejar actuar durante 15 minutos. Ventilar durante unos minutos.
- FR Produit en spray idéal pour une action assainissante rapide et efficace dans les voitures et les petits espaces. Il neutralise les mauvaises odeurs. Laisser agir le produit pendant au moins 15 minutes, puis aérer l'habitacle ou la pièce pendant quelques minutes.
- EN Spray sanitiser ideal for a quick and effective sanitiser action of passenger cars and small rooms. It eliminates bad smells. Let the product act for at least 15 minutes. Ventilate the vehicle or the room for a few minutes.
- IT Prodotto spray ideale per una rapida ed efficace azione igienizzante di autovetture e piccoli ambienti. Neutralizza i cattivi odori. Lasciare agire il prodotto per almeno 15 minuti, quindi areare l'abitacolo od il locale per qualche minuto.
- PT Produto em spray, de acção desinfetante rápida e eficaz para automóveis e pequenos espaços. Neutraliza os maus odores. Deixe actuar pelo menos durante 15 minutos e deixe arejar durante alguns minutos.

Ref				
1500 0079	200 ml	1	6	7,86

HIGIENIZANTE AMBIENTADOR / DIFFUSEUR HYGIENIQUE D'AMBIANCE / ENVIRONMENT SANITISER  
IGIENIZZANTE AMBIENTE / AMBIENTADOR DE HIGIENIZAÇÃO



- ES Aerosol seco ideal para una acción higienizante rápida y eficaz en distintos ambientes tales como la casa, oficinas, habitaciones de hotel, coches, vehículos de camping, autobuses, embarcaciones, etc. Neutraliza los malos olores causados por microorganismos y sustancias orgánicas de olor desagradable. Refresca de inmediato el ambiente.
- FR Produit en spray sec idéal pour une action hygiénisante rapide et efficace dans des espaces différents tels que: maisons, bureaux, chambres d'hôtel, voitures, camping-cars, bus, bateaux, etc. Il neutralise les mauvaises odeurs causées par des micro-organismes et des substances organiques malodorantes. Il rafraîchit immédiatement la pièce.
- EN Dry spray product providing quick and effective sanitiser action, ideal for different places such as: home, offices, hotel rooms, cars, caravans, buses, boats, etc. It neutralises bad smells caused by microorganisms and organic substances. It refreshes the environment immediately.
- IT Prodotto spray secco ideale per una rapida ed efficace azione igienizzante di casa, uffici, camere d'albergo, autovetture, camper, pullman, imbarcazioni, ecc. Neutralizza i cattivi odori causati da microrganismi e sostanze organiche maleodoranti. Rinfresca immediatamente l'ambiente.
- PT Produto spray seco ideal para uma rápida e eficaz acção higienizadora de casa, escritórios, quartos de hotel, veículos, caravana, autocarros, embarcações, etc. Neutraliza os odores desagradáveis causados por microorganismos e substâncias orgánicas malcheirosas. Refresca imediatamente o ambiente.

Ref				
1500 0080	400 ml	1	12	9,17

HIGIENIZANTE AIRE ACONDICIONADO 400 ML / SPRAY HYGIENE AIR CONDITIONNÉ / AIR CONDITIONING SYSTEM HYGENIZER  
IGIENIZZANTE IMPIANTO CONDIZIONATORE / HIGIENIZANTE PARA SISTEMAS AR CONDICIONADO



- ES Elimina hongos, mohos, bacterias y microorganismos de los equipos de aire acondicionado. El producto es adecuado para sistemas de aire acondicionado doméstico o de automóvil. Incluye cánula 60 cm.
- FR Élimine champignons, moisissures, bactéries et micro-organismes des outils d'air conditionné. Le produit est approprié pour les systèmes d'air conditionné domestiques des automobiles. Inclut canule 60 cm.
- EN Eliminates fungi, bacteria, microorganisms from air conditioning systems. It is suitable for vehicles air conditioning. 60 cm cannula included.
- IT Elimina funghi, muffe, batteri e microorganismi degli impianti di aria condizionata. Il prodotto adeguato per sistemi di climatizzazione domestica dell'automobile. include cannula di 60cm.
- PT Elimina fungos, blor, bacterias e microorganismos de os equipamentos de ar condicionado. O produto é adequado para sistemas de ar condicionado doméstico de automóvel. Inclui canula 60 cm.

Ref				
1500 0040	400 ml	1	12	8,69



AUTOARRANQUE TODOCLIMA 400 ML / AIDE AU DEMARRAGE / AUTO START SPRAY / AVVIAMENTO RAPIDO / AUTO ARRANQUE



- ES Ideal para el arranque rápido o ayuda en ambientes fríos. Para diésel y gasolina.
- FR Idéal pour le démarrage rapide ou aide en atmosphères froides, pour diesel et essence.
- EN Perfect for a quick start-up or as help in cold environments. For diesel and gasoline.
- IT Ideale per l'avviamento rapido e come supporto in ambienti freddi, per diesel e benzina.
- PT Ideal para o arranque rápido ou ajuda em ambientes frios, para diesel e gasolina.

Ref				
1500 1027	400 ml	1	6	8,52

ANTIADHESIVO PARA SOLDADURAS 300 ML / ANTI-ADHÉRENT POUR SOUDAGE / WELDING SPLASH REMOVER  
ANTIADHESIVO PER SALDATURE / REMOVEDOR DE SALPICOS DE SOLDAGEM



- ES Puede ser utilizado en cualquier tipo de equipo de soldadura para prevenir la adhesión de las salpicaduras; aconsejable para soldadura autógena, electrónica y bajo gas inerte. Sin silicona, protege de la oxidación y de la corrosión.
- FR Préviend l'adhérence des scories et les dépôts de soudure sur les parties traitées; s'utilise pour le soudage autogène, électrique et sous gaz inerte. Sans silicone, protège contre l'oxydation et la corrosion.
- EN For use on all forms of welding equipment to prevent the adhesion of spatter; suitable for autogenous, electrical and inert gas weldings. Silicone free, protects from oxidation and corrosion.
- IT Evita l'adesione di scorie e gocce di saldatura su qualsiasi supporto. Idonea per saldature autogene, elettriche ed a base di gas inerti. Il prodotto non contiene silicone e protegge da ossidi e corrosioni.
- PT Pode ser usado em qualquer tipo de equipamento de soldagem para evitar a aderência de respingos; adequado para soldagem autogénio, eletrônica e sob gás inerte. Sem silicone, protege contra ferrugem e corrosão.

Ref				
1500 0011	300 ml	1	12	6,34

HIDROREPELENTE CONTRA LA HUMEDAD / PROTECTION HYDROFUGE POUR L'ÉQUIPEMENT ÉLECTRIQUE / WATER REPELLENT AGAINST HUMIDITY  
IDROREPELENTE ANTIUMIDITÀ / REPELENTE DE ÁGUA CONTRA A HUMIDADE



- ES Protección hidrorrepelente para equipos electrónicos. Previene cortes eléctricos debidos a la humedad o a la condensación; restablece la funcionalidad de motores eléctricos, bobinas y terminales expuestos a la humedad.
- FR Protection hydrofuge pour l'équipement électrique. Empêche la fuite électrique due à l'humidité ou à la condensation; rétablit la fonction des moteurs électriques, des bobines et des bornes électriques dans les endroits exposés à l'humidité.
- EN Water repellent protection for electric equipment. Prevents electric leakage due to damp or condensation; reinstates functionalities of electric engines, coils and terminals exposed to damp.
- IT Spray che garantisce una protezione idrorepellente e forma una barriera anti umidità. Evita dispersioni elettriche. È ideale per il ripristino della funzionalità di motori elettrici, bobine, morsetterie, quadri, calotte, batterie soggette ad esposizione in ambienti umidi.
- PT Proteção repelente de água para equipamentos eletrônicos. Evita os cortes de energia devido à umidade ou condensação; restaura a funcionalidade de motores elétricos, bobinas e terminais expostos à umidade.

Ref				
1500 0014	400 ml	1	12	6,55

QUITA GRAFFITI 400 ML / ELIMINE LES GRAFFITIS / GRAFFITI REMOVER / RIMUOVI GRAFFITI / REMOVEDOR DE GRAFFITI



- ES Elimina cualquier tipo de pintura de manera eficiente y profesional. Es un rápido decapante de pintura que puede ser aplicado en plásticos, metales, asfalto, piedra, madera y cristal. Aplicar sobre la superficie interesada y esperar pocos minutos para que el producto actúe. Repetir la operación si fuese necesario.
- FR Élimine tout type de peinture de manière efficace et professionnelle. C'est un décapant de peinture rapide pouvant être appliqué sur le plastique, les métaux, l'asphalte, la pierre, le bois, le cristal. Il faut l'appliquer sur la surface désignée et attendre quelques minutes pour que le produit agisse. Répéter l'opération si nécessaire.
- EN Removes paints of all kinds in an efficient and professional way. It's a quick paint remover that can be applied on plastics, metals, concrete, stone, wood, glass. Spray on surface of interest, wait a few minutes for the product to act. Repeat operation if necessary.
- IT Rimuove in maniera efficace e professionale vernici di tutti i tipi. È uno sverniciante che può essere utilizzato su plastiche, metalli, cemento, pietra, legno e vetro. Applicare sull'area di interesse e lasciare agire per alcuni minuti; ripetere l'operazione nel caso di vernici particolarmente resistenti.
- PT Elimina qualquer tipo de pintura de uma maneira eficiente e profissional. É um rápido removedor de tinta, que pode ser aplicado em metais, asfalto, pedra, madeira, vidro. Aplicar sobre a superfície em causa e aguardar alguns minutos para que o produto possa agir. Repita, se necessário.

Ref				
1500 0016	400 ml	1	12	10,19



ADHESIVO EN SPRAY 400 ML / ADHÉSIF EN SPRAY / ADHESIVE SPRAY / ADESIVO SPRAY / COLA ADHESIVA EN SPRAY



ES Producto de alta calidad. El spray permite pegar materiales como metales, plástico, madera, vidrio, papel, materiales expandidos, etc. Especial válvula de distribución para el correcto suministro del producto.

FR Produit de grande qualité, le spray permet de coller des matériaux comme les métaux, le plastique, le bois, le verre, le papier...etc. Valve de distribution pour verser correctement le produit.

EN High quality product, it allows you to stick materials such as metals, plastic, wood, glass, paper, expanded materials, etc. Special valve for the product's correct use.

IT Prodotto di alta qualità, lo spray permette di incollare materiali come metalli, plastica, legno, vetro, carta, materiali espansi, ecc. Valvola speciale di distribuzione per un corretto utilizzo del prodotto.

PT Produto de alta qualidade, o spray permite colar materiais como metal, plástico, madeira, vidro, papel, materiais expandidos, etc. Especial válvula de distribuição para o correcto suministro do produto.

Ref				
1500 0023	400 g	1	12	10,45

AIRE COMPRIMIDO EN SPRAY 400 ML / AIR COMPRIMÉ / COMPRESSED AIR / ARIA COMPRESSA / AIR, COMPRIMIDO



ES Ideal para limpiezas en zonas difíciles y áreas inaccesibles. Emite aire congelado invirtiendo el envase hacia abajo.

FR Idéal pour le nettoyage dans des zones d'iciles et inaccessibles. Emet de l'air froid en inversant la direction vers le bas.

EN Perfect for cleaning difficult and inaccessible areas. It emits frozen air by turning the container upside down.

IT Ideale per pulire in zone di difficile accesso. Fornisce aria congelata capovolgendo il contenitore verso il basso.

PT Ideal para a limpeza em zonas difíceis e inacessíveis. Lança ar congelado invertendo o recipiente para baixo.

Ref				
1500 1028	400 ml	1	6	9,47

PASACABLES EN SPRAY 400 ML / PASSE CABLES EN SPRAY / FAIRLEAD SPRAY / SPRAY PASSACAVI / GEL PASSA CABOS EM SPRAY



ES Un producto aerosol para cables eléctricos, telefónicos o de fibra óptica. Su fórmula no daña las cubiertas de plástico ni de goma, protege los cables del envejecimiento.

FR Un produit aérosol pour câbles électriques, téléphoniques ou fibre optique. Sa formule n'endommage pas les couvercles en plastique ou en caoutchouc, protège les câbles du vieillissement.

EN A spray product for electric wires, telephonic or optical fiber. Its composition does not damage the plastic or rubber covers, it protects the wires from aging.

IT Prodotto spray per cavi elettrici, telefonici o fibra ottica. La sua formula non danneggia i rivestimenti in plastica o in gomma, protegge i cavi dall'invecchiamento.

PT Um produto aerosol para cabos eléctricos, telefónicos ou de fibra óptica. A sua formula nao danifica as cubertas de plástico ou borracha, protege os cabos do envelhecimento.

Ref				
1500 0041	400 ml	1	12	8,69

ANTIDESLIZANTE EN SPRAY TRANSPARENTE / ANTIDÉRAPANT EN SPRAY / ANTI-SLIP SPRAY  
SPRAY ANTISCIVOLO / ANTI-DESLIZAMENTO EM SPRAY



ES Antideslizante en spray transparente ideal para el tratamiento de superficies resbaladizas como escaleras, bañeras y cualquier superficie resbaladiza ya sea de plástico, madera o metal.

FR Antidérapant en spray transparent idéal pour le traitement de surfaces glissantes comme les escaliers, baignoires et toute surface glissante en plastique, bois ou métal.

EN Transparent anti-slip spray ideal for the treatment of slippery surfaces such as stairs, bathtubs and any other kind of slippery surfaces made of plastic, wood or metal.

IT Spray antiscivolo trasparente, ideale per il trattamento di superfici scivolose quali scale, vasche da bagno o qualsiasi altra superficie in plastica, legno o metallo.

PT Antiderrapante em spray transparente, ideal para o tratamento de superficies escorregadias, tais como escadas, banheiras e qualquer superfície escorregadia seja de plástico, madeira ou metal.

Ref				
1500 0066	400 ml	1	6	10,52

QUITAMANCHAS EN SECO PARA TEJIDOS / DÉTACHANTS A SEC POUR TISSUS / DRY CLEANING FOR FABRICS  
SMACCHIATORE A SECCO PER TESSUTI / TIRA NÓDOAS A SECO PARA TECIDOS



ES Quitamanchas en seco para tejidos. Especial para remover manchas de grasa y aceites en cualquier tipo de tejido, tapicerías, sedas, etc.

FR Détachants à sec pour tissus, enleve les taches de graisses et d'huiles sur tout type de tissus, tapisseries, soies, etc.

EN Dry cleaning for fabrics used specially for removing grease and oil stains in any type of fabric, upholstery, silk, etc.

IT Smacchiatore a secco per tessuti speciali. Indicato per la rimozione di macchi di grasso e olio su qualsiasi tipo di tessuto, tappezzeria, seta, ecc.

PT Tira nódoas em seco para tecidos, especial para remover manchas de gorduras e óleos em qualquer tecido, estofos, seda, etc.

Ref				
1500 0065	200 ml	1	6	8,46



AVISADOR ACÚSTICO COMPLETO / AVERTISSEUR ACOUSTIQUE COMPLET / ACOUSTIC GAS HORN (COMPLETE KIT)  
RILEVATORE ACUSTICO COMPLETO / AVISADOR SONORO COMPLETO



ES Avisador acústico con recambio, ideal para eventos deportivos o señalizaciones acústicas.  
FR Klaxon avec recharge, idéal pour les événements sportifs ou signalisations acoustiques.  
EN Air horn with refill, ideal for sporting events or acoustic signalling.  
IT Tromba a gas con ricambio, adatto per eventi sportivi o segnalazione acustica.  
PT Sinalizador acústico com recarga, ideal para eventos desportivos ou sinalizações acústicas.

Ref				
1500 0077	300 ml	1	6	12,67

RECARGA AVISADOR ACÚSTICO / RECHARGE AVERTISSEUR ACOUSTIQUE / ACOUSTIC GAS HORN REFILL  
RICARICA RILEVATORE ACUSTICO / RECARGA AVISADOR SONORO



Ref				
1500 0078	300 ml	1	6	6,11

DESATASCADOR LÍQUIDO CONCENTRADO / DEBOUCHEUR CONCENTRÉ LIQUIDE / CONCENTRATED LIQUID PLUNGER  
DISGORGANTE DETERGENTE CONCENTRATO / DESENTUPIDOR LIQUIDO CONCENTRADO



ES DESATASCADOR CONCENTRADO DE TUBERÍAS Y DESAGÜES. Producto concentrado para atascos de cualquier materia. Previene los atranques y elimina los malos olores. MODO DE EMPLEO: Aplicar directamente en la tubería o sumidero y esperar 30 minutos aproximadamente, si el atasco persiste, repetir la operación nuevamente.  
FR DEBOUCHEUR LIQUIDE CONCENTRÉ TUYAUTERIES ET EGOUTS. Produit concentré pour déboucher. Il empeche les obstacles et elimines les mauvaises odeurs. Mode d'emploi: Appliquer directement dans les tuyaux ou les egouts et attendre 30 minutes environ si l'obstacle persiste, répéter l'opération.  
EN CONCENTRATED LIQUID PLUNGER FOR PIPES AND SEWERS. Concentrated products for different materials clogs. it prevents the clogs and eliminate unpleasant odours. Instructions: apply directly into the pipe and wait 30 minutes approx., if the clog persists, repeat the procedure.  
IT DISGORGANTE CONCENTRATO PER TUBI E SCARICHI. Disgorgante concentrato per la rimozione di qualsiasi materiale. previene il blocco ed elimina i cattivi odori. Istruzioni di utilizzo: applicare direttamente nel tubo o scarico e attendere circa 30 minuti, se l'inzeppamento persiste, ripetere nuovamente l'operazione.  
PT DESENTUPIDOR LIQUIDO CONCENTRADO DE TUBOS E ESGOTOS. Produto concentrado para obstruções de qualquer matéria. prevém as obstruções e elimina os maus cheiros. Modo de usar: aplicar diretamente no cano ou dreno e esperar aproximadamente 30 minutos, se persistir a obstrução, repetir a operação outra vez.

98%  
Ácido sulfúrico / Sulfuric Acid

Ref				
1500 0045	1000 ml		12	7,92

APAGA LLAMAS / EXTINCTEUR / FIRE EXTINGUISHER SPRAY / SPEGNIFIAMMA / EXTINTOR SPRAY



ES El producto es apropiado para apagar pequeños focos. Su empleo, además, limita el área involucrada evitando que el fuego se expanda. Orientar el chorro del producto a la base de las llamas; no utilizar en instalaciones eléctricas o sistemas sujetos a tensión.  
FR Produit idéal pour éteindre des petits foyers de feu. Son utilisation limite en outre la zone concernée, évitant la propagation du feu. Orienter le jet à la base des flammes ; ne pas utiliser dans des zones ou sur des systèmes électriques.  
EN The product is particularly suitable to extinguish flames and small fires. It may also be used to limit and keep under control flames within the area of interest. Spray at the base of the flames; do not use on electric systems or on applications subject to tension.  
IT Il prodotto è particolarmente adatto allo spegnimento di focolai. Il suo utilizzo, inoltre, circoscrive l'area interessata evitando l'espandersi del fuoco. Orientare il getto del prodotto alla base delle fiamme; non utilizzare su impianti elettrici o sistemi soggetti a tensione.  
PT O produto é particularmente adequado para extinguir as chamas e pequenos incêndios. Também pode ser usado para limitar e manter sob controlo as chamas na área em causa evitando que o fogo se expanda. Borrife na base das chamas, não utilizar em sistemas elétricos ou em aplicações sujeitas a tensão.

Ref				
1500 0015	300 ml	1	12	11,34



GEL HIDROALCOHÓLICO / GEL HYDROALCOOLIQUE / HAND SATINISER GEL / GEL IGIENIZZANTE / GEL HIDROALCOHÓLICO



5 L



500 ML



100 ML

ES Indicado para la completa limpieza de las manos sin utilizar agua, pudiéndose usar en cualquier situación o lugar. Modo de empleo: Vierta una cantidad de producto directamente sobre la mano y extiéndalo sobre la piel hasta su completa absorción.

FR Indiqué pour le nettoyage complet des mains sans utiliser d'eau, pouvant être utilisé dans n'importe quelle situation ou lieu. Mode d'emploi: Verser une quantité de produit directement sur la main et étaler le produit sur la peau jusqu'à absorption complète.

EN This hydroalcoholic gel is intended for a thorough cleaning. It could be used in places where soap and water are not available. Directions: Apply a small quantity of this hand sanitiser to the palm of one hand and rub hands together covering all hands and fingers until dry.

IT Indicato per avere mani pulite e igienizzate anche quando si è fuori casa. Si utilizza senza acqua. Istruzioni d'uso: applicare sul palmo della mano una piccola quantità e sgraffinare fino a completa asciugatura.

PT Indicado para uma limpeza completa das mãos sem utilizar água, podendo ser usado em qualquer situação ou lugar. Modo de emprego: verta uma quantidade de produto diretamente sobre as mãos e extenda o produto sobre a pele até a sua completas absorção.

ES Olor: perfumado. pH: 6 ± 1. Densidad: 0,865 g/ml ± 0,05 a 25 °C. Contenido en alcoholes: 70 % mezcla de alcohol etílico/alcohol isopropílico.

FR Odeur: parfumée. pH: 6 ± 1. Densité: 0,865 g / ml ± 0,05 à 25 °C. Teneur en alcool: 70% de mélange alcool éthylique / alcool isopropylique.

EN Fragranced. pH: 6 ± 1. Density: 0,865 g/ml ± 0,05 at 25 °C. Alcohol content: 70% of ethanol and isopropanol.

IT Profumato. pH: 6 ± 1. Densità: 0,865 g/ml ± 0,05 a 25 °C. Ingredienti: 70% miscela di etanol e alcool isopropilico.

PT Odor: perfumado. pH: 6 ± 1. Densidade: 0,865 g/ml ± 0,05 a 25 °C. Contéudo em álcool : 70% mistura de álcool etílico/ álcool isopropílico.

Ref				
<b>1500 0084</b>	5 L	1	2	<b>64,15</b>
<b>1500 0088</b>	500 ML	12	12	<b>8,52</b>
<b>1500 0089</b>	100 ML	35	35	<b>2,75</b>

DOSIFICADOR / DISTRIBUTEUR / DISPENSER / DOSATORE / DOSIFICADOR



5 L



500 ML

ES Dosificadores de líquidos para recipientes de gel hidroalcohólico con capacidad de 500 ml y de 5 litros que permiten dosificar y servir la cantidad de producto adecuada sin tener pérdidas.

FR Distributeurs de liquide pour récipients de 500ml et 5 litres de gel hydroalcooolique qui permet de distribuer et de servir la bonne quantité du produit sans perte.

EN This pumps dispenser are intended for containers with a capacity of 500 millilitres and 5 litres. They dispense the accurate quantity per pome without any leakage.

IT I dosatori a pompa per contenitori da 500 millilitri e 5 litri facilita il dosaggio con la quantità adeguata di gel igienizzante, nessuna perdita del liquido.

PT Dosificadores de líquidos para recipientes de gel hidroalcooolico com capacidade de 500ml e de 5litros que permitem dosificar e servir a quantidade adequada do produto sem ter perdas.

Ref			
<b>1500 0085</b>	5 L	1	<b>8,90</b>
<b>1500 0088.01</b>	500 ML	1	<b>1,09</b>

TOALLITAS PARA LIMPIEZA DE MANOS ANTIBACTERIAS / LINGETTES MAINS ANTIBACTERIENNES / HAND WET WIPES WITH ANTIBACTERIAL EFFECT / SALVIETTINE DETERGENTI PER MANI CON ANTIBATTERICO / TOALHITAS DE LIMPEZA ANTIBACTERIANAS PARA AS MÃOS



ES Toallitas de limpieza humedecidas con el lado abrasivo, alto poder limpiador y desengrasante con extracto de Aloe Vera.

FR Lingettes de nettoyage humidifiées pour le côté abrasif, pour nettoyer et dégraisser avec un extrait d'Aloe Vera.

EN Hand wipes moistened by the abrasive side, high degreasing and cleaning power, with Aloe Vera extract.

IT Salviettine detergenti inumidite con lato abrasivo, alto potere pulente e sgrassante con estratto di Aloe Vera.

PT Toalhitas de limpeza humedecidas pelo lado abrasivo, alto poder de limpeza e desengordurante com extrato de Aloe Vera.

Ref				
<b>1500 0081</b>	40 pcs	1	6	<b>18,98</b>
<b>1500 0082</b>	100 pcs	1	4	<b>49,20</b>





CEMENTO RÁPIDO / CIMENT RAPIDE / QUICK-SETTING CEMENT / CEMENTO RAPIDO / CIMENTO RÁPIDO



- ES Reparaciones de paredes y suelos. Cemento de secado rápido, para reparaciones de paredes y suelos en espacios interiores y exteriores. Utilizado en la instalación de portones, tapas de alcantarillado, piedras de fachadas, entre otros.
- FR Réparations des murs et des sols. Ciment de séchage rapide, pour des réparations de murs et de sols dans des espaces intérieurs et extérieurs. Utilisé pour l'installation de grandes portes, de bouches d'égouts, de pierres de façades, entre autres.
- EN Repairs walls and floors. Quick drying cement for repairing indoor and outdoor walls and floors. Used to install large doors, sewer covers, facade stones, among others.
- IT Riparazione di pareti e pavimenti. Cemento ad asciugatura rapida, adatto alla riparazione di pareti e pavimenti in ambienti interni ed esterni. Utilizzato in installazione di porte, tombini, facciate in pietra, e molto altro.
- PT Reparação de paredes e pisos. Cimento de secagem rápida para reparar paredes e pisos em espaços interiores e exteriores. Utilizado na instalação de portas, tampas de esgoto, fachadas de pedra, entre outros.

Ref				
1580 1051	850 g	1	6	3,90

YESO ESTUCAR / PLÂTRE A ENDUIRE / STUCCO PLASTER / INTONACO / GESSO PARA ESTUQUE



- ES Paredes y techos interiores. Yeso de aplicación manual indicado para estucar paredes y techos interiores por métodos tradicionales.
- FR Parois et plafonds intérieurs. Plâtre d'application manuelle indiqué pour colmater les murs et les plafonds intérieurs avec la méthode traditionnelle.
- EN Interior walls and ceilings. Plaster for manual application, suitable for stuccoing interior walls and ceilings by means of traditional methods.
- IT Pareti e soffitti interni. Gesso da applicare manualmente, indicato per stuccare pareti e tetti interni.
- PT Paredes e tetos interiores. Gesso de aplicação manual indicado para estucar paredes e tetos interiores por métodos tradicionais.

Ref				
1580 1061	750 g	1	6	3,67

COLA TRAMPA ADHESIVA ROEDORES / COLLE PIÈGE RONGEURS / ADHESIVE GLUE RODENT TRAP  
TRAPPOLA ADESIVA PER RODITORI / COLA DE ARMADILHA ADESIVA ROEDORES



Junto al cubo de basura  
Loger à côté de la poubelle  
Beside the rubbish bin  
Vicino alla pattumiera  
Ao lado do caixote de lixo



ES La cola trampa adhesiva roedores, es un efectivo sistema no venenoso para exterminar roedores e insectos (lagartos, cucarachas, hormigas, etc.). Estas trampas pegajosas atraen y atrapan a estos animales. **APLICACIÓN:** Está indicado para aplicar sobre cartones o placas plásticas para atrapar todo tipo de roedores. Si se añade un cebo (queso, cereales, migas de pan, etc.) son más efectivas. **PRECAUCIONES:** Mantener fuera del alcance de los niños. El pegamento se puede quitar de las manos y tejidos con aceite de cocina o jabón.

FR La colle piège rongeurs, est un système non toxique effectif pour exterminer les rongeurs et les insectes (lézards, cafards, fourmis, etc.). Ces pièges visqueux attirent et attrapent ces animaux. **APPLICATION:** Indiqué pour appliquer sur les cartons ou les plaques plastiques pour attraper tout type de rongeurs. Si on ajoute un appât (fromage, céréales, miettes de pain, etc.) le piège sera plus effectif. **PRÉCAUTIONS:** Tenir hors de portée des enfants. La colle peut être enlevée des mains et des tissus avec de l'huile de cuisine ou du savon.

EN The adhesive glue rodent trap is an effective and nonpoisonous system to exterminate rodents and insects (lizards, cockroaches, ants, etc.). These animals are attracted and trapped by these sticky traps. **APPLICATION:** Can be used on cardboard or plastic plates to trap any kind of rodent. By using a bait (cheese, cereals, crumbs, etc.) the trap will be more effective. **CAUTION:** Keep out of reach of children. Glue can be removed from hands and fabric with some cooking oil or some soap.

IT La colla adesiva per roditori è un efficace sistema non tossico per sterminare roditori e insetti (lucertole, scarafaggi, formiche, ecc.). Queste trappole adesive attirano e bloccano questi animali. **APPLICAZIONE:** Indicato per l'applicazione su cartoni o placche plastiche per catturare tutti i tipi di roditori. Aggiungendo un'esca (formaggio, cereali, pangrattato, ecc.) la trappola è più efficace. **PRECAUZIONI:** Tenere fuori dalla portata dei bambini. La colla può essere rimossa dalle mani e dai tessuti tramite olio da cucina o sapone.

PT A cola armadilha adesiva roedores é um sistema efetivo não venenoso para exterminar roedores e insetos (lagartos, baratas, formigas, etc.). Estas armadilhas pegajosas atraem e prendem estes animais. **APLICAÇÃO:** É apropriado para aplicação em cartão ou placas plásticas para apanhar todos os tipos de roedores. Se for adicionada uma isca (queijo, cereais, migalhas de pão, etc.) é mais eficaz. **PRECAUÇÕES:** Manter fora do alcance das crianças. A cola pode ser removida das mãos e tecidos com sabão ou óleo de cozinha.



Debajo del fregadero  
Sous l'évier  
Under the kitchen sink  
Sotto il lavandino  
Debaixo da pia



Cerca de tuberías  
Près de tuyaux  
Close to pipes  
Vicino ai tubi  
Junto aos tubos



En la despensa  
Dans le cellier  
In the larder  
Nella dispensa  
Na despensa

Ref				
1500 0061	135 g	1	6	3,32



PINTURA EN SPRAY / LAQUE ACRYLIQUE SPRAY / ACRYLIC SPRAY PAINT / VERNICE ACRILICA / PINTURA EM SPRAY



ES Pintura acrílica en spray. Esmalte acrílico 100%. Ideal para superficies metálicas como hierro, bronce, aluminio, materiales plásticos, albañilería, madera y cemento. Para uso en interiores y exteriores, de secado rápido.

FR Laque acrylique spray. Laque acrylique pour un usage professionnel, possède des excellentes propriétés adhésives. Produit idéal pour peindre les surfaces en métal – comme fer, laiton, aluminium – et les matériaux en plastique. Séchage rapide.

EN Acrylic spray paint. Acrylic enamel for professional use with excellent adhesive properties. Ideal for painting operations of metal surfaces - such as iron, brass, aluminium – and plastic materials. Quick drying.

IT Vernice acrilica. Smalto acrilico ad uso professionale ad alta adesività. Ideale per le operazioni di pittura/verniciatura di superfici metalliche – quali ferro, bronzo ed alluminio – e materiali plastici. Di rapida essiccazione.

PT Tinta em spray. Pintura de Esmalte 100% acrílico en spray. Cores por numeração RAL, ideal para superficies metálicas, como ferro, bronce, alumínio, plásticos, materiais de construção, madeira e cimento. Para uso interno e externo, de secagem rápida.

Ref			RAL					
1500 1001		Negro brillo / Noir foncé / Jet black / Nero intenso / Preto brilhante	9005	400 ml	1	6		<b>7,09</b>
1500 1002		Negro mate / Noir mat / Matt black / Nero opaco / Preto mate	9005	400 ml	1	6		<b>7,09</b>
1500 1033		Negro satinado / Noir satine / Glossy black / Nero intenso / Preto acetinado	9005	400 ml	1	6		<b>7,09</b>
1500 1003		Blanco brillo / Blanc brillant / Shiny white Bianco intenso / Branco brilhante	9010	400 ml	1	6		<b>7,09</b>
1500 1004		Blanco mate / Blanc mat / Matt white / Bianco opaco / Branco mate	9010	400 ml	1	6		<b>7,09</b>
1500 1005		Electrodomésticos / Électroménager / Electrical appliance / Elettrodomestico / Eletrodoméstico	9010	400 ml	1	6		<b>7,09</b>
1500 1006		Blanco tráfico / Blanc signalisation / Traffic white Bianco traffico / Branco tráfego	9016	400 ml	1	6		<b>7,09</b>
1500 1030		Blanco satinado / Blanc satine / Glossy white / Bianco puro / Branco acetinado	9010	400 ml	1	6		<b>7,09</b>
1500 1035		Marfil claro / Ivoire clair / Light ivory / Avorio chiaro / Marfim claro	1015	400 ml	1	6		<b>7,09</b>
1500 1047		Amarillo / Jaune / Yellow Giallo zinco / Amarelo zinc	<b>ADAPT. JOHN DEERE</b>	1018	400 ml	1	6	<b>7,09</b>
1500 1007		Amarillo tráfico / Jaune signalisation / Traffic yellow Giallo traffico / Branco tráfego	1023	400 ml	1	6		<b>7,09</b>
1500 1034		Amarillo narciso / Jaune narcisses / Daffodil yellow Giallo narciso / Amarelo narciso	1007	400 ml	1	6		<b>7,09</b>
1500 1050		Amarillo señales / Jaune de securite / Signal yellow Giallo segnale / Branco sinais	1003	400 ml	1	6		<b>7,09</b>
1500 1036		Naranja puro / Orange pur / Pure orange / Arancio puro / Laranja puro	2004	400 ml	1	6		<b>7,09</b>
1500 1009		Rojo tráfico / Rojo tráfico / Traffic red / Rosso traffico / Vermelho tráfego	3020	400 ml	1	6		<b>7,09</b>
1500 1008		Rojo fuego / Rouge feu / Flame red Rosso fuoco / Vermelho fogo	<b>ADAPT. KVERNELAND</b>	3000	400 ml	1	6	<b>7,09</b>
1500 1037		Rojo vino / Vin rouge / Wine red / Rosso vino / Vermelho vinho	3005	400 ml	1	6		<b>7,09</b>
1500 1016		Marrón sepia / Marron sepia / Sepia brown Marrone seppia / Castanho sépia	8014	400 ml	1	6		<b>7,09</b>
1500 1044		Marrón señales / Marron signal / Signal brown Marrone segnale / Castanho sinais	8002	400 ml	1	6		<b>7,09</b>
1500 1045		Marrón chocolate / Marron chocolat / Chocolat brown Marrone cioccolata / Castanho chocolate	8017	400 ml	1	6		<b>7,09</b>
1500 1051		Violeta érica / Violet buyere / Heather violet Viola erica / Violeta érica	4003	400 ml	1	6		<b>7,09</b>
1500 1053		Violeta señales / Violet de securite / Signal violet Violetto segnale / Violeta sinais	4008	400 ml	1	6		<b>7,09</b>
1500 1052		Lila azulado / Lilas bleuté / Blue lilac Lilla bluastró / Lilás azulado	4005	400 ml	1	6		<b>7,09</b>
1500 1054		Magenta tele / / Tele magenta / Telemagenta Tele magenta / Magenta tele	4010	400 ml	1	6		<b>7,09</b>
1500 1021		Azul luminoso / Bleu lumineux / Luminous blue Azzurro luminoso / Azul Luminoso	5012	400 ml	1	6		<b>7,09</b>
1500 1039		Azul celeste / Bleu ciel / Sky blue / Blu cielo / Azul celeste	5015	400 ml	1	6		<b>7,09</b>
1500 1038		Azul señales / Bleu signal / Signal blue / Blu segnale / Azul sinais	5005	400 ml	1	6		<b>7,09</b>
1500 1010		Azul genciana / Azul genciana / Gentian blue Blu genziana / Azul genciana	<b>ADAPT. NEW HOLLAND</b>	5010	400 ml	1	6	<b>7,09</b>



PINTURA EN SPRAY / LAQUE ACRYLIQUE SPRAY / ACRYLIC SPRAY PAINT / VERNICE ACRILICA / PINTURA EM SPRAY

Ref			RAL				
1500 1041		Verde amarillento / Vert anis / Yellow green Verde giallastro / Verde amarelado	6018	400 ml	1	6	<b>7,09</b>
1500 1040		Verde hoja / Feuilles vertes / Leaf green / Verde foglia / Verde folha	6002	400 ml	1	6	<b>7,09</b>
1500 1011		Verde musgo / Vert mousse / Moss green Verde muschio / Verde musgo	6005	400 ml	1	6	<b>7,09</b>
1500 1012		Verde abeto / Vert sapin / Fir green / Verde abete / Verde abeto	6009	400 ml	1	6	<b>7,09</b>
1500 1048		Verde / Vert / Green Verde / Verde	6001	400 ml	1	6	<b>7,09</b>
1500 1043		Gris luminoso / Gris lumineux / Light grey / Grigio luce / Cinza luminoso	7035	400 ml	1	6	<b>7,09</b>
1500 1015		Aluminio blanco / Aluminium blanc / White aluminium Aluminio brillante / Alumínio	9006	400 ml	1	6	<b>7,09</b>
1500 1013		Gris plata / Gris argent / Silver grey / Grigio argento / Cinza prata	7001	400 ml	1	6	<b>7,09</b>
1500 1042		Gris antracita / Gris anthracite / Anthracite grey Grigio antracite / Cinza antracite	7016	400 ml	1	6	<b>7,09</b>
1500 1014		Gris hierro / Gris fer / Iron grey / Grigio ferro / Cinza ferro	7011	400 ml	1	6	<b>7,09</b>
1500 1060		Aluminio llantas / Jantes aluminium / Alluminium rims Aluminio Brillante / Aluminio jantes	9006	400 ml	1	6	<b>7,09</b>
1500 1061		Gris aluminio / Gris aluminium / Grey alluminium Alluminio grigiastro / Cinza aluminio	9007	400 ml	1	6	<b>7,09</b>
1500 1057		Plata / Argent / Silver / Argento / Prata	-	400 ml	1	6	<b>9,60</b>
1500 1055		Oro pálido / Or pâle / Pale gold Oro pallido / Ouro pálido	-	400 ml	1	6	<b>9,60</b>
1500 1056		Oro rico / Or brillant / Rich gold Oro ricco / Ouro rico	-	400 ml	1	6	<b>9,60</b>
1500 1058		Bronce / Bronze / Bronze / Bronzo / Bronze	-	400 ml	1	6	<b>9,60</b>
1500 1059		Cobre / Cuivre / Copper / Rame / Cobre	-	400 ml	1	6	<b>9,60</b>

CARTA COLORES RAL PINTURA ACRÍLICA SPRAY / CARTE DE COULEURS RAL PEINTURE ACRYLIQUE SPRAY / RAL COLOUR CHART ACRYLIC SPRAY PAINT  
SCHEDE COLORI RAL VERNICE ACRILICA SPRAY / CARTA DE CORES RAL TINTA ACRÍLICA SPRAY



Ref		
1500 9996	1	<b>4,50</b>

PELÍCULA REMOVIBLE PROTECCIÓN LLANTAS / FILM AMOVIBLE PROTECTION JANTE / REMOVABLE PROTECTIVE FILM FOR RIMS  
PELLICOLA PROTETTIVA RIMOVIBILE CERCHI / PELÍCULA REMOVÍVEL PROTEÇÃO JANTES



Ref						
1500 0067		Negro mate / Noir mat / Matt black Nero opaco / Preto mate	400 ml	1	6	<b>18,30</b>
1500 0072		Blanco brillo / Blanc brillant / Shiny white Bianco intenso / Branco brilhante	400 ml	1	6	<b>17,60</b>
1500 0073		Aluminio / Aluminium / Aluminium Aluminio / Alumínio	400 ml	1	6	<b>17,60</b>



PISTOLA PARA SPRAY UNIVERSAL / PISTOLET UNIVERSEL POUR SPRAY / UNIVERSAL SPRAY GUN  
PISTOLA UNIVERSALE PER BOMBOLETTE SPRAY / PISTOLA DE PINTURA PARA LATAS DE SPRAY



Ref			
1500 1025	1	6	10,35

PINTURA ACRÍLICA EFECTO CROMO / SPRAY ACRYLIQUE EFFET CHROME / CHROME EFFECT ACRYLIC SPRAY  
SPRAY ACRILICO EFFETTO CROMATO / PINTURA EFEITO CROMADO



ES Spray acrílico para uso profesional y para todas las aplicaciones de bricolaje. Ideal para labores de retoque. Disponible en color cromo, plata y cromo oro.

FR Spray acrylique pour utilisation professionnelle et pour toutes les applications de bricolage. Idéal pour des tâches de retouche. Disponible en couleur Chrome, d'argent et Chrome Or.

EN Acrylic spray for professional use and for all the DIY applications. Ideal for retouch work. Available in silver Chrome and Gold Chrome.

IT Vernice spray acrilica ad uso professionale ed hobbistico. Ideale per lavori di ritocco. Disponibile nei colori Cromo argento e Cromo Oro.

PT Pintura de efeito cromado cor Ouro e Prata. Ideal para trabalhos de retoque de aplicações profissionais e bricolage.

Ref						
1500 1019		Plata / D'argent / Silver Argento / Prata	400 ml	1	6	10,27
1500 1020		Oro / Or / Gold / Oro / Ouro	400 ml	1	6	10,27

PINTURA EFECTO FORJA / PEINTURE EFFET FORGE / IRON EFFECT PAINTING  
VERNICE SPRAY, EFFETTO FERRO ANTICO / PINTURA EFEITO FORJA



ES Pintura para decorar y proteger superficies metálicas. Acabado grueso y duro que produce un efecto de hierro antiguo. Resistente a la abrasión. Excelente durabilidad a la intemperie. Disponible en color negro o gris.

FR Peinture pour décorer et protéger des superficies métalliques. Produit un effet de fer vieilli durable. Résistant à l'abrasion. Excellente résistance aux intempéries. Disponible en couleur noire ou grise.

EN Painting for decoration and protection of metallic surfaces. Rough and hard finishing that has an effect of old iron. Abrasive resistant. Excellent durability for exterior use. Available in black and grey.

IT Vernice spray per la decorazione e protezione di superfici metalliche. Finitura ad alto spessore con effetto tipico del ferro antico. Resistente alle abrasioni ed agli agenti atmosferici; ottima durabilità in esterno. Disponibile in colore nero e grigio.

PT Pintura de efeito forja para descolorar e proteger superficies metálicas, produz um efeito de cor de ferro antigo resistente à abrasão. Disponível em preto e cinza escuro.

Ref						
1500 1022		Negro / Noir / Black / Nero / Preto	400 ml	1	6	8,90
1500 1023		Gris / Gris / Grey / Grigio / Cinza	400 ml	1	6	8,90

CUBREMANCHAS PARA PARED COLOR BLANCO / APPRET RECOUVRE TACHE POUR LES MURS COULEUR BLANCHE  
STAIN COVERING PAINT FOR WALLS - WHITE COLOUR / COPRIMACCHIA PER PARETI / TINTA COBRE MANCHAS PARA PAREDE COR BRANCA



ES Fórmula de alta capacidad de cubrición que después de una sola mano elimina totalmente cualquier mancha, penetrando en la superficie e implicando la formación de nuevas manchas.

FR Formule de haute capacité de couvrance qui d'une seule main élimine toutes les taches, pénétrant dans la surface et en évitant la formation de nouvelles taches.

EN With a formula for a high covering capacity that completely removes any stain with just a coat of paint by penetrating into the surface and preventing the formation of new stains.

IT Con formula d'ottima copertura che rimuove completamente ogni macchia penetrando sulla superficie e prevenendo la formazione di nuove macchie.

PT Fórmula de alta capacidade de cobertura que, após uma mão, elimina totalmente qualquer mancha, penetrando na superfície e envolvendo a formação de novos pontos.

Ref						
1500 0074		Blanco / Blanc / White / Bianco / Branco	400 ml	1	6	8,19





IMPRIMACIÓN GRIS ANTIÓXIDO / ANTIOXYDANT GRIS / ANTI-RUST GREY / ANTIOSSIDANTE GRIGIO / PRIMÁRIO ANTIOXIDANTE CINZA



ES Imprimación antióxido de color gris. Se aconseja utilizar como base antes de pintar cualquier pieza.  
FR Impression antioxydant de couleur grise. Nous conseillons de l'utiliser comme base avant de peindre chaque pièce.  
EN Anti-rust bath of grey color. It is recommended to use it before any part painting.  
IT Vernice spray antiruggine di colore grigio. Se ne consiglia l'utilizzo come base aggrappante prima della verniciatura di qualsiasi pezzo.  
PT Primário em spray antioxidante de cor cinza, ideal para ser utilizado como base antes de pintar qualquer peça.

Ref				
1500 1024	400 ml	1	6	7,81

INOX SPRAY / PULVERISATEUR INOX / STAINLESS STEEL SPRAY / SPRAY INOX / INOX SPRAY



ES INOX spray. Capa protectora a base de acero inoxidable, apropiada para todos los metales. Resistente al agua y a la sal. Proporciona protección contra los agentes atmosféricos y la corrosión.  
FR Pulverisateur INOX. Revêtement protecteur à base d'acier inox, s'utilise sur tous les métaux. Possède une grande résistance au sel et à l'eau. Peut être laqué et résiste aux agents atmosphériques et à la corrosion.  
EN Stainless steel spray. Stainless steel protective coating suitable for all metals. Product highly resistant to water and salt. Can be overpainted and provides protection against atmospheric agents and corrosion.  
IT Spray INOX. Rivestimento protettivo a base di acciaio INOX, idoneo per tutti i tipi di metallo. Alta resistenza all'acqua ed al sale. Resiste agli agenti atmosferici ed alla corrosione. Può essere sovraverniciato.  
PT INOX spray. Protetor de AÇO INOX em spray. Camada protectora á base de aço inoxidável, adequado para todos os metais. Resistente à água e sal. Oferece proteção contra as intempéries e à corrosão.

Ref				
1500 0009	400 ml	1	12	7,85

GALVANIZADO EN FRÍO / BRILLANT POUR ZINC / BRIGHT ZINC / ZINCO CHIARO / GALVANIZAÇÃO A FRIO



ES Galvanizado en frío. Aerosol para galvanizar en frío particularmente recomendable para recubrimientos metálicos. Resistente al aceite y a la grasa. Seca rápidamente.  
FR Brillant pour zinc. Vaporisateur à froid, s'utilise particulièrement pour le revêtement des parties en métal; offre une protection pour les parties soudées du metal, résiste aux graisses et aux huiles. Séchage rapide.  
EN Bright zinc. Cold galvanizing spray particularly suitable for metals coating; a protective agent for welded parts, it's grease and oil resistant. Quick drying.  
IT Zinco Chiaro. Spray zincante a freddo, particolarmente adatto per il ritocco di parti zincate. E' un protettivo per parti saldate ed è resistente ai grassi ed agli oli. Asciuga rapidamente.  
PT Galvanização a frio. Spray frio para galvanização, particularmente adequado para revestimentos metálicos. Resistente a óleo e a gordura. Seca rapidamente.

Ref				
1500 0008	400 ml	1	12	6,93

PINTURA REFLEXIVA / PEINTURE RÉFLÉCHISSANTE / REFLECTIVE PAINT / VERNICE CATARIFRANGENTE / TINTA ACRÍLICA REFLEXIVA



ES Reflectante acrílico con microesferas de vidrio. Cualquier elemento pintado con este spray al recibir un haz de luz lo reflejará, volviéndose muy visible en la oscuridad. Si se aplica sobre la ropa, el barniz puede quitarse lavándola con agua caliente.  
FR Peinture réfléchissante acrylique contenant des microbilles de verre. Tous les éléments peints avec la peinture réfléchissante s'ils sont réfléchis par une source de lumière, deviennent clairement visible dans l'obscurité. Si elle est appliquée sur les vêtements, la peinture peut être enlevée en lavant à l'eau chaude.  
EN Acrylic reflective paint which contains glass microspheres. Any element painted with this spray, if hit by a beam of light, it will be reflected, making it clearly visible in the darkness. If applied on garments, the paint can be removed by washing it with hot water.  
IT Vernice acrilica catarifrangente contenente microsfere di vetro. Un qualsiasi elemento verniciato con verniciato con vernice catarifrangente se colpito da un fascio di luce lo rifletterà, rendendosi visibile chiaramente al buio. Se applicato su indumenti, la vernice può essere rimossa con lavaggio in acqua calda.  
PT Tinta acrílica reflexiva contendo microesferas de vidro. Um elemento qualquer pintado com tinta reflexiva, se for atingido por um feixe de luz, o refletirá, tornando-se visível claramente no escuro. Se aplicada sobre a roupa, a tinta pode ser removida com lavagem em água quente.

Ref				
1500 0083	400 ml	1	12	19,66

MARCADOR SPRAY FLUORESCENTE / TRAÇEUR DE CHANTIER FLUORESCENT / FLUORESCENT MARKING SPRAY  
MARCATORE DA CANTIERE FLUORESCENTE / MARCADORES DE PINTURA FLUORESCENTE

360°



Ref					
1500 2001		500 ml	1	12	8,35
1500 2002		500 ml	1	12	8,35
1500 2003		500 ml	1	12	8,35
1500 2004		500 ml	1	12	8,35





PINTURA ANTICALÓRICA / PEINTURE HAUTE TEMPERATURE / HIGH TEMPERATURE SPRAY PAINT  
VERNICE ALTA TEMPERATURA / PINTURA RESISTENTE AO CALOR



ES Pintura para soportes expuestos a altas temperaturas. Resistente a temperaturas hasta 600°C. Ideal para tubos de escape, calderas, estufas. Disponible en negro y aluminio.

FR Peinture pour supports exposés à de hautes températures. Résistant à des températures jusqu'à 600°C. Idéal pour tuyaux d'échappement, chaudières, fourneaux. Disponible dans noir et aluminium.

EN Painting for supports exposed to high temperatures. Resistant to the temperatures till 600°C. Ideal for leak tubes, boilers, heaters. Available in black and aluminium color.

IT Vernice spray per supporti esposti ad alte temperature. Resistente sino a 600°C. Ideale per marmitte, caloriferi, stufe. Disponibile in nero ad alluminio.

PT Pintura resistente ao calor ideal para soportes expostos a altas temperaturas, resistentes até temperaturas de 600°C. Ideal para tubos de escape, estufas, caldeiras.

Ref						
1500 1017	■	Negro / Noir / Black / Nero / Preto	400 ml	1	6	9,35
1500 1018	■	Gris / Gris / Grey / Grigio / Cinza	400 ml	1	6	9,35

BARNIZ TRANSPARENTE 400 ML / VERNIS TRANSPARENT BRILLANTT / CLEAR GLOSS VARNISH  
VERNICE TRASPARENTE / VERNIZ TRANSPARENTE BRILHANTE



ES Excelente para aplicaciones en cualquier tipo de superficie, protegiendo y fijando cualquier pintura.

FR Excellent pour des applications sur tout type de surface, protégeant et xant toutes les peintures.

EN Excellent for applications on any kind of surface, protecting and setting any kind of paint.

IT Indicata per l'uso su qualsiasi tipo di superficie, la riparazione e la protezione di ogni tipo di pittura.

PT Excelente para aplicações em qualquer tipo de superfície, protegendo e xando qualquer pintura.

Ref						
1500 1031		Brillo / Shiny	400 ml	1	6	7,44
1500 1032		Mate / Matt	400 ml	1	6	7,44

EXPOSITORES DE PINTURA / PRESENTOIR DE PEINTURE / SPRAY DISPLAY STANDS / ESPOSITORI PER MARCATORI / EXPOSITOR DE TINTA

36 BOTES



CONTENIDO / CONTENT

Ref		RAL			
1500 1001	■	9005	400 ml	6	
1500 1003	□	9010	400 ml	6	
1500 1007	■	1023	400 ml	6	
1500 1008	■	3000	400 ml	6	
1500 1010	■	5010	400 ml	6	
1500 1012	■	6009	400 ml	6	

Ref				
1500 3699		1	36	365,50

126 BOTES



CONTENIDO / CONTENT

Ref		RAL			
1500 1003	□	9010	400 ml	6	
1500 1004	□	9010	400 ml	6	
1500 1005	□	9010	400 ml	6	
1500 1006	□	9016	400 ml	6	
1500 1015	■	9006	400 ml	6	
1500 1013	■	7001	400 ml	6	
1500 1014	■	7011	400 ml	6	
1500 1001	■	9005	400 ml	6	
1500 1002	■	9005	400 ml	6	
1500 1007	■	1023	400 ml	6	
1500 1009	■	3020	400 ml	6	
1500 1008	■	3000	400 ml	6	
1500 1010	■	5010	400 ml	6	
1500 1011	■	6005	400 ml	6	
1500 1012	■	6009	400 ml	6	
1500 1017	■	Anticalórica	400 ml	6	
1500 1018	■	Anticalórica	400 ml	6	
1500 1019	■	Cromo plata	400 ml	6	
1500 1020	■	Cromo oro	400 ml	6	
1500 1021	■	5012	400 ml	6	
1500 1022	■	Efecto forja	400 ml	6	

Ref				
1500 12699		1	126	1165,95



ESMALTES SINTÉTICOS / ÉMAIL SYNTHÉTIQUE / SYNTHETIC ENAMEL / SMALTO SINTETICO / ESMALTE SINTÉTICO

ES Esmalte al disolvente a base de resinas alquídicas, especiales. Ideal para la conservación de todo tipo de superficies exteriores e interiores.

FR Peinture au solvant à base de résines alkydes spéciales. Idéal pour la conservation de tout type de surfaces intérieures et extérieures.

EN Synthetic sealant based on special alkyd resins, possible to be polished. Ideal for the conservation of all the type of surfaces, for exterior and interior.

IT Smalto al solvente a base di resine alchidiche, speciali. Ideale per la conservazione di tutti i tipi di superfici, sia esterne che interne.

PT Esmalte dissolvente á base de resinas alquímicas, especiais. Ideal para a conservação de todo o tipo de superfícies exteriores e interiores.

125 ml



Ref						
1500 1901		Blanco brillo / Blanc brillant / Shiny white / Bianco intenso / Branco brilhante	1	10	6,71	
1500 1904		Blanco mate / Blanc mat / Matt white / Bianco opaco / Branco mate	1	10	6,71	
1500 1905		Blanco satinado / Blanc satiné / Satin white / Bianco satinato / Branco acetinado	1	10	6,71	
1500 1908		Gris perla / Gris perle / Pearl grey / Grigio perla / Cinzento pérola	1	10	6,71	
1500 1913		Gris azulado / Gris bleu / Blue grey / Grigio bluastro / Cinza azulado	1	10	6,71	
1500 1910		Gris medio / Gris moyen / Tarpaulin grey / Grigio basalto / Cinzento médio	1	10	6,71	
1500 1903		Negro brillo / Noir brillant / Jet black / Nero intenso / Preto brilhante	1	10	6,71	
1500 1907		Negro mate / Noir mat / Matt black / Nero opaco / Preto mate	1	10	6,71	
1500 1912		Negro satinado / Noir satiné / Satin black / Nero satinato / Preto acetinado	1	10	6,71	
1500 1926		Beige / Beige / Beige / Beige / Bege	1	10	6,71	
1500 1925		Crema / Crème / Cream / Crema / Creme	1	10	6,71	
1500 1919		Color marfil / Couleur ivoire / Ivory / Color avorio / Cor marfim	1	10	6,71	
1500 1920		Color gamuza / Couleur chamois / Fawn / Marrone beige / Cor camurça	1	10	6,71	
1500 1923		Amarillo real / Jaune royal / Royal yellow / Giallo reale / Amarelo real	1	10	6,71	
1500 1918		Rojo vivo / Rouge vif / Flame red / Rosso fuoco / Vermelho vivo	1	10	6,71	
1500 1922		Rojo inglés / Rouge anglais / English red / Rosso rubino perlato / Vermelho inglês	1	10	6,71	
1500 1921		Rojo carruaje / Rouge transport / Carriage red / Rosso traffico / Vermelho carruagem	1	10	6,71	
1500 1914		Ocre / Ocre / Ocher / Ocra / Ocre	1	10	6,71	
1500 1906		Color tabaco / Couleur tabac / Tabacco color / Color tabacco / Cor tabaco	1	10	6,71	
1500 1911		Tabaco oscuro / Tabac foncé / Dark tabacco / Tabacco scuro / Tabaco escuro	1	10	6,71	
1500 1916		Azul luminoso / Bleu lumineux / Bright blue / Blu cielo / Azul luminoso	1	10	6,71	
1500 1924		Azul cobalto / Bleu Cobalt / Cobalt blue / Blu cobalto / Azul cobalto	1	10	6,71	
1500 1917		Verde primavera / Vert Printemps / Leaf green / Verde primavera / Verde primavera	1	10	6,71	
1500 1915		Verde hierba / Vert herbe / Grass green / Verde erba / Verde erva	1	10	6,71	
1500 1909		Verde mayo / Vert Mai / May green / Verde maggio / Verde Maio	1	10	6,71	
1500 1902		Verde carruaje / Vert transport / Carriage green / Verde traffico / Verde carruagem	1	10	6,71	

375 ml



Ref						
1500 2201		Blanco brillo / Blanc brillant / Shiny white / Bianco intenso / Branco brilhante	1	6	12,59	
1500 2204		Blanco mate / Blanc mat / Matt white / Bianco opaco / Branco mate	1	6	12,59	
1500 2205		Blanco satinado / Blanc satiné / Satin white / Bianco satinato / Branco acetinado	1	6	12,59	
1500 2208		Gris perla / Gris perle / Pearl grey / Grigio perla / Cinzento pérola	1	6	12,59	
1500 2210		Gris medio / Gris moyen / Tarpaulin grey / Grigio basalto / Cinzento médio	1	6	12,59	
1500 2203		Negro brillo / Noir brillant / Jet black / Nero intenso / Preto brilhante	1	6	12,59	
1500 2207		Negro mate / Noir mat / Matt black / Nero opaco / Preto mate	1	6	12,59	
1500 2212		Negro satinado / Noir satiné / Satin black / Nero satinato / Preto acetinado	1	6	12,59	
1500 2218		Rojo vivo / Rouge vif / Flame red / Rosso fuoco / Vermelho vivo	1	6	12,59	
1500 2221		Rojo carruaje / Rouge transport / Carriage red / Rosso traffico / Vermelho carruagem	1	6	12,59	
1500 2214		Ocre / Ocre / Ocher / Ocra / Ocre	1	6	12,59	
1500 2206		Color tabaco / Couleur tabac / Tabacco color / Color tabacco / Cor tabaco	1	6	12,59	
1500 2216		Azul luminoso / Bleu lumineux / Bright blue / Blu cielo / Azul luminoso	1	6	12,59	
1500 2224		Azul cobalto / Bleu Cobalt / Cobalt blue / Blu cobalto / Azul cobalto	1	6	12,59	
1500 2217		Verde primavera / Vert Printemps / Leaf green / Verde primavera / Verde primavera	1	6	12,59	
1500 2215		Verde hierba / Vert herbe / Grass green / Verde erba / Verde erva	1	6	12,59	
1500 2209		Verde mayo / Vert Mai / May green / Verde maggio / Verde Maio	1	6	12,59	
1500 2202		Verde carruaje / Vert transport / Carriage green / Verde traffico / Verde carruagem	1	6	12,59	



ESMALTES SINTÉTICOS / ÉMAIL SYNTHÉTIQUE / SYNTHETIC ENAMEL / SMALTO SINTETICO / ESMALTE SINTÉTICO

750 ml



Ref						
1500 2101		Blanco brillo / Blanc brillant / Shiny white / Bianco intenso / Branco brilhante	1	6	16,90	
1500 2104		Blanco mate / Blanc mat / Matt white / Bianco opaco / Branco mate	1	6	16,90	
1500 2105		Blanco satinado / Blanc satiné / Satin white / Bianco satinato / Branco acetinado	1	6	16,90	
1500 2108		Gris perla / Gris perle / Pearl grey / Grigio perla / Cinzento pérola	1	6	16,90	
1500 2113		Gris azulado / Gris bleu / Blue grey / Grigio bluastro / Cinza azulado	1	6	16,90	
1500 2110		Gris medio / Gris moyen / Tarpaulin grey / Grigio basalto / Cinzento médio	1	6	16,90	
1500 2103		Negro brillo / Noir brillant / Jet black / Nero intenso / Preto brilhante	1	6	16,90	
1500 2107		Negro mate / Noir mat / Matt black / Nero opaco / Preto mate	1	6	16,90	
1500 2112		Negro satinado / Noir satiné / Satin black / Nero satinato / Preto acetinado	1	6	16,90	
1500 2126		Beige / Beige / Beige / Beige / Bege	1	6	16,90	
1500 2125		Crema / Crème / Cream / Crema / Creme	1	6	16,90	
1500 2119		Color marfil / Couleur ivoire / Ivory / Color avorio / Cor marfim	1	6	16,90	
1500 2120		Color gamuza / Couleur chamois / Fawn / Marrone beige / Cor camurça	1	6	16,90	
1500 2123		Amarillo real / Jaune royal / Royal yellow / Giallo reale / Amarelo real	1	6	16,90	
1500 2114		Ocre / Ocre / Ocher / Ocre / Ocre	1	6	16,90	
1500 2106		Color tabaco / Couleur tabac / Tabacco color / Color tabacco / Cor tabaco	1	6	16,90	
1500 2111		Tabaco oscuro / Tabac foncé / Dark tabacco / Tabacco scuro / Tabaco escuro	1	6	16,90	
1500 2118		Rojo vivo / Rouge vif / Flame red / Rosso fuoco / Vermelho vivo	1	6	16,90	
1500 2122		Rojo inglés / Rouge anglais / English red / Rosso rubino perlato / Vermelho inglês	1	6	16,90	
1500 2121		Rojo carruaje / Rouge transport / Carriage red / Rosso traffico / Vermelho carruagem	1	6	16,90	
1500 2116		Azul luminoso / Bleu lumineux / Bright blue / Blu cielo / Azul luminoso	1	6	16,90	
1500 2124		Azul cobalto / Bleu Cobalt / Cobalt blue / Blu cobalto / Azul cobalto	1	6	16,90	
1500 2117		Verde primavera / Vert Printemps / Leaf green / Verde primavera / Verde primavera	1	6	16,90	
1500 2115		Verde hierba / Vert herbe / Grass green / Verde erba / Verde erva	1	6	16,90	
1500 2102		Verde carruaje / Vert transport / Carriage green / Verde traffico / Verde carruagem	1	6	16,90	
1500 2109		Verde mayo / Vert Mai / May green / Verde maggio / Verde Maio	1	6	16,90	

4 L



Ref						
1500 2601		Blanco brillo / Blanc brillant / Shiny white / Bianco intenso / Branco brilhante	1	4	69,20	
1500 2604		Blanco mate / Blanc mat / Matt white / Bianco opaco / Branco mate	1	4	69,20	
1500 2605		Blanco satinado / Blanc satiné / Satin white / Bianco satinato / Branco acetinado	1	4	69,20	
1500 2608		Gris perla / Gris perle / Pearl grey / Grigio perla / Cinzento pérola	1	4	69,20	
1500 2617		Gris azulado / Gris bleu / Blue grey / Grigio bluastro / Cinza azulado	1	4	69,20	
1500 2610		Gris medio / Gris moyen / Tarpaulin grey / Grigio basalto / Cinzento médio	1	4	69,20	
1500 2603		Negro brillo / Noir brillant / Jet black / Nero intenso / Preto brilhante	1	4	69,20	
1500 2607		Negro mate / Noir mat / Matt black / Nero opaco / Preto mate	1	4	69,20	
1500 2626		Amarillo real / Jaune royal / Royal yellow / Giallo reale / Amarelo real	1	4	69,20	
1500 2606		Color tabaco / Couleur tabac / Tabacco color / Color tabacco / Cor tabaco	1	4	69,20	
1500 2618		Rojo vivo / Rouge vif / Flame red / Rosso fuoco / Vermelho vivo	1	4	69,20	
1500 2616		Azul luminoso / Bleu lumineux / Bright blue / Blu cielo / Azul luminoso	1	4	69,20	
1500 2625		Azul cobalto / Bleu Cobalt / Cobalt blue / Blu cobalto / Azul cobalto	1	4	69,20	
1500 2615		Verde hierba / Vert herbe / Grass green / Verde erba / Verde erva	1	4	69,20	
1500 2602		Verde carruaje / Vert transport / Carriage green / Verde traffico / Verde carruagem	1	4	69,20	
1500 2609		Verde mayo / Vert Mai / May green / Verde maggio / Verde Maio	1	4	69,20	

CARTA DE COLORES ESMALTES SINTÉTICOS / CARTE DE COULOEURS ÉMAIL SYNTHÉTIQUE / COLOR CHART SYNTHETIC ENAMEL  
TABELLA DEI COLORI SMALTO SINTETICO / TABELA DE CORES ESMALTE SINTÉTICO



Ref			
1500 9999		1	7,85



ESMALTE FORJA ALTA CALIDAD / ÉMAIL FORGE HAUTE QUALITÉ / FORGE EFFECT VARNISH HIGH QUALITY  
SMALTO METALLICO AD ALTA QUALITÀ / ESMALTE FORJA ALTA QUALIDADE

750 ml



ES Esmalte metálico antioxidante en color gris, ideal para dar a cualquier superficie un acabado de aspecto forjado. Excelente adherencia y resistencia en exteriores.

FR Émail métallique antioxydant de couleur grise, idéal pour donner à tout superficie un aspect forgé, excellente adhérence et résistance en extérieurs.

EN Metallic antioxidant enamel, grey. Ideal for any surface that requires forge effect finishing. Excellent adherence and resistance while using in exterior.

IT Smalto antiruggine per superfici metalliche, di colore grigio. Ideale per dare a qualsiasi superficie un aspetto finale di forgiatura. Eccellente aderenza e resistenza su oggetti esterni.

PT Esmalte metálico antioxidante de cor cinza, ideal para dar a qualquer superficie um acabamento de aspeto forjado. Excelente aderência e durabilidade exterior.

Ref						
1500 2311		Negro / Noir / Black / Nero / Preto	750 ml	1	6	16,60
1500 2312		Gris / Gris / Grey / Grigio / Cinza	750 ml	1	6	16,56

ESMALTE AL AGUA / ÉMAIL À L'EAU / WATER BASED ENAMEL / SMALTO ALL'ACQUA / ESMALTE AQUOSO

750 ml



Ref						
1500 1304		Negro brillo / Gloss black		1	6	20,55
1500 1305		Negro satinado / Satin black		1	6	20,55
1500 1306		Negro mate / Matt black		1	6	20,55
1500 1301		Blanco brillo / Gloss white		1	6	20,55
1500 1302		Blanco satinado / Satin white		1	6	20,55
1500 1303		Blanco mate / Matt white		1	6	20,55
1500 1313		Marfil claro brillo / Gloss light ivory		1	6	20,55
1500 1320		Marfil claro satinado / Satin light ivory		1	6	20,55
1500 1316		Amarillo real brillo / Gloss honey yellow		1	6	20,55
1500 1322		Rojo granada satinado / Satin fire brick red		1	6	20,55
1500 1312		Rojo vivo brillo / Gloss bright red		1	6	20,55
1500 1311		Marrón brillo / Gloss brown		1	6	20,55
1500 1323		Marrón toscana satinado / Satin caramel brown		1	6	20,55
1500 1314		Azul mediterráneo brillo / Gloss Mediterranean blue		1	6	20,55
1500 1319		Azul real satinado / Satin navy blue		1	6	20,55
1500 1315		Azul victoria brillo / Gloss royal blue		1	6	20,55
1500 1317		Azul turquesa satinado / Satin turquoise blue		1	6	20,55
1500 1321		Verde galicia satinado / Gloss dark green		1	6	20,55
1500 1318		Verde pradera satinado / Satin kelly green		1	6	20,55
1500 1308		Verde pradera brillo / Gloss kelly green		1	6	20,55
1500 1309		Verde valle brillo / Gloss olive drab green		1	6	20,55
1500 1307		Verde carruaje brillo / Gloss hunter green		1	6	20,55
1500 1310		Gris perla brillo / Gloss pearl rive grey		1	6	20,55
1500 1324		Gris perla satinado / Satin pearl rivel grey		1	6	20,55

ES Es un esmalte al agua fabricado a base de dispersiones acrílicas de altas prestaciones. Esta indicado para la protección y decoración de madera, yeso y hierro, tanto en interior como en exterior. Presenta elevada cubrición, dureza y nivelación.

FR Il s'agit des vernis à l'eau fabriqués à base de dispersions acryliques de haute performance. Indiqués pour la protection et la décoration du bois, du plâtre et du fer, à l'intérieur comme à l'extérieur. Couvrance élevée, résistance et nivellement.

EN These water based enamels are made from high performance acrylic dispersions. It is intended for wood, plaster and iron protection and decorations for both indoor and outdoor. It provides a high coverage, hardness and levelling.

IT Smalti all'acqua a base di dispersioni acquosi ad alte prestazioni. Le pitture sono destinati alla protezione e decorazioni di legno, gesso e ferro in ambienti interni ed esterni. Offre elevata copertura, durezza e livellamento.

PT É um esmalte aquoso fabricado á base de dispersões acrílicas de alto desempenho. É indicado para a proteção e decoração de madeira, gesso e ferro, tanto para interiores como exteriores. Apresenta elevada cobertura, dureza e nivelamento.

1-2 h.

Secado primera mano.  
Drying time for first coat

6-12 h.

Secado para segundas manos.  
Drying time for second and more coats.

+5°C

Temp. mínima de aplicación.  
Minimum application temp.

+30°C

Temp. máxima de aplicación.  
Maximum application temp.

8-12 m<sup>2</sup>/l

Rendimiento.  
Performance.





MINIO DE PLOMO / MINIMUM DE PLOMB / RED LEAD / MINIO DI PIOMBO / MÍNIO DE CHUMBO

750 ml / 4 L



ES Imprimación sintética a base de resinas alquídicas y minio de plomo. Especial para proteger superficies metálicas en exteriores. Gran resistencia a los agentes atmosféricos y su elevado poder antioxidante. Secado al tacto entre 30 y 60 minutos, para segundas manos 24 horas. Rendimiento: de 7 a 11 m<sup>2</sup> por litro y mano, dependiente del material.

FR Imprimé synthétique à base de résines alkydes et de minium de plomb. Spécial pour protéger des surfaces métalliques à l'extérieur. Grande résistance aux agents atmosphériques et pouvoir antioxydant important. Sec au touché entre 30 et 60 minutes, puis totalement en 24 heures. Rendement : de 7 à 11 m<sup>2</sup> par litre, en fonction du matériel.

EN Synthetic primer based on alkyd resins and red lead. Specially to protect outdoor metal surfaces. High resistance to atmospheric agents and high antioxidant power. Dry to the touch within 30 and 60 minutes, to the second coat 24 hours. Capacity: from 7 to 11 m<sup>2</sup> per litre and hand, depending on the material.

IT Primer sintetico a base di resine alchidiche e minio di piombo. Indicato per proteggere superfici metalliche esterne. Elevata resistenza agli agenti atmosferici ed elevato potere antiossidante. Asciutto al tatto entro 30 e 60 minuti. Per una seconda mano 24 ore. Resa: da 7 a 11 m<sup>2</sup> per litro, a seconda del materiale.

PT Primário sintético à base de resinas alquídicas e tetróxido de chumbo. Especial para proteger superficies de metal em exteriores. Alta resistência aos agentes atmosféricos e elevado poder antioxidante. Secagem entre 30 e 60 minutos e para segundas mãos 24 horas. Rendimento: de 7 a 11 m<sup>2</sup> por litro e por mão, dependente do material.

Ref				
1500 2306	750 ml	1	6	17,62
1500 2307	4 L	1	6	80,42

IMPRIMACIÓN SINTÉTICA / IMPRIME SYNTHÉTIQUE / SYNTHETIC PRIMER / ANTIRUGGINE SINTETICO / PRIMÁRIO SINTÉTICO



ES Imprimación fabricada a base de resinas alquídicas. Indicada para la protección y conservación de todo tipo de superficies metálicas de hierro, como estructuras, vallas, carpinterías metálicas, etc. Excelente poder antioxidante. Muy buena cubrición y rendimiento.

FR Fabrication à base de résines alkyde. Indiqué pour la protection et la conservation de tout type de surfaces métalliques, en fer, comme structures et menuiseries métalliques, clôtures, etc. Excellent pouvoir antioxydant. Très bonne couverture et excellent rendement.

EN Primer based on alkyd resin. Excellent for protecting metallic surfaces as steel, fences, metalwork, etc. Excellent antioxidant power. Very good covering and performance.

IT Primer prodotto a base di resine alchidiche. Adatto per la protezione e la conservazione di tutti i tipi di superfici metalliche in ferro, come: strutture, recinzioni, carpenteria metallica, ecc. Eccellente potere antiossidante. Ottima copertura e rendimento.

PT Primário fabricado à base de resinas alquídicas. Indicado para a proteção e conservação de todos os tipos de superfícies metálicas de ferro, tais como estruturas, vedações, armações de metal, etc. Excelente antioxidante. Desempenho e Cobertura excelentes.

Ref					
1500 2301	Gris / Gris / Grey / Grigio / Cinzento	750 ml	1	6	11,85
1500 2302	Blanco / Blanc / White / Bianco / Branco	750 ml	1	6	14,05
1500 2303	Gris / Gris / Grey / Grigio / Cinzento	4 l	1	1	54,25
1500 2304	Blanco / Blanc / White / Bianco / Branco	4 l	1	1	69,15

ESMALTE ANTIOXIDANTE / PEINTURE ANTIOXYDANTE / RUST-PROOF ENAMEL / SMALTO ANTIOSSIDANTE / ESMALTE ANTIOXIDANTE

750 ml



ES Esmalte al disolvente con resinas especiales con acabado liso brillante o satinado. Gran poder anticorrosivo y aplicable directamente sobre superficies de hierro oxidadas. No es necesaria una imprimación previa. Se aplica tanto en exteriores como en interiores.

FR Peinture au solvant à base de résines spéciales, finition lisse brillant ou satiné. Grand pouvoir anticorrosif et applicable directement sur des surfaces de fer oxydé. L'application d'une première couche n'est pas nécessaire. Usage intérieur et extérieur.

EN Synthetic sealant based on special resins, with shiny or satin finish. Great anticorrosive power and applicable directly on rusty iron surfaces. Previous coat of primer is not required, for exterior and interior.

IT Smalto al solvente a base di resine speciali con finitura liscia lucida o satinata. Grande potere anticorrosivo ed applicabile direttamente sulle superfici di ferro ossidate. Applicabile sia in ambienti esterni che interni.

PT Esmalte dissolvente com resinas especiais com um acabamento liso brilhante e acetinado. Grande poder anticorrosivo e aplicado diretamente sobre superfícies de ferro oxidadas. Não é necessário uma prévia imprimadura. Pode ser aplicado em exteriores e em interiores.

Ref					
1500 2241	Blanco brillo / Blanc brillant / Shiny white / Bianco intenso / Branco brilhante	1	6	23,93	
1500 2242	Negro brillo / Noir brillant / Jet black / Nero intenso / Preto brilhante	1	6	23,93	
1500 2243	Gris plata / Gris argent / Silver grey / Grigio argento / Cinza prata	1	6	23,93	
1500 2245	Verde carruaje / Vert transport / Carriage green / Verde traffico / Verde carruagem	1	6	23,93	

4 L



Ref					
1500 2271	Blanco brillo / Blanc brillant / Shiny white / Bianco intenso / Branco brilhante	1	4	87,84	
1500 2272	Negro brillo / Noir brillant / Jet black / Nero intenso / Preto brilhante	1	4	87,84	
1500 2273	Gris plata / Gris argent / Silver grey / Grigio argento / Cinza prata	1	4	87,84	
1500 2275	Verde carruaje / Vert transport / Carriage green / Verde traffico / Verde carruagem	1	4	87,84	



BARNIZ EXTERIOR AL AGUA / VERNIS EXTÉRIEUR À L'EAU / WATER-BASED VARNISH EXTERIOR  
IMPREGNANTE PER ESTERNI ALL'ACQUA / VERNIZ EXTERIOR DE ÁGUA

750 ml



ES Barniz acrílico transparente con múltiples aplicaciones específico para la decoración y protección de todo tipo de maderas, bien sea en interior o exterior.

FR Vernis acrylique transparent aux multiples applications, spécifique pour la décoration et la protection de tout type de bois, en intérieur ou en extérieur.

EN Acrylic transparent varnish with many applications, for decorating or protecting all the types of wood, for interior as well as exterior.

IT Impregnante acrilico trasparente con installazioni multiple. Specifico per decorazioni e protezioni di tutti i tipi di legno. Sia per interni che esterni.

PT Verniz Acrílico transparente, com múltiplas aplicações, especialmente para a decoração e protecção de todos os tipos de madeira, seja no interior ou no exterior.

Ref				
1500 2350	750 ml	1	6	15,09

## BARNIZ SINTÉTICO / VERNIS SYNTHETIQUE / SYNTHETIC VARNISH / VERNICE SINTETICA / VERNIZ SINTÉTICO

750 ml



ES Barniz alquídico de variadas prestaciones, alto brillo y elástico. Impermeable y lavable. Ideal para decoración y protección de madera en exterior e interior.

FR Vernis alkyde pour travaux variés, très brillant et élastique. Imperméable et lavable. Idéal pour décoration et protection de bois extérieur et intérieur.

EN Varied performance alkyd varnish, high brightness and elastic. Waterproof and washable. Ideal for wood decoration and protection, interior and exterior use.

IT Vernice a base di resine alchidiche di varie prestazioni, elastica e ad elevata brillantezza. Impermeabile e lavabile. Ideale per la decorazione e la protezione di interni ed esterni in legno.

PT Verniz alquídico com uma variedade de funções, alto brilho e elástico. Impermeável e lavável. Ideal para decoração e proteção da madeira em interiores e exteriores.

Ref					
1500 2340	Brillo / Brillant / Bright/ Intenso / Brilhante	750 ml	1	6	17,41
1500 2344	Satinado / Satinee / Satin / Satinato/ Satinado	750 ml	1	6	17,41
1500 2347	Mate / Mat / Matte / Opaco / Mate	750 ml	1	6	17,41

SELLADORA SINTÉTICA BLANCA / SCHELEMENT SYNTHETIQUE BLANC / WHITE SYNTHETIC SEALANT  
SIGILLANTE SINTETICO BIANCO / SELANTE SINTÉTICO BRANCO

750 ml



ES Selladora al disolvente lijable de acabado blanco mate con base de resinas alquídicas. Indicada para la preparación de maderas, yesos y escayolas, tanto en exteriores como interiores.

FR Scellement au dissolvant ponçable de finition blanc mat, à base de résines alkydes. Indiqué pour la préparation de bois, ossements et plâtres en intérieur comme extérieur.

EN Synthetic sealant with matt white finish based on alkyd resins, possible to be polished. Suitable for the preparation of wood and plaster supports, for exterior and interior.

IT Sigillante bianco opaco al solvente con finitura carteggiabile a base di resine alchidiche. Adatta per la preparazione di legni, gessi ed intonaci sia esterni che interni.

PT Selante solvente de lixamento de acabamento mate branco com resinas alquímicas. Adequado para a preparação de madeira e gesso tanto em exteriores como em interiores.

Ref				
1500 2330	750 ml	1	6	18,35



SOSA CAÚSTICA / SOUDE CAUSTIQUE / CAUSTIC SODA / SODA CAUSTICA / SODA CÁUSTICA



ES PELIGRO: Provoca quemaduras graves en la piel y lesiones oculares graves. Mantener fuera del alcance de los niños. No respirar el polvo. Lavarse la piel concienzudamente tras la manipulación. Llevar guantes/prendas/gafas/máscara de protección.

FR DANGER: Peut provoquer des brulures graves sur la peau et des lésions oculaires graves. Tenir hors de portée des enfants. Ne pas respirer les vapeurs. Laver la peau consciencieusement après toute manipulation. Porter gants/vêtements/lunettes/masque de protection.

EN DANGER: Causes severe skin burns and eye damage. Keep out of reach of children. Do not breathe dust. Wash skin thoroughly after handling. Wear protective gloves/protective clothing/eye protection/face protection.

IT PERICOLO: Provoca gravi ustioni cutanee e gravi lesioni oculari. Tenere fuori dalla portata dei bambini. Non respirare le polveri. Lavare accuratamente la pelle dopo l'utilizzo. Indossare guanti/indumenti/occhiali/maschera di protezione.

PT PERIGO: Provoca queimaduras na pele e lesões oculares graves. Mantenha fora do alcance de crianças. Não respirar o pó. Lave a pele cuidadosamente após sua utilização. Usar luvas / vestuário / óculos / proteção para a face.

Ref				
<b>1580 1010</b>	500 g	1	12	<b>4,98</b>
<b>1580 1011</b>	1 kg	1	12	<b>8,38</b>

AGUARRÁS PURO / ESSENCE DE TÉRÉBENTHINE PURE / PURE TURPENTINE / ESSENZA DI TREMENTINA / AGUARRÁS PURA



ES Aguarrás para pintura sintética, limpia brochas y otros utensilios. Llevar guantes/prendas/gafas/máscara de protección.

FR Essence de térébenthine pour peinture synthétique, nettoyage d'ustensiles. Porter des gants/vêtements/lunettes/masques de sécurité.

EN Turpentine for synthetic paints, cleaning paintbrushes and other utensils. Wear protective gloves/protective clothing/eye protection/face protection.

IT Acquaragia per vernici sintetiche, adatta per la pulizia di pennelli e altri utensili. Indossare guanti/indumenti/occhiali/maschera di protezione.

PT Aguarrás para pintura sintética, para limpar pincéis e outras ferramentas. Usar luvas/vestuário/óculos/máscara de proteção.

Ref				
<b>1580 1042</b>	500 ml	1	6	<b>4,14</b>
<b>1580 1043</b>	1 L	1	6	<b>6,78</b>

ACEITE TEKA / HUILE TEKA / OIL TEKA / OLIO DI TEAK / ÓLEO TEKA



ES Aceite destinado al tratamiento y protección de maderas exteriores. Es un producto ecológico. No contiene disolventes.

FR Huile destinée au traitement et à la protection des bois extérieurs. C'est un produit écologique. Il ne contient pas de solvants.

EN Suitable for the treatment and protection of outdoor woods. It is an ecological product. Solvent-free.

IT Olio destinato al trattamento e alla protezione di legno esterno. Prodotto ecologico. Non contiene solventi.

PT Óleo para o tratamento e proteção de madeiras exteriores. É um produto orgânico. Não contém solventes.

Ref				
<b>1580 1025</b>	1 L	1	6	<b>12,23</b>

ACEITE LINAZA / HUILE DE LIN / LINSEED OIL / OLIO DI LINO / ÓLEO LINHAÇA



ES Utilizado para limpiar baldosas cerámicas porosas o para emblanecer el vidrio cuando está duro. Actúa como lubricante de mecanismos y engranajes de precisión, como por ejemplo, las máquinas de coser o relojería. Si se aplica sobre metal, sirve para prevenir la oxidación (por ejemplo sobre herramientas metálicas). También puede utilizarse como lubricante para la perforación de vidrio o para restablecer el brillo de los muebles de madera barnizados o en otro tipo de muebles.

FR Utilisée pour nettoyer carreaux et céramiques poreux ou pour ramollir le verre quand il est dur. Agit comme lubrifiant pour des mécanismes et des pignons de précision, comme par exemple, les machines à coudre ou l'horlogerie. Si elle est appliquée sur du métal, elle sert à prévenir contre l'oxydation (par exemple, sur les outils métalliques). Elle peut également être utilisée comme lubrifiant pour la perforation de verre ou pour reconstituer le brillant des meubles de bois vernis ou tout autre type de meubles.

EN Suitable for cleaning porous ceramic floor tiles or to soften glass when it is hard. It performs as a lubricant of precision mechanisms such as sewing machines or cogs of watches. If applied on metal, it serves to prevent rusting (for instance, on metal tools). It can also be used as a lubricant to perforate glass or to restore the brightness of varnished wooden furniture or other kind of furniture.

IT Utilizzato per pulire piastrelle in ceramica porosa o per ammorbidire il vetro quando è duro. Agisce come lubrificante per meccanismi e ingranaggi di precisione, come ad esempio le macchine da cucire o gli orologi. Se applicato sul metallo serve a prevenire l'ossidazione (per esempio su strumenti metallici). Inoltre può anche essere utilizzato come lubrificante per la perforazione del vetro o per ristabilire la luminosità dei mobili in legno verniciato o per altra tipologia di mobili.

PT Usado para limpar azulejos/cerâmicas porosas ou para amolecer o vidro quando está duro. Age como um lubrificante de mecanismos e engrenagens de precisão, tais como as máquinas de costura ou relojoaria. Se aplicado no metal, serve para evitar a oxidação (por exemplo, ferramentas de metal). Também pode ser usado como um lubrificante para a perfuração do vidro de ou para restaurar o brilho de mobiliário de madeira envernizada ou outros móveis.

Ref				
<b>1580 1031</b>	500 ml	1	6	<b>6,07</b>
<b>1580 1032</b>	1 L	1	6	<b>10,22</b>



QUITAPINTURAS "GEL" / GEL DECAPANT PEINTURES / PAINT REMOVER "GEL" / SVERNICIATORE "GEL" / REMOVEDOR DE PINTURA "GEL"

500 ml



- ES Producto en gel indicado para eliminar las pinturas tanto sintéticas como plásticas. Su aspecto tipo gel sirve para la aplicación sin goteo.
- FR Produit en gel pour décaper les peintures synthétiques ou plastiques. Sa propriété en gel permet une application sans coulures.
- EN Gel indicated to remove plastic and synthetic paints. Its gel-like appearance serves for applications without dripping.
- IT Prodotto gel indicato per eliminare sia le vernici sintetiche che quelle plastiche. Il suo aspetto tipo gel serve per un'applicazione priva di sgocciolamento.
- PT Produto em gel indicado para eliminar as pinturas tanto sintéticas como plásticas. O seu aspecto tipo gel é para poder aplicar sem pingar.

Ref				
1500 2363	500 ml	1	6	17,45

DISOLVENTE UNIVERSAL / DISSOLVANT UNIVERSEL / UNIVERSAL DISOLVENT / SOLVENTE UNIVERSALE / DISSOLVENTE UNIVERSAL

500 ml / 1 L



- ES Disolvente universal ideal para dilución de imprimaciones, esmaltes y barnices sintéticos. Es posible utilizarlo como disolvente de limpieza en herramientas, útiles y diversas aplicaciones.
- FR Dissolvant universel idéal pour la dilution d'impressions, peintures et vernis synthétiques. Diverses applications possibles comme le nettoyage d'outils ou autres.
- EN Universal solvent ideal for dilution of primers, enamels and synthetic varnishes. It is possible to use it as a cleaning solvent for tools and equipments.
- IT Solvente universale ideale per la diluizione di primer, smalti e vernici sintetiche. È possibile utilizzarlo come solvente per la pulizia di strumentazioni, utensili e differenti applicazioni.
- PT Dissolvente universal ideal para a diluição de imprimaduras, esmaltes e vernizes sintéticos. Pode ser usado como um solvente para limpeza de ferramentas, utensílios, e diversas aplicações.

Ref				
1500 2366	500 ml	1	24	4,89
1500 2367	1 L	1	12	7,96

DECAPANTE EXTRA FUERTE / DECAPANT EXTRA FORT / EXTRA STRONG PAINT STRIPPER / DECAPANTE EXTRAFORTE / DECAPANTE EXTRA FORTE

750 ml



- ES Decapante semilíquido extra fuerte especial para barnices y pinturas. Es posible su aplicación a espátula o brocha sobre metales, maderas y el sector de carrocerías.
- FR Décapant semi-liquide extra fort spécial pour vernis et peintures. Son application spatule ou brosse sur les métaux, bois est possible et le secteur de carrosseries.
- EN Extra strong semi-liquid paint stripper for varnishes and paints. Can be applied on wood, metal or bodywork with scrapper or paintbrush.
- IT Decapante semilíquido extraforte, adatto a tutti i tipi di vernice. Applicabile con spatola o pennello su metallo, legno e carrozzeria.
- PT Decapante semi líquido extra forte especial para tintas e vernizes. Aplicação com espátula ou com pincel sobre metais, madeira e setor de carroçarias.

Ref				
1500 0071	750 ml	1	1	19,80



PINTURA PLÁSTICA INTERIOR / PEINTURE PLASTIQUE INTÉRIEUR / PLASTIC PAINTING INTERIOR  
PITTURA PLASTICA PER INTERNI / PINTURA PLÁSTICA INTERIOR

Interior



ES Pintura plástica "Interior" blanco mate, a base de copolímeros acrílicos. Especial para decoración de interiores por su blancura, acabado y cubrición.  
FR Peinture plastique mat blanche "intérieur", à base de copolymères acryliques. Idéal pour la décoration d'intérieur rendant une finition d'une parfaite blancheur.  
EN Plastic painting "interior", matt white. Based on acrylic copolymer. Specially for decoration of interior because of its whiteness color, finishing and covering.  
IT Pittura plastica per "interni", di colore bianco opaco. Composta da copolimeri acrilici. Ideale per la decorazione degli interni per la sua bianchezza, finitura e copertura.  
PT Tinta plástica "interior", cor branco mate à base de copolímeros acrílicos. Especial para a decoração de interiores pela sua brancura, acabamento e cobertura.

Ref					
1500 2380		Blanco / Blanc / White / Bianco / Branco	5 kg	1	13,72
1500 2381		Blanco / Blanc / White / Bianco / Branco	10 kg	1	26,95
1500 2382		Blanco / Blanc / White / Bianco / Branco	20 kg	1	44,36

PINTURA PLÁSTICA EXTERIOR / PEINTURE PLASTIQUE EXTÉRIEUR / PLASTIC PAINTING EXTERIOR  
PITTURA PLASTICA PER ESTERNI / PINTURA PLÁSTICA EXTERIOR

Exterior / Interior  
5 kg / 10 kg / 20 kg



ES Pintura plástica "Exterior" lavable color blanco mate. Fabricada a base de copolímeros acrílicos. Ideal tanto para exteriores como interiores.  
FR Peinture plastique "extérieur" de couleur blanche et mat, lavable. Fabriquée à base de copolymères acryliques. Idéal à l'intérieur comme à l'extérieur.  
EN Plastic painting "exterior" washable, matt white. Based on acrylic copolymer. Ideal for exterior as well as interior.  
IT Pittura plastica per "esterni", lavabile, di colore bianco opaco. Composta da copolimeri acrilici. Ideale sia per ambienti esterni che interni.  
PT Tinta plástica "exterior" lavável, cor branco mate. Fabricada a partir de copolímeros acrílicos. Ideal tanto para espaços interiores como exteriores.

Ref					
1500 2370		Blanco / Blanc / White / Bianco / Branco	5 kg	1	19,65
1500 2371		Blanco / Blanc / White / Bianco / Branco	10 kg	1	38,10
1500 2372		Blanco / Blanc / White / Bianco / Branco	20 kg	1	61,60

REVESTIMIENTO PÉTREO FACHADAS / REVETEMENT POUR FACADE EN PIERRE / FACADE STONE COATING  
RIVESTIMENTO PER FACCIATA IN PIETRO / REVESTIMENTO PÉTREO FACHADAS



ES Evita manchas de moho y verdines. Especial exteriores.  
FR Évite toute taches de moisissure et ver de gris. Spécial extérieurs.  
EN Avoiding mildew stains and moss. Special for outwards.  
IT Evita macchie di muffa e muschio. Speciale per esterni.  
PT Evitando manchas de mofo e verdejas. Especial exteriores.

Ref					
1500 2375		Blanco / Blanc / White / Bianco / Branco	20 kg	1	81,53

TINTE AL AGUA / PEINTURE À L'EAU / WATER BASED PAINT / VERNICE AD ACQUA / TINTA DE ÁGUA



Ref					
1500 2803		Negro / Noir / Black / Nero / Preto	50 ml	1	6 4,73
1500 2814		Ocre / Ocre / Ocher / Ocra / Ocre	50 ml	1	6 4,73
1500 2816		Azul / Bleu / Blue / Blu / Azul	50 ml	1	6 4,73
1500 2818		Rojo / Rouge / Red / Rosso / Vermelho	50 ml	1	6 4,73
1500 2823		Amarillo real / Jaune Royal / Royal yellow / Giallo reale / Amarelo Real	50 ml	1	6 4,73
1500 2827		Color sombra / Ombre / Shadow / Ombra / Sombra	50 ml	1	6 4,73
1500 2828		Salmón / Saumon / Salmon / Salmone / Salmão	50 ml	1	6 4,73
1500 2829		Verde montaña / Vert montagne / Mountain green / Verde montagna / Verde Montanha	50 ml	1	6 4,73
1500 2830		Óxido rojo / Rouge oxide / Rust red / Rosso ossido / Vermelho Ferrugem	50 ml	1	6 4,73



MASILLA PLÁSTICA AL AGUA / MASTIC PLASTIQUE À L'EAU / WATER-BASED MASTIC (PLASTIC)  
STUCCO PLASTICO ALL'ACQUA / MASSA PLÁSTICA ÁGUA

250 ml / 750 ml



ES Masilla plástica al agua ideal para relleno de grietas y nivelaciones. Soportes en yeso, escayola o madera.  
FR Mastic plastique à l'eau, idéal pour le remplissage de fissures et fentes. Supports en plâtre, béton ou bois.  
EN Water-based plastic mastic, ideal for filling up cracks and leveling. Plaster and wood supports.  
IT Stucco plastico all'acqua ideale per riempimenti di crepe e livellamenti. Installazioni in cartongesso, gesso o legno.  
PT Massa plástica para água, ideal para encher fendas e para nivelamento. Suportes em gesso ou madeira.

Ref			
1500 2360	250 ml	1	3,75
1500 2361	750 ml	1	8,25

PINTURA PLÁSTICA COLORES (MONOCAPA) / PEINTURE PLASTIQUE COULEURS (MONOCOUCHE) / PLASTIC PAINTING, COLORS (SINGLE-LAYER)  
PITTURA PLASTICA, COLORI (MONOSTRATO) / PINTURA PLÁSTICA DE CORES (MONOCAMADA)

2,5 L



Ref					
1500 2518		Manzana / Pomme / Apple / Mela / Maçã	2,5 l	1	35,05
1500 2510		Verde pistacho / Vert pistache / Pistachio green / Verde pistacchio / Verde pistachio	2,5 l	1	35,05
1500 2536		Verde medio / Vert moyen / Medium green / Verde medio / Verde médio	2,5 l	1	35,05
1500 2530		Verde yuca / Vert yuca / Cassava green / Verde erba / Verde da mandioca	2,5 l	1	35,05
1500 2529		Verde vivo / Vert vif / Bright green / Verde vivo / Verde vívido	2,5 l	1	35,05
1500 2533		Azul agua / Bleu eau / Water blue / Blu acqua / Água azul	2,5 l	1	35,05
1500 2516		Azul marino / Bleu marine / Navy blue / Blu marino / Azul marinho	2,5 l	1	35,05
1500 2535		Azul noche / Bleu nuit / Midnight blue / Blu notte / Azul meia-noite	2,5 l	1	35,05
1500 2526		Negro brillo / Noir foncé / Jet black / Nero lucido / Preto brilhante	2,5 l	1	35,05
1500 2524		Gris perla / Gris perle / Pearl grey / Grigio perla / Cinza pérola	2,5 l	1	35,05
1500 2525		Amarillo / Jaune / Yellow / Giallo / Amarelo	2,5 l	1	35,05
1500 2531		Amarillo medio / Jaune moyen / Medium yellow / Giallo medio / Amarelo médio	2,5 l	1	35,05
1500 2528		Amarillo limón / Jaune / Lemon yellow / Giallo limone / Amarelo limão	2,5 l	1	35,05
1500 2513		Marfil / Ivoire / Ivory / Avorio / Marfim	2,5 l	1	35,05
1500 2532		Beige / Beige / Beige / Beige / Bege	2,5 l	1	35,05
1500 2520		Melocotón / Pêche / Peach / Pesca / Pêssego	2,5 l	1	35,05
1500 2511		Naranja / Orange / Orange / Arancione / Laranja	2,5 l	1	35,05
1500 2523		Naranja tostado / Orange Brûlée / Burnt orange / Arancione fiamma / Laranja queimado	2,5 l	1	35,05
1500 2527		Arena / Sable / Sand / Sabbia / Areia	2,5 l	1	35,05
1500 2534		Ocre / Ocre / Ocher / Ocra / Ocre	2,5 l	1	35,05
1500 2519		Marrón chocolate / Brun chocolat / Chocolate brown / Marrone scuro / Castanho chocolate	2,5 l	1	35,05
1500 2515		Lila / Lila / Lila / Lilla / Lila	2,5 l	1	35,05
1500 2517		Magenta suave / Magenta doux / Soft magenta / Magenta inchiostro / Magenta suave	2,5 l	1	35,05
1500 2512		Magenta / Magenta / Magenta / Magenta / Magenta	2,5 l	1	35,05
1500 2522		Magenta bohemia / Magente bohème / Bohemia magenta / Magenta bohemia / Magenta boemia	2,5 l	1	35,05
1500 2537		Rojo diablo / Diable rouge / Devil red / Rosso diavolo / Vermelho diabo	2,5 l	1	35,05
1500 2521		Cereza / Cerise / Cherry / Ciliegia / Cereja	2,5 l	1	35,05
1500 2514		Violeta / Violet / Violet / Viola / Violeta	2,5 l	1	35,05



Carta colores abanico pinturas monocapa / Carte de couleurs / Color chart of single-layer paintings  
Tabella del colori / Cartas de cores de tintas plásticas monocamada

Ref		
1500 9998	1	4,95



Poster pintura 500x700 mm DIN B2 / Affiche peinture 500x700 mm din B2 / Painting poster 500x700 mm DIN B2  
Poster vernice 500x700 mm DIN B2 / Poster pintura 500x700 mm DIN B2

Ref		
1500 9997	1	2,00





IMPERMEABILIZANTE / WATERPROOFING / IMPERMÉABLE / IMPERMEABILIZZANTE / IMPERMEABILIZANTE

750 ml / 4 L / 12 L



ES Revestimiento elástico exento de productos asfálticos. Ideal para la impermeabilización de superficies en exteriores.  
FR Revêtement élastique exempt de produits asphaltiques. Idéal pour l'imperméabilisation de surfaces extérieures.  
EN Elastic covering except for asphalt products. Ideal for waterproofing exterior surfaces.  
IT Rivestimento elastico esente da materiali asfaltici. Ideale per l'impermeabilizzazione di superfici esterne.  
PT Revestimento elástico livre de produtos asfálticos. Ideal para a impermeabilização de superfícies exteriores.

Ref					
1500 2411		Blanco / Blanc / White / Bianco / Branco	750 ml	1	10,62
1500 2412		Rojo / Rouge / Red / Rosso / Vermelho	750 ml	1	10,62
1500 2413		Gris / Gris / Grey / Grigio / Cinzento	750 ml	1	10,86
1500 2414		Transparente / Transparent / Transparent / Trasparente / Transparente	750 ml	1	10,62
1500 2421		Blanco / Blanc / White / Bianco / Branco	4 L	1	52,40
1500 2422		Rojo / Rouge / Red / Rosso / Vermelho	4 L	1	52,40
1500 2423		Gris / Gris / Grey / Grigio / Cinzento	4 L	1	52,40
1500 2424		Transparente / Transparent / Transparent / Trasparente / Transparente	4 L	1	52,40
1500 2431		Blanco / Blanc / White / Bianco / Branco	12 L	1	142,80
1500 2432		Rojo / Rouge / Red / Rosso / Vermelho	12 L	1	142,80
1500 2433		Gris / Gris / Grey / Grigio / Cinzento	12 L	1	146,05
1500 2434		Transparente / Transparent / Transparent / Trasparente / Transparente	12 L	1	146,05

PINTURA PISCINAS / PEINTURE PISCINE / PAINT FOR SWIMMING POOLS  
ACQUA PER PISCINE / PINTURA PISCINAS

PINTURA PISCINAS AL CLOROCAUCHO / PEINTURE PISCINES CAOUTCHOUC LIQUIDE / CHLORORUBBER PAINT FOR SWIMMING POOLS  
VERNICE PER PISCINE AL CLOROCAUCCIU' / PINTURA PISCINAS BORRACHA CLORADA



ES Pintura a base de resinas de clorocaucho para la protección y pintado de piscinas, estanques y depósitos de agua no potable construidos en cualquier tipo de material, bien sean de obra nueva como de mantenimiento.  
FR Peinture à base de résines de caoutchouc chlore pour la protection des peintures de piscines, bassins et réservoirs d'eau non potable construits dans tout type de matériel, que ce soit en construction comme en rénovation.  
EN Resin based chlorinated paint for swimming pools, ponds and non-potable tank water built of any type of material, new or for maintenance.  
IT Vernice a base di resine al clorocaucciù per la protezione e la pittura di piscine, vasche e serbatoi d'acqua non potabile di qualche tipologia di materiale. Valido per materiale di nuova costruzione o in manutenzione.  
PT Pintura à base de resinas de borracha clorada, para a proteção e pintura de piscinas, lagos e reservatórios de água não potáveis construídos em qualquer material, seja nova construção ou manutenção.

Ref				
1500 2395		5 kg	1	42,39
1500 2398		5 kg	1	45,02

PINTURA PISCINAS ACRÍLICA AL AGUA / PEINTURE PISCINE ACRYLIQUE À L'EAU / ACRYLIC WATER BASED PAINT FOR SWIMMING POOLS  
VERNICE ACRILICA AD ACQUA PER PISCINE / PISCINAS PINTURA ACRÍLICA PARA ÁGUA



ES Pintura de piscinas acrílica al agua ideal para el pintado de paredes y suelos de piscinas, aplicable tanto en interiores como en exteriores.  
FR Peinture de piscines acrylique à l'eau idéale pour peindre les murs et les sols de piscines, applicable à l'intérieurs comme à l'extérieur.  
EN Water acrylic paint for swimming pools suitable for walls and grounds, applicable to interiors and exteriors.  
IT Vernice acrilica, ideale per la pittura delle pareti e dei pavimenti delle piscine. Utilizzabile sia in ambienti interni che esterni.  
PT Pintura acrílica de piscinas, à base de água, ideal para pintar paredes e pisos de piscinas, aplicáveis tanto em interiores como exteriores.

Ref				
1500 2391		5 kg	1	41,40



PALETINA TRIPLE MANGO MADERA / PINCEAU TRIPLE MANCHE BOIS / PAINT BRUSH WITH WOODEN HANDLE, TRIPLE THICKNESS  
PENNELLESA TRIPLA CON MANICO IN LEGNO / TRINCHA TRIPLE COM PEGA DE MADEIRA



ES Mango ergonómico de madera de haya encerado y barnizado. Virola de hojalata. Fibra de mezcla de cerda + PET. Fabricación pegada.

FR Manche ergonomique en bois de hêtre ciré et verni. Virole en étain. Fibre mélange naturelle + PET. Fabrication collée.

EN Ergonomic handle made of wax and varnished beechwood. Tin plate ferrule. Natural + PET bristles. Glued to the handle.

IT Manico ergonomico in legno di faggio cerato e verniciato. Ghiera in latta. Setola naturale + PET. Incollato all manico.

PT Pega ergonómica de faixa encerado e envernizado. Ponteira de estanho. Fibra mistura de cerdas + PET. Fabricação colada.

ES Recomendada para trabajos de preparación de superficie (aplicación minio, extender cola, aplicar líquidos tapaporos, etc.) Uso eventual Bricolaje. Para todo tipo de pinturas.

FR Recommandé pour les travaux de préparation de surface (application sous couche, colle, revêtements liquides, etc.). Pour tous types de peintures.

EN It is recommended for surfacing works (minium application, spread glue, application of primer liquids, etc.) Eventual use for DIY. It is used for any type of paints.

IT Si raccomanda di usare per lavori di smerigliatura (per applicazione con minio, incolare, applicare primer, ecc.) Utilizzo eventuale nel bricolage. Può essere utilizzato per tutto i tipi di vernici.

PT Recomendada para trabalhos de preparação de superfícies (aplicação primário zarcão, extender cola, aplicar tapaporos líquidos, etc.)Uso ocasional em bricolage. para todo o tipo de pinturas.

Ref	M	←→	📏	📦	📦	📦	📦
1500 6109	9	20 mm	1	1	0,74	✓	
1500 6112	12	25 mm	1	1	0,90	✓	
1500 6115	15	30 mm	1	1	1,11	✓	
1500 6118	18	40 mm	1	1	1,27	✓	
1500 6121	21	45 mm	1	1	1,68	✓	
1500 6124	24	50 mm	1	1	2,13	✓	
1500 6127	27	55 mm	1	1	2,54	✓	
1500 6130	30	60 mm	1	1	3,16	✓	
1500 6133	33	70 mm	1	1	3,90	✓	

PALETINA DOBLE MANGO AZUL / PINCEAU DOUBLE MANCHE BLEU / PAINT BRUSH WITH BLUE HANDLE, DOUBLE THICKNESS  
PENNELLESA DOPPIA CON MANICO BLU / TRINCHA DUPLA PEGA AZUL



ES Mango ergonómico de polipropileno muy resistente. Fibra de Cerda 100% natural, de calidad extra. Fabricación vulcanizada.

FR Manche ergonomique en polypropylène très résistant. Fibre 100% naturelle, qualité extra. Fabrication vulcanisée.

EN Ergonomic handle made of high-strength polypropylene. 100% natural bristles, extra quality. Vulcanised.

IT Manico ergonomico in polypropylene ad alta resistenza. Setola 100% naturale di qualità extra. Vulcanizzata.

PT Pega ergonómica muito resistente de polipropileno. Cerda 100% natural, de qualidade extra. Fabricação vulcanizada.

ES Máxima calidad. Cerdas regulares y de igual longitud. Carga mejor, suelta la pintura más despacio. Uso profesional para todo tipo de pinturas.

FR Qualité maxi. Poils réguliers de longueur égale. Charge régulière, libère peinture plus lentement. Utilisation professionnelle pour tous types de peintures.

EN Maximum quality. Regular length bristles. It holds more paint and releases it throughout the stroke. For any type of paints and professional use.

IT Massima qualità. Setola regolare e stessa lunghezza. Assorbire meglio il vernice e stendere la vernice lentamente. Può essere utilizzato per tutto i tipi di vernici con un uso professionale.

PT Máxima qualidade. Cerdas regulares e de igual comprimento. Carrega melhor, desprende a pintura mais devagar. Uso profissional para todo o tipo de pinturas.

Ref	M	←→	📏	📦	📦	📦	📦
1500 6209	9	20 mm	1	1	1,44	✓	
1500 6212	12	25 mm	1	1	1,60	✓	
1500 6215	15	30 mm	1	1	1,80	✓	
1500 6218	18	40 mm	1	1	2,05	✓	
1500 6221	21	45 mm	1	1	2,46	✓	
1500 6224	24	50 mm	1	1	2,87	✓	
1500 6227	27	55 mm	1	1	3,16	✓	
1500 6230	30	60 mm	1	1	4,59	✓	
1500 6233	33	70 mm	1	1	5,04	✓	
1500 6236	36	80 mm	1	1	6,44	✓	

PALETINA TRIPLE MANGO ROJO / PINCEAU TRIPLE MANCHE ROUGE / PAINT BRUSH WITH RED HANDLE, TRIPLE THICKNESS  
PENNELLESA TRIPLA CON MANICO ROSSO / TRINCHA TRIPLE COM PEGA VERMELHA



ES Mango ergonómico de propileno muy resistente. Virola de hierro con baño de estaño. Fibra de Cerda 100% natural + PET plumado. Fabricación vulcanizada.

FR Manche ergonomique en polypropylène très résistant. Virole en fer avec bain d'étain. Fibre 100% naturelle + PET en plume. Fabrication vulcanisée.

EN Ergonomic handle made of high-strength polypropylene. Tin plated iron ferrule. 100% natural bristles + PET. Vulcanised.

IT Manico ergonomico in polypropylene ad alta resistenza. Ghiera in ferro stagnato. Setola 100% naturale + PET. Vulcanizzata.

PT Pega ergonómica de propileno, muito resistente. Ponteira de ferro com banho de estanho. Fibra de Cerda 100% natural + PET chumbado. Fabricação vulcanizada.

ES Máxima calidad. Cerdas regulares y de igual longitud. Carga mejor, suelta la pintura más despacio. Uso profesional para todo tipo de pinturas.

FR Qualité maxi. Poils réguliers de longueur égale. Charge régulière, libère peinture plus lentement. Utilisation professionnelle pour tous types de peintures.

EN Maximum quality. Regular length bristles. It holds more paint and releases it throughout the stroke. For any type of paints and professional use.

IT Massima qualità. Setola regolare e stessa lunghezza. Assorbire meglio il vernice e stendere la vernice lentamente. Può essere utilizzato per tutto i tipi di vernici con un uso professionale.

PT Qualidade máxima. Cerdas regulares e de igual comprimento. Carrega melhor, desprende a pintura mais devagar. Uso profissional para todo o tipo de pinturas.

Ref	M	←→	📏	📦	📦	📦	📦
1500 6325	12	25 mm	1	1	2,17	✓	
1500 6340	18	40 mm	1	1	2,62	✓	
1500 6350	24	50 mm	1	1	3,53	✓	
1500 6360	30	60 mm	1	1	5,00	✓	
1500 6380	36	80 mm	1	1	9,02	✓	



PALETINA MULTI PINTURA / PINCEAU MULTI PEINTURES / MULTI PAINT BRUSH / PENNELLESA MULTI PITTURA / TRINCHA MULTI PINTURA



- ES Mango ergonómico de propileno muy resistente. Virola de hierro con baño de estaño. Fibra de Cerda 100% natural + PET plumado. Fabricación vulcanizada.
- FR Manche ergonomique en polypropylène très résistant. Virole en fer avec bain d'étain. Fibre 100% naturelle + PET en plume. Fabrication vulcanisée.
- EN Ergonomic handle made of high-strength polypropylene. Tin plated iron ferrule. 100% natural bristles + PET. Vulcanised.
- IT Manico ergonomico in polypropylene ad alta resistenza. Ghiera in ferro stagnato. Setola 100% naturale + PET. Vulcanizzata.
- PT Pega ergonómica de propileno, muito resistente. Ponteira de ferro com banho de estanho. Fibra de Cerda 100% natural + PET chumbado. Fabricação vulcanizada.

ES Máxima calidad. Cerdas regulares y de igual longitud. Carga mejor, suelta la pintura más despacio. Uso profesional para todo tipo de pinturas.

Qualité maxi. Poils réguliers de longueur égale. Charge régulière, libère peinture plus lentement. Utilisation professionnelle pour tous types de peintures.

Maximum quality. Regular length bristles. It holds more paint and releases it throughout the stroke. For any type of paints and professional use.

Massima qualità. Setola regolare e stessa lunghezza. Assorbire meglio il vernice e stendere la vernice lentamente. Può essere utilizzato per tutto i tipi di vernici con un uso professionale.

Qualidade máxima. Cerdas regulares e de igual comprimento. Carrega melhor, desprende a pintura mais devagar. Uso profissional para todo o tipo de pinturas.

Ref	M	↔	📏	📦	📦	📦	📦
<b>1500 6412</b>	12	25 mm	1	1	<b>3,08</b>	✓	
<b>1500 6418</b>	18	40 mm	1	1	<b>4,22</b>	✓	
<b>1500 6424</b>	24	50 mm	1	1	<b>5,45</b>	✓	
<b>1500 6430</b>	30	60 mm	1	1	<b>6,89</b>	✓	
<b>1500 6436</b>	36	80 mm	1	1	<b>9,96</b>	✓	

PALETINA TRIPLE ESPECIAL AL AGUA / PINCEAU TRIPLE SPÉCIAL POR PEINTURES À L'EAU / SPECIAL PAINT BRUSH FOR WATER BASED PAINT, TRIPLE THICKNESS  
PENNELLESA TRIPLA SPECIALE ALL'ACQUA / TRINCHA TRIPLA ESPECIAL BASE D'ÁGUA



- ES Mango ergonómico de polipropileno muy resistente. Virola de hierro con baño de estaño. Fibra de PET + PBT ø 0,16 mm. Fabricación vulcanizada.
- FR Manche ergonomique en polypropylène très résistant. Virole en fer avec bain d'étain. Fibre en PET + PBT ø 0,16 mm. Fabrication vulcanisée.
- EN Ergonomic handle made of high-strength polypropylene. Tin plated iron ferrule. PET + PBT ø 0,16 mm bristles. Vulcanised.
- IT Manico ergonomico in polypropylene ad alta resistenza. Ghiera in ferro stagnato. Setole in PET + PBT ø 0,16 mm. Fabricazione vulcanizzata.
- PT Pega ergonómica de polipropileno muito resistente. Ponteira de ferra com banho de estanho. Fibra de PET+PBTø0,16mm. Fabricação vulcanizada.

ES Máxima calidad y excelente acabado. Uso profesional para pinturas al agua.

FR Qualité maxi et excellente finition. Utilisation professionnelle pour les vernis à l'eau.

EN Maximum quality and excellent finish. Professional use for water based paints.

IT Massima qualità e ottimo finitura. Può essere utilizzato per tutto i tipi di vernici con un uso professionale.

PT Maxima qualidade e acabamento excelente. Uso profissional para pinturas á base de água.

Ref	M	↔	📏	📦	📦	📦	📦
<b>1500 6512</b>	12	25 mm	1	1	<b>2,58</b>	✓	
<b>1500 6518</b>	18	40 mm	1	1	<b>3,36</b>	✓	
<b>1500 6524</b>	24	50 mm	1	1	<b>5,25</b>	✓	
<b>1500 6530</b>	30	60 mm	1	1	<b>5,95</b>	✓	

PALETINA PARA RADIADOR / PINCEAU RADIATEUR / RADIATOR PAINT BRUSH / PENNELLO PER RADIATORE / TRINCHA PARA RADIADORES



- ES Mango de madera de haya. Virola de acero chapado. Fibra de cerda. Fabricación vulcanizada.
- FR Manche en bois de hêtre. Virole en acier plaqué. Fibre naturelle. Fabrication vulcanisée.
- EN Handle made of beech wood. Plated steel ferrule. Fiber bristles. Vulcanised.
- IT Manico in legno di faggio. Ghiera in acciaio placcato. Setola in fibra. Fabricazione vulcanizzata.
- PT Pega de madeira de faia. Ponteira em aço galvanizado. Fibra de cerda. Fabricação vulcanizada.

ES Paletina diseñada para pintar radiadores. Uso eventual.

FR Pinceau conçu pour peindre les radiateurs. Éventuelle utilisation.

EN This paint brush is designed to paint radiators. Eventual use.

IT Il pennello è progettato per tinteggiare radiatori. Utilizzo eventuale.

PT Trincha desenhada para pintar radiadores. Uso ocasional.

Ref	M	↔	📏	📦	📦	📦	📦
<b>1500 6630</b>	30	30 mm	1	1	<b>3,32</b>	✓	
<b>1500 6650</b>	50	50 mm	1	1	<b>4,76</b>	✓	



PALETINA CANARIA DE FIBRA / PINCEAU PALETTE CANARIE / CANARY FIBER BRUSH / PINCEL CANARIA DE FIBRA / PENNELLESA IN FIBRA



Ref	M	↔	📦	📦	📦	📦
1500 5001	3"	80 mm	1	12	4,01	✓
1500 5002	5"	133 mm	1	12	5,75	✓

PALETINA CANARIA DE CERDA NATURAL / PINCEAU PALETTE CANARIA SOIE NATURELLE / NATURAL-BRISTLE CANARIA BRUSH  
PENNELLESA CANARIA CON SETOLE NATURALI / TRINCHA CANARIA DE CERDA NATURAL



Ref	M	↔	📦	📦	📦	📦
1500 5005	3"	80 mm	1	12	6,15	✓
1500 5006	5"	133 mm	1	12	7,95	✓

PINCEL REDONDO PROFESIONAL / PINCEAU ROND / ROUND BRUSH / PENNELLO TONDO / PINCEL REDONDO



Ref	Nº	📦	📦	📦
1500 5021	4	1	12	0,54
1500 5022	6	1	12	0,63
1500 5023	8	1	12	0,74
1500 5024	10	1	12	0,77
1500 5025	12	1	12	0,94
1500 5026	14	1	12	1,04
1500 5027	16	1	12	1,09
1500 5028	18	1	12	1,27
1500 5029	20	1	12	1,53
1500 5030	22	1	12	1,81
1500 5031	24	1	12	3,60
1500 5032	26	1	12	5,32
1500 5033	28	1	12	6,55

BROCHA PENSADA CON COLGADOR / PINCEAU ROND AVEC ENCOCHE / COMPRESSED BRUSH WITH HANGER  
PENNELLO STROZZATO CON GANCIO / TRINCHA PENSADA PARA PENDURAR



Ref	Nº	∅	📦	📦	📦
1500 5011	6	24 mm	1	12	4,35
1500 5012	8	30 mm	1	12	5,70
1500 5013	10	35 mm	1	12	9,05
1500 5014	12	37 mm	1	12	9,70
1500 5015	14	41 mm	1	12	11,20



RODILLOS / ROULEAU / PAINT ROLLER / RULLO / ROLO



Rodillo fachadas hilo acolchado.  
Rouleau façades fil rembourré.  
Paint roller for exterior walls quilt thread.  
Rullo cordonato.  
Rolo fachadas fio acolchuado.

Ref	↔	∅	📏	📦	📦
<b>1500 5818</b>	18 cm	6 cm	1	24	<b>11,57</b>
<b>1500 5822</b>	22 cm	6 cm	1	24	<b>13,88</b>



Rodillo lana mango profi.  
Rouleau laine manche profi.  
Wool paint roller profi handle.  
Rullo lana, manico profess.  
Rolo la cabo profi.

Ref	↔	∅	📏	📦	📦
<b>1500 5618</b>	18 cm	5 cm	1	24	<b>10,92</b>
<b>1500 5619</b>	22 cm	5 cm	1	24	<b>12,17</b>

RODILLO HILO SUPERFICIES RUGOSAS / ROULEAU DE FIL POUR SURFACES RUGUEUSES / THREAD PAINT ROLLER FOR ROUGH SURFACES  
RULLO CON FILO PER SUPERFICI RUVIDE / ROLO DE FIO PER SUPERFÍCIES TEXTURIZADAS



Ref	↔	∅	📏	📦	📦
<b>1500 5530</b>	22 cm	4,5 cm	1	60	<b>5,90</b>

RODILLO SUPERFICIES LISAS / ROULEAU À PEINTURE POUR SURFACES LISSES / PAINT ROLLER FOR SMOOTH SURFACES  
RULLO PER SUPERFICI LISCIE / ROLO PARA SUPERFÍCIES LISAS



Ref	↔	∅	📏	📦	📦
<b>1500 5535</b>	18 cm	4,5 cm	1	70	<b>5,25</b>
<b>1500 5536</b>	22 cm	4,5 cm	1	60	<b>5,90</b>





RODILLO UNIVERSAL UN SOLO USO / ROULEAU À PEINTURE UNIVERSEL À USAGE UNIQUE / UNIVERSAL PAINT ROLLER FOR SINGLE-USE  
RULLO MONOUSO UNIVERSALE / ROLO UNIVERSAL DE UTILIZAÇÃO ÚNICA



Ref	↔	∅	📏	📦	📊
<b>1500 5538</b>	22 cm	4,5 cm	1	60	<b>4,35</b>

RODILLO ANTIGOTA PROFESIONAL / ROULEAU À PEINTURE PROFESSIONNEL ANTI GOUTTE / PROFESSIONAL NON-DRIP PAINT ROLLER  
RULLO PROFESSIONALE ANTI GOCCIA / ROLO PROFISSIONAL ANTI-GOTA



Ref	↔	∅	📏	📦	📊
<b>1500 5561</b>	18 cm	5 cm	1	55	<b>7,30</b>
<b>1500 5562</b>	22 cm	5 cm	1	50	<b>8,36</b>

RODILLO HILO PAREDES RUGOSAS PROFESIONAL / ROULEAU À PEINTURE PROFESSIONNEL DE FIL POUR SUFACES RUGUEUSES  
PROFESSIONAL THREAD PAINT ROLLER FOR ROUGH SURFACES / RULLO CON FILO PER SUPERFICI RUVIDE  
ROLO DE FIO PROFISSIONAL PARA SUPERFÍCIES TEXTURIZADAS

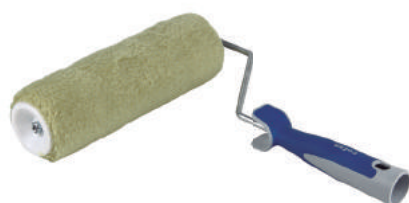

Ref	↔	∅	📏	📦	📊
<b>1500 5565</b>	22 cm	5 cm	1	50	<b>9,35</b>

RODILLO CANTONEADO P. LISAS PROFESIONAL / ROULEAU À PEINTURE PROFESSIONNEL EN BOUT ARRONDI POUR SURFACES LISSES  
PROFESSIONAL ROUND EDGE PAINT ROLLER FOR SMOOTH SURFACES / RULLO PROFESSIONALE CON BORDI ARROTONNDATI PER SUPERFICI LISCIA  
ROLO PROFISSIONAL COM EXTREMIDADES ARREDONDADAS PARA SUPERFÍCIES LISAS



Ref	↔	∅	📏	📦	📊
<b>1500 5566</b>	22 cm	6 cm	1	40	<b>11,69</b>



RODILLO HILO CANTONEADO P. RUGO. PROFES. / ROULEAU À PEINTURE PROFESSIONNEL EN FIL BOUT ARRONDI POUR SURFACES RUGUEUSES  
PROFESSIONAL ROUND EDGE THREAD PAINT ROLLER FOR ROUGH SURFACES / RULLO PROFESSIONALE CON FILO E BORDI ARROTONDATI PER SUPERFICI LISCIA  
ROLO PROFESSIONAL COM FILO E EXTREMIDADES ARREDONDADAS PARA SUPERFÍCIES ÁSPERAS



Ref	↔	∅	📏	📦	📊
<b>1500 5567</b>	22 cm	6 cm	1	40	<b>14,43</b>

RODILLO LANA ESMALTAR PROFESIONAL / ROULEAU À PEINTURE EN LAINE PROFESSIONNEL POUR ÉMAILLER  
PROFESSIONAL WOOL PAINT ROLLER FOR ENAMEL / RULLO PROFESSIONALE DI LANA PER SMALTARE  
ROLO A LÃ PROFESIONAL PARA ESMALTAR



Ref	↔	∅	📏	📦	📊
<b>1500 5568</b>	18 cm	4 cm	1	24	<b>6,97</b>

PACK 2 RECAMBIOS MINIRODILLOS MULTIUSO / PACK 2 RECHANGES MINI ROULEAU À PEINTURE MULTI-USAGE  
PACK 2 MULTIPURPOSE MINI P.O. PAINT ROLLER REFILLS / PACK 2 MINI RULLI DI RICAMBIO MULTIUSO  
PACK 2 REFIL MINI ROLOS P.O. MULTIUSOS



**PACK 2 PCS**

Ref	↔	∅	📏	📦	📊
<b>1500 5571</b>	6 cm	1,8 cm	1	120	<b>1,89</b>
<b>1500 5574</b>	11 cm	1,8 cm	1	100	<b>2,05</b>

PACK 2 RECAMBIOS MINI RODILLOS PAREDES LISAS / PACK 2 RECHANGES DE MINI ROULEAU À PEINTURE POUR SUFACES LISSES  
PACK 2 MINI P.O. PAINT ROLLER REFILLS FOR SMOOTH SURFACES / PACK 2 MINI RULLI DI RICAMBIO PER SUPERFICI LISCE  
PACK 2 MINI REFIL ROLOS PARA SUPERFÍCIES LISAS



**PACK 2 PCS**

Ref	↔	∅	📏	📦	📊
<b>1500 5572</b>	6 cm	1,8 cm	1	200	<b>2,13</b>
<b>1500 5575</b>	11 cm	1,8 cm	1	170	<b>2,75</b>

PACK 2 RECAMBIOS MINI RODILLO ESMALTAR/BARNIZAR / PACK 2 RECHANGES DE MINI ROULEAU À PEINTURE POUR ÉMAILLER/VERNIR  
PACK 2 MINI PAINT ROLLER REFILL FOR ENAMEL/VARNISH / PACK 2 MINI RULLI DI RICAMBIO PER SMALTARE/VERNICIARE  
PACK 2 MINI REFIL ROLOS PARA ESMALTAR/ENVERNIZAR



**PACK 2 PCS**

Ref	↔	∅	📏	📦	📊
<b>1500 5573</b>	6 cm	1,8 cm	1	200	<b>2,13</b>
<b>1500 5576</b>	11 cm	1,8 cm	1	170	<b>2,75</b>



MINI RODILLO MULTIUSOS PORO 0 / MINI ROULEAU À PEINTURE MULTI-USAGE PORES 0 / MINI MULTIPURPOSE PAINT ROLLER PORE 0  
MINI RULLO MULTIUSO PORO 0 / MINI ROLO MULTIUSOS PORE 0



Ref	↔	∅	📏	📦	📦
<b>1500 5581</b>	6 cm	1,8 cm	1	70	<b>2,79</b>
<b>1500 5584</b>	11 cm	1,8 cm	1	40	<b>2,91</b>

MINI RODILLO PAREDES LISAS / MINI ROULEAU À PEINTURE POUR SURFACES LISSES / MINI PAINT ROLLER FOR SMOOTH SURFACES  
MINI RULLO PER SUPERFICI LISCE / MINI ROLO PARA SUPERFÍCIES LISAS



Ref	↔	∅	📏	📦	📦
<b>1500 5582</b>	6 cm	1,8 cm	1	70	<b>3,12</b>
<b>1500 5585</b>	11 cm	1,8 cm	1	40	<b>3,28</b>

MINI RODILLO ESMALTAR / BARNIZAR VELOUR / MINI ROULEAU À PEINTURE POUR ÉMAILLER/VERNIR VELOUR  
MINI PAINT ROLLER FOR ENAMEL/VARNISH VELOUR / MINI RULLO PER SMALTARE/VERNICIARE VELOUR  
MINI ROLO PARA ESMALTAR/ENVERNIZAR VELOUR



Ref	↔	∅	📏	📦	📦
<b>1500 5583</b>	6 cm	1,8 cm	1	70	<b>3,20</b>
<b>1500 5586</b>	11 cm	1,8 cm	1	40	<b>3,62</b>

MINI RODILLO PIEL MELOCOTÓN / MINI ROULEAU À PEINTURE EN PEAU DE MOUTON / FFLOCKED FOAM ROLLER  
MINI RULLO PER PITTURA SETOLE LUNGHE / MINI ROLO PELE PESSEGO



Ref	↔	∅	📏	📦	📦
<b>1500 5587</b>	11 cm	1,8 cm	1	40	<b>4,59</b>



RODILLO ESQUINERO MANGO LARGO / ROULEAU COIN LONGUE MANGUE / PAINT ROLLER SPECIAL CORNERS LONG HANDLE  
RULLO ANGOLARE A MANICO LUNGO / ROLO ESQUINEIRO CABO LARGO



Ref			
1500 6098	1	12	6,75

MANGO PROFÍ PARA RECAMBIO / MANCHE PROFÍ DE RECHANGE / SPARE PROFÍ HANDLE  
MANICO PROFESS. PER RICAMBIO / CABO PROFÍ PARA RECAMBIO

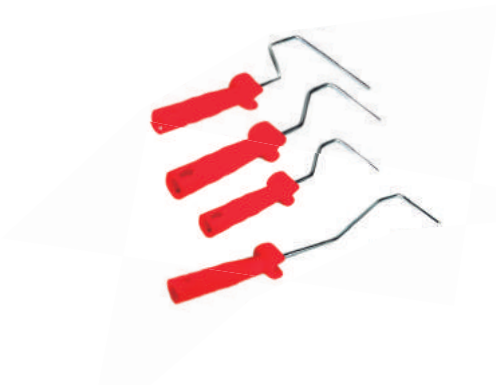

Ref	↔			
1500 5051	5 cm	1	24	1,00
1500 5052	11 cm	1	24	1,04
1500 5053	15 cm	1	24	1,24

Para radiador / Pour les radiateurs / For radiator / Per radiatore / Para radiador

Ref	↔			
1500 5054	11 cm	1	24	1,38



PACK 2 RECAMBIOS PROFÍ / PACK DE 2 ROULEAUX / 2 UNITS PACK SPARE  
CONF. DA 2 RICAMBI / PACK DE 2 RECAMBIOS

Espuma poro 0 / Rechange poro 0 / Pore foam 0 / Schiuma / Espuma poro 0

**PACK 2 PCS**

Ref	↔	∅			
1500 6001	5 cm	3,5 cm	1	40	1,11
1500 6002	11 cm	3,5 cm	1	24	2,38
1500 6003	15 cm	3,5 cm	1	20	3,67



Rodillos mini Antigota / Rouleaux mini anti-goutte / Spare anti-drip mini paint roller  
Mini rulli antigoccia / Rolos mini anti gota

**PACK 2 PCS**

Ref	↔	∅			
1500 6011	5 cm	1,5 cm	1	50	1,51
1500 6012	11 cm	1,5 cm	1	30	2,06
1500 6013	15 cm	1,5 cm	1	25	2,76



Rodillos mini Velour / Rouleaux mini velour / Spare mini velour paint roller  
Mini rulli in velluto / Rolos mini velour

**PACK 2 PCS**

Ref	↔	∅			
1500 6021	5 cm	1,5 cm	1	55	1,60
1500 6022	11 cm	1,5 cm	1	35	2,18
1500 6023	15 cm	1,5 cm	1	30	2,86



ALARGADOR PINTOR EXTENSIBLE / RALLONGE EXTENSIBLE POUR PEINTRE / EXTENSIBLE HANDLE FOR PAINTER  
MANICO ESTENSIBILE RULLO / ALARGADOR PINTOR EXTENSIVEL



Ref	↔		📦	📦	📦
<b>1500 5041</b>	1 m	0,5+0,5 m	1	12	<b>8,15</b>
<b>1500 5042</b>	2 m	1+1 m	1	12	<b>11,21</b>
<b>1500 5043</b>	3 m	1,5+1,5 m	1	12	<b>16,02</b>

CUBETA CON REJILLA 2 ASAS / CUVETTE AVEC GRILLE 2 ANSES / BUCKET WITH GRID 2 HANDLES  
VASCHETTA CON GRIGLIA, 2 MANIGLIE / TABULEIRO COM REDE 2 ASAS



Ref	📦	📦	📦
<b>1500 5596</b>	1	30	<b>6,91</b>

CUBO CUADRADO PINTOR 12 LITROS / CUVETTE CARRÉE DE PEINTRE 12 LITRES / SQUARE PAINT BUCKET 12 LITERS  
RECIPIENTE QUADRATO PER PITTURA 12 LITRI / BALDE DE TINTA QUADRADO DE 12 LITROS



Ref	📦	📦	📦
<b>1500 5594</b>	12 L	1	<b>11,10</b>

REJILLA CUBO DE PINTOR / GRILLE CUVETTE PEINTRE / PLASTIC NET 9" / GRIGLIA PITTURA PER VASCHETTA / GRELHA BALDE PINTOR



Ref	↔	📦	📦	📦
<b>1500 5595</b>	23 cm	1	100	<b>1,70</b>

KIT ESMALTAR RODILLO + CUBETA / KIT PEINTRE ROULEAU + CUVETTE / KIT FOR ENAMEL PAINT ROLLER AND TRAY  
KIT SMALTO RULLO + VASCHETTA / KIT ESMALTAR ROLO + TABULEIRO



ES Incluye: mango de 11 cm (1500 5052), rodillo 11 cm x Ø35 mm (1500 6002) y cubeta PVC.  
FR Contient : Manche de 11 cm (1500 5052), rouleau 11 cm x Ø35 mm (1500 6002), et cuvette PVC.

EN Include: handle 11 cm (1500 5052), roller 11 cm x Ø35 mm (1500 6002), and PVC bucket.

IT Include: manico da 11cm (1500 5052), rullo da 11cm x Ø35 mm (1500 6002) e secchio in PVC.

PT Inclui: Pega 11 cm (1500 5052), rolo 11 cm x Ø35 mm (1500 6002) e balde PVC.

Ref	📦	↓	📦	📦	📦
<b>1500 5091</b>	16 x 31 cm	3 pcs	1	28	<b>3,54</b>





DISPENSADOR PORTABOBINAS SOPORTE TRÍPODE / DEVIDOIR ENROULEUR BOBINE TRÉPIED / FLOOR STAND PAPER ROLL DISPENSER  
PORTA BOBINE DA TERRA / SUPORTE DISPENSADOR PORTA BOBINES TRIPE



ES Rollo no incluido.  
FR Rouleau non inclus.  
EN Paper roll is not included  
IT Rotolo di carta non incluso.  
PT Rolo não incluído.

**Mandril/Mandrel: Ø 72 mm**

ES Fabricado con un tubo de acero de Ø22 mm lacado epoxi de color gris metalizado. Cuchilla de corte de ABS de color negro con un anclaje para facilitar el cambio de bobina.  
FR Fabriqué en tube d'acier Ø22 mm, laqué époxy gris métallisé. Lame de coupe en ABS noir avec ancrage pour faciliter le changement de bobine.  
EN This wiper roll dispenser is made of a steel frame painted by epoxy coating in metallic grey colour, Ø22mm. A black ABS cutter is integrated in a sliding cover for easy paper roll change.  
IT Struttura in tubo d'acciaio Ø22mm, in colore grigio metallizzato verniciato con pittura epossidica. Il dispenser da terra ha una copertura nera mobile con bordi di strappo dentati in ABS per cambiare facilmente la bobina.  
PT Fabricado com tubo de aço de Ø22mm lacado a epoxi de cor cinza metalizado. Lâmina de corte em ABS cor preta com bucha para facilitar a troca de bobine.

Ref				
2100 1161	400 x 985 x 370 mm	2,25 kg	1	49,80

DISPENSADOR PORTABOBINAS MURAL PARED / DEVIDOIR ENROULEUR BOBINE MURAL / WALL MOUNT PAPER ROLL DISPENSER  
PORTA BOBINA DA MURO / DISPENSADOR PORTA-BOBINES DE PAREDE



ES Rollo no incluido.  
FR Rouleau non inclus.  
EN Paper roll is not included  
IT Rotolo di carta non incluso.  
PT Rolo não incluído.

**Contiene: 2 tornillos y 2 tacos de pared**  
**It contains 2 screws and 2 wall plugs**

**Mandril/Mandrel: Ø 72 mm**

ES Fabricado con un tubo de acero de Ø18 mm lacado epoxi de color gris metalizado. Cuchilla de corte de ABS de color negro.  
FR En tube d'acier Ø18 mm laqué époxy gris métal. Lame de coupe en ABS noir.  
EN This wiper dispenser is made of a steel frame painted by epoxy coating in metallic grey colour, Ø18mm. Black ABS cutter integrated.  
IT Struttura in tubo d'acciaio Ø18mm, in colore grigio metallizzato verniciato con pittura epossidica. Il dispenser ha una copertura nera con bordi di strappo dentati in ABS.  
PT Fabricado com tubo de aço de Ø18mm lacado a epoxi de cor cinza metalizado. Lâmina de corte em ABS cor preta.

Ref				
2100 1160	390 x 470 x 320 mm	0,952 kg	1	36,35

BOBINA INDUSTRIAL ECOLÓGICA / BOBINE INDUSTRIELLE ECOLOGIQUE / ECOLOGICAL INDUSTRIAL REEL  
BOBINA DI CARTA ASCIUGATUTTO / ROLO INDUSTRIAL ECOLÓGICO

20 g/m<sup>2</sup>



Ref					
1039 1060	115 m	6 uds	1 Kg	1	40,04

Ref					
1039 1061	350 m	2 uds	4 Kg	1	47,63



PLÁSTICO CUBRETUDO / PLASTIQUE DE COUVERTURE / COVER-UP PLASTIC FOIL / CELLOPHANE PROTETTIVO / PLÁSTICO COBRE TUDO



Ref					
<b>1039 1042</b>	4 m x 5 m	7 micras	1	4	<b>1,72</b>

PLÁSTICO CUBRETUDO "EXTRA FUERTE" / PLASTIQUE DE COUVERTURE "EXTRA FORT" / COVER-UP PLASTIC FOIL "EXTRA STRONG"  
CELLOPHANE PROTETTIVO "MOLTO RESISTENTE" / PLÁSTICO COBRE TUDO "EXTRA FORTE"



### EXTRA 36 My

Extra Fuerte / Extra Fort / Extra Strong / Molto Resistente / Extra Forte

Ref					
<b>1039 1043</b>	4 m x 5 m	23 micras	1	10	<b>7,44</b>

ROLLO DE PLÁSTICO "CUBRETUDO" 2 M X 50 M / ROULEAU DE PLASTIQUE DE COUVERTURE 2 M X 50 M / COVER-UP PLASTIC FOIL 2 M X 50 M  
ROLO DI CELLOPHANE PROTETTIVO 2 M X 50 M / ROLO DE PLÁSTICO "COBRE TUDO" 2 M X 50 M



Ref					
<b>1039 1041</b>	2 m x 50 m	7 micras	1	16	<b>7,70</b>

ROLLO PLÁSTICO CON CINTA CREPÉ EN UNO DE SUS EXTREMOS / ROULEAU DE PAPIER AVEC RUBAN KREPP À UNE EXTRÉMITÉ  
MASKING FOIL WITH ADHESIVE KREPP TAPE IN ONE EXTREME / ROTOLI IN PLASTICA CON NASTRO KREPP IN UNO DEI SUOI ESTREMI  
ROLO DE PLÁSTICO COM FITA KREPP EM UM DOS SEUS EXTREMOS

80 g/m<sup>2</sup>



Resistencia al calor 80°  
Résistance à la chaleur 80°  
80° heat resistant  
Resistente al calore 80°C  
Resistência ao calor 80°

ES Aplicaciones: indicado para el enmascaramiento de cualquier superficie en trabajos de pintura.  
FR Applications: indiqué pour la protection des surfaces pendant les travaux de peinture.  
EN Application: For masking any surface while painting.  
IT Applicazioni: indicato per la copertura di qualsiasi superficie in lavori di verniciatura.  
PT Aplicações: adequado para o mascaramento de qualquer superfície em trabalhos de pintura.

Ref					
<b>1039 1030</b>	35 cm x 22,5 m	110 micras	1	45	<b>3,71</b>
<b>1039 1031</b>	60 cm x 22,5 m	110 micras	1	40	<b>4,52</b>
<b>1039 1032</b>	90 cm x 22,5 m	110 micras	1	30	<b>6,01</b>
<b>1039 1033</b>	120 cm x 22,5 m	110 micras	1	20	<b>7,08</b>
<b>1039 1034</b>	180 cm x 22,5 m	110 micras	1	20	<b>9,00</b>
<b>1039 1035</b>	260 cm x 22,5 m	110 micras	1	14	<b>12,49</b>
<b>1039 1036</b>	360 cm x 22,5 m	110 micras	1	14	<b>17,47</b>



MANTA PROTECTORA SUELOS + PLÁSTICO / COUVERTURE PROTECTEUR SOLS + PLASTIQUE / FLOOR COVER FLEECE WITH FOIL-COATING  
COPERTURA PROTETTIVA PLASTIFICATA PER SUOLO / MANTA PROTECTORA PARA SOLOS PLASTIFICADA

200 g/m<sup>2</sup>



ES Manta de tejido absorbente unida a una lámina de film que lo hace impermeable y antideslizante. Aplicaciones: Está diseñada para proteger cualquier tipo de superficies de la pintura, golpes, etc. Es reutilizable y de fácil transporte.

FR Couverture tissu absorbant unie à une lame de film qui le rend imperméable et antidérapant. Applications : conçu pour protéger tout type de surfaces de la peinture, des chocs, etc. Réutilisable et facilement transportable.

EN Absorbent Cover Fleece with anti-slip foil-coating on the underside. Application: The foil prevents the penetration of paint, scratches, etc. It is reusable and easy to transport.

IT Copertura di tessuto assorbente con pellicola che la rende impermeabile e antiscivolo. Applicazioni: Progettata per proteggere qualsiasi tipo di superficie da verniciatura, colpi, ecc. È riutilizzabile e facile da trasportare.

PT Manta de tecido absorvente ligada a uma folha de película que faz com que seja à prova de água e anti-deslizamento. Aplicações: Foi concebido para proteger qualquer tipo de superfície da pintura, golpes, etc. É reutilizável e fácil de transportar.

Ref				
1039 1050	1 m x 25 m	1	41,08	✓

CINTA ADHESIVA CREPÉ CON PAPEL / ROULEAU DE PAPIER KREPP+"KRAFT" / MASKING PAPER KREPP + "KRAFT"  
ROTOLO DI CARTA KREPP + "KRAFT" / ROLO FITA CREPE+PAPEL "KRAFT" (10CM X 45MTS)

45 g

60+40 g/m<sup>2</sup>



ES Aplicaciones: indicado para el enmascaramiento en trabajos de pintura y carrocería para proteger de salpicaduras y manchas.

FR Applications: indiqué pour la protection pendant les travaux de peinture et de carrosserie afin de protéger les surfaces des projections et taches.

EN Application: for masking while painting or car body working to protect from splashes and spots.

IT Applicazioni: indicato per la copertura in lavori di verniciatura e carrozzeria per la protezione da schizzi e macchie.

PT Aplicações: adequado para mascaramento em trabalhos de pintura e chaparia para proteger contra respingos e manchas.

Ref				
1039 1021	10 cm x 45 m	1	45	3,33
1039 1022	15 cm x 45 m	1	30	3,74
1039 1023	30 cm x 45 m	1	15	5,63
1039 1024	45 cm x 45 m	1	15	6,86

ROLLO PAPEL "KRAFT" DE PRIMERA CALIDAD / ROULEAU DE PAPIER "KRAFT" DE PREMIÈRE QUALITÉ / MASKING PAPER "KRAFT" OF FIRST QUALITY  
ROTOLO DI CARTA "KRAFT" DI PRIMA QUALITÀ / ROLO DE PAPEL "KRAFT" DE PRIMEIRA QUALIDADE

45 - 50 g

40 g/m<sup>2</sup>



Ref				
1039 1011	15 cm x 45 m	1	50	1,66
1039 1012	30 cm x 45 m	1	25	3,22
1039 1013	45 cm x 45 m	1	24	4,89

Extra 50 g 50 g/m<sup>2</sup>

Ref				
1039 1014	90 cm x 45 m	1	6	12,32

ROLLO PAPEL "KRAFT" SUELOS DE PRIMERA CALIDAD / ROULEAU DE PAPIER "KRAFT" SOLS DE PREMIÈRE QUALITÉ  
FLOOR MASKING PAPER "KRAFT" OF FIRST QUALITY / ROTOLO DI CARTA "KRAFT" PER SUOLO, DI PRIMA QUALITÀ,  
ROLO DE PAPEL "KRAFT" DE PRIMEIRA QUALIDADE

Extra 65 g

65 g/m<sup>2</sup>



Ref				
1039 1020	105 cm x 45 m	1	6	16,02



FILM EMBALAJE / FEUILLE / PLASTIC FOIL / FILM IMBALLO / EMBALAGEM PELÍCULA DE PLÁSTICO



**Transparente / Transparente / Transparente / Traspasparente / Traspasparente**

Rogamos consulten precios.  
Veuillez nous consulter pour le tarif actuel.  
Please, consult the prices.  
Per favore consultare il prezzo.  
Por favor, consultem os preços.

Ref					
904 015	50 cm	23 micras	2,2 kg	1	6



**Negro / Noire / Black / Nero / Preto**

Rogamos consulten precios.  
Veuillez nous consulter pour le tarif actuel.  
Please, consult the prices.  
Per favore consultare il prezzo.  
Por favor, consultem os preços.

Ref					
904 031	50 cm	23 micras	2 kg	1	6



**Bianco / Blanc / White / Bianco / Branco**

Rogamos consulten precios.  
Veuillez nous consulter pour le tarif actuel.  
Please, consult the prices.  
Per favore consultare il prezzo.  
Por favor, consultem os preços.

Ref					
904 035	50 cm	23 micras	2 kg	1	6



**Azul / Bleu / Blue / Blu / Azul**

Rogamos consulten precios.  
Veuillez nous consulter pour le tarif actuel.  
Please, consult the prices.  
Per favore consultare il prezzo.  
Por favor, consultem os preços.

Ref					
904 036	50 cm	23 micras	2 kg	1	6



MINI FILM DE EMBALAJE 23 μ 125 M x 12,5 CM / FILM EMBALLAGE 23 μ 125 M x 12,5 CM / MINI PLASTIC FOIL 23 μ 125 M x 12,5 CM  
 FILM IMBALLO 23 μ 125 M x 12,5 CM / EMBALAGEM MINI PELÍCULA DE PLÁSTICO 23 μ 125 M x 12,5 CM



Rogamos consulten precios.  
 Veuillez nous consulter pour le tarif actuel.  
 Please, consult the prices.  
 Per favore consultare il prezzo.  
 Por favor, consultem os preços.

Ref				
1039 0031	125 m x 12,5 cm	23 micras	1	60

DISPENSADOR FILM MANUAL / SUPPORT FILM EMBALLAGE / HAND USE TRANSPARENT FILM / MANICO FILM IMBALLO / DISPENSADOR FILME MANUAL



Mango / Poignée / Handle / Manico / Suporte

Ref			
904 018	1	6	20,28

ROLLO MALLA F.DE VIDRIO REVOCOS YESO / ROULEAU FIBRE DE VERRE RAVALEMENTS PLÂTRE  
 ROLL FIBREGLASS MESH FOR RENDERING WITH PLASTER / ROTOLO RETE IN FIBRA DI VETRO INTONACO GESSO  
 ROLO MALHA F. VIDRO REBOCOS GESSO

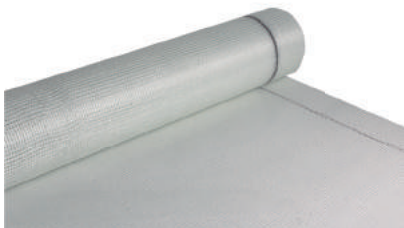

Ref				
1039 1082	1 x 10 m	5 x 5 mm	1	19,99
1039 1080	1 x 50 m	5 x 5 mm	1	53,85

ROLLO MALLA F.VIDRIO REVOCOS MORTERO / ROULEAU FIBRE DE VERRE RAVALEMENTS MORTIER  
 ROLL FIBREGLASS MESH FOR RENDERING WITH MORTAR / ROTOLO RETE IN FIBRA DI VETRO MALTA  
 ROLO MALHA F.VIDRO REBOCOS ARGAMASSA

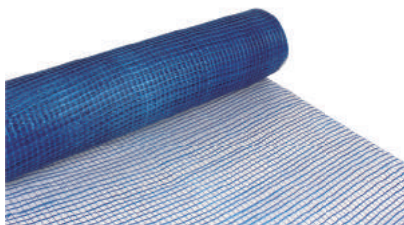

Ref				
1039 1083	1 x 10 m	10 x 10 mm	1	19,99
1039 1081	1 x 50 m	10 x 10 mm	1	55,60

MALLA DE SEÑALIZACIÓN OBRAS 1x50 M NARANJA / FILET DE SIGNALISATION CHANTIER 1x50 M M ORANGE / CONSTRUCTION SITE MESH 1x50 M ORANGE  
 RETE DI SEGNAZIONE CANTIERI 1x50 M ARANCIONE / MALHA DE SINALIZAÇÃO DE OBRAS 1x50 M M LARANJA



Ref		
1039 1085	1	35,60





PACK SACOS DE RAFIA RETRACTIL / PACK SACS DE RAFIA RÉTRACTILE / PACK OF POLYPROPYLENE RAFFIA SACKS  
 CONFEZIONE SACCHI DI RAFIA ESTENSIBILE / PACK SACOS RAFIA RETRÁTIL



Ref		PACK		x pack
<b>1039 1071</b>	500 x 800 mm	10 uds	1 pack	<b>7,80</b>
<b>1039 1072</b>	600 x 1000 mm	10 uds	1 pack	<b>10,24</b>

PACK 2 UDS. SACO DE YUTE 50X80CM / PACK 2 UNITÉS SAC DE JUTE 50X80CM / PACK OF 2 JUTE BAGS 50X80CM  
 PACK 2 SACCHI DI IUTA 50X80CM / PACK 2 UNI. SACO DE JUTA 50X80CM



Pack 2 uds.

ES El yute es una fibra vegetal natural que permite una perfecta transpiración de los productos que contienen los sacos tejidos con este material. Los sacos de yute son adecuados para envasar café, cacao, patatas, semillas, piñones, etc.

FR Le jute est une fibre végétale naturelle qui permet une parfaite respiration des produits contenant des sacs tissés avec ce matériau. Les sacs en jute conviennent au conditionnement du café, du cacao, des pommes de terre, des graines, des pignons de pin, etc.

EN Jute is a natural vegetable fibre that permits a perfect breathability for every product is contained in the sacs woven in that material. These jute bags are appropriate for packaging coffee, cocoa, potatoes, seeds, pine nuts, etc.

IT La juta è una fibra tessile naturale permette una ottima traspirabilità per gli prodotti che è contenuto nelle sacchi in questo materiale. Questi sacchi di juta sono adeguati per l'imballaggio per caffè, cacao, patate, semi, pinoli, ecc.

PT A juta é uma fibra vegetal natural que permite uma transpiração perfeita dos produtos que contém os sacos, tecidos com este material. Os sacos de juta são adequados para embalar café, cacao, batatas, pinhões e todo o tipo de sementes.

Ref					x pack
<b>1039 1073</b>		50 x 80 cm	1 pack	25 packs	<b>6,90 x pack</b>

PACK 10 SACOS DE POLYMESH 55X83CM CON PASADOR / PACK 10 SACS DE POLYMESH 55X83CM AVEC LIENS / PACK OF 10 DRAWSTRING POLYMESH BAGS  
 PACK 10 SACCHI DI RETE CON CORDONCINO / EMBALAGEM 10 SACOS DE POLYMESH 55X83CM COM FECHO



Pack 10 uds.

ES Los sacos de polymesh son especialmente adecuados para contener leña, pinaza, corteza de pino para jardín, debido a su alta aireación. Los sacos están equipados con cierre pasador para facilitar el cierre de la boca.

FR Les sacs en polymesh sont particulièrement adaptés pour contenir du bois, de la pinasse, de l'écorce de pin pour le jardin, en raison de leur forte aération. Les sacs sont équipés d'une fermeture à liens pour faciliter la fermeture du sac.

EN These polymesh bags are specially appropriated for keep firewood, pine bark mulch, thanks to its high aeration capacity. With draw-string cord to facilitate the closure of the bag.

IT Gli sacchi di rete sono specialmente adeguati per la raccolta di lena, a causa dell'alta aerazione. Gli sacchi hanno un cordoncino sull'orlo per facilitare la chiusura.

PT Os sacos Polymesh são especialmente adequados para conter lenha, pinheiro, casca de pinheiro para jardim, devido ao seu arejamento. Os sacos estão equipados com passador para facilitar o fecho da boca do saco.

Ref					x pack
<b>1039 1077</b>		55 x 83 cm	1 pack	12 packs	<b>8,95 x pack</b>
<b>1039 1078</b>		55 x 83 cm	1 pack	12 packs	<b>8,95 x pack</b>



BLÍSTER CANTONERAS ESPUMA TIPO "L" / BLISTER 2 RENFORCE MOUSSE TYPE "L" / BLISTER OF 2 FOAM CORNER PIECES "L" TYPE  
BLISTER 2 BORDINI IN SCHIUMA TIPO "L" / BLÍSTER 2 CANTONEIRAS ESPUMA TIPO "L"

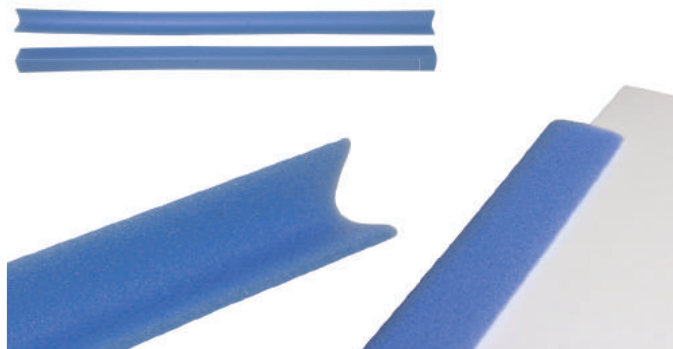

ES Cantoneras de protección en espuma con forma de "L" fabricadas en polietileno para la protección de aristas.

FR Renforcements de protection en mousse en forme de "L" fabriquée en polyéthylène pour la protection des bords.

EN Protective foam corner piece, "L" type, made of polyethylene for protecting edges.

IT Bordini di protezione in schiuma con forma a "L" fabbricati in polietilene.

PT Cantos de proteção de espuma em forma de L feitos de polietileno para a proteção de bordas.

Ref		PACK			x pack
1039 2101	50 mm x 2 m	2 uds	1 pack	12 packs	7,51

BLÍSTER CANTONERAS ESPUMA TIPO "U" / BLISTER 2 RENFORCE MOUSSE TYPE "U" / BLISTER OF 2 FOAM CORNER PIECES "U"  
BLISTER 2 BORDINI IN SCHIUMA TIPO "U" / BLÍSTER 2 CANTONEIRAS ESPUMA TIPO "U"

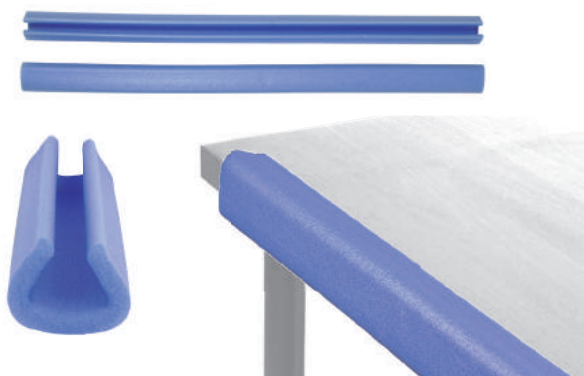

ES Cantoneras de protección en espuma con forma de "U" fabricadas en polietileno para la protección de aristas.

FR Renforcements de protection en mousse en forme de "U" fabriqués en polyéthylène pour la protection des bords.

EN Protective foam corner piece, "U" type, made of polyethylene for protecting edges.

IT Bordini di protezione in schiuma con forma a "U" fabbricati in polietilene.

PT Cantos de proteção de espuma em forma de U feitos de polietileno para a proteção de bordas.

Ref		PACK			x pack
1039 2102	45 mm x 2 m	2 uds	1 pack	12 packs	8,79

ROLLO CARTÓN ECOLÓGICO MARRÓN / ROULEAU DE CARTON ECOLOGIQUE MARRON / ECO-FRIENDLY BROWN CARDBOARD ROLL  
ROTOLO CARTONE ECOLOGICO MARRONE / ROLO CARTÃO ECOLÓGICO CASTANHO

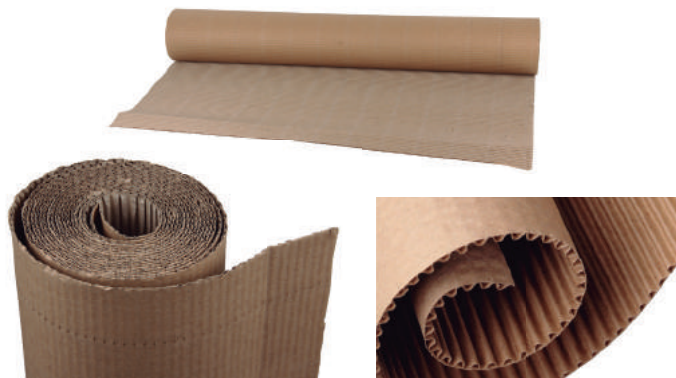

ES Cartón ecológico para protección de todo tipo de materiales y superficies con gramaje de 200 g.

FR Carton écologique pour la protection de tout type de matériels et de surfaces avec grammage de 200 g.

EN Eco-friendly cardboard for protecting any kind of material and surfaces. Weight: 200g

IT Cartone ecologico per la protezione di tutti i tipi di materiale e superfici con pesi di 200g.

PT Cartão ecológico para proteção de todos os tipos de materiais e superfícies com gramagem de 200 g.

Ref					x pack
1039 2106	0,9 x 5 m	200 g	1	18	9,81
1039 2109	0,9 x 25 m	200 g	1	1	22,30

PACK 5 SOBRES KRAFT CON BURBUJA / PACK DE 5 ENVELOPPES KRAFT A BULLES / PACK OF 5 KRAFT BUBBLE PADDED ENVELOPES  
PACK 5 BUSTE CARTA KRAFT IMBOTTITE A BOLLE D'ARIA / PACK DE 5 ENVELOPES KRAFT COM BOLHA



Pack 5 uds.

ES Bolsa de papel Kraft con cierre autoadhesivo y acolchamiento interior de plástico de burbuja para una mejor protección.

FR Enveloppe en papier kraft avec fermeture auto-adhésive et rembourrage intérieur en papier bulle pour une meilleure protection.

EN Envelope made of kraft paper with peel & seal closure and inner bubble for a better protection.

IT Busta in carta Kraft con la chiusura adesiva e l'imbottitura di film a bolle d'aria nell'interno per una per una migliore protezione.

PT Envelope de papel kraft com fecho autoadesivo e alchoamento interior de bolha plástica para melhor proteção.

Ref				x pack
1039 1086	200 x 175 mm	1 pack	20 pack	6,50 x pack
1039 1087	200 x 275 mm	1 pack	12 pack	7,25 x pack
1039 1088	250 x 350 mm	1 pack	8 pack	9,70 x pack



CAJA DE CARTÓN CON ASA TROQUEL PARA MUDANZA / BOÎTE CARTON DEMENAGEMENT AVEC ANSES DECOUPEES / CARDBOARD BOX WITH CARRY HANDLES  
SCATOLA IN CARTONE CON MANIGLIE PER TRASLOCO / CAIXA CARTÃO PARA MUDANÇAS COM ASAS TROQUEL



ES Caja de cartón para mudanza con asa troquelada para facilitar su agarre. Con imágenes de las estancias de la vivienda para una mejor identificación del contenido de la caja.

FR Boîte en carton pour déménagement avec poignée découpée pour une prise en main facile. Images des pièces de la maison intégrées pour une meilleure identification du contenu de la boîte.

EN Cardboard box with carry handles for a secure grip could be intended for moves. With pre-printed icons of rooms which allows you to easily identify the contents.

IT Scatola in cartone per trasloco con maniglie laterali per una presa facile. Con icone sulle stanze di una casa al fine di identificare facilmente il contenuto della scatola.

PT Caixa de cartão para mudanças com asa troquelada para facilitar o agarre. Com imagens das divisões da casa para uma melhor identificação do conteúdo da caixa.

Ref			
1039 2103	40 x 30 x 30 cm	10	2,96
1039 2104	60 x 40 x 40 cm	10	5,20

CHIPS DE RELLENO (BOLSA) / CHIPS DE REMPLISSAGE (SACHET) / LOOSE FILL CHIPS (BAG)  
CHIPS RIEMPIMENTO (SACCO) / CHIPS DE RECHEIO (BOLSA)



ES Chips de relleno para proteger envíos y embalajes. Absorbe golpes y estabiliza productos embalados.

FR Chips de remplissage pour protéger des envois et des emballages. Absorbe les coups et stabilise les produits emballés.

EN Protective loose fill chips for deliveries and packagings. They stabilise packaged products and they are shock-absorber.

IT Chips di riempimento per proteggere le spedizioni. Assorbe gli urti e stabilizza i prodotti imballati.

PT Chips de recheio para proteger as remessas e as embalagens. Absorve golpes e estabiliza os produtos embalados.

Ref				
1039 2107	0,10 m³	1	10	6,09

BIG BAG ESCOMBROS COLOR BLANCO / GRAND SAC POUR ENCOMBRANTS COULEUR BLANC / BIG BAG RUBBLE WHITE COLOUR  
BIG BAG MACERIE COLORE BIANCO / BIG BAG DETRITOS COR BRANCO



ES Factor de seguridad S/F 5:1 / Certificado nº. 10417.1/17.2 / Norma de ensayo: COTECNA / Clase de fibc / 1 SOLO USO.

FR Facteur de sécurité S/F 5:1 / Certificat nº 10417.1/17.2 / Norme d'essai COTECNA / Classe de FIBC / USAGE UNIQUE

EN Safety Factor S/F 5:1 / Certificate Nº. 10417.1/17.2 / Test standard COTECNA / FIBC Class / SINGLE TRIP

IT Fattore di sicurezza S/F 5:1 / Certificato Nº. 10417.1/17.2 / Standard di verifica COTECNA / Classe FIBC / 1 SOLO UTILIZZO

PT Fator de segurança S/F 5:1 / Certificado Nº. 10417.1/17.2 / Norma de ensaio COTECNA / Classe de FIBC / USAR APENAS 1 VEZ

Carga Máxima

Ref		Kg↓		
1039 1075	85 x 85 x 90 cm	1000 kg	1	8,22

BIG BAG ESCOMBROS COLOR BLANCO CON VÁLCULA DE DESCARGA / GRAND SAC POUR ENCOMBRANTS BLANC AVEC VALVE  
WHITE BIG BAG RUBBLE WITH DISCHARGE SPOUT / BIG BAG MACERIE BIANCO CON VALVOLVA DI SCARICO  
BIG BAG DETRITOS BRANCO COM VÁLVULA DE DESCARGA

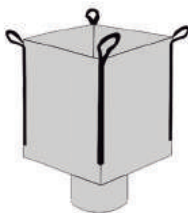

ES Factor de seguridad S/F 5:1 / Certificado nº. IIP/5534/17/LAB/IBC / Norma de ensayo: COTECNA / Clase de fibc / 1 SOLO USO.

FR Facteur de sécurité S/F 5:1 / Certificat nº IIP/5534/17/LAB/IBC / Norme d'essai COTECNA / Classe de FIBC / USAGE UNIQUE

EN Safety Factor S/F 5:1 / Certificate Nº. IIP/5534/17/LAB/IBC / Test standard COTECNA / FIBC Class / SINGLE TRIP

IT Fattore di sicurezza S/F 5:1 / Certificato Nº. IIP/5534/17/LAB/IBC / Standard di verifica COTECNA / Classe FIBC / 1 SOLO UTILIZZO

PT Fator de segurança S/F 5:1 / Certificado Nº. IIP/5534/17/LAB/IBC / Norma de ensaio COTECNA / Classe de FIBC / USAR APENAS 1 VEZ

Carga Máxima

Ref		Kg↓		
1039 1076	90 x 90 x 90 cm	1000 kg	1	9,97



ESPUMA FOAM POLIETILENO BLANCO / MOUSSE FOAM POLYÉTHYLÈNE BLANCHE / WHITE POLYETHYLENE FOAM  
 SCHIUMA FOAM POLIETILENE BIANCO / ESPUMA FOAM POLIETILENO BRANCO



ES Rollo de espuma FOAM polietileno para protección y embalajes. Medidas de 0,75 x 5 metros.

FR Rouleau de mousse FOAM polyéthylène pour protection et emballages. Mesures de 0.75 x 5 mètres.

EN Polyethylene foam for protection and packaging. Measures: 0.75 x 5 m.

IT Rotolo di schiuma FOAM in polietilene, adatto per protezioni e imballaggi. Misure: 0,75x5 metri

PT Rolo de espuma FOAM polietileno para proteção e embalagens. Medidas de 0,75 x 5 metros.

Ref					
<b>1039 2108</b>	0,75 x 5 m	2 mm	1	24	<b>6,09</b>

ROLLO FILM PE NEGRO / ROULEAU DE FILM PE NOIR / BLACK POLYETHYLENE FILM ROLL / ROTOLO FILM PE NERO / ROLO FILME PE PRETO



ES Rollo de film polietileno reciclado negro para protección de todo tipo de materiales.

FR Rouleau de film polyéthylène recyclé noir pour protection de tout type de matériels.

EN Recycled black polyethylene film roll suitable for protecting any kind of material.

IT Rotolo film in polietilene riciclato, nero, adatto per la protezione di tutti i tipi di materiale.

PT Rolo de filme de polietileno preto reciclado para proteção de todos os tipos de materiais.

**Galga 200**

Ref				
<b>1039 2111</b>	2 x 10 m	200	1	<b>18,50</b>
<b>1039 2112</b>	2 x 25 m	200	1	<b>32,67</b>
<b>1039 2113</b>	4 x 10 m	200	1	<b>28,53</b>

ROLLO FILM PE TRANSPARENTE / ROULEAU DE FILM PE TRANSPARENT / CLEAR POLYETHYLENE FILM ROLL  
 ROTOLO FILM PE TRASPARENTE / ROLO FILME PE TRANSPARENTE



ES Rollo de film polietileno reciclado translúcido para protección de todo tipo de materiales.

FR Rouleau de film polyéthylène recyclé transparent pour protection de tout type de matériels.

EN Recycled translucent polyethylene film roll suitable for protecting any kind of material.

IT Rotolo film in polietilene riciclato, traslucido, adatto per la protezione di tutti i tipi di materiale.

PT Rolo de filme de polietileno reciclado translúcido para proteção de todos os tipos de materiais.

Ref				
<b>1039 2116</b>	2 x 10 m	200	1	<b>18,50</b>
<b>1039 2117</b>	2 x 25 m	200	1	<b>32,67</b>
<b>1039 2118</b>	4 x 10 m	200	1	<b>28,53</b>
<b>1039 2131</b>	2 x 5 m	400	1	<b>12,06</b>
<b>1039 2132</b>	2 x 10 m	400	1	<b>21,07</b>
<b>1039 2133</b>	4 x 10 m	400	1	<b>43,95</b>
<b>1039 2134</b>	2 x 150 m	400	1	<b>219,30</b>
<b>1039 2135</b>	3 x 100 m	400	1	<b>219,30</b>
<b>1039 2136</b>	4 x 75 m	400	1	<b>219,30</b>

ROLLO MALLA TUBULAR ESPUMA ELÁSTICA / ROULEAU DE FILET TUBULAIRE MOUSSE ÉLASTIQUE / STRETCH FOAM NETTING ROLL  
 ROTOLO PROTEZIONE SCHIUMA ELASTICA / ROLO MALHA TUBULAR ESPUMA ELÁSTICA



ES Rollo de malla tubular extensible hasta 12 cm en espuma elástica para proteger objetos frágiles.

FR Rouleau de maille tubulaire extensible jusqu'à 12 cm en mousse élastique pour protéger des objets fragiles.

EN The stretch foam netting roll can be extended up to 12 cm and it is designed to protect fragile objects.

IT Rotolo rete tubolare estensibile sino a 12 cm in schiuma elastica. Adatto per la protezione di oggetti fragili.

PT Rolo de malha tubular extensível até 12 cm em espuma elástica para proteger objetos frágeis.

Ref				
<b>1039 2121</b>	6 / 12 cm x 5 m	1	20	<b>12,20</b>





MANTA PROTECTORA ECO / COUVERTURE DE PROTECTION ECO / BEIGE PROTECTIVE BLANKET (ECO)  
COPERTA PROTETTIVA ECO / MANTA PROTECTORA ECO



ES Manta protectora para mudanzas con gramaje en 240 gm.  
FR Couverture de protection pour déménagement, grammage 240 gm.  
EN Protective blanket for removals. Weight: 240 g  
IT Coperta protettiva per traslochi, peso 240 G  
PT Manta protetora para mudanças com gramagem de 240 g.

Ref					
1039 2122	2 x 1,5 m	240 g	1	108	14,80



ES Manta protectora para mudanzas con gramaje en 410 gm.  
FR Couverture de protection pour déménagement, grammage 410 gm.  
EN Protective blanket for removals. Weight: 410 g  
IT Coperta protettiva per traslochi, peso 410 g/m<sup>2</sup>  
PT Manta protetora para mudanças com gramagem de 410 g.

Ref					
1039 2123	2 x 1,4 m	410 g	1	8	24,73

ROLLO PLÁSTICO BURBUJA / ROULEAU PLASTIQUE BULLE / PLASTIC BUBBLE ROLL ROTOLO  
IMBALLAGGIO PLASTICO A BOLLE / ROLO DE PLÁSTICO BOLHA

MINI



ES Rollo de plástico burbuja capaz de amortiguar y proteger productos embalados. Gramaje 40 g/m<sup>2</sup>.  
FR Rouleau de papier bulle capable d'amortir et de protéger des produits emballés. Grammage 40 g/m<sup>2</sup>.  
EN The plastic bubble roll is shock-absorber and protects packaged products. Weight: 40 g/m<sup>2</sup>.  
IT Rotolo plastica con bolle, adatto per ammortizzare e proteggere i prodotti imballati. Peso 40 g/m<sup>2</sup>.  
PT Rolo de plástico bolha capaz de amortecer e proteger produtos embalados. Gramagem 40 g/m<sup>2</sup>.

Ref					
1039 2124	0,8 x 10 m	40 g/m <sup>2</sup>	1	12	10,32

ROLLO MALLA TUBULAR UNIVERSAL / ROULEAU FILET TUBULAIRE UNIVERSEL / UNIVERSAL NETTING ROLL  
ROTOLO RETE TUBOLARE UNIVERSALE / ROLO MALHA TUBULAR UNIVERSAL



ES Rollo de malla tubular universal para envasados a granel en rollos de 25 m.  
FR Rouleau de maille tubulaire universelle pour emballages en vrac rouleaux de 25 m.  
EN Universal netting roll designed for packing in bulk. 25m rolls.  
IT Rotolo da 25m, rete tubolare universale per imballaggi.  
PT Rolo de malha tubular universal para embalagem a granel em rolos de 25 m.

Ref					
1039 2125	100 mm x 25 m		1	27	17,10
1039 2126	100 mm x 25 m		1	27	17,10
1039 2127	100 mm x 25 m		1	27	17,10
1039 2128	100 mm x 25 m		1	27	17,10





CINTA ADHESIVA PVC / RUBAN ADHÉSIF PVC / PVC ADHESIVE TAPE / NASTRO ADESIVO IN PVC / FITA ADESIVA PVC



Ref							
1100 0308		amarilla / jaune / yellow giallo / amarelo	50 mm 33 m	1	6	16,22	
1100 0318		amarilla-negra / noir-jaune yellow-black / nero-giallo amarelo-preto	50 mm 33 m	1	6	15,44	
1100 0319		roja-blanca / rouge-blanc red-white / rosso-bianco vermelha-branca	50 mm 33 m	1	6	15,44	

CINTA AISLANTE DE PVC 20 M X 19 MM / ADHÉSIF ISOLANT / PLASTIC ELECTRICAL TAPE / NASTRO ISOLANTE / FITA ISOLANTE DE PVC



ES Fabricada en PVC, resistente al voltaje, al calor y diferentes ácidos y alcalinos. Se usa principalmente para aislamientos eléctricos, en el automóvil y en la industria de la electrónica.

FR Ruban isolant électrique, très bonne qualité d'isolation. Haute résistance à la tension et hautes températures. Préconisation dans les secteurs automobiles et industries électroniques.

EN Electrical tape made from PVC film, has wonderful features such as insulation, flame retardancy, cold resistance, voltage resistance, acid and alkali resistance, solvent resistance, etc.

IT Realizzato in PVC, resistente alla tensione, al calore e a numerose sostanze acide o alcaline. Utilizzato principalmente per isolamenti elettrici nelle automobili e nell'industria elettronica.

PT Feita de PVC, resistente à voltagem, ao calor, e diversos ácidos e alcalinos. É usada principalmente para o isolamento elétrico, no automóvel e indústria eletrônica.



Ref							
207 001		0,15 mm x 19 mm x 20 m	180 mm/μm	10	200	1,65	
207 002		0,15 mm x 19 mm x 20 m	180 mm/μm	10	200	1,65	
207 003		0,15 mm x 19 mm x 20 m	180 mm/μm	10	200	1,65	
207 004		0,15 mm x 19 mm x 20 m	180 mm/μm	10	200	1,65	
207 005		0,15 mm x 19 mm x 20 m	180 mm/μm	10	200	1,65	
207 006		0,15 mm x 19 mm x 20 m	180 mm/μm	10	200	1,65	
207 007		0,15 mm x 19 mm x 20 m	180 mm/μm	10	200	1,65	
207 008		0,15 mm x 19 mm x 20 m	180 mm/μm	10	200	1,65	
207 009		0,15 mm x 19 mm x 20 m	180 mm/μm	10	200	1,65	
207 010		0,15 mm x 19 mm x 20 m	180 mm/μm	10	200	1,65	
207 020		0,15 mm x 50 mm x 33 m	130 mm/μm	1	10	3,95	
207 021		0,15 mm x 50 mm x 33 m	130 mm/μm	1	10	3,95	

ROLLO CINTA PTFE / ROULEAU RUBAN PTFE / PTFE THREAD SEAL TAPE / ROTOLO NASTRO PTFE / ROLO FITA PTFE



Ref							
1039 0035	12 mm x 0,076 mm	12 m	10 uds	250 Rollos	0,50	✓	
1039 0036	12 mm x 0,10 mm	12 m	10 uds	250 Rollos	0,61	✓	
1039 0037	19 mm x 0,10 mm	50 m	10 uds	50 Rollos	3,69	✓	



CINTA DE ALUMINIO 30 MICRAS / RUBAN ALUMINIUN 30 MY / ALUMINIUN TAPE 30 MICRONE  
NASTRO DI ALLUMINIO 30 MICRON / FITA DE ALUMÍNIO 30 MICRONS

## 30 micras/microns



Ref					
1039 0010	50 mm x 45 m	1	24	7,64	✓
1039 0011	75 mm x 45 m	1	16	11,00	✓

CINTA DOBLE CARA DE ESPUMA, ESPECIAL ESPEJOS / RUBAN ADHÉSIF DOUBLE FACE MOUSSE, SPÉCIALE MIROIRS  
DOUBLE FACED TAPE WITH FOAM, SPECIAL FOR MIRRORS / NASTRO BIADESIVO IN SCHIUMA, SPECIALE PER SPECCHI  
FITA DUPLA FACE DE ESPUMA, ESPECIAL PARA ESPELHOS



ES Por su espesor y buena resistencia al deslizamiento, esta indicado para adherir espejos, cristales, metales, perchas, señales, etc. Adecuado para superficies rugosas. Espuma blanca de poliuretano de 1 mm.

FR Son épaisseur permet une bonne résistance et lui permet de ne pas glisser. Il est indiqué pour coller des miroirs, des vitres, des métaux, des signaux, etc. Convient aux surfaces rugueuses. Mousse blanche de polyuréthane de 1 mm.

EN Because of its thickness and good resistance to gliding is suitable to stick mirrors, crystals, metals, hangers, signs, etc. Suitable for rough surfaces. White polyurethane foam of 1 mm.

IT Grazie al suo spessore e all'ottima resistenza anti-scivolo, è indicato per l'utilizzo sugli specchi, vetri, metalli, ganci, cartelli, ecc. Adatto per superfici rugose. Schiuma bianca poliuretana da 1 mm.

PT Devido à sua espessura e boa resistência ao deslizamento é adequada para colar espelhos, cristais, metais, cabides, sinais, etc. Indicado para superfícies rugosas. Espuma de poliuretano branco de 1 mm.

Ref							
1039 0028	15 mm	0,75 mm	66 m	1	20	20,70	✓

CINTA DOBLE CARA PARA MOQUETA / RUBAN ADHÉSIF DOUBLE FACE POUR MOQUETTE / DOUBLE FACED TAPE FOR CARPETS  
NASTRO BIADESIVO PER MOQUETTES / FITA DUPLA FACE PARA TAPETES



ES Adecuada para la mayoría de moquetas. Excelente adhesión en superficies rugosas.

FR Convient à la majorité des moquettes. Adhésion excellente sur des surfaces rugueuses.

EN Suitable for the most of carpets. Great adhesion to the rough surface.

IT Adeguato alla maggior parte delle moquette. Eccellente presa su superfici rugose.

PT Adequado para a maioria dos tapetes. Excelente aderência à superfície áspera.

Ref							
1039 0029	25 mm	1,1 mm	25 m	1	72	5,10	✓
1039 0030	50 mm	1,1 mm	25 m	1	36	10,14	✓

PRECINTO ACRÍLICO / RUBAN ADHÉSIF ACR / ADHESIVE TAPE ACR / NASTRO ACR / FITA ADESIVA ACR

## 45 micras/microns



Marrón / Marron / Brown / Marrone / Castanho

Ref			
1039 0038	48mm x 66m	1	1,69
1039 0039	48mm x 132m	1	3,25

Blanco / Blanc / White / Bianco / Branca

Ref			
1039 0040	48mm x 132m	1	3,25



PRECINTO TRANSPARENTE ACRÍLICO / RUBAN ADHÉSIF TRANSPARENT / P.P. ADHESIVE TAPE  
 NASTRO ADESIVO TRASPARENTE / FITA TRANSPARENTE ACRÍLICA

45 micras/microns

25 g/m<sup>2</sup>



Ref					
1039 0004	48 mm x 66 m	1	36	1,73	✓
1039 0005	48 mm x 132 m	1	54	2,95	✓

CINTA DE CARROCERO "CREPÉ" / RUBAN ADHÉSIF DE MASQUAGE / MASKING TAPE / NASTRO ADESIVO / FITA DE MÁSCARA

60 g/m<sup>2</sup>



Ref					
1039 0015	18 mm x 45 m	1	12	1,36	✓
1039 0006	24 mm x 45 m	1	72	1,82	✓
1039 0016	30 mm x 45 m	1	8	2,24	✓
1039 0017	36 mm x 45 m	1	48	2,70	✓
1039 0007	48 mm x 45 m	1	36	3,59	✓
1039 0018	60 mm x 45 m	1	30	4,44	✓

CINTA AMERICANA NEGRA / AMÉRICAIN NOIR / GAFFER BLACK TAPE / NASTRO AMERICANO NERO / FITA AMERICANA PRETA

190 micras/microns



Ref					
1039 0019	50 mm x 10 m	1	36	2,50	✓
1039 0020	50 mm x 25 m	1	24	5,72	✓
1039 0021	50 mm x 50 m	1	24	8,58	✓



## CINTA AMERICANA GRIS / AMÉRICAIN GRIS / GAFFER GREY TAPE / NASTRO AMERICANO GRIGIO / FITA AMERICANA CINZENTA

**180 micras/microns**

ES Cinta americana autoadhesiva reforzada con fibra. Máxima adherencia sobre todo tipo de materiales. Color gris plata.

FR Ruban autoadhésif renforcé fibré. Adhérence maximale sur tout type de matériaux. Couleur gris argent.

EN High quality adhesive leaves just a little or no residue when removed. Cloth composition allows a consistent tear. Dull grey color.

IT Nastro adesivo rinforzato con fibra. Massima aderenza su ogni tipo di materiale. Colore grigio argento.

PT Adesivo de alta qualidade, deixa pouco ou nenhum resíduo quando removido. Máxima aderência sobre todo o tipo de materiais. Cor cinza prata.

Ref					
<b>1039 0001</b>	50 mm x 10 m	1	36	<b>1,87</b>	✓
<b>1039 0002</b>	50 mm x 25 m	1	24	<b>4,15</b>	✓
<b>1039 0003</b>	48 mm x 50 m	1	24	<b>7,90</b>	✓

## CINTA VULCANIZABLE / RUBAN ADHÉSIF POUR L'ISOLEMENT / VULCANIZABLE TAPE / NASTRO ADESIVO VULCANIZZATO / FITA VULCANIZÁVEL



ES Usada para el aislamiento eléctrico, protección, sellado, etc. Recubrimiento a prueba de agua y protección frente a la corrosión de cables. Resistente al ozono. Rollos de 10-2,5 metros con anchura de 19 mm.

FR Utilisé pour l'isolement électrique, protection, scellage, etc. Revêtement étanche et protection contre la corrosion des câbles. Résistant à l'ozone. Rouleaux de 10-2,5 mètres largeur de 19 mm.

EN It is used for electric isolation, protection, stamping, etc. Water resistant and protect against cable corrosion. Ozone resistant. Rolls of 10-2,5 m thickness of 19mm.

IT Utilizzato per l'isolamento elettrico, la protezione, la sigillatura, ecc. Rivestimento impermeabile e protetto contro la corrosione dei cavi. Resistente all'ozono. Rotoli da 10-2,5 metri con larghezza di 19mm.

PT Utilizada para isolação elétrica, proteção, vedação, etc. Revestimento à prova d'água e proteção contra a corrosão dos cabos. Resistente ao ozônio. Rolos de 10-2,5 metros com largura de 19 mm.

Ref						
<b>1039 0027</b>	<b>19 mm</b>	10 m	1	48	<b>12,38</b>	✓
<b>1039 0027BL</b>	<b>19 mm</b>	2,5 m	1	10	<b>3,85</b>	✓

## ROLLO BURLETE ADHESIVO ESPUMA BLANCA / ROULEAU MOUSSE CALFEUTRAGE ADHESIF BLANCHE / ROLL ADHESIVE DRAUGHT EXCLUDER FOAM WHITE / ROTOLO GUARNIZIONE ADESIVA, SCHIUMA BIANCA / ROLO CALAFETAÇÃO ADESIVO ESPUMA BRANCA



ES Flexible, duradero, limpio y fácil.

FR Flexible, durable, propre et facile.

EN Flexible, long-lasting, clean and easy.

IT Flessibile, duratura, pulito e facile.

PT Flexível, duradoura, limpo e fácil.

Ref					
<b>1500 0063</b>	4,5 mm x 9 m	1	24	<b>1,31</b>	





BURLETE ADHESIVO GOMA EPDM / MOUSSE DE CALFEUTRAGE ADHÉSIF DE CAOUTCHOUC EPDM / ROLL ADHESIVE DRAUGHT EXCLUDER EPDM RUBBER  
GUARNIZIONE ADESIVA IN GOMMA EPDM / FITA ADESIVA VEDANTE EM BORRACHA EPDM



- ES AISLA: Ventanas, puertas, claraboyas, etc. Compensa holguras en marcos entre 3 y 5 mm. INSTRUCCIONES: Desenrolle unos centímetros de cinta y retire el papel protector. Empezando por un ángulo pegue el burlete y ejerza presión.
- FR ISOLE: Fenêtres, portes, lucarnes, etc. Compense des écarts de 3 à 5 mm dans les corniches. INSTRUCTIONS: Déroulez quelques centimètres de rouleau, retirez le papier protecteur. En commençant par un angle, collez la jointure et exercez une pression.
- EN INSULATES: Windows, doors, skylights, etc. Fills gaps of between 3 and 5 mm. INSTRUCTIONS: Unroll a few centimetres of tape and remove the protective paper. Start to peel off the tape from a corner, then stick the draught excluder and press it firmly.
- IT ISOLA: finestra, porte, lucernari, ecc. Adatto per fessure tra 3 e 5 mm. ISTRUZIONI: Srotolare qualche centimetro di guarnizione e rimuovere la carta protettiva. Partendo da un angolo, attaccare la guarnizione ed esercitare pressione.
- PT VEDA: Portas, claraboias, janelas, etc. Compensa folgas em molduras entre 3 e 5 mm. INSTRUÇÕES: Desenrole alguns centímetros, retire o papel protetor. Començando por um ângulo, cole a fita vedante exercendo pressão.

Ref		↔	📦	📦	📦
<b>1500 0064</b>	Blancos / Blanc / White / Bianco / Branco x 3 Marrón / Brun / Brown / Marrone / Castanho x 3	9 m	6	72	<b>3,67</b>

TIRAS ANTIDESLIZANTES TRANSP. BAÑO / BANDES ANTIDÉRAPANTES TRANSP BAIN / NONSLIP STRIPS TRANSP BATHROOM  
STRISCE ANTISCIVOLO TRASPARENTI PER BAGNO / FITAS ANTIDERRAPANTES TRANSP BANHO



- ES Las tiras antideslizantes para bañera y ducha son la mejor solución para evitar caídas y resbalones en suelos húmedos o mojados. Superficie antideslizante de gran resistencia al desgaste. Adhesivo de alta duración: resistente a la inmersión en agua. Aditivos antimoho que garantizan el buen estado del producto incluso en las peores condiciones de humedad y temperatura. **APLICACIONES:** Duchas exteriores e interiores, jacuzzis e hidromasajes, bañeras y platos de ducha y saunas.
- FR Les bandes antidérapantes pour baignoires et douches sont la meilleure solution pour éviter des chutes et des glissades sur des sols humides ou mouillés. Surface antidérapante de grande résistance à l'usure. Adhésif de grande fiabilité : résistant à l'humidité. Additifs antimoisissure qui garantissent le bon état du produit même dans les pires conditions d'humidité et de température. **APPLICATIONS:** Douches extérieures et intérieures. Jacuzzis et hydromassages Baignoires et bacs à douche. Saunas.
- EN The non-slip strips for bathtubs and showers are the best solution to prevent falls and slips when the floor is damp or wet. High wear resistance and non-slip surface. Long-lasting and water-resistant adhesive. Anti-mould additives that ensures the quality of the product even in the worst conditions of dampness and temperature. **APPLICATIONS:** Indoor and outdoor showers. Jacuzzis and whirlpool baths. Showers and shower trays. Saunas.
- IT Le strisce antiscivolo per bagno e doccia sono la soluzione migliore per evitare scivolamenti e cadute su pavimenti umidi o bagnati. Superficie antiscivolo di grande resistenza all'usura. Adesivo ad alta durata: resistente all'immersione nell'acqua. Additivi antimuffa che garantiscono un buono stato del prodotto anche nelle peggiori condizioni di umidità e temperatura. **APPLICAZIONI:** Esterno e interno doccia. Jacuzzi e idromassaggio. Vasche da bagno e piatti doccia. Saune.
- PT As fitas antiderrapantes para banheira e para o chuveiro são a melhor solução para evitar quedas e escorregadelas no solo húmido ou molhado. Superfície antiderrapante de alta resistência ao desgaste. Adesivo altamente durável: resistente à imersão em água. Aditivos Anti-mofo que garantem o bom estado do produto, mesmo nas piores condições de humidade e temperatura. **APLICAÇÕES:** Duchas interiores e exteriores. Jacuzzis e hidromassagens. Banheiras e bases de duche. Saunas.

Ref	📏	PACK	📦	📦	📦 x pack
<b>1500 0062</b>	250 x 20 mm	8 uds	1 pack	12 packs	<b>3,36</b>

CINTA ANTIDESLIZANTE AMARILLA Y NEGRA 18 MX25 MM / RUBAN ANTIDÉRAPANT JAUNE ET NOIR 18 MX25 MM / BLACK AND YELLOW ANTI-SLIP TAPE 18 MX25 MM  
NASTRO ANTISCIVOLO GIALLO NERO 18 MX25 MM / FITA ANTIDESLIZANTE AMARELA E PRETA 18MX25M

ADHESIVA / ADHESIVE TAPE



- ES Logra un efecto antideslizante, eficaz en áreas o superficies que así lo requieren: escaleras, rampas, vehículos, maquinaria, etc.
- FR Effet antidérapant, efficace dans les zones ou surfaces qui le nécessitent: escaliers, rampes, véhicules, machines, etc.
- EN This anti-slip tape provides slip-resistance in surfaces where safety may be a concern. Widely used for stairs and stairwells, ramps, vehicles, machinery, etc.
- IT Questo nastro antiscivolo fornisce una resistenza antiscivolo su superfici in cui la sicurezza può essere un problema. Ideale per usare su scale, rampe, veicoli, macchinari, ecc.
- PT Consegue um efeito anti-deslizante, eficaz em áreas ou superfícies que assim o exigam: escadas, rampas, veículos, maquinaria, etc.

Ref	↔	📏	📦	📦	📦 x pack
<b>1039 0023</b>	18 m	25 mm	1	24	<b>12,40</b>
<b>1039 0024</b>	18 m	50 mm	1	12	<b>25,40</b>





	ES	FR	EN	IT	PT
<b>Ref</b>	Referencia	Référence	Reference	Riferimento	Referência
	Colores	Couleur	Color	Colore	Cores
	Capacidad, depósito	Capacité	Capacity	Capacità	Capacidade
	Packing	Conditionnement	Packing	Imballo	Embalagem
	Precio	Prix	Price	Prezzo	Preço
	Unidad mínima de venta	Nombre d'unités minimum de vente	Minimum sale unit	Quantitativo minimo di vendita	Unidade mínima de venda
	Descripción	Description	Description	Descrizione	Descrição
<b>M</b>	Métrica	Métrique	Metrical	Metrica	Métrica
	Longitud	Longueur	Length	Lunghezza	Comprimento
	Medidas	Mesures	Measurements	Misure	Medidas
	Grosor	Grosueur	Thickness	Spessore	Espessura
	Peso	Poids	Weight	Peso	Peso
	Blistér	Blister	Blister	Blister	Blister
	Contenido	Contenu	Contains	Contenuto	Inclui
	Diámetro	Diamètre	Diameter	Diametro	Diâmetro
	Galga	Galga	Gauge	Spess. µm	Calibrador
<b>Kg↓</b>	Carga máxima	Charge maximum	Maximum load	Carga máxima	Carico massimo
	Diámetro boquilla	Diamètre du buse	Nozzle diameter	Diametro dell'ugello	Diâmetro da boquilha





●.cofan

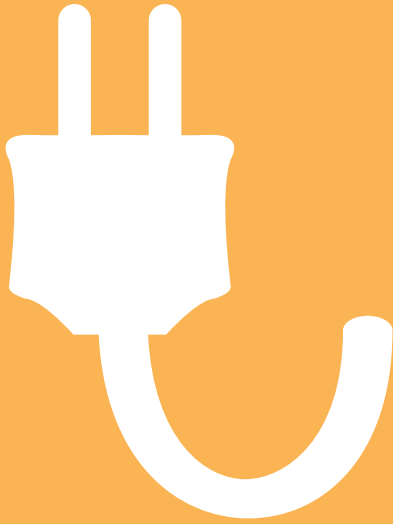



# ÍNDICE / INDEX / CONTENTS

## INDICE / ÍNDICE



**684**

PILAS ALCALINAS / PILES ALCALINES  
ALKALINE BATTERIES / PILE ALCALINEÇ  
PILHAS ALCALINAS



**693**

PROGRAMADOR HORARIO / PROGRAMMATEUR HORAIRE  
TIMER SWITCH TIME CLOCK SOCKET  
PROGRAMMATORE ORARIO / TEMPORIZADOR



**685**

PILAS RECARGABLES / PILES RECHARGEABLES  
RECHARGEABLE BATTERIES / PILE RICARICABILI  
PILHAS RECARREGÁVEIS



**693**

TERMOSTATO CALEFACCIÓN / THERMOSTAT DE CHAUFFAGE  
HEATING THERMOSTAT / TERMOSTATO RISCALDAMENTO  
TERMOSTATO DE AQUECIMENTO



**686**

PILA BOTÓN / PILE BOUTON / WATCH BATTERY  
PILE A BOTTONE / PILHA TIPO BOTÃO



**694**

DETECTORES / DETECTEURS / DETECTORS  
RILEVATORI / DETECTORES



**687**

CLAVIJAS Y ADAPTADORES / PRISES ET ADAPTATEURS  
PRISES ET ADAPTATEURS / SPINE E ADATTATORI  
FICHAS E ADAPTADORES



**695**

MECANISMOS ELÉCTRICOS DE EMPOTRAR  
MÉCANISMES ÉLECTRIQUES A ENCASTRER  
ELECTRONIC EMBED MECHANISMS  
MECCANISMI ELETTRICI INCASSATI  
MECANÍSMOS ELÉCTRICOS DE ENCASTRAR



**691**

PORTALÁMPARAS / PORTE-LAMPE / BULB SOCKET  
PORTALAMPADA / SUPORTE LÂMPADAS



**700**

MECANISMOS ELÉCTRICOS DE SUPERFICIE  
MÉCANISMES ÉLECTRIQUES DE SURFACE  
ELECTRONIC SURFACE MECHANISMS  
MECCANISMI ELETTRICI DI SUPERFICIE  
MECANÍSMOS ELÉCTRICOS DE SUPERFÍCIE





## 702

CAJAS DE EMPOTRAR MECANISMOS  
BOITIERS À ENCASTRER MÉCANISMES  
WALL BACK BOXES  
CONTENITORI AD INCASTRO PER MECCANISMI  
CAIXAS DE ENCASTRAR APARELHAGEM



## 712

CABLE TELÉFONO / CÂBLE TÉLÉPHONE  
TELEPHONE CABLE / CAVO TELEFONO  
CABO TELEFONE



## 703

ACCESORIOS MINICANAL / ACCESSOIRES MINICANAL  
MINI TRUNKING ACCESSORIES / ACCESSORI CANALINA  
ACESSORIOS MINI CALHA



## 713

LÁMPARA LED / LAMPE LED / LED LAMP  
LAMPADINA LED / LÂMPADA LED



## 705

CAJAS SUPERFICIE / BOITIERS EN APPLIQUE  
SURFACE BOXES / CONTENITORE A VISTA  
CAIXAS DE SUPERFÍCIE



## 722

DOWNLIGHTS LED / DOWNLIGHTS LED  
LED DOWNLIGHT / FARETTI LED / DOWNLIGHTS LED



## 706

CABLE ELÉCTRICO / CÂBLE ELECTRIQUE  
ELECTRICAL CABLE / CAVO ELETTRICO  
CABO ELÉTRICO



## 723

LINTERNAS / LAMPE TORCHE / TORCHES  
TORCE / LANTERNAS



## 706

MATERIAL ELÉCTRICO / MATERIEL ELECTRIQUE  
ELECTRICAL EQUIPMENT / MATERIALE ELETTRICO  
MATERIAL ELÉTRICO

## i

## 730

GLOSARIO / GLASSAIRE / GLOSSARY  
GLOSSARIO / GLOSSÁRIO



## 711

CABLE TV-SATÉLITE / CÂBLE TV-SATELLITE  
TV-SATELLITE CABLE / CAVO TV-SATELLITE  
CABO TV-SATÉLITE



PILAS ALCALINAS / PILES ALCALINES / ALKALINE BATTERIES / PILE ALCALINE / PILHAS ALCALINAS

LR 20 / 1,5 V



Ref



5000 2001 6 Blister 72 Blister 4,47 2 pcs x BL

LR 14 C/1,5 V



Ref



5000 2002 6 Blister 144 Blister 3,38 2 pcs x BL

LR 06 AA / 1,5 V



Ref



5000 2003 10 Blister 180 Blister 1,82 4 pcs x BL

LR 03 AAA / 1,5 V



Ref



5000 2004 10 Blister 180 Blister 1,82 4 pcs x BL

6LR61/9V



Ref



5000 2005 12 Blister 144 Blister 2,39 1 pc x BL

3LR12/4,5V



Ref



5000 2006 9 Blister 90 Blister 5,82 1 pc x BL

23A 12V



Ref



5000 2007 5 uds 50 0,79 ✓

27A 12V



Ref



5000 2008 5 uds 50 0,78 ✓



PILAS RECARGABLES / PILES RECHARGEABLES / RECHARGEABLE BATTERIES / PILE RICARICABILI / PILHAS RECARREGÁVEIS

**Ni-MH 1.2V AA**

AA 2300MAH



<b>Ref</b>			x BL	
<b>5000 2103</b>	1 Blíster	10 Blíster	<b>15,08</b>	4 pcs x BL

**Ni-MH 1.2V AAA**

AAA 900MAH



<b>Ref</b>			x BL	
<b>5000 2104</b>	1 Blíster	10 Blíster	<b>10,19</b>	4 pcs x BL

CARGADOR PILAS (220/240 V) / CHARGEUR PILES (220/240 V) / BATTERIES CHARGER (220/240 V)  
CARICABATTERIE PILE (220/240 V) / CARREGADOR DE PILHAS (220/240 V)

PARA/FOR: AA / AAA

**PARA 2 PILAS  
FOR 2 BATTERIES**



<b>Ref</b>				
<b>5000 2198</b>	1	24	<b>9,10</b>	✓

**PARA 4 PILAS  
FOR 4 BATTERIES**



<b>Ref</b>				
<b>5000 2199</b>	1	16	<b>9,62</b>	✓

EXPOSITOR PILAS / PRESENTOIR PILES / BATTERIES DISPLAY STAND / ESPOSITORE PILE / EXPOSITOR PARA PILHAS



CONTENIDO / CONTENT

<b>Ref</b>		
<b>5000 2001</b>	LR20 D/1,5V	12 Blíster
<b>5000 2002</b>	LR14 C/1,5V	12 Blíster
<b>5000 2003</b>	LR6 AA/1,5V	20 Blíster
<b>5000 2004</b>	LR03 AAA/1,5V	20 Blíster
<b>5000 2005</b>	6LR61 D/9V	24 Blíster
<b>5000 2006</b>	3LR12/4,5V	9 Blíster
<b>5000 2007</b>	23A 12V	50 Blíster
<b>5000 2008</b>	27A 12V	50 Blíster
<b>Ref</b>		
<b>5000 2099</b>	341 Batteries	<b>24</b>
		<b>399,60</b>



PILA BOTÓN / PILE BOUTON / WATCH BATTERY / PILE A BOTTONE / PILHA TIPO BOTÃO



**CR2016/3,0V**



Ref			x Ud	
5000 2016	5 pcs	100 pcs	0,33	✓



**CR2025/3,0V**



Ref			x Ud	
5000 2025	5 pcs	100 pcs	0,33	✓



**CR2032/3,0V**



Ref			x Ud	
5000 2032	5 pcs	100 pcs	0,33	✓



**CR1616/3,0V**



Ref			x Ud	
5000 1616	5 pcs	100 pcs	0,43	✓



**CR1620/3,0V**



Ref			x Ud	
5000 1620	5 pcs	100 pcs	0,43	✓



**CR2430/3,0V**



Ref			x Ud	
5000 2430	4 pcs	80 pcs	0,76	✓



**CR2450/3,0V**



Ref			x Ud	
5000 2450	4 pcs	80 pcs	0,86	✓





CLAVIJA BIPOLAR / CHEVILLE BIPOLAIRE / BIPOLAR PLUG / SPINA BIPOLARE / TOMADA BIPOLAR

**Bricofan**

10A / 250V  
MAX: 2300 W



Ref		A-V~			
5100 1016		10A-250V	1	10	1,40
5100 1017		10A-250V	1	10	1,40

BASE ENCHUFE BIPOLAR AÉREA / BASE PRISE BIPOLAIRE AIR / BIPOLAR PLUG SOCKET  
PRESA PER SPINA BIPOLARE / BASE TOMADA BIPOLAR AÉREA

**Bricofan**

10A / 250V  
MAX: 2300 W



Ref		A-V~			
5100 1022		10A-250V	1	10	1,88
5100 1023		10A-250V	1	10	1,88

CLAVIJA BIPOLAR GOMA / CHEVILLE BIPOLAIRE CAOUTCHOU / RUBBER BIPOLAR PLUG  
SPINA IN GOMMA BIPOLARE / TOMADA BIPOLAR BORRACHA

SCHUKO

**Bricofan**

16A / 250V  
MAX: 3680 W



Ref		A-V~			
5100 1018		16A-250V	1	10	2,97

BASE ENCHUFE AÉREA GOMA / BASE PRISE CAOUTCHOU AIR / RUBBER PLUG SOCKET  
PRESA PER SPINA IN GOMMA / BASE TOMADA AÉREA BORRACHA

PLUG

**Bricofan**

16A / 250V  
MAX: 3680 W



Ref		A-V~			
5100 1025		16A-250V	1	10	4,42

CLAVIJA BIPOLAR / CHEVILLE BIPOLAIRE / BIPOLAR PLUG / SPINA BIPOLARE / TOMADA BIPOLAR

**Bricofan**

16A / 250V  
MAX: 3680 W



Ref		A-V~			
5100 1019		16A-250V	1	10	1,88
5100 1021		16A-250V	1	10	1,88





BASE ENCHUFE BIPOLAR AÉREA / BASE PRISE BIPOLAIRE AIR / BIPOLAR PLUG SOCKET  
PRESA PER SPINA BIPOLARE / BASE TOMADA BIPOLAR AÉREA



**Bricofan**

16A / 250V  
MAX: 3680 W

Ref		A-V~			
5100 1026		16A-250V	1	10	3,11
5100 1027		16A-250V	1	10	3,11

CLAVIJA BIPOLAR / CHEVILLE BIPOLAIRE / BIPOLAR PLUG / SPINA BIPOLARE / TOMADA BIPOLAR



**Bricofan**

25A / 250V  
MAX: 3680 W

Ref		A			
5100 1014		25 A	1	10	14,33

BASE BIPOLAR (TOMA COCINA) / BASE BIPOLAIRE (PRISE CUISINE) / BIPOLAR SOCKET (KITCHEN PLUG)  
PRESA BIPOLARE (CUCINA) / BASE BIPOLAR (TOMADA COZINHA)



**Bricofan**

25A / 250V  
MAX: 3680 W

Ref		A-V~			
5100 1040		25 A	1	10	5,62

ADAPTADOR MULTIVÍA 3 VÍAS ESPIGA Ø4 BIPOLARES / ADAPTATEUR MULIPRISE 3 PRISES / 3-WAY PLUG SOCKET  
ADATTATORE A 3 VIE / ADAPTADOR MULI-VIA 3 VIAS



**Bricofan**

10A / 250V  
MAX: 2300 W

Ref	VÍAS	A-V~	W MÁX			
5100 1028	3	10A-250V	2300 W	1	10	3,19

ADAPTADOR 3 VÍAS FRONTALES ESPIGA Ø4,8 BIPOLARES / ADAPTATEUR 3 PRISES FRONTALES / FRONT 3-WAY ADAPTER  
ADATTATORE A 3 VIE FRONTALI / ADAPTADOR 3 VIAS FRONTALIS



**Bricofan**

10A / 250V  
MAX: 3680 W

Ref	VÍAS	A-V~	W MÁX			
5100 1029	3	10A-250V	3680 W	1	10	3,61



ADAPTADOR SCHUKO 3 VÍAS / ADAPTATEUR SCHUKO / 3-WAY SCHUKO ADAPTER / SCHUKO ADATTATORE / ADAPTADOR SCHUKO 3 VIAS

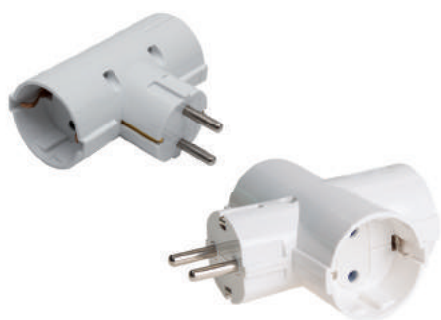

**Bricofan**

16A / 250V

MAX: 3500 W / 3680 W

Ref	VÍAS	A-V~	W MÁX			
5100 1031	2	16A-250V	3500 W	1	10	4,54
5100 1032	3	16A-250V	3680 W	1	10	4,78

ADAPTADOR FRONTAL SCHUKO 2 VÍAS / ADAPTATEUR FRONTAL / FRONT ADAPTER  
ADATTATORE FRONTALE / ADAPTADOR 2 VIAS FONTAL SCHUKO



**Bricofan**

16A / 250V

MAX: 3680 W

Ref	VÍAS	A-V~	W MÁX			
5100 1033	2	16A-250V	3680 W	1	10	4,16

ADAPTADOR 3 VÍAS FRONTAL SCHUKO CON INTERRUPTOR / ADAPTATEUR 3 VOIES FRONTAL SCHUKO AVEC INTERRUPTEUR  
3 WAY SCHUKO POWER STRIP (FRONTAL) WITH SWITCH / ADATTATORE MULTIPLO SCHUKO CON INTERRUTTORE  
ADAPTADOR 3 TOMADAS FRONTAL SCHUKO C/ INTERRUPTOR



**Bricofan**

16A / 250V

MAX: 3680 W

Ref	VÍAS	A-V~	W MÁX			
5100 1034	3	16A-250V	3680 W	1	10	5,68

ADAPTADOR ENCHUFE 1 TOMA FRONTAL + 2 USB / ADAPTATEUR 1 PRISE FRONTALE + 2 USB / SINGLE-GANG WALL SOCKET + DUAL USB PORT  
ADATTATORE SPINA 1 PRESA FRONTALE + 2 USB / ADAPTADOR 1 TOMADA FRONTAL +2 USB



**Bricofan**

→ 2 USB

Ref			
5100 1120	1	5	16,32



CLAVIJA MÓVIL INDUSTRIAL IP44 / CHEVILLE INDUSTRIELLE IP44 / INDUSTRIAL PLUG IP44 / SPINA INDUSTRIALE IP44 / FICHA INDUSTRIAL MACHO IP44

**Bricofan**

16A / 230V



Ref	A-V~					
5100 1291	16A-230V~	2P + T	1	10	6,28	✓

BASE MÓVIL INDUSTRIAL IP44 / BASE INDUSTRIELLE IP44 / INDUSTRIAL SOCKET IP44 / PRESA INDUSTRIALE IP44 / FICHA INDUSTRIAL FEMEA IP44

**Bricofan**

16A / 230V



Ref	A-V~					
5100 1292	16A-230V~	2P + T	1	10	9,47	✓

ADAPTADOR INDUSTRIAL IP44 CLAVIJA SCHUKO / ADAPTATEUR INDUSTRIEL 16A 230V IP44 CHEVILLE SCHUKO  
INDUSTRIAL ADAPTER 16A 230V IP44 SCHUKO PLUG / ADATTATORE INDUSTRIALE 16A 230V IP44 SPINA SCHUKO  
ADAPTADOR INDUSTRIAL 16A 230V IP44 FICHA MACHO SCHUKO

**Bricofan**

16A / 230V



Ref	A-V~					
5100 1293	16A-230V~	2P + T	1	10	23,49	✓

ADAPTADOR INDUSTRIAL CLAVIJA-BASE SCHUKO IP44 / ADAPTATEUR INDUSTRIEL CHEVILLE-BASE SCHUKO  
INDUSTRIAL ADAPTER IP44 SCHUKO SOCKET / ADATTATORE INDUSTRIALE SPINA-PRESA SCHUKO IP44  
ADAPTADOR INDUSTRIAL IP44 FICHA FEMEA SCHUKO

**Bricofan**

16A / 230V



Ref	A-V~					
5100 1294	16A-230V~	2P + T	1	10	26,73	✓



BASE CUADRADA SUPERFICIE + TOMA DE TIERRA / BASE CARRÉE SUPERFICIE + PRISE TERRE / SQUARE SOCKET + GROUND CONNECTION  
PRESA QUADRATA SUPERFICIE CON CONNESSIONE A TERRA / BASE QUADRADA SUPERFÍCIE + TOMADA TERRA



**Bricofan**



16A / 250 V

Ref	A-V~			
5100 1039	16A - 250V	1	10	3,85

INTERRUPTOR AÉREO / INTERRUPTEUR AIR / SWITCH / INTERRUTTORE / INTERRUPTOR AÉREO



**Bricofan**



4A / 250 V

Ref		A-V~			
5100 1080		4A-250V	1	10	1,85
5100 1081		4A-250V	1	10	1,85

PORTALÁMPARAS / PORTE-LAMPE / BULB SOCKET / PORTALAMPADA / SUPORTE LÂMPADAS

PORTALÁMPARAS CLASSIC / PORTE-LAMPE CLASIQUE / CLASSIC BULB SOCKET / PORTALAMPADA CLASSICA / SUPORTE LÂMPADAS CLASSIC



**Bricofan**



4A / 250 V

Ref		A-V~				
5100 1075		4A - 250V	E27	1	10	1,56

PORTALÁMPARAS PARA OBRA E-27 RESINA TERMOESTABLE BLANCO / PORTE-LAMPE POUR TRAVAUX E-27 4A250V RÉSINE THERMOSTABLE BLANC  
WHITE LAMP HOLDER FOR CONSTRUCTION SITE E-27 THERMOSETTING RESIN / PORTALAMPADA LAVORO E-27 RESINA TERMOSTABILE, BIANCA  
CASQUILHO P/ OBRA E-27 RESINA TERMOSTÁVEL BRANCO



**Bricofan**



4A / 250 V

Ref	A-V~			
5100 1241	4A-250V~	1	70	1,13

PORTALÁMPARAS PARED E27 / PORTE-LAMPE MUR / WALL BULB SOCKET / PORTALAMPADA A PARETE / SUPORTE LÂMPADAS PAREDE



**Bricofan**



E27

Ref					
5100 1073		E27	1	10	4,21



PORTALÁMPARAS DE FLUORESCENCIA FIJACIÓN PATILLAS ELÁSTICAS LATERALES / PORTE-LAMPE FLUORESCENTE FIXATION ÉLASTIQUES LATÉRAUX  
 FLUORESCENT LAMP HOLDER SNAP-IN SIDE CLIPS / PORTALAMPADA PER LAMPADE A FLUORESCENZA FISSAGGIO TRAMITE ALETTE LATERAL  
 CASQUILHOS DE FLUORESCÊNCIA APERTOS ELÁSTICOS LATERAIS



**Bricofan**

2A / 250V



Ref	A-V~			
5100 1242	2A-250V~	1	10	1,44

PORTALÁMPARAS DE FLUORESCENCIA CON PORTACEBADOR / PORTE-LAMPE FLUORESCENT AVEC SUPPORT STARTER  
 FLUORESCENT LAMP HOLDER WITH STARTER HOLDER / PORTALAMPADA PER LAMPADE A FLUORESCENZA CON SUPPORTO  
 CASQUILHOS DE FLUORESCÊNCIA APERTO RÁPIDO



**Bricofan**

2A / 250V



Ref	A-V~			
5100 1243	2A-250V~	1	60	2,31

PORTALÁMPARAS ADAPTADOR GU10 / PORTE-LAMPE ADAPTATEUR / LAMP HOLDER ADAPTER / ADATTATORE PER LAMPADINA / CASQUILHOS ADAPTADOR  
**E27**                      **E14**



**Bricofan**

Ref				
5100 1244	E14 - GU10	1	12	3,10
5100 1245	E27 - GU10	1	12	3,10

PORTALÁMPARAS ADAPTADOR E27 A E14 / PORTALAMPARAS ADAPTADOR E27 - E14 / LAMP HOLDER ADAPTER E27 - E14  
 ADATTATORE PER LAMPADINA E27 - E14 / CASQUILHOS ADAPTADOR



**Bricofan**

E14/ E27

Ref				
5100 1246	E14 - E27	1	12	2,62

PORTALÁMPARAS CERÁMICA CON CASQUILLO Y CABLE / PORTE-LAMPE CÉRAMIQUE AVEC DOUILLE ET CÂBLE  
 CERAMIC LAMP HOLDER WITH LAMP HOLDER AND CABLE / PORTALAMPADA IN CERAMICA CON CAVO  
 CASQUILHOS CERÂMICA COM CASQUILHO E CABO



**Bricofan**

GU10 - GZ10  
 2A / 250 V

Ref	↔	A-V~			
5100 1247	150 mm	2A-250V~	1	100	0,82





DIGITAL / DIGITAL / DIGITAL / DIGITALE / DIGITAL



ES Enchufable. Electrónico digital fácil de programar. Con programa diario y semanal en el mismo aparato. Puede activar 20 programaciones diferentes. Maniobra mínima 1 min. Reserva de carga: 150 horas mediante acumulador incorporado.

FR Branchement secteur. Electronique digital facile à programmer. Programme quotidien et hebdomadaire sur le même appareil. Il peut activer 20 programmes différents. Manipulation minimum 1 min. Réserve de charge : 150 heures par accumulateur intégré.

EN Pluggable. Digital electronic system easy to set up. With daily and weekly program in the equipment. 20 different programming can be activated. Minimum set up time 1 min. Charging reserve: 150 hours using built-in battery.

IT Collegabile. Elettronico, digitale, facile da programmare. Con programma giornaliero e settimanale nella stessa apparecchiatura. 20 programmazione diverse possono essere attivati. Minimo programmabile: 1 min. Carica di riserva: 150 ore mediante accumulatore incorporato.

PT Com tomada elétrica. Eletrônico digital, fácil de programar. Com programa diário e semanal no mesmo aparelho. Pode ativar 20 programações diferentes. Manobra mínima 1 min. Reserva de carga: 150 horas usando bateria interna.

Ref	A	W	V-HZ					
5100 1070	16 A	3680 W	230 V 50 Hz	218 x 100 x 100 mm	189 g	1	5	27,26

ANALÓGICO / ANALOGIQUE / ANALOGUE / ANALOGICO / ANALÓGICO



ES Enchufable. Esfera analógica. Programación por segmentos. Fácil programación y visualización. Programa diario, maniobra mínima 15 minutos. Carga resistiva.

FR Branchement secteur. Sphère analogique. Programmation par segments. Programmation et visualisation faciles. Programme quotidien, Manipulation minimum 15 minutes. Charge résistive.

EN Pluggable. Analogue dial system. Programming segments. Easy to set up and display. Daily program, minimum set up time 15 minutes. Resistive load.

IT Collegabile. Quadrante analogico. Programmazione per segmenti. Facile programmazione e visualizzazione. Programma giornaliero. Minimo programmabile: 15 minuti. Carico resistivo.

PT Com tomada elétrica. Marcação analógica. Programação por segmentos. Fácil programação e visualização. Programa diário, 15 minutos manobra mínima. Carga resistiva.

Ref	A	W	V-AC-HZ					
5100 1071	16 A	1800W	230-240V AC 50 Hz	193 x 88 x 80 mm	133 g	1	5	12,84

### TERMOSTATO CALEFACCIÓN / THERMOSTAT DE CHAUFFAGE / HEATING THERMOSTAT TERMOSTATO RISCALDAMENTO / TERMOSTATO DE AQUECIMENTO

DIGITAL / DIGITAL / DIGITAL / DIGITALE / DIGITAL



10°C - 30°C

ES Cronotermostato digital con regulación de temperatura manual y oscilación de 10 a 30°C.

FR Chronothermostat numérique avec contrôle manuel de la température et oscillation de 10 à 30°C.

EN Digital programmable thermostat with manual temperature control and variation from 10 to 30°C.

IT Cronotermostato digitale con regolazione manuale e oscillazione della temperatura da 10 al 30°C.

PT Cronotermostato digital com regulação de temperatura manual e oscilação de 10 a 30°C.

Ref			
5100 1119	1	6	52,72

ANALÓGICO / ANALOGIQUE / ANALOGUE / ANALOGICO / ANALÓGICO



5°C - 35°C

ES Cronotermostato analógico con regulación de temperatura manual y oscilación de 5° a 35°C.

FR Chronothermostat analogique avec contrôle manuel de la température et oscillation de 5° à 35°C.

EN Analogue programmable thermostat with manual temperature control and variation from 5 to 35°C.

IT Cronotermostato analogico con regolazione manuale e oscillazione della temperatura da 10 al 30°C.

PT Cronotermostato analógico com regulação de temperatura manual e oscilação de 5°.

Ref			
5100 1118	1	10	24,28



DETECTOR MINI DE HUMOS CON ALARMA SONIDO / MINI DETECTEUR DE FUMÉE AVEC ALARME SONORE  
 MINI SMOKE DETECTOR WITH WARNING ALARM / RILEVATORE MINI DI FUMO CON ALLARME SONORO  
 MINI DETECTOR DE FUMOS C/ ALARME SONORO

**Bricofan**

ES Detector de humo mini con pilas incluidas e indicador LED de aviso de funcionamiento de batería.

FR Mini détecteur de fumée avec piles incluses et LED d'avertissement de fonctionnement des piles.

EN Mini smoke detector supplied with batteries and a LED warning lamp for a proper battery run.

IT Rilevatore di fumo mini fornito con batterie e lampada spia LED di funzionamento della batteria.

PT Mini Detetor de fumos com pilas incluídas e LED de aviso de funcionamento da bateria.

Ref	Ø			
5100 1115	70 mm	1	4	25,74

DETECTOR DE HUMOS CON ALARMA SONIDO / DETECTEUR DE FUMÉE AVEC ALARME SONORE / SMOKE DETECTOR WITH WARNING ALARM  
 RILEVATORE DI FUMO CON ALLARME SONORO / DETECTOR DE FUMOS C/ ALARME SONORO

**Bricofan**

ES Detector de humo con pilas incluidas e indicador LED de aviso de funcionamiento de batería.

FR Détecteur de fumée avec piles incluses et LED d'avertissement de fonctionnement des piles.

EN Smoke detector supplied with batteries and a LED warning lamp for a proper battery run.

IT Rilevatore di fumo fornito con batterie e lampada spia LED di funzionamento della batteria.

PT Mini Detetor de fumos com pilas incluídas e LED de aviso de funcionamento da bateria.

Ref	Ø			
5100 1116	100 mm	1	4	16,73

DETECTOR DE INUNDACIÓN CON ALARMA SONIDO / DETECTEUR D'INONDATION AVEC ALARME SONORE / FLOOD DETECTOR WITH WARNING ALARM  
 RILEVATORE DI INONDAZIONE CON ALLARME SONORO / DETECTOR DE INUNDAÇÕES C/ ALARME SONORO

**Bricofan**

ES Detector de inundación portátil con pila incluida y led de aviso de funcionamiento de batería.

Détecteur d'inondation portable avec pile incluse et LED d'avertissement de fonctionnement de la pile.

EN Portable flood sensor supplied with batteries and a LED warning lamp for a proper battery run.

IT Rilevatore di inondazioni portatile fornito con batterie e lampada spia LED di funzionamento della batteria.

Detetor de inundações com pilas incluídas e LED de aviso de funcionamento da bateria.

Ref	Ø			
5100 1117	80 mm	1	4	19,33



PULSADOR ESTANCO IP54 / BOUTON ÉTANCHE IP54 / IP54 WATERTIGHT PUSH BUTTON  
INTERRUTTORE IMPERMEABILE IP54 / BOTÃO ESTANQUE IP54



**Bricofan**

10A / 250 V



Ref	A-V~				
5100 1222	10A-250V~	1	10	5,68	✓

CONMUTADOR ESTANCO IP44 / COMMUTEUR ÉTANCHE IP44 / WATERTIGHT COMMUTATOR IP44  
COMMUTATORE PER ESTERNO IP44 / COMUTADOR ESTANQUE IP44

L-N



**Bricofan**

10A / 250 V

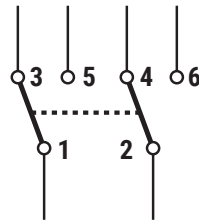

Ref	A-V~				
5100 1223	10A-250V~	1	10	5,68	✓

BASE ENCHUFE ESTANCO IP44 / BASE PRISE ÉTANCHE IP44 / WATERPROOF BASE SWITCH IP44  
PRESA PER ESTERNO IP44 / TOAMDA FÊMEA ESTANQUE IP44

**Bricofan**

16A / 250 V

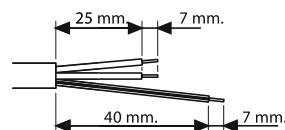

Ref	A-V~				
5100 1226	16A-250V~	1	20	5,47	✓



INTERRUPTOR-COMUTADOR EMPOTRAR / INTERRUPTEUR-COMMUTATEUR ENCASTRER / WALL-MOUNTED SWITCH  
INTERRUTTORE AD INCASSO / INTERRUPTOR-COMUTADOR EMBUTIR



**Bricofan**

MOD. PACIFIC  
10A / 250 V

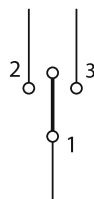

Ref	A-V~				
5100 1201	10A-250V	1	10	6,78	✓

PULSADOR EMPOTRAR BLANCO / BOUTON ENCASTRER BLANC / WALL-MOUNTED DIMMER SWITCH WHITE  
INTERRUTTORE AD INCASSO BIANCO / BOTÃO EMBUTIR BRANCO



**Bricofan**

MOD. PACIFIC  
10A / 250 V



Ref	A-V~				
5100 1202	10A-250V	1	10	6,78	✓

COMUTADOR. CRUZAMIENTO EMPOTRAR BLANCO / COMM. CROISEMENT ENCASTRER / WALL-MOUNTED CROSSOVER SWITCH WHITE  
INTERRUTTORE AD INCASSO / COMUTADOR CRUZAMENTO EMBUTIR



**Bricofan**

MOD. PACIFIC  
10A / 250 V

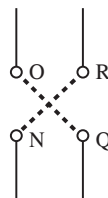

Ref	A-V~				
5100 1203	10A-250V	1	10	9,53	✓

REGULADOR EMPOTRAR BLANCO 500W / REGULATEUR ENCASTRER 500W BLANC / WALL-MOUNTED DIMMER SWITCH 500W WHITE  
REGOLATORE AD INCASSO 500W BIANCO / REGULADOR EMBUTIR 500W BRANCO



**Bricofan**

MOD. PACIFIC  
16A / 250 V



Ref	A-V~				
5100 1204	800W-250V~	1	10	32,98	✓



DOBLE INTERRUPTOR-CONMUTADOR EMPOTRAR BLANCO / DOUBLE INTERRUPTEUR COMMULATEUR ENCASTRER  
 WALL-MOUNTED DOUBLE SWITCH WHITE / DOPPIO INTERRUTTORE AD INCASSO / INTERRUPTOR-COMUTADOR DUPLO EMBUTIR



MOD. PACIFIC  
 10A / 250 V

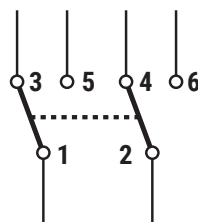

Ref	A-V~				
5100 1205	10A-250V	1	10	9,62	✓

BASE ENCHUFE BIPOLAR EMPOTRAR BLANCO / BASE PRISE BIPOLAIRE ENCASTRER / 2-PIN WALL-MOUNTED SOCKET BASE WHITE  
 PRESA ELETTRICA BIPOLARE AD INCASSO / BASE TOMADA BIPOLAR EMBUTIR



MOD. PACIFIC  
 16A / 250 V  
 L-N

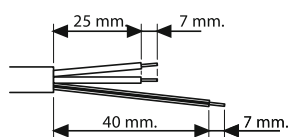

Ref	A-V~				
5100 1206	16A-250V~	1	10	7,17	✓

TOMA TV/RADIO EMPOTRAR BLANCO / PRISE TV/RADIO ENCASTRER BLANC / WALL-MOUNTED TV/RADIO SOCKET WHITE  
 PRESA TV/RADIO AD INCASSO BIANCA / TOMADA TV/RÁDIO EMBUTIR BRANCA



MOD. PACIFIC



Ref				
5100 1207	1	10	18,20	✓

BASE TELÉFONO EMPOTRAR BLANCA / BASE TÉLÉPHONE ENCASTRER BLANCHE / WALL-MOUNTED TELEPHONE SOCKET WHITE  
 PRESA TELEFONICA AD INCASSO BIANCA / TOMADA TELEFONE EMBUTIR BRANCA



MOD. PACIFIC  
 RJ 11



Ref				
5100 1208	1	10	11,34	✓





BASE DOBLE BIPOLAR CON OBTURADOR Y EMBORNAMIENTO POR TORNILLO / BASE DOUBLE BIPOLAIRE AVEC OPTURATEUR ET BORNAGE A VIS  
 2-GANG DOUBLE PIN BASE WITH CLIP AND CONNECTION BY SCREW / PRESA DOPPIA BIPOLARE CON OTTURATORE E BORDO A VITE  
 TOMADA DUPLA BIPOLAR C/ OBTURADOR E CONEXÃO POR PARAFUSO



**Bricofan**

**MOD. PACIFIC**  
**16A / 250V**



Ref	A-V~				
5100 1231	16A-250V~	1	10	7,69	✓

TOMA FINAL TV-SATÉLITE-RADIO BLANCO 83x81 / PRISE FINALE TV-SATELLITE-RADIO 83X81 BLANC / TV-SATELLITE-RADIO SOCKET 83X81 WHITE  
 PRESA TV-SATELLITE-RADIO, MOD. PACIFIC 83X81 BIANCA / TOMADA FINAL TV-SATÉLITE-RÁDIO 83X81 BRANCA



**Bricofan**

**MOD. PACIFIC**



Ref				
5100 1232	1	10	31,53	✓

BASE ENCHUFE 2P+T CON OBTURADOR ENTRADA USB / BASE PRISE 2P+T AVEC OPTURATEUR ENTREE USB / 2P+E SOCKET BASE WITH CLIP USB PORT  
 PRESA SCHUKO 2P+T CON OTTURATORE INGRESSO PORTA USB / BASE TOMADA 2P+T C/ OBTURADOR ENTRADA USB

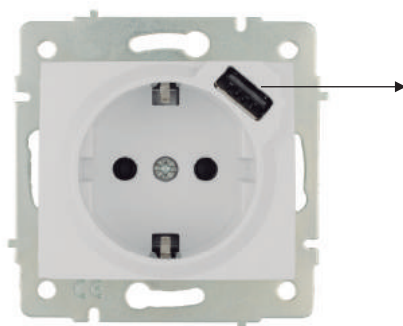

**Bricofan**

**MOD. PACIFIC**  
**USB**  
**16A / 250V**



Ref	A-V~				
5100 1235	16A-250V	1	10	26,69	✓

BASE ENCHUFE USB MONOBLOC 2P+T CON OBTURADOR 2,1A-5V / BASE PRISE USB MONOBLOC 2P+T AVEC OPTURATEUR  
 SOCKET BASE USB MONOBLOCK 2P+E WITH CLIP / PRESA SCHUKO MONOBLOCCO CON USB, MOD. PACIFIC 2P+T CON OTTURATORE  
 BASE TOMADA USB MONOBLOC 2P+T C/ OBTURADOR



**Bricofan**

**MOD. PACIFIC**  
**USB**  
**16A / 250V**



Ref	A-V~				
5100 1236	16A-250V~	1	10	27,82	✓



MARCO DE MECANISMOS BLANCO / PLAQUE POUR MECANISME BLANC / WHITE WALL PLATE FRAMES  
 MARCHI MECCANISMI BIANCO / MARCOS DE MECANISMOS BRANCO



**Bricofan**



MOD. PACIFIC

Ref					
5100 1361	1 ELEMENTO	85 x 85 x 20	1	1,22	✓



**Bricofan**



Ref					
5100 1362	2 ELEMENTOS	155 x 85 x 20	1	3,14	✓



**Bricofan**



Ref					
5100 1363	3 ELEMENTOS	225 x 85 x 20	1	4,53	✓

MARCO DE MECANISMOS NEGRO / PLAQUE POUR MECANISME NOIRE / BLACK WALL PLATE FRAMES  
 MARCHI MECCANISMI NERO / MARCOS DE MECANISMOS PRETO



**Bricofan**



MOD. PACIFIC

Ref					
5100 1364	1 ELEMENTO	85 x 85 x 20	1	3,18	✓



**Bricofan**



Ref					
5100 1365	2 ELEMENTOS	155 x 85 x 20	1	6,38	✓



**Bricofan**



Ref					
5100 1366	3 ELEMENTOS	225 x 85 x 20	1	8,78	✓



CONMUTADOR-INTERRUPTOR SUPERFICIE BLANCO 10A / COMMUTATEUR-INTERRUPTEUR SURFACE 10A BLANC  
 SURFACE-MOUNTED SWITCH 10A WHITE / INTERRUTTORE A VISTA 10A BIANCO / COMUTADOR-INTERRUPTOR SUPERFÍCIE 10A BRANCO



**Bricofan**  
 MOD. ATLANTIS  
 10A / 250V

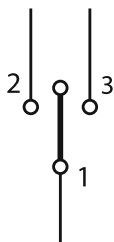

Ref	A-V~				
5100 1211	10A-250V~	1	10	4,82	✓

PULSADOR CAMPANA SUPERFICIE BLANCO 10A / BOUTON CAMPANA SURFACE 10A BLANC / SURFACE-MOUNTED PUSH BUTTON SWITCH 10A WHITE  
 INTERRUTTORE CAMPANELLO A VISTA 10A BIANCO / BOTÃO CAMPAINHA SUPERFÍCIE 10A BRANCO



**Bricofan**  
 MOD. ATLANTIS  
 10A / 250V

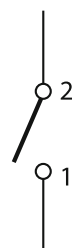

Ref	A-V~				
5100 1212	10A-250V~	1	10	4,90	✓

BASE BIPOLAR SUPERFICIE BLANCO 16A / BASE BIPOLAIRE SURFACE 16A BLANC / SURFACE-MOUNTED DOUBLE PIN BASE 16A. WHITE  
 PRESA BIPOLARE A VISTA 16A, BIANCA / TOMADA BIPOLAR SUPERFÍCIE 16A. BRANCO



**Bricofan**  
 MOD. ATLANTIS  
 16A / 250V  
 L-N

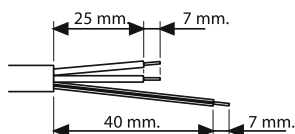

Ref	A-V~				
5100 1216	16A-250V~	1	10	5,95	✓



DOBLE INTERRUPTOR SUPERFICIE BLANCO 10A / DOUBLE INTERRUPTEUR SURFACE 10A BLANC / SURFACE-MOUNTED DOUBLE SWITCH 10A WHITE  
 DOPPIO INTERRUOTTORE A VISTA 10A BIANCO / INTERRUPTOR DUPLO SUPERFÍCIE 10A BRANCO



**Bricofan**  
 MOD. ATLANTIS  
 10A / 250V

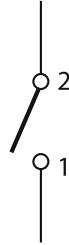

Ref	A-V~				
5100 1217	10A-250V~	1	10	5,98	✓

BASE TELÉFONO RJ11 SUPERFICIE BLANCO / BASE TÉLÉPHONE RJ11 SURFACE BLANC MOD. ATLANTIS / TELEPHONE SOCKET SURFACE RJ11 WHITE  
 PRESA TELEFONICA A VISTA, RJ11 BIANCA / TOMADA TELEFONE RJ11 SUPERFÍCIE BRANCA



**Bricofan**  
 MOD. ATLANTIS  
 10A / 250V



Ref	A-V~				
5100 1218	10A-250V~	1	10	5,46	✓

CONMUTADOR DE CRUCE / COMMUTATEUR DE CROISEMENT / CROSSOVER SWITCH / INTERRUTTORE / COMUTADOR CRUZAMENTO



**Bricofan**  
 MOD. ATLANTIS  
 10A / 250V

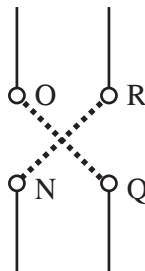

Ref	A-V~				
5100 1233	10A-250V	1	10	4,97	✓



CAJA DE EMPOTRAR MECANISMOS TUBO / BOITIER A ENCASTRER MÉCANISMES UNIVERSEL / UNIVERSAL WALL BACK BOX 5-GANG TUBE  
CONTENITORE UNIVERSALE AD INCASTRO PER MECCANISMI / CAIXA ENCASTRAR APARELHAGEM UNIVERSAL



**Bricofan**

Ref					
5100 1271	5 ENTRADAS	64 x 77 x 42 mm	1	20	0,48



Ref					
5100 1272	6 ENTRADAS	145 x 67 x 42 mm	1	10	1,91



Ref					
5100 1273	8 ENTRADAS	217 x 67 x 46 mm	1	10	2,53



Ref					
5100 1274	4 ENTRADAS	Ø68 x 46 mm	1	20	1,39



Ref					
5100 1277	9 ENTRADAS	65 x 65 x 40 mm	1	20	0,38

CAJA DOBLE DE EMPOTRAR MECANISMOS TUBO / CAJA DOBLE EMPOTRAR MECANISMOS / DOUBLE WALL BACK BOX  
CONTENITORE DOPPIO AD INCASTRO PER MECCANISMI / CAIXA DUPLA ENCASTRAR APARELHAGEM

**Bricofan**



Ref					
5100 1275	8 ENTRADAS	140 x 68 x 46 mm	1	10	2,84

CAJA TRIPLE DE EMPOTRAR MECANISMOS TUBO Ø20/25mm / BOITIER TRIPLE ENCASTRER MÉCANISMES / TRIPLE WALL BACK BOX  
CONTENITORE TRIPLO AD INCASTRO, PER MECCANISMI / CAIXA TRIPLA ENCASTRAR APARELHAGEM

**Bricofan**



Ref						
5100 1276	10 ENTRADAS	20/25 mm	218 x 68 x 42 mm	1	6	4,32





ZÓCALO SUPERFICIE BLANCO PARA MECANISMOS VARIADOS / SOCLE SURFACE POUR 1 ELEMENT BLANC / 1-GANG SURFACE BACK BOX WHITE  
BATTISCOPA PER 1 ELEMENTO BIANCO / SOQUETE SUPERFICIE PARA 1 ELEMENTO BRANCO



**Bricofan**

Ref				
5100 1281	1 ELEMENTO	94 x 96 x 43 mm	1	2,88



**Bricofan**

Ref				
5100 1282	2 ELEMENTOS	165 x 96 x 43 mm	1	4,41



**Bricofan**

Ref				
5100 1283	3 ELEMENTOS	253 x 96 x 43 mm	1	5,46

CANAL ADHESIVO PARA SUELO / CANAL ADHÉSIF POUR LE SOL / SELF-ADHESIVE MINI TRUNKING FOR FLOOR  
CANALINA ADESIVA PER PAVIMENTO / CALHA ADESIVA PARA SOLO



**Bricofan**

Ref				
5100 1309	2 m	8 x 50 mm	3	15,02
5100 1310	2 m	9 x 60 mm	3	17,47
5100 1311	2 m	15 x 90 mm	3	25,50

MINICANAL RECTO ADHESIVO RAL 9003 IP40 - PUC (M1) / MINICANAL DROIT ADHÉSIF 2M 7X12 / STRAIGHT SELF-ADHESIVE MINI TRUNKING 2M 7X12  
CANALINA ADESIVA 2M 7X12 / MINI CALHA RETA ADESIVA 2M 7X12



**Bricofan** UNE-EN 5008-1 // DIRECTIVA 2014/35/UE // CONFORME REBT

Ref		mm <sup>2</sup>			
5100 1301	2 m	52	7 x 12 mm	10	4,45
5100 1302	2 m	104	10 x 16 mm	10	5,94
5100 1303	2 m	136	10 x 20 mm	7	6,64
5100 1304	2 m	94	12 x 12 mm	6	6,46
5100 1305	2 m	182	16 x 16 mm	6	6,64
5100 1306	2 m	308	16 x 25 mm	4	11,09
5100 1307	2 m	480	25 x 25 mm	3	13,19
5100 1308	2 m	793	25 x 40 mm	3	18,35

ÁNGULO EXTERIOR / ANGLE EXTÉRIEUR / EXTERIOR ANGLE / ANGOLO ESTERNO / ÂNGULO EXTERIOR



**Bricofan** UNE-EN 5008-1 // DIRECTIVA 2014/35/UE // CONFORME REBT

Ref				
5100 1312	7 x 12 mm	5	30	0,74
5100 1313	10 x 16 mm	5	30	0,74
5100 1314	10 x 20 mm	5	25	0,78
5100 1315	12 x 12 mm	5	40	0,74
5100 1316	16 x 16 mm	5	25	0,78
5100 1317	16 x 25 mm	5	20	1,09
5100 1318	25 x 40 mm	5	20	1,75



ÁNGULO INTERIOR / ANGLE INTÉRIEUR 7X12 / EXTERIOR ANGLE 7X12 / ANGOLO INTERNO 7X12 / ÂNGULO INTERIOR 7X12



**Bricofan** UNE-EN 5008-1 // DIRECTIVA 2014/35/UE // CONFORME REBT

Ref				
5100 1319	7 x 12 mm	5	30	<b>0,74</b>
5100 1320	10 x 16 mm	5	30	<b>0,74</b>
5100 1321	10 x 20 mm	5	30	<b>0,78</b>
5100 1322	12 x 12 mm	5	30	<b>0,74</b>
5100 1323	16 x 16 mm	5	25	<b>0,78</b>
5100 1324	16 x 25 mm	5	25	<b>1,09</b>
5100 1325	25 x 40 mm	5	20	<b>1,75</b>

ÁNGULO PLANO / ANGLE PLAT 7X12 / PLAIN ANGLE 7X12 / ANGOLO PIATTO 7X12 / ÂNGULO PLANO 7X12



**Bricofan** UNE-EN 5008-1 // DIRECTIVA 2014/35/UE // CONFORME REBT

Ref				
5100 1326	7 x 12 mm	5	30	<b>0,74</b>
5100 1327	10 x 16 mm	5	30	<b>0,74</b>
5100 1328	10 x 20 mm	5	40	<b>0,78</b>
5100 1329	12 x 12 mm	5	40	<b>0,74</b>
5100 1330	16 x 16 mm	5	5	<b>0,78</b>
5100 1331	16 x 25 mm	5	20	<b>1,09</b>
5100 1332	25 x 40 mm	5	20	<b>1,75</b>

DERIVACIÓN EN T / DÉRIVATION EN T / CABLE TRUNKING FLAT TEE / DEVIAZIONE A T PER CANALINA / DERIVAÇÃO EN T



**Bricofan** UNE-EN 5008-1 // DIRECTIVA 2014/35/UE // CONFORME REBT

Ref				
5100 1333	7 x 12 mm	5	20	<b>0,74</b>
5100 1334	10 x 16 mm	5	24	<b>0,74</b>
5100 1335	10 x 20 mm	5	25	<b>0,78</b>
5100 1336	12 x 12 mm	5	30	<b>0,74</b>
5100 1337	16 x 16 mm	5	5	<b>0,78</b>
5100 1338	16 x 25 mm	5	15	<b>1,09</b>
5100 1339	25 x 40 mm	5	20	<b>1,75</b>

TAPA FINAL / BOUCHON 7X12 / END COVER / TAPPO CHIUSURA / TAMPA FINAL



**Bricofan** UNE-EN 5008-1 // DIRECTIVA 2014/35/UE // CONFORME REBT

Ref				
5100 1340	7 x 12 mm	5	75	<b>0,74</b>
5100 1341	10 x 16 mm	5	100	<b>0,74</b>
5100 1342	10 x 20 mm	5	50	<b>0,78</b>
5100 1343	12 x 12 mm	5	50	<b>0,74</b>
5100 1344	16 x 16 mm	5	5	<b>0,78</b>
5100 1345	16 x 25 mm	5	50	<b>1,09</b>
5100 1346	25 x 40 mm	5	40	<b>1,75</b>

UNIÓN / RACCORD UNION / JOINT / UNIONE / UNIÃO



**Bricofan** UNE-EN 5008-1 // DIRECTIVA 2014/35/UE // CONFORME REBT

Ref				
5100 1347	7 x 12 mm	5	50	<b>0,74</b>
5100 1348	10 x 16 mm	5	50	<b>0,74</b>
5100 1349	10 x 20 mm	5	50	<b>0,78</b>
5100 1350	12 x 12 mm	5	50	<b>0,74</b>
5100 1351	16 x 16 mm	5	5	<b>0,78</b>
5100 1352	16 x 25 mm	5	40	<b>1,09</b>
5100 1353	25 x 40 mm	5	20	<b>1,75</b>



CAJA DE SUPERFICIE TAPA REDONDA Y ROSCADA / BOITIER DE SURFACE TUBE COUVERCLE ROND ET FILETÉ  
 SURFACE BOX THREADED AND ROUND LID / CONTENITORE A VISTA COPERCHIO ROTONDO E FILETTATO  
 CAIXA DE SUPERFICIE TAMPA REDONDA E ROSCADA



ES 4 entradas de tubo Ø20 y 4 entradas en el fondo para tubo Ø18.  
 FR 4 entrées de tube Ø20 et 4 entrées dans le fond pour le tube Ø18.  
 EN 4 gangs for Ø20 tube and 4 gangs at the back for Ø18 tube.  
 IT 4 ingressi tubo Ø20 e 4 ingressi sulla parte inferiore per tubo Ø18.  
 PT 4 entradas de tubo Ø20 e 4 entradas no fundo para tubo Ø18.

Ref				
5100 1284	4 ENTRADAS	80,5 x 32 mm	1	<b>2,44</b>
5100 1285	4 ENTRADAS	106 x 37 mm	1	<b>3,01</b>

CAJA ESTANCA CON CONOS CIERRE CON TAPA A PRESIÓN / BOITIER ÉTANCHE AVEC CÔNES FERMETURE AVEC COUVERCLE A PRESSION  
 WATERTIGHT BOX WITH CONES CLOSURE BY PRESSURE SEALING / CONTENITORE IMPERMEABILE CON COPERCHIO A PRESSIONE  
 CAIXA ESTANQUE C/ CONES FECHO C/ TAMPA A PRESSÃO



ES Con 4 orificios para prensaestopa M20.  
 FR 4 orifices pour presse-étoupe M20.  
 EN 4 gaps for M20 stuffing box.  
 IT Con 4 fori per pressacavo M20.  
 PT Com 4 orificios para glândulas de cabos M20.

Ref		IP		
5100 1286	Ø70 x 35 mm	55	1	<b>2,75</b>

TAPA CON GARRA METÁLICA PARA CAJA DE 6 ENTRADAS DE TUBO Ø32 / COUVERCLE AVEC GRIFFE MÉTALLIQUE  
 BLANK UP COVER WITH METAL HOOK / COPERCHIO CON GANCIO METALLICO / TAMPA C/ GARRA METÁLICA



Ref			
5100 1287	106 x 37 mm	1	<b>1,35</b>

TAPA ROSCADA PARA CAJA EMPOTRAR DE TUBO Ø25 / COUVERCLE FILETE POUR BOITIER A ENCASTRER  
 THREADED BLANK UP COVER FOR WALL-MOUNTED BOX / COPERCHIO FILETTATO PER CONTENITORE AD INCASSO  
 TAMPA ROSCADA P/ CAIXA ENCASTRADA



Ref			
5100 1288	80 x 32 mm	1	<b>0,52</b>



CABLE ELÉCTRICO / CÂBLE ELECTRIQUE / ELECTRICAL CABLE / CAVO ELETTRICO / CABO ELÉTRICO

**Bricofan**

100 m



	Ref					
	5100 2615	PARALELO	2 x 1,5 mm <sup>2</sup>	100 m	1	94,96
	5100 2675	PARALELO	2 x 0,75 mm <sup>2</sup>	100 m	1	53,98
	5100 2554A	H07V-K	1 x 1,5 mm <sup>2</sup>	100 m	1	44,54
	5100 2564A	H07V-K	1 x 2,5 mm <sup>2</sup>	100 m	1	73,83
	5100 4010A	H07V-K	1 x 6 mm <sup>2</sup>	100 m	1	174,21
	5100 2554N	H07V-K	1 x 1,5 mm <sup>2</sup>	100 m	1	44,54
	5100 2564N	H07V-K	1 x 2,5 mm <sup>2</sup>	100 m	1	73,83
	5100 4010N	H07V-K	1 x 6 mm <sup>2</sup>	100 m	1	174,21
	5100 2554V	H07V-K	1 x 1,5 mm <sup>2</sup>	100 m	1	44,54
	5100 2564V	H07V-K	1 x 2,5 mm <sup>2</sup>	100 m	1	73,83
	5100 4010V	H07V-K	1 x 6 mm <sup>2</sup>	100 m	1	174,21
	5100 2554M	H07V-K	1 x 1,5 mm <sup>2</sup>	100 m	1	44,54
	5100 2564M	H07V-K	1 x 2,5 mm <sup>2</sup>	100 m	1	73,83
	5100 4010M	H07V-K	1 x 6 mm <sup>2</sup>	100 m	1	174,21
	5100 2554G	H07V-K	1 x 1,5 mm <sup>2</sup>	100 m	1	44,54
	5100 2564G	H07V-K	1 x 2,5 mm <sup>2</sup>	100 m	1	73,83
	5100 4010G	H07V-K	1 x 6 mm <sup>2</sup>	100 m	1	174,21
	5100 2554R	H07V-K	1 x 1,5 mm <sup>2</sup>	100 m	1	44,54
	5100 3002	PVC H05VV-F	2 x 1 mm <sup>2</sup>	100 m	1	91,16
	5100 3010	PVC H05VV-F	3 x 1 mm <sup>2</sup>	100 m	1	118,53
	5100 3015	PVC H05VV-F	3 x 1,5 mm <sup>2</sup>	100 m	1	167,26
	5100 3025	PVC H05VV-F	3 x 2,5 mm <sup>2</sup>	100 m	1	272,03

**MATERIAL ELÉCTRICO / MATERIEL ELECTRIQUE  
ELECTRICAL EQUIPMENT / MATERIALE ELETTRICO / MATERIAL ELÉTRICO**

SURTIDO TUBOS TERMORETRÁCTILES 80 MM / ASSORTIMENT TUBES THERMORETRACTABLES 80 MM / ASSORTMENT HEAT SHRINK TUBES 80 MM  
ASSORTIMENTO TUBI TERMORETRAIBILI 80 MM / SORTIDO TUBOS TERMO RETRÁCTEIS 80 MM



**Bricofan**

Ref	PACK		
5100 1261	10 uds	1	0,92



**Bricofan**

Ref	PACK		
5100 1262	18 uds	1	1,09

ABRAZADERA MULTIUSOS / COLLIERS À USAGES MULTIPLES / MULTIPURPOSE HOSE CLAMP / FASCETTA MULTIUSO / ABRAÇADEIRA MULTIUSOS



- ES Fijación por presión. Con pre-rosca M6 y cierre rápido. Para sujetar tuberías ligeras de acero, cobre, plástico y cable. Para tuberías desde Ø15 mm hasta Ø28 mm.
- FR Fixation par pression. Avec pre-filetage M6 et fermeture rapide. Pour tenir des tuyaux légers en acier, cuivre, plastique et câbles. Pour tubes de Ø15 mm jusqu'à Ø28 mm.
- EN Pressure mount system. With pre-thread M6 & quick closure. It is intended for holding steel, copper, plastic steam tubes and cables. It is suitable for tubes from Ø15 mm to Ø28 mm.
- IT Montaggio a pressione. Con filettati pre-foro M6 e chiusura rapida. È adatto per contenere tubi leggeri in acciaio, rame, plastica e cavi. È idoneo per tubi da Ø15 mm al Ø28 mm.
- PT Fixação por pressão. Com pré-rosca M6 e fecho rápido. Para prender tubagens leves de aço, cobre, plástico e cabo. Para tubagens desde Ø15mm até Ø28mm.

Ref	Ø	Kg		
5100 1263	12 mm	40	100	<b>0,19</b>
5100 1264	15 mm - 16 mm	40	100	<b>0,18</b>
5100 1265	18 mm - 20 mm	40	50	<b>0,23</b>
5100 1266	22 mm - 25 mm	40	50	<b>0,27</b>
5100 1267	26 mm - 28 mm	40	50	<b>0,34</b>
5100 1268	32 mm - 35 mm	40	25	<b>0,44</b>
5100 1269	40 mm - 42 mm	40	25	<b>0,58</b>
5100 1270	48 mm - 50 mm	40	25	<b>0,73</b>

GRAPA PLÁSTICO CABLE PLANO / AGRAFE PLASTIQUE CÂBLE PLAT / FLAT PLASTIC CABLE CLAMP  
FISSATORE IN PLASTICA, PIATTO / GRAMPO PLÁSTICO CABO PLANO



Ref			
5100 1090	3,9 x 2,2 mm	200	<b>0,09</b>
5100 1091	5,4 x 3,3 mm	200	<b>0,11</b>
5100 1092	7,3 x 4,1 mm	200	<b>0,11</b>
5100 1093	9,3 x 5 mm	200	<b>0,11</b>

GRAPA PLÁSTICO CABLE REDONDO / AGRAFE PLASTIQUE CÂBLE ROND / ROUND PLASTIC CABLE CLAMP  
FISSATORE IN PLASTICA, ROTONDO / GRAMPO PLÁSTICO CABO REDONDO



Ref			
5100 1094	6 mm	200	<b>0,03</b>
5100 1095	7 mm	200	<b>0,03</b>
5100 1096	8 mm	200	<b>0,04</b>
5100 1097	9 mm	200	<b>0,05</b>
5100 1098	10 mm	200	<b>0,05</b>
5100 1099	12 mm	200	<b>0,05</b>
5100 1100	14 mm	200	<b>0,06</b>

REGLETA CONEXIÓN / REGLETTE CONNEXION / CONNECTION BOARD  
MORSETTO CONNESSIONE / RÉGUA DE LIGAÇÃO



Ref		↔			
5100 1055		4 mm	1	10	<b>1,53</b>
5100 1056		6 mm	1	10	<b>1,80</b>
5100 1057		10 mm	1	10	<b>2,78</b>
5100 1058		16 mm	1	10	<b>3,65</b>
5100 1065		4 mm	1	10	<b>1,75</b>
5100 1066		6 mm	1	10	<b>1,80</b>
5100 1067		10 mm	1	10	<b>2,76</b>
5100 1068		16 mm	1	10	<b>3,65</b>





BASE MÚLTIPLE TOMAS 1,4M CABLE CON INT. (16A-250V) / BASE MULTIPRISE PRISES 1,4M CABLE AVEC INT. (16A-250V)  
WAY OUTLET POWER BOARD 1,4M CABLE (16A-250V) / CIABATTA MULTIPLA A PRESE 1,4M CAVO CON INT (16A-250V)  
RÉGUA DE ALIMENTAÇÃO TOMADAS 1,4M CABO COM INT. (16A-250V)

**Bricofan**

16A / 250V  
MAX: 3680W  
3G 1x5 mm<sup>2</sup>



Ref	VÍAS	↔	📦	📏	📄
5100 1002	2	1,5 m	1	10,38	✓
5100 1003	3	1,4 m	1	7,95	✓
5100 1004	4	1,4 m	1	8,99	✓
5100 1005	5	1,4 m	1	9,64	✓
5100 1006	6	1,4 m	1	10,44	✓

BASE BIPOLAR 3 TOMAS Y PROLONGACIÓN CON T/T LATERAL USB / BASE BIPOLAIRE 3 PRISES ET RALLONGE 1,5M AVEC T/T LATÉRALE  
BIPOLAR POWER STRIP 3 GANGS 1.5M CABLE WITH LATERAL EARTH CONNECTION / CIABATTA 3 SCHUKO BIPOLARI CON PROLUNGA 1,5M CON PRESE  
USB LATERALI / BASE BIPOLAR 3 TOMADAS E EXTENSÃO 1,5M C/ T/T LATERAL

**Bricofan**

16A / 250V  
MAX: 3680W  
2 USB



Ref	VÍAS	↔	A-V~	W MÁX	📦	📏	📄
5100 1234	3 + 2 USB	1,5 m	16A-250V	3680 W	1	26,55	✓

BASE MÚLTIPLE 6 TOMAS 1,5 M + 6 INT. INDIVIDUAL / MULTIPRISES 6 PRISES 1,5 M + 6 INT. INDIVIDUEL  
6-GANG POWER STRIP 1.5M + 5 INDIVIDUAL SWITCHES / MULTIPLA 6 PRESE 1,5M+6 INT. INDIVIDUALI  
BASE MÚLTIPLA 6 TOMADAS 1,5M + 6 INT.INDIVIDUAL

**Bricofan**

16A / 250V



Ref	VÍAS	↔	A-V~	W MÁX	📦	📏	📄
5100 1121	6	1,5 m	16A-250V	3680W	1	5	33,38



PROLONGADOR ELÉCTRICO (3 X 1,5 mm) / RALLONGE ELECTRIQUE (3 X 1,5 mm) / EXTENSION CABLE (3 X 1,5 mm)  
PROLUNGA ELETTRICA (3 X 1,5 mm) / EXTENSÃO ELÉTRICA (3 X 1,5 mm)



Ref	↔	📦	📊	📄
5100 1012	2 m	1	7,38	✓
5100 1013	3 m	1	10,85	✓
5100 1015	5 m	1	13,95	✓

PROLONGADOR BIPOLAR ESPIGA Ø4 CABLE BLANCO / RALLONGE BIPOLAIRE ÉPIØ4 CABLE BLANC / 2-PIN EXTENSION LEAD Ø4 PIN WHITE CABLE  
PROLUNGA BIPOLARE Ø4 CAVO BIANCA / PROLONGADOR BIPOLAR UMA FICHA Ø4 CABO BRANCO

**Bricofan**

10A / 250V  
MAX: 2300W  
2 x 1 mm<sup>2</sup>



Ref	↔	A-V~	W MÁX	📦	📊	📄
5100 1010	3 m	10A-250V	2300 W	1	6,16	✓
5100 1011	5 m	10A-250V	2300 W	1	8,60	✓

PROLONGADOR BIPOLAR CON T/T LATERAL CABLE NARANJA / RALLONGE BIPOLAIRE AVEC T/T LATERALE CABLE 10M ORANGE  
2-PIN EXTENSION LEAD WITH LATERAL EARTH CONNECTION ORANGE CABLE / PROLUNGA SCHUKO BIPOLARE ARANCIONE  
PROLONGADOR BIPOLAR COM T/T LATERAL LARANJA

**Bricofan**

16A / 250V  
MAX: 3680W  
3G 1x5 mm<sup>2</sup>  
IP-44



Ref	📦	↔	A-V~	W MÁX	📦	📊	📄
5100 1008	🟠	10 m	16A-250V	3680 W	1	32,62	✓
5100 1009	🟠	25 m	16A-250V	3680 W	1	67,05	✓



ENROLLACABLES 4 TOMAS (3 X 1,5 mm) / ENROULEUR CABLE 4 PRISES (3 X 1,5 mm) / 4 WAY EXTENSION CABLE REEL, (3 X 1,5 mm)  
AVVOLGICAVO ELETTRICO A 4 PRESE (3 X 1,5 mm) / ENROLADOR DE CABO 4 TOMADAS (3 X 1,5 mm)



Ref	↔	📦	📊
5100 1107	7 m	1	26,94
5100 1108	20 m	1	56,45

ALARGADOR CABLE 4 TOMAS (3 X 1,5 mm) / ENROULEUR CABLE 4 PRISES (3 X 1,5 mm) / 4 WAY EXTENSION CABLE REEL, (3 X 1,5 mm)  
AVVOLGICAVO ELETTRICO A 4 PRESE (3 X 1,5 mm) / EXTENSÃO ELÉTRICA COM ENROLADOR 4 TOMADAS (3X1,5 mm)



Ref	↔	📦	📊
5100 1109	25 m	1	67,27
5100 1110	50 m	1	127,00

ENROLLACABLES AUTOMÁTICO CON SOPORTE PARED 1 TOMA / BASE MULIPRISE 6T, CABLE AVEC INT.  
6 WAY OUTLET GERMAN POWER BOARD CABLE / CIABATTA MULTIPLA A 6 PRESE CAVO C/INT. / RÉGUA DE ALIMENTAÇÃO 6T, CABLE C/INT.



3G 1x5 mm<sup>2</sup>  
H05VVF

Ref	↔	📦	📊
5100 1106	11 m (9+2)	1	90,28



CONECTOR ANTENA RECTO / CONNECTEUR ANTENNE DROIT / ANTENNA CONNECTOR STRAIGHT  
CONNETTORE DRITTO PER ANTENNA / CONECTOR DE ANTENA MACHO RETO



Ref	VÍAS	↔	📦	📦	📦
5100 1045	M	9,5 mm	1	10	0,75
5100 1046	H	9,5 mm	1	10	0,83

CONECTOR ANTENA CODO / CONNECTEUR ANTENNE COUDE / ANTENNA CONNECTOR ELBOW TYPE  
CONNETTORE RACCORDO ANTENNA / CONECTOR DE ANTENA MACHO COTOVELO

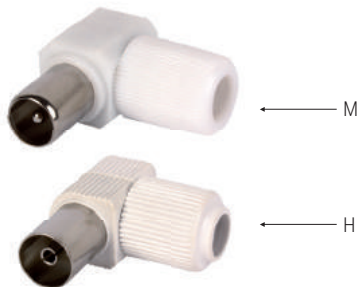

Ref	VÍAS	↔	📦	📦	📦
5100 1047	M	9,5 mm	1	10	0,68
5100 1048	H	9,5 mm	1	10	0,68

ADAPTADOR ANTENA "T" / ADAPTATEUR ANTENNE "T" / ANTENNA ADAPTER "T" / ADATTATORE A "T" PER ANTENNA / ADAPTADOR DE ANTENA "T"

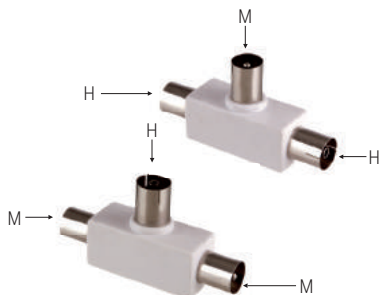

Ref	VÍAS	📦	📦	📦
5100 1049	1H - 2M	1	10	1,66
5100 1050	1M - 2H	1	10	1,66

PROLONGACIÓN ANTENA + CONECTORES / RALLONGE ANTENNE + CONNECTEURS / ANTENNA EXTENSION CABLE + CONNECTORS  
PROLUNGA ANTENNA + CONNETTORI / EXTENSÃO DE ANTENA + CONECTORES



Ref	↔	📦	📦	📦
5100 1041	1,5 mm	1	10	2,14
5100 1042	2,5 mm	1	10	3,75

BASE ANTENA / BASE ANTENNE / ANTENNA SOCKET / ANTENNA / ANTENA



Ref	📦	VÍAS	📦	📦	📦
5100 1051	1 TOMA (HEMBRA) / 1 PRISE (FEMELLE) / 1 WAY (FEMALE) 1 PRESA (FEMMINA) / 1 TOMADA (FÊMEA)	H	1	10	9,20
5100 1053	SUPERFICIE / SUPERFICIE / ANTENNA SOCKET BASE ANTENNA / SUPERFÍCIE	M - H	1	10	6,76
5100 1054	SUPERFICIE 2 TOMAS + SATÉLITE / SUPERFICIE 2 PRISES + SATELLITE 2 WAYS + SATELLITE / 2 PRESE + SATELLITE SUPERFÍCIE 2 TOMADAS + SATÉLITE		1	10	12,69



CABLE ANTENA / CÂBLE ANTENNE SATELLITE BLANC / WHITE ANTENNA CABLE  
CAVO ANTENNA SATELLITE VATC BIANCO / CABO ANTENNA BRANCO

5 -10 -100 m



Ref				
5100 2130	COAXIAL - 75 Ohm	100 m	1	91,68

100 m



Ref				
5100 2131	SATÉLITE-TDT - COBRE	100 m	1	126,30

CABLE PLANO TELÉFONO CON TOMAS / CÂBLE PLAT TÉLÉPHONE AVEC PRISES / TELEPHONE FLAT CABLE  
CAVO PIATTO TELEFONO CON PRESE / CABO PLANO PARA TELEFONE COM TOMADAS



Ref				
5100 1062	2,2 m	1	10	2,57
5100 1064	4,5 m	1	10	4,09



TEMPERATURA DE LA LUZ "KELVIN" / TEMPÉRATURE DE LA LUMIÈRE "KELVIN" / "KELVIN" LIGHT TEMPERATURE  
 TEMPERATURA DELLA LUCE "KELVIN" / TEMPERATURA DA LUZ "KELVIN"



6000 K - Luz fría



3000 K - Luz Cálida

ES La temperatura del color corresponde al tono de luz de una fuente lumínica.

Cuanto más elevada es la temperatura del color (6000 ó 6500K), más "fría" y azul se verá la fuente de luz blanca, ideal para zonas de alta actividad y concentración de personas.

Cuanto más baja sea la temperatura (2700 ó 3000K), más "cálida" y acogedora será su apariencia, ideal para zonas de relax o descanso.

Los tonos de luz en iluminación son:

- "Luz cálida" confortable (2700-3000 Kelvin). Equivale a la luz de las bombillas incandescentes.
- "Luz intermedia" (4000 Kelvin). Puede ser la luz más natural.
- "Luz natural fría" (6000-6500 Kelvin). Equivaldría a la luz de un día soleado.

FR La température de la couleur correspond au ton de lumière d'une source lumineuse.

Plus la température de la couleur est élevée (6000 ou 6500K), plus la source de lumière blanche sera froide et bleue, idéal pour des lieux de haute activité et forte concentration de personnes.

Plus la température sera basse (2700 ou 3000K), plus la source de lumière sera chaude et accueillante, idéal pour des lieux de repos.

Les tons de lumière sont :

- Confort chaud (2700-3000 kelvin). équivalent à la lumière naturelle des ampoules incandescentes.
- Lumière intermédiaire (4000 kelvin). lumière la plus naturelle.
- Lumière naturelle froide (6000-6500 kelvin). équivalent à la lumière jour ensoleillé.

EN The color temperature corresponds to the light tone of a light source.

The most elevated the color temperature gets (6000 or 6500k), the "coldest" and blueish the white source will be. suitable for high activity areas and people gatherings.

The lowest the color temperature gets (2700 or 3000k), the "warmest" and cosy its appearance will be. suitable for relaxation areas.

The illumination's tones are:

- Comfortable "warm light" (2700-3000 kelvin). it corresponds to the incandescent light bulbs' natural light.
- "Middle light" (4000 kelvin). it may be the more natural light.
- "Cold natural light" (6000-6500 kelvin). it corresponds to a sunny light day.

IT La temperatura del colore corrisponde al tono della luce di una sorgente luminosa.

Quanto più elevata è la temperatura del colore (6000 o 6500k), più "fredda" e blu si vedrà la fonte di luce bianca, ideale per zone ad alta attività e concentrazione di persone.

Quanto più bassa è la temperatura (2700 o 3000k), più "calda" e accogliente si vedrà, ideale per zone di relax e riposo.

I toni della luce luminosa sono:

- "Luce calda" confortevole (2700-3000 kelvin). equivalente alla luce naturale di lampade a incandescenza.
- "Luce intermedia" (4000 kelvin). può essere luce più naturale.
- "Luce naturale fredda" (6000-6500 kelvin). equivalente alla luce di un giorno soleggiato.

PT A temperatura da cor corresponde ao tom da luz de uma fonte lumínica.

Quanto mais elevada é a temperatura da cor (6000 ó 6500k), mais "fría" e azul se verá a fonte de luz branca, ideal para zonas de alta actividade e concentraçao de pessoas.

Quanto mais baixa seja a temperatura (2700 ó 3000k), mais "cálida" e acolhedora será a sua aparência e será ideal para zonas de relax ou descanso.

Os tons de luz em iluminação são:

- Luz cálida confortável (2700-3000 kelvin). equivale há luz natural das lampadas incandescentes.
- Luz intermedia (4000 kelvin). pode ser a luz mais natural.
- Luz natural fría (6000-6500 kelvin). equivaleria há luz de um dia soleado.



## REGLETA LED BLANCA / REGLETTE LED BLANC / LED STRIP WHITE / STRISCIA LED BIANCA / RÉGUA LED BRANCO

**Bricofan**25.000h  
-85% ENERGY**CON INTERRUPTOR / WITH SWITCH**

ES - Regleta con interruptor.

- Ángulo del haz: 120°.

- Las regletas LED de Cofan son unas bandas luminosas de diferentes tamaños, perfectas para instalar donde la luz del techo no llega. Cada vez se instalan más en cocinas o armarios y, gracias a su interruptor, puedes controlar cuándo es necesaria.

- La instalación es rápida y sencilla, pudiéndose colocar de forma individual o agrupada.

FR - Réglette avec interrupteur.

- Angle du haz: 120°.

- Les réglettes LED Cofan sont des bandes lumineuses de différentes tailles, idéales pour être installées dans les parties que la lumière de plafond n'atteint pas. De nombreuses installations dans les cuisines et les armoires qui peuvent être contrôlées grâce à l'interrupteur quand nécessaire.

- L'installation est rapide et simple, elles peuvent être installées individuellement ou groupées.

EN - LED strip with switch.

- Angle beam: 120°

- Cofan LED strips are luminous bands available in different sizes and perfect to place them in those areas where the ceiling light does not reach. They are increasingly being used in kitchens or cupboards and, thanks to its switch, you can control when the light is necessary.

- Easy and quick to install. It is possible to place them individually or in groups.

IT - Striscia LED con interruttore.

- Angolo apertura: 120°.

- Le strisce LED Cofan sono bande luminose di dimensioni differenti, perfette da installare nelle zone non raggiunte dalla luce del soffitto. Normalmente installate in cucina o armadi, grazie al pratico interruttore è possibile utilizzarle unicamente se necessario.

- Installazione facile e veloce, facilmente collocabili singolarmente o raggruppate.

PT - Régua de alimentação com interruptor.

- Ângulo do feixe: 120°.

- As régua LED da Cofan são tiras luminosas de diferentes tamanhos, perfeitas para as instalar onde não chega a luz do teto. Cada vez mais se instalam em cozinhas ou armários e, graças ao seu interruptor, pode controlar quando for necessário.

- A instalação é rápida e fácil, podendo ser colocada individualmente ou agrupada.

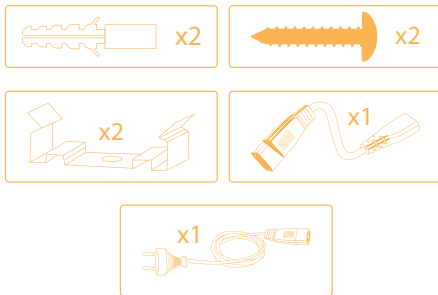

Ref	W	Lm	↔	<	📦	📦	📦	📦
5200 7060	5W	320 lm	301 mm	120°	1	6	12,39	✓
5200 7061	8W	640 lm	546 mm	120°	1	6	16,38	✓

## TUBO LED G13 / TUBE LED G13 / LED TUBE G13 / TUBO LED G13 / TUBO LED G13

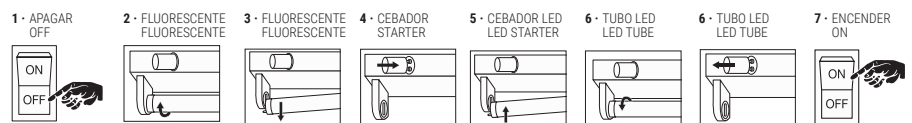
**Bricofan**30.000h  
-85% ENERGY**INCLUYE CEBADOR / STARTED INCLUDED**

ES Los tubos LED son la mejor solución para sustituir a los fluorescentes convencionales ya que reducen el consumo energético. Proporcionan una luz muy agradable ya que no parpadean y el arranque es inmediato. Es posible hacer una sustitución directa con el fluorescente tradicional sin realizar ningún cableado, siempre y cuando los fluorescentes trabajen con un balastro electromagnético.

fr Les tubes LED sont la meilleure solution pour remplacer les néons conventionnels car ils réduisent la consommation énergétique et fournissent une lumière très agréable puisqu'ils ne clignotent pas et le démarrage est immédiat. Il est possible de faire un remplacement direct avec le néon traditionnel sans effectuer de nouveau câblage, si les néons fonctionnent avec un ballast électromagnétique.

EN LED tubes are the best solution to replace the conventional fluorescent lamps since they reduce power consumption. They provide very pleasant light, do not blink and have an immediate start. It is possible to replace directly the traditional tube without installing any wiring and only when fluorescent lamps work with electromagnetic ballast.

IT I tubi LED sono la soluzione migliore per sostituire le illuminazioni convenzionali grazie alla riduzione dei consumi energetici. Forniscono inoltre una luce molto piacevole in quanto non generano sfarfallio e l'accensione è immediata. È possibile effettuare una sostituzione diretta con luci tradizionali senza realizzare nessun cablaggio fintanto che si lavora con un ballast elettromagnetico.

PT Os tubos LED são a melhor solução para substituir aos fluorescentes convencionais porque reduzem o consumo de energia. Fornecem uma luz muito agradável, não piscam e o arranque é imediato. É possível fazer uma substituição direta com o fluorescente tradicional sem necessitar nenhum cabo, desde que os fluorescentes trabalhem com um balastro eletromagnético.



Ref	W	Lm	↔	<	📦	📦	📦	📦
5200 7070	9W	80 lm	600 mm	200°	1	10	11,76	✓
5200 7071	18W	1620 lm	1200 mm	200°	1	10	16,38	✓



BOMBILLA LED CLASIC / AMPULE LED CLASSIC / LED BULB CLASSIC / LAMPADINA LED CLASSICA / LÂMPADA LED CLASIC



E27

15.000h

-85% ENERGY



3000 K



6500 K



Bricofan



Ref	W	Lm	☐	◁	☐	☐	☐	☐
5200 7001	6W	470 lm	E27	240°	1	10	4,40	✓
5200 7003	9W	810 lm	E27	240°	1	10	4,72	✓

Ref	W	Lm	☐	◁	☐	☐	☐	☐
5200 7002	6W	470 lm	E27	240°	1	10	4,40	✓
5200 7004	9W	810 lm	E27	240°	1	10	4,72	✓
5200 7005	12W	1050 lm	E27	240°	1	10	5,44	✓

BOMBILLA LED ESFÉRICA / AMPULE LED SPHÉRIQUE / LED BULB SPHERICAL / LAMPADINA LED SFERICA / LÂMPADA LED ESFÉRICA



E27

15.000h

-85% ENERGY



3000 K



6500 K



Bricofan



Ref	W	Lm	☐	◁	☐	☐	☐	☐
5200 7010	5W	400 lm	E27	220°	1	10	3,92	✓

Ref	W	Lm	☐	◁	☐	☐	☐	☐
5200 7013	5W	400 lm	E27	220°	1	10	3,92	✓



E14

15.000h

-85% ENERGY



3000 K



6500 K



Bricofan



Ref	W	Lm	☐	◁	☐	☐	☐	☐
5200 7012	5W	400 lm	E14	220°	1	10	3,92	✓

Ref	W	Lm	☐	◁	☐	☐	☐	☐
5200 7011	5W	400 lm	E14	220°	1	10	3,92	✓



## LÁMPARA LED / LAMPE LED / LED LAMP / LAMPADINA LED / LÂMPADA LED

2 YEARS WARRANTY RC-80 A+

BOMBILLA LED VELA / AMPULE LED VEILLE / LED BULB CANDLE / LAMPADINA LED CANDELA / LÂMPADA LED VELA



E14

15.000h  
-85% ENERGY



**Bricofan**



3000 K

Ref	W	Lm	Icon	Angle	Grid	Box	Stack	Price	Check
5200 7014	5W	400 lm	E14	220°	1	10	3,92	✓	



6500 K

Ref	W	Lm	Icon	Angle	Grid	Box	Stack	Price	Check
5200 7015	5W	400 lm	E14	220°	1	10	3,92	✓	

LÁMPARA LED COB GU-5,3 / LAMPE LED COB GU-5,3 / LED LAMP COB GU-5,3 / LAMPADINA LED COB GU-5,3 / LÂMPADA LED COB GU-5,3



GU5.3

12V  
15.000h  
-85% ENERGY



**Bricofan**



3000 K

Ref	W	Icon	Lm	Angle	Grid	Box	Stack	Price	Check
5200 7021	5W	3000 K	400 lm	110°	1	10	5,72	✓	

LÁMPARA LED GU-10 / LAMPE LED GU-10 / LED LAMP GU-10 / LAMPADINA LED GU-10 / LÂMPADA LED GU-10



GU10

15.000h  
-85% ENERGY



**Bricofan**



3000 K

Ref	W	Icon	Lm	Angle	Grid	Box	Stack	Price	Check
5200 7022	5W	3000 K	400 lm	110°	1	10	4,76	✓	
5200 7025	7W	3000 K	500 lm	110°	1	10	5,90	✓	



5000 K

Ref	W	Icon	Lm	Angle	Grid	Box	Stack	Price	Check
5200 7023	5W	5000 K	400 lm	110°	1	10	4,76	✓	
5200 7024	5W	5000 K	395 lm	60°	1	10	5,90	✓	
5200 7026	7W	5000 K	500 lm	110°	1	10	5,90	✓	

BOMBILLA GLOBO / AMPOULE GLOBE / GLOBE BULB / LAMPADINA GLOBO / LÂMPADA GLOBO



E27

25.000h  
-85% ENERGY



**Bricofan**



4000 K

Ref	W	Icon	Lm	Icon	Angle	Grid	Box	Stack	Price	Check
5200 7050	11W	4000 K	820 lm	E27	250°	1	10	15,16	✓	
5200 7051	18W	4000 K	1520 lm	E27	270°	1	10	21,04	✓	



BOMBILLA CLASIC SENSOR / AMPULE CLASSIC DÉTECTEUR / LED CLASSIC DETECTOR / LAMPADINA CLASSICA RILEVATORE / LÂMPADA CLASIC DETECTOR

E27

SENSOR DE PRESENCIA / PROXIMITY SENSOR



25.000h **Bricofan**

-85% ENERGY

ES La bombilla con detector de presencia es perfecta para lugares de paso como trasteros, pasillos, garajes, etc. Características del sensor:

- Ángulo de detección: 360°
- Distancia de detección: <6 metros

Si detecta movimiento menos de 3 minutos, tardaría en apagarse 10 segundos. Si detectara movimiento más de 3 minutos, tardaría en apagarse 120 segundos.

FR L'ampoule avec détecteur de présence est parfaite pour les débarras, couloirs, garages, etc. Caractéristiques du capteur:

- Angle de détection: 360°
- Distance de détection: < 6 mètres

Si un mouvement est détecté en moins de 3 minutes, elle s'éteindra en 10 secondes. Si un mouvement est détecté à plus de 3 minutes, elle s'éteindra en 120 secondes.

EN The bulb with proximity sensor is perfect for places such as box rooms, corridors, garages, etc. Features:

- Detection angle: 360°
- Distance detected: <6 meters

If motion detected lasts less than 3 minutes, it turns off 10 seconds later. If motion detected lasts more than 3 minutes, it turns off 120 seconds later.

IT La lampadina con rilevatore di presenza è perfetta per luoghi di passaggio come: ripostiglio, corridoio, garage, ecc. Le caratteristiche del sensore sono:

- Angolo di rilevamento: 360°
- Distanza di rilevamento: <6 metri

Se viene rilevato un movimento inferiore a 3 minuti, il tempo di spegnimento è di 10 secondi. Se viene rilevato un movimento superiore ai 3 minuti, occorreranno invece 120 secondi per lo spegnimento.

PT A lâmpada com detector de presença é perfeita para locais de passagem, como quartos de arrumo, corredores, garagens, etc. Características do sensor:

- Ângulo de detecção: 360°
- Distância de detecção: <6 metros

Se detectar movimentos menos de 3 minutos, demoraria 10 segundos para desligar. Se detectou movimento mais de 3 minutos, demoraria 120 segundos para desligar.



Ref	W	Lm	<	E27	1	6	24,04	✓
5200 7031	10W	806 lm	240°	E27	1	6	24,04	✓

E27

SENSOR CREPUSCULAR / TWILIGHT SENSOR



25.000h **Bricofan**

-85% ENERGY



ES Bombilla con sensor crepuscular perfecta para iluminar automáticamente las estancias que deseamos de la casa cuando se hace de noche. Se enciende automáticamente cuando detecta una luz ambiente de <20 lux. Además, el doble sensor incorporado le da mayor precisión.

fr Ampoule avec capteur crépusculaire, idéale pour éclairer automatiquement les pièces souhaitées de la maison dès que la nuit tombe. Elle s'allume automatiquement quand une lumière ambiante < à 20 lux est détectée. Le double capteur intégré lui permet une plus grande précision.

EN The bulb with twilight sensor is perfect for lighting automatically any room of the house when it gets darker. It turns on automatically when it detects an ambient light <20 lux. In addition, the built-in double sensor provides greater accuracy.

IT La lampadina con sensore crepuscolare è perfetta per illuminare automaticamente le camere desiderate quando è notte. Si accende automaticamente quando viene rilevata una luce ambientale <20 lux. Inoltre, il doppio sensore offre una maggiore precisione.

PT A lâmpada com sensor de crepúsculo é perfeita para iluminar automaticamente os quartos da casa que desejamos, quando está escuro. Liga-se automaticamente quando detecta luz ambiente <20 lux. Além disso, o sensor duplo incorporado fornece mais precisão.



Ref	W	Lm	<	E27	1	6	19,36	✓
5200 7032	9,5W	806 lm	240°	E27	1	6	19,36	✓





BOMBILLA LED CLASIC FILAMENTO / AMPOULE LED FILAMENT CLASSIQUE / CLASSIC LED BULB WITH FILAMENT  
LAMPADINA LED CLASSICA FILAMENTO / LÂMPADA LED CLASSIC FILAMENTO



**E27 7W**  
**806 Lm**  
**2700K**  
**15000 h**  
**-90% Ahorro Energía / Energy-efficient**  
**360°**



Ref	W		Lm					
5200 4002	7W	2700 K	806 lm	E27	1	10	7,64	✓

BOMBILLA LED ESFÉRICA FILAMENTO / AMPOULE LED FILAMENT SPHÉRIQUE / SPHERICAL LED BULB WITH FILAMENT  
LAMPADINA SFERICA A LED FILAMENTO / LÂMPADA LED ESFÉRICA FILAMENTO



**E14 4W**  
**470 Lm**  
**2700 K**  
**15000 h**  
**-90% Ahorro Energía / Energy-efficient**  
**360°**



Ref	W		Lm					
5200 4006	4W	2700 K	470 lm	E14	1	10	6,58	✓

BOMBILLA LED ESFÉRICA FILAMENTO / AMPOULE LED FILAMENT SPHÉRIQUE / SPHERICAL LED BULB WITH FILAMENT  
LAMPADINA SFERICA A LED FILAMENTO / LÂMPADA LED ESFÉRICA FILAMENTO



**E27 4W**  
**470 Lm**  
**2700K**  
**1500 h**  
**- 90% Ahorro Energía / Energy-efficient**  
**360°**



Ref	W		Lm					
5200 4007	4W	2700 K	470 lm	E27	1	10	6,58	✓

BOMBILLA LED VELA FILAMENTO / AMPOULE LED FILAMENT VELA / CANDLE LED BULB WITH FILAMENT  
LAMPADINA A LED CANDELA / LÂMPADA LED VELA FILAMENTO



**E14 4W**  
**470 Lm**  
**2700K**  
**13000 h**  
**- 90% Ahorro Energía / Energy-efficient**  
**360°**



Ref	W		Lm					
5200 4009	4W	2700 K	470 lm	E14	1	10	6,58	✓



BOMBILLA LED GLOBO CLARO / AMPOULE LED FILAMENT GLOBE CLAIR / GLOBE LED BULB (LIGHT)  
LAMPADINA LED GLOBO CHIARO / LÂMPADA LED GLOBO CLARO



**E27 4W**  
**380 Lm**  
**2700K**



Ref	W	☺	Lm	⚡	📏	📦	📦	📦	📦
5200 4021	4W	2700 K	380 lm	E27	1	10	24,56	✓	

BOMBILLA LED GLOBO ORO / AMPOULE LED FILAMENT GLOBE OR / GLOBE LED BULB (GOLD)  
LAMPADINA LED GLOBO ORO / LÂMPADA LED GLOBO OURO



**E27 4W**  
**280 Lm**  
**2200K**



Ref	W	☺	Lm	⚡	📏	📦	📦	📦	📦
5200 4022	4W	2200 K	280 lm	E27	1	10	21,68	✓	

BOMBILLA LED GLOBO ESTRELLAS / AMPOULE LED FILAMENT EN ETOILE GLOBE / GLOBE LED BULB (STARS)  
LAMPADINA LED GLOBO STELLA / LÂMPADA LED GLOBO ESTRELAS



**E27 1,2W**  
**50 Lm**  
**2700K**



Ref	W	☺	Lm	⚡	📏	📦	📦	📦	📦
5200 4023	1,2W	2700 K	50 lm	E27	1	10	25,16	✓	

BOMBILLA LED GLOBO ESPIRAL / AMPOULE LED FILAMENT EN SPIRALE GLOBE / GLOBE LED BULB (SPIRAL)  
LAMPADINA LED GLOBO SPIRALE / LÂMPADA LED GLOBO ESPIRAL



**E27 4W**  
**170 Lm**  
**2200K**



Ref	W	☺	Lm	⚡	📏	📦	📦	📦	📦
5200 4024	4W	2200 K	170 lm	E27	1	10	25,16	✓	



CABLE PARA LÁMPARA DECO ORO CLARO / CABLE POUR GLOBE DECO OR CLAIR / LAMPHOLDER CABLE FOR PENDANT GLOBE BULB (LIGHT GOLD)  
LAMPADINA LED GLOBO DÉCO ORO CLARO / CABO PARA GLOBO DECO OURO CLARO



E27  
100 x 10 cm

Bricofan

Ref					
5200 4041	E27	100 x 10 cm	1	28,85	✓

CABLE PARA LÁMPARA DECO ORO / CABLE POUR GLOBE DECO OR / LAMPHOLDER CABLE FOR PENDANT GLOBE BULB (GOLD)  
LAMPADINA LED GLOBO DÉCO ORO / CABO PARA GLOBO DECO OURO



E27  
100 x 10 cm

Bricofan

Ref					
5200 4042	E27	100 x 10 cm	1	28,85	✓

CABLE PARA LÁMPARA DECO PERLA / CABLE POUR GLOBE DECO PERLE / LAMPHOLDER CABLE FOR PENDANT GLOBE BULB (PEARL)  
LAMPADINA LED GLOBO DÉCO PERLA / CABO PARA GLOBO DECO PERLA



E27  
100 x 10 cm

Bricofan

Ref					
5200 4043	E27	100 x 10 cm	1	28,85	✓

CABLE PARA LÁMPARA DECO ORO NÍQUEL / CABLE POUR GLOBE DECO NICKEL / LAMPHOLDER CABLE FOR PENDANT GLOBE BULB (NIQUEL)  
LAMPADINA LED GLOBO DÉCO NICHÉL / CABO PARA GLOBO DECO NÍQUEL



E27  
100 x 10 cm

Bricofan

Ref					
5200 4044	E27	100 x 10 cm	1	28,85	✓

CABLE PARA LÁMPARA DECO ORO ROSA / CABLE POUR GLOBE DECO OR ROSE / LAMPHOLDER CABLE FOR PENDANT GLOBE BULB (ROSE GOLD)  
LAMPADINA LED GLOBO DÉCO ORO ROSA / CABO PARA GLOBO DECO OURO ROSA



E27  
100 x 10 cm

Bricofan

Ref					
5200 4045	E27	100 x 10 cm	1	28,85	✓



EXPOSITOR ELÉCTRICO MOSTRADOR 2 LÁMPARAS E27 / PRESENTOIR ELECTRIQUE COMPTOIR 2 AMPOULES E27  
 ELECTRIC DISPLAY FOR 2 GLOBE BULBS E27 / ESPOSITORE ELETTRICO PER LAMPADINE, CON ATTACCO E27  
 EXPOSITOR ELÉTRICO AMOSTRA 2 LÂMPADAS E27

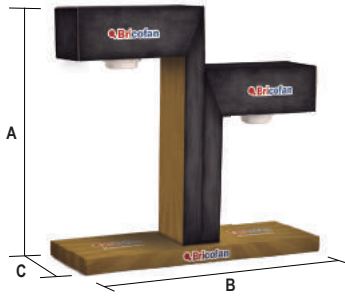

Ref	A	B	C		
0450 0005	370 mm	390 mm	130 mm	1	70,98

PROYECTOR LED SMD 4000K / PROJECTEUR LED SMD / SMD LED PROJECTOR / PROIETTORE LED SMD / PROJECTOR LED SMD



**Negro IP65**

**25.000h**

-190% ENERGY

Ref	W		Lm	<			
5200 5030	10W	4000K	1070 lm	140°	128 x 120 x 45	1	19,83
5200 5031	20W	4000K	2140 lm	140°	180 x 185 x 45	1	31,04
5200 5032	30W	4000K	4200 lm	160°	170 x 190 x 48	1	55,70
5200 5033	50W	4000K	7000 lm	160°	170 x 190 x 48	1	63,90



PROYECTOR LED SMD BLANCO 4000K / PROJECTEUR LED SMD BLAN 4000K / 4000K WHITE LED PROJECTOR SMD  
 WHITE LED PROJECTOR SMD 4000K / PROJETOR LED SMD BRANCO 4000K



**IP65 25.000h**

-90% ENERGY

Ref	W		Lm	<			
5200 5036	10W	4000K	1070 lm	140°	128 x 120 x 45	1	19,83
5200 5037	20W	4000K	2140 lm	140°	180 x 185 x 45	1	32,62
5200 5038	30W	4000K	4200 lm	160°	170 x 190 x 48	1	55,70
5200 5039	50W	4000K	7000 lm	160°	170 x 190 x 48	1	63,90



PROYECTOR LED SMD 4000K CON SOPORTE / PROJECTEUR LED SMD 4000K / LED PROJECTOR SMD 4000K WITH SUPPORT  
 PROIETTORE A LED SMD 4000K / PROJETOR LED SMD 4000K COM SUPORTE



**Negro IP65**

**25.000h**

-90% ENERGY

Con soporte / Avec support / With support / Con supporto / Com suporte

Ref	W		Lm	<			
5200 5040	10W	4000K	1070 lm	140°	270x195x165	1	29,42



FOCO LED PORTÁTIL A BATERÍA / PROJECTEUR LED PORTABLE A BATTERIE / PORTABLE LED WORK LIGHT BATTERY-OPERATED  
 FARETTO LED PORTATILE A BATTERIA / FOCO LED PORTÁTIL A BATERIA



**Li-ion**

**18V 20W**

**BATERÍA / BATTERY**

**FULL LIGHT: 60%**

**LIGHT: 30%**

**LIGHT OFF**

Ref	LED W		BATTERY		Lm		
5000 3206	20W	18V - 1500mAh	Litio Li-ion	6000 °k	1800 Lm	1 h	141,44



DOWNLIGHTS EMPOTRAR / DOWNLIGHTS A ENCASTRER / EMBEDDED DOWNLIGHT / FARETTI INCASSO / DOWNLIGHTS EMBUTIR



LED



25.000h IP 20

-90% ENERGY

6000K



Ref	⊕	W	Lm	∅	∅ CORTE	📦	📦
5200 6109	6000K	3W	336 lm	90 mm	72 mm	1	12,16
5200 6107	6000K	6W	672 lm	120 mm	106 mm	1	13,81
5200 6105	6000K	9W	1008 lm	150 mm	134 mm	1	22,39
5200 6103	6000K	12W	1344 lm	170 mm	154 mm	1	18,08
5200 6101	6000K	20W	2240 lm	225 mm	205 mm	1	21,11
5200 6099	6000K	30W	3360 lm	300 mm	280 mm	1	37,95

DOWNLIGHTS SUPERFICIE / DOWNLIGHTS SURFACE / SURFACE DOWNLIGHT / FARETTI SUPERFICIE / DOWNLIGHTS SUPERFÍCIE



LED



25.000h IP 20

-90% ENERGY

6000K



Ref	⊕	W	Lm	∅	📦	📦
5200 6114	6000K	6W	810	120 x 40 mm	1	21,11
5200 6113	6000K	12W	1620	180 x 40 mm	1	18,40
5200 6111	6000K	20W	2700	240 x 40 mm	1	19,85
5200 6110	6000K	30W	4050	300 x 40 mm	1	39,95

DOWNLIGHTS REDONDO EMPOTRAR 20W / DOWNLIGHTS EMBED 20W / 20W ENCASTRER DOWNLIGHTS  
DOWNLIGHT AD INCASSO 20W / DOWNLIGHTS EMBUTIR 20W



LED

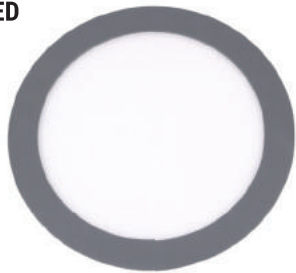

25.000h IP 20

-90% ENERGY

6000K

Aluminio / Aluminium / Aluminium / Alluminio / Alumínio



Ref	⊕	W	Lm	∅	∅ CORTE	📦	📦
5200 6102	6000K	20W	2240 lm	225 mm	205 mm	1	51,94

DOWNLIGHTS REDONDO SUPERFICIE BLANCO 20W / DOWNLIGHTS SURFACE BLANC 20W / 20W WHITE SURFACE DOWNLIGHTS  
DOWNLIGHT AD INCASSO BIANCO 20W / DOWNLIGHTS SUPERFÍCIE BRANCO 20W



LED

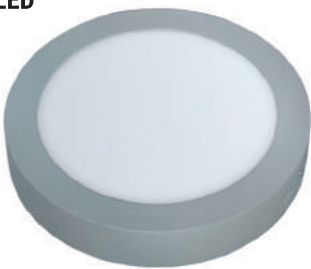

25.000h IP 20

-90% ENERGY

6000K



Ref	⊕	W	Lm	∅	📦	📦
5200 6112	6000K	20W	2700 lm	240 X 40 mm	1	34,54

TIRA LED 3 METROS / BANDE LED 3M / LED STRIP 3M / STRISCIA LED 3M / FAIXA LED 3M



LED



6500 K

ON OFF  
25.000

50.000h

-85% ENERGY

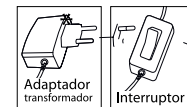
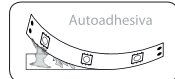
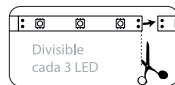

\*Máx. 3 metros por transformador.



Ref	W	Lm	↔	📦	📦	📦	📦
5200 7076	22W	1350 lm	3 m	1	6	66,78	✓





APLIQUE LED SOLAR CON SENSOR GRIS / APPLIQUER LED SOLAIRE AVEC CAPTEUR GRIS / LED SOLAR WALL LAMP WITH GREY SENSOR  
LAMPADA DA PARETE LED SOLARE CON SENSORE GRIGIO / APLIQUE LED SOLAR COM SENSOR CINZENTO

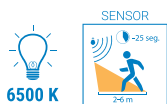
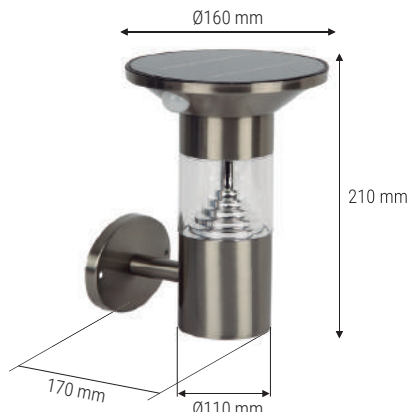

**STAINLESS STEEL + PC**

**IP44**  
**LED-SMD**  
**300 h**  
**Recarga luz solar.**

Ref	W	∠	⚡	BATTERY	Lm	📦	🔋
5000 3161	3 W	90°	3,7V - 2200 mAh	Litio Li-ion	500 lm	1	82,26

BALIZA LED SOLAR CON SENSOR GRIS / BALISE LED SOLAIRE AVEC CAPTEUR GRIS / LED SOLAR BOLLARD WITH GREY SENSOR  
LAMPIONCINO LED SOLARE CON SENSORE GRIGIO / BALIZA LED SOLAR COM SENSOR CINZENTO

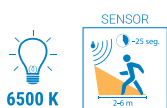

**STAINLESS STEEL + PC**

**IP44**  
**LED-SMD**  
**300 h**  
**Recarga luz solar.**

Ref	W	∠	⚡	BATTERY	Lm	📦	🔋
5000 3162	3 W	90°	3,7V - 2200 mAh	Litio Li-ion	500 lm	1	88,45

APLIQUE LED SOLAR CON SENSOR NEGRO / APPLIQUER LED SOLAIRE AVEC CAPTEUR NOIR / LED SOLAR WALL LAMP WITH BLACK SENSOR  
LAMPADA DA PARETE LED SOLARE CON SENSORE NERO / APLIQUE LED SOLAR COM SENSOR NEGRO

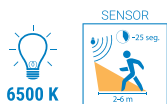

**STAINLESS STEEL + PC**

**IP44**  
**LED-SMD**  
**300 h**  
**Recarga luz solar.**

Ref	W	∠	⚡	BATTERY	Lm	📦	🔋
5000 3171	3 W	90°	3,7V - 2200 mAh	Litio Li-ion	500 lm	1	82,26

BALIZA LED SOLAR CON SENSOR GRIS / BALISE LED SOLAIRE AVEC CAPTEUR GRIS / LED SOLAR BOLLARD WITH GREY SENSOR  
LAMPIONCINO LED SOLARE CON SENSORE GRIGIO / BALIZA LED SOLAR COM SENSOR CINZENTO

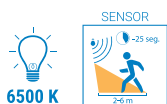

**STAINLESS STEEL + PC**

**IP44**  
**LED-SMD**  
**300 h**  
**Recarga luz solar.**

Ref	W	∠	⚡	BATTERY	Lm	📦	🔋
5000 3172	3 W	90°	3,7V - 2200 mAh	Litio Li-ion	500 lm	1	88,45



## LINTERNAS DE ALUMINIO / LAMPE TORCHE ALUMINIUM / ALUMINIUM TORCHES / TORCE IN ALLUMINIO / LANTERNAS DE ALUMÍNIO



Pilas no incluidas  
Batteries not included

Ref	W	Lm					
5000 3110	3W	120 lm	Ø3,7 x 15 cm	1	10	12,56	✓



Pilas no incluidas  
Batteries not included

Ref	W	Lm					
5000 3112	3W	140 lm	Ø5 x 23 cm	1	20	18,97	✓



Pilas no incluidas  
Batteries not included

Ref	W	Lm					
5000 3113	3W	160 lm	Ø5,5 x 25 cm	1	10	23,72	✓

LINTERNA ALUM. "ZOOM" LED / LAMPE ALUM. "ZOOM" LED / ALUMINIUM "ZOOM" LED TORCH  
TORCIA ALLUMINIO "ZOOM" LED / LANTERNA ALUM. "ZOOM" LED

Pilas no incluidas  
Batteries not included

Ref	W	Lm					
5000 3120	3W	120 lm	Ø3 x 12 cm	1	12	11,42	✓



Pilas no incluidas  
Batteries not included

Ref	W	Lm					
5000 3121	3W	140 lm	Ø4 x 22 cm	1	20	18,77	✓

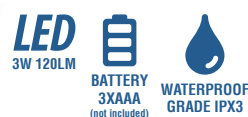
LINTERNA ALUM. "MINI" LED / LAMPE ALUM. "MINI" LED / ALUMINIUM "MINI" LED TORCH  
TORCIA ALLUMINIO "MINI" LED / LANTERNA ALUM. "MINI" LED

Pilas no incluidas  
Batteries not included

Ref	W	Lm					
5000 3122	1W	40 lm	Ø1,8 x 9,5 cm	1	20	4,99	✓



LUZ LED FARO BICICLETA 3 POSICIONES / LAMPE LED FEU BICYCLETTE 3 FONCTIONS / BICYCLE LED HEADLIGHT 3 FUNCTIONS  
 LUCE LED FARO BICICLETTA, 3 FUNZIONI / LUZ LED FAROL BICICLETA 3 FUNÇÕES



**5LED**  
RUNTIME  
5-10 HRS

**3**  
FUNCTION

100%  
50%  
FLASHING

BATTERY  
3XAAA  
(not included)

WATERPROOF  
GRADE IPX3



Pilas no incluidas  
Batteries not included

Ref	Nº LED	Grid	Box	Stack	Checkmark
5000 3151	5	1	12	5,10	✓



Expositor / Presentoir / Display stand / Espositore / Expositor

Ref	Down Arrow	Box	Stack
0450 3151	12	1	61,15

LUZ LED ROJA TRASERA BICICLETA 7 FUNCIONES / LED BICYCLETTE ARRIÈRE ROUGE 7 FONCTIONS / BACK RED LED LIGHT FOR BICYCLE WITH 7 FUNCTIONS  
 LUCE LED ROSSA PER LATO POSTERIORE BICICLETTA, 7 FUNZIONI / LUZ LED VERMELHA TRASEIRA BICICLETA 7 FUNÇÕES



**9**  
LED

**7**  
FUNCTION

BATTERY  
3XAAA  
(not included)

WATERPROOF  
GRADE IPX3



Pilas no incluidas  
Batteries not included

Ref	Nº LED	Grid	Box	Stack	Checkmark
5000 3152	5	1	12	4,06	✓



Expositor / Presentoir / Display stand / Espositore / Expositor

Ref	Down Arrow	Box	Stack
0450 3152	12	1	48,67

LINTERNA LED CAMPING EN ABS Y GOMA / LAMPE TORCHE LED, EN ABS ET CAOUTCHOUC / LED TORCH FOR CAMPING, FROM ABS AND RUBBER  
 TORCIA LED PER CAMPEGGIO, IN ABS E GOMMA / LANTERNA LED, P/ CAMPING EM ABS E BORRACHA



**13**  
LED

BATTERY  
4XLR20  
1X4R25/6V  
(not included)



Pilas no incluidas  
Batteries not included

Ref	Nº LED	Grid	Box	Stack	Checkmark
5000 3147	13	1	6	13,42	✓



LINTERNA LED DE CABEZA "ZOOM", 3 FUNCIONES / LAMPE LED TÊTE "ZOOM", 3 FONCTIONS / LED TORCH, HEAD "ZOOM", 3 FUNCTIONS  
TORCIA LED CON TESTA "ZOOM", 3 FUNZIONI / LANTERNA LED DE CABEÇA "ZOOM", 3 FUNÇÕES

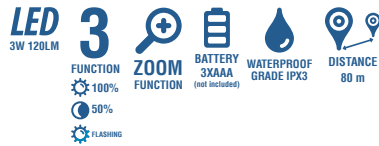

Pilas no incluidas  
Batteries not included

Ref	W	Lm				
5000 3131	3W	120 lm	1	12	11,91	✓



Expositor / Presentoir / Display stand / Espositore / Expositor

Ref			
0450 3131	12	1	144,54

LINTERNA 19 LED DE CABEZA 3W 3 FUNCIONES / LAMPE 19 LED TÊTE 3W, 3 FONCTIONS / 19 LED TORCH, HEAD 3W, 3 FUNCTIONS  
TORCIA 19 LED CON TESTA "ZOOM", 3 FUNZIONI / LANTERNA 19 LED DE CABEÇA 3W, 3 FUNÇÕES

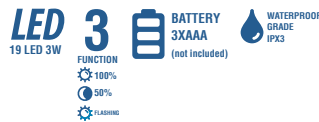

Pilas no incluidas  
Batteries not included

Ref	W	Nº LED				
5000 3132	3W	19	1	12	6,40	✓



Expositor / Presentoir / Display stand / Espositore / Expositor

Ref			
0450 3132	12	1	78,05

LINTERNA 9 LED ALUMINIO, COLORES / LAMPE 9 LED ALUMINIUM, COULEURS / ALUMINIUM 9 LED TORCH, COLOURS  
TORCIA DI ALLUMINIO CON 9 LED, COLORI / LANTERNA 9 LED ALUMÍNIO, CORES



Pilas no incluidas  
Batteries not included

Ref	Nº LED					
5000 3125	9	Ø 2,7 x 10 cm	1	12	4,68	✓



Expositor / Presentoir / Display stand / Espositore / Expositor

Ref			
0450 3125	12	1	56,16



LÁMPARA 24 LED REDONDA IMÁN/GANCHO / AMPOULE 24 LED RONDE AIMANT/CROCHET / ROUND 24 LED LAMP MAGNET/HOOK  
LAMPADA TONDA 24 LED, MAGNETE /GANCIO / LÁMPADA 24 LED REDONDA ÍMÃ/GANCHO



**24LED**  
MAGNET  
HOOK?  
BATTERY  
3XAAA  
(not included)



5000 2004

Pilas no incluidas  
Batteries not included

Ref	Nº LED				
5000 3141	24	1	12	6,14	✓



Expositor / Presentoir / Display stand / Espositore / Expositor

Ref			
0450 3141	12	1	73,63

LÁMPARA 72 LED RECTANGULAR IMÁN/GANCHO / ANPOULE 72 LED RECTANGULAIRE AIMANT/CROCHET / RECTANGULAR 72 LED LAMP MAGNET/HOOK  
LAMPADA 72 LED RETTANGOLARE MAGNETE/GANCIO / LÁMPADA 72 LED RETANGULAR ÍMÃ / GANCHO



**72 LED**  
MAGNET  
HOOK?  
BATTERY  
4XAA  
(not included)



5000 2003

Pilas no incluidas  
Batteries not included

Ref	Nº LED				
5000 3145	72	1	12	14,51	✓



Expositor / Presentoir / Display stand / Espositore / Expositor

Ref			
0450 3145	12	1	174,10





LUZ DE TRABAJO 60 LED / LUMIÈRE DE TRAVAIL 60 LED / 60 LED WORKING LIGHT / LUCE DA LAVORO 60 LED / LUZ DE TRABALHO 60 LED

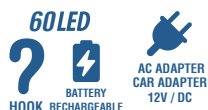

Ref	Nº LED				
5000 3146	60	1	4	30,66	✓

LINTERNA COB LED MAGNÉTICA DE BOLSILLO / LAMPE MAGNÉTIQUE LED COB LUMIÈRE TRAVAIL / MAGNETIC COB LED FLASHLIGHT WORK LIGHT  
TORCIA A LED MAGNETICA COB LUCE LAVORO / LANTERNA COB LED LUZ TRABALHO MAGNETICO

- Resistencia ante el agua y los golpes / Waterproof & shock resistant
- Pilas 3 x AAA incluidas / 3xAAA batteries included
- Magnética / Magnetic
- Distancia: 10 metros / Distance: 10 metres



ES Ideal para el uso profesional de mecánicos, conductores, vigilantes, etc. Diseñado con un cuerpo en ABS color negro mate, siendo ligero, resistente al agua y a impactos.

FR Idéal pour l'utilisation professionnelles des mécaniciens, chauffeurs, gardiens, etc. Conçue avec un corps en ABS noir mat, léger, résistant à l'eau et aux impacts.

EN Ideal for maintenance professionals, mechanics, drivers, supervisor etc. Designed with a lightweight, heavy-duty ABS body that is water-resistant and impact-resistant in a matte black colour.

IT Ideale per l'uso professionale per meccanici, conducenti, guardie, ecc. È progettata con corpo in ABS, in colore nero opaco, essendo leggero, impermeabile e resistente agli urti.

PT Ideal para o uso profissional de mecânicos, condutores, vigilantes, etc. Desenhado com um corpo em ABS cor negro mate, sendo ligeiro, resistente à água e a impactos.

Ref	W		Lm	◁				
5000 3105	3W	110 x 55 x 21 mm	150 lm	180°	1	12	16,85	✓





	ES	FR	EN	IT	PT
<b>Ref</b>	Referencia	Référence	Reference	Riferimento	Referência
	Unidad mínima de venta	Nombre d'unités minimum de vente	Minimum sale unit	Quantitativo minimo di vendita	Unidade mínima de venda
	Packing	Conditionnement	Packing	Imballo	Embalagem
	Precio	Prix	Price	Prezzo	Preço
	Blister	Blister	Blister	Blister	Blister
	Descripción	Description	Description	Descrizione	Descrição
	Contenido	Contenu	Contains	Contenuto	Conteúdo
	Colores	Couleur	Color	Colore	Cores
<b>A-V~</b>	Amperios - Voltios	Ampères - Volts.	Amperes - Volts	Ampere - Volt	Ampères - Volts
<b>A</b>	Amperios	Ampères	Amperes	Ampere	Ampères
<b>VÍAS</b>	Vías	Voies	Paths	Uscite	Vias
<b>W</b>	Vatios	Watt	Watt	Watt	Watt
	Rosca	Filetage	Thread	Filettatura	Rosca
<b>V-HZ</b>	Voltios - Hercios	Volts - Hertz	Volts - Hertz	Volt - Hertz	Volts - Hertz
	Peso	Poids	Weight	Peso	Peso
<b>V-AC-HZ</b>	V-AC-HZ	V-AC-HZ	V-AC-HZ	V-AC-HZ	V-AC-HZ
	Diámetro	Diamètre	Diameter	Diametro	Diâmetro
	Medidas	Mesures	Measurements	Misure	Medidas
	Longitud	Longueur	Length	Lunghezza	Comprimento
<b>IP</b>	Índice de protección	Indice de protection	Safety rate	Indice di protezione	Índice de proteção
<b>Lm</b>	Lúmenes	Lumens	Lumens	Lumen	Lumens
	Ángulo	Angle	Angle	Angolo	Ângulo
<b>Nº LED</b>	Nº Led	Nº Led	LED Number	Nº Led	Nº Led
<b>MODEL</b>	Modelo	Modèle	Model	Modello	Modelo
	Tiempo de carga	Temps de charge	Charge time	Tempo de carica	Tempo de carga
	Voltaje	Voltage	Voltage	Voltaggio	Voltagem





●.cofan





[www.cofan.es](http://www.cofan.es)

# ÍNDICE / INDEX / CONTENTS

## INDICE / ÍNDICE



### 737

MATERIAS PELIGROSAS / MATIÈRES DANGEREUSES  
DANGEROUS MATERIAL / MATERIALE PERICOLOSI  
MATÉRIAS PERIGOSAS



### 752

ADVERTENCIA / AVERTISSEMENT / WARNING  
AVVERTIMENTO / AVISO



### 738

EVACUACIÓN / ÉVACUATION / EVACUATION  
EVACUAZIONE / EVACUAÇÃO



### 757

COMBINADAS / ASSOCIÉS / COMBINED  
COMBINATI / COMBINADAS



### 740

PROHIBICIÓN / INTERDICTION / PROHIBITION  
DIVIETI / PROIBIÇÃO



### 758

SEÑALES EN CATALÁN / SIGNAUX EN CATALAN  
SIGNALS IN CATALAN / SEGNALETICA IN SPAGNOLO  
SINAIS EM CATALÃO



### 745

OBLIGACIÓN / OBLIGATION / OBLIGATION  
OBBLIGO / OBRIGAÇÃO



### 760

INFORMATIVAS / INFORMATION / INFORMATION  
INFORMATIVI / INFORMAÇÃO



### 750

SOCORRO / SECOURS / SECURITY  
SOCCORSO / SOCORRO



### 761

ACCESORIAS / ACCESSOIRES / ACCESSORIES  
ACCESSORI / ACESSÓRIOS



**762**

CARTELES PARA OBRAS / AFFICHAGES POUR TRAVAUX  
CONSTRUCTION SIGNS / INDICAZIONE PER IL LAVORO  
SINAIS DE CONSTRUÇÃO



**775**

SEÑALIZACIÓN ESPECIAL / SIGNALÉTIQUE SPÉCIALE  
SPECIAL SIGNS / SEGNALETICA SPECIALE  
SINALIZAÇÃO ESPECIAL



**762**

RECICLAJE Y ESPECIALES / RECYCLAGE ET SPÉCIAUX  
RECYCLING AND SPECIALS / RICICLAGGIO E SPECIALI  
RECICLAGEM E ESPECIAIS



**779**

ACCESORIOS OFICINA / ACCESSOIRES DE BUREAU  
OFFICE ACCESSORIES / ACCESSORI OFFICINA  
ACESSÓRIOS DE ESCRITÓRIO



**763**

SEÑALIZACIÓN ESPECIAL / BALISAGE / SIGNPOSTING  
SEGNALETICA SPECIALE / SEGNALETICA SPECIALE



**780**

ESPEJOS / MIROIRS / MIRRORS  
SPECCHI / ESPELHOS



**764**

ACCESORIOS / ACCESSOIRES / OFFICE  
ACCESSORI / ACESSÓRIOS



**782**

GLOSARIO / GLASSAIRE / GLOSSARY  
GLOSSARIO / GLOSSÁRIO



**765**

CINTAS Y LÁMPARAS DE BALIZAMIENTO  
SIGNALETIQUE ET LAMPES DE BALISAGE  
WARNING TAPES AND SIGNPOSTING LAMP  
NASTRI E FARI LAMPADE  
FITAS E LÂMPADAS DE SINALIZAÇÃO



**767**

SEÑALIZACIÓN PARA AUTOMOCIÓN  
SIGNALETIQUE POUR SECTEUR AUTOMOBILE  
SIGNS FOR AUTOMOBILE INDUSTRY  
SEGNALETICA MEZZI  
SINALIZAÇÃO PARA A INDÚSTRIA AUTOMÓVEL

ES La normativa UNE 23035-4 de Diciembre de 2003, obliga a las señales a ciertas calidades de intensidad lumínica y de resistencia ante la atenuación del pigmento. Tanto las tintas, como el PVC Fotoluminescente utilizados en la realización de nuestras señales cumplen ampliamente dicha normativa. Dado que la señalización de seguridad puede contribuir a salvar vidas, y es obligatoria, utilice la mejor señalización posible. Recomendaciones de Uso: Tamaños mínimos a utilizar en función de los metros.

FR La norme UNE 23035-4 de décembre 2003, oblige la présence de signaux à une certaine intensité lumineuse et de résistance avant l'atténuation du pigment. Les encres, comme le PVC phosphorescent utilisés dans la réalisation de nos signaux accomplissent largement cette réglementation. Puisque la signalisation de sécurité peut contribuer à sauver des vies et est obligatoire, utilisez la meilleure signalisation possible. Recommandations d'Utilisation: Tailles minimales à utiliser en fonction des mètres.

EN The regulations UNE 23035-4, of December 2003, oblige us to use signs of certain quality of light intensity and resistance to their reduction. Inks as well as used luminescent PVC fulfill these regulations. Since safety signs can help save lives, and you are obliged to use them, use the best possible sign. Recommended Use: Minimum sizes to use depending on the distance in meters.

IT La normativa UNE 23035-4, del Dicembre 2003, costringe ad utilizzare segnaletiche con una certa intensità luminosa e resistenti ad una loro attenuazione. Sia gli inchiostri che il PVC fotoluminescente utilizzati nella realizzazione della nostra segnaletica rispettano pienamente questa normativa. Dal momento che i segnali di sicurezza possono contribuire a salvare vite umane, è necessario utilizzare quanto di migliore sia possibile. Raccomandazioni per l'uso: Taglie minime da utilizzare in funzione dei metri.

PT A legislação UNE 23035-4, de Dezembro de 2003, obriga que os sinais tenham certas qualidades de intensidade de luz e de resistência frente à atenuação do pigmento. Ambas as tintas, como o PVC fotoluminescente, utilizados na realização dos nossos sinais cumprem integralmente estes regulamentos. Uma vez que a sinalização de segurança pode ajudar a salvar vidas, e é obrigatória, use a melhor sinalização possível. Recomendações para o Uso: Tamanhos mínimos para usar dependendo dos metros.

DISTANCIA MÁXIMA PARA SEÑALIZACIÓN / DISTANCE MAXIMALE POUR LA SIGNALISATION / MAXIMUM DISTANCE FOR PLACING SIGNS  
DISTANZA MASSIMA PER SEGNALETICA / DISTÂNCIA MÁXIMA PARA A SINALIZAÇÃO

DIN A3	DIN A4	DIN A5	DIN A6
13 m	10 m	7 m	4 m

#### ES Ejemplo de referencias:

Material: "LU" Luminescente, medida: 420x297. Señal: EV09	REF:	EV09 LU 420 297
Material: "PL" Poliestireno, medida: 420x297. Señal: P31	REF:	P31 PL 420 297
Material: "AD" Adhesivo, medida: 148x148. Señal: P01	REF:	P01 AD 148 148
Material: "GL" Glasspack, medida 250x62. Señal: I01	REF:	I01 GL 250 62
Codificación: Referencia + Material + Medida		

#### FR Exemple de références:

Matériel: "LU" Luminescente, mesure: 420x297. Signal: EV09	REF:	EV09 LU 420 297
Matériel: "PL" Polystyrène, mesure: 420x297. Signal: P31	REF:	P31 PL 420 297
Matériel: "AD" Adhésif, mesure: 148x148. Signal: P01	REF:	P01 AD 148 148
Matériel: "GL" Glasspack, mesure: 250x62. Signal: I01	REF:	I01 GL 250 62
Code: Référence + Matériel + Mesure		

#### EN Example of references:

Material: "LU" Luminescent, measurement: 420x297. Sign: EV09	REF:	EV09 LU 420 297
Material: "PL" Polystyrene, measurement: 420x297. Sign: P31	REF:	P31 PL 420 297
Material: "AD" Adhesive, measurement: 148x148. Sign: P01	REF:	P01 AD 148 148
Material: "GL" Glasspack, measurement: 250x62. Sign: I01	REF:	I01 GL 250 62
Code: Reference + Material + Measurement		

#### IT Esempi di riferimenti:

Materiale: "LU" Luminescente, misura: 420x297. Cod: EV09	REF:	EV09 LU 420 297
Materiale: "PL" Polistirolo, misura: 420x297. Cod: P31	REF:	P31 PL 420 297
Materiale: "AD" Adesivo, misura: 148x148. Cod: P01	REF:	P01 AD 148 148
Materiale: "GL" Confezione in vetro, misura: 250x62. Cod: I01	REF:	I01 GL 250 62
Referenza: Codice + Materiale + Misura		

#### PT Exemplo de referências:

Material: "LU" Luminescente, medida: 420x297. Sinal: EV09	REF:	EV09 LU 420 297
Material: "PL" Poliestireno, medida: 420x297. Sinal: P31	REF:	P31 PL 420 297
Material: "AD" adesivo, medida: 148x148. Sinal: P01	REF:	P01 AD 148 148
Material: "GL" Glasspack, medida 250x62. Sinal: I01	REF:	I01 GL 250 62
Codificação: Referência + Material + Medida		

## TARIFA SEÑALES / TARIF DES PANNEAUX / SIGNPOSTING TARIFF / TARIFFE / TARIFA DE SINALIZAÇÃO

	AD	PL	LU
717 x 297 mm	.	<b>20,13</b>	.
507 x 210 mm	.	<b>15,08</b>	.
420 x 297 mm	.	<b>8,15</b>	<b>9,17</b>
400 x 100 mm	.	.	<b>8,06</b>
297 x 210 mm	<b>3,50</b>	<b>5,70</b>	<b>6,47</b>
250 x 170 mm	<b>2,95</b>	.	.
210 x 148 mm	<b>2,40</b>	<b>3,65</b>	<b>4,19</b>

	AD	PL	LU
175 x 120 mm	<b>2,15</b>	.	.
148 x 105 mm	<b>1,52</b>	<b>2,76</b>	<b>3,12</b>
297 x 297 mm	.	<b>7,62</b>	<b>8,56</b>
210 x 210 mm	<b>3,00</b>	<b>5,16</b>	<b>5,83</b>
148 x 148 mm	<b>2,04</b>	<b>3,20</b>	<b>3,58</b>
105 x 105 mm	<b>1,44</b>	<b>2,58</b>	<b>2,90</b>

### Tarifa Glasspack

	GL
250 x 62 mm	<b>2,28</b>
175 x 45 mm	<b>1,52</b>
62 x 62 mm	<b>1,15</b>

SEÑALIZACIÓN MATERIAS PELIGROSAS / SIGNALISATION MATIÈRES DANGEREUSES / DANGEROUS MATERIAL SIGNS  
SEGNALÈTICA MATERIALE PERICOLOSI / SINALIZAÇÃO MATÉRIAS PERIGOSAS

Adhesivos - materiales peligrosos / Adhésifs - matériaux dangereux / Adhesive - dangerous material / Adesivi - materiali pericolosi / Adesivo - material perigoso

Medidas / Measurement / Sizes / Misure / Medidas:  
100 x 100 mm / 300 x 300 mm

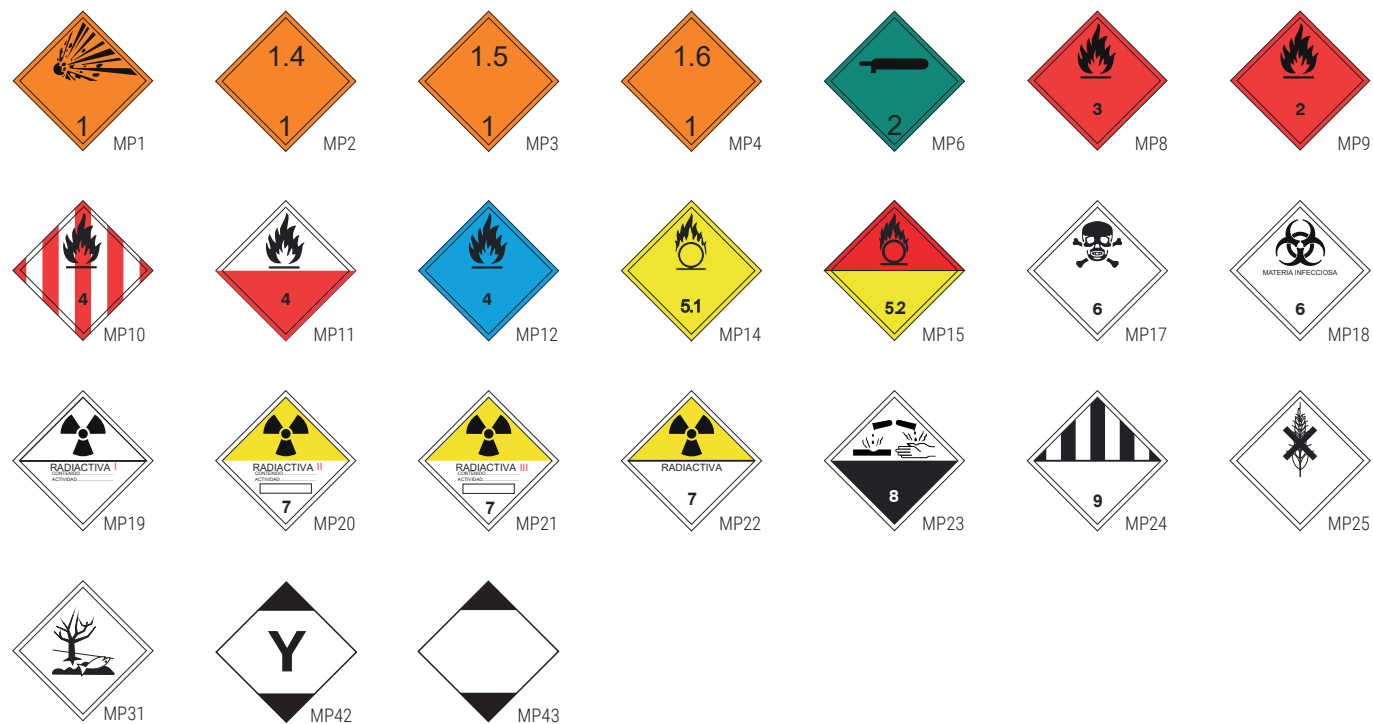



300 x 300 mm

105 x 90 mm

150 x 105 mm



			
105 x 90 mm	1		<b>3,99</b>
100 x 100 mm	1		<b>2,25</b>
150 x 105 mm	1		<b>2,45</b>
300 x 300 mm	1		<b>4,95</b>

ADHESIVOS RESIDUOS - TÓXICOS / ADHÉSIFS RÉSIDUS - TOXIQUES / ADHESIVE - TOXIC WASTE  
ADESIVI RESIDUI - TOSSICI / ADESIVO - RESÍDUOS TÓXICOS

Medidas / Measurement / Sizes / Misure / Medidas: 100 x 100 mm



			
100 x 100 mm		1	<b>2,25</b>



EVACUACIÓN / ÉVACUATION / EVACUATION / EVACUAZIONE / EVACUAÇÃO

LUMINESCENTE / PHOSPHORESCENT / LUMINESCENT / LUMINESCENTE / LUMINESCENTE

Medidas / Measurement / Sizes / Misure / Medidas:

420 x 297 mm (DIN A-3) / 297 x 210 mm (DIN A-4) / 210 x 148 mm (DIN A-5) / 148 x 105 mm (DIN A-6)

UNE-23035-4

 SALIDA DE EMERGENCIA	 SALIDA DE EMERGENCIA	 SALIDA DE EMERGENCIA	 SALIDA DE EMERGENCIA	 ESCALERA DE EMERGENCIA	 ESCALERA DE EMERGENCIA
EV01	EV02	EV42	EV43	EV49	EV50
 EV48	 SALIDA DE EMERGENCIA DESLIZAR PARA ABRIR	 SALIDA DE EMERGENCIA DESLIZAR PARA ABRIR	 SALIDA DE EMERGENCIA PRESIONE LA BARRA PARA ABRIR	 SALIDA DE EMERGENCIA EMPUJAR PARA ABRIR	 BOTIQUÍN
EV48	EV20	EV21	EV03	EV57	EV22
 BOTIQUÍN	 BOTIQUÍN	 PRIMEROS AUXILIOS	 PRIMEROS AUXILIOS	 PRIMEROS AUXILIOS	 PRIMEROS AUXILIOS
EV23	EV24	EV27	EV28	EV29	EV52
 CLÍNICA	 CLÍNICA	 DUCHA DE EMERGENCIA	 LAVAOJOS DE EMERGENCIA	 ROMPER PARA PASAR	 PUNTO DE REUNIÓN
EV54	EV53	EV31	EV30	EV68	EV32
 EV04	 EV05	 EV06	 EV07	 EV08	 EV09
EV04	EV05	EV06	EV07	EV08	EV09
 SALIDA DE EMERGENCIA	 SALIDA DE EMERGENCIA	 EV13	 SALIDA	 EXIT	 SALIDA EXIT
EV10	EV11	EV13	EV14	EV15	EV16
 EV73	 EV74	 EV55	 EV56	 SALIDA DE EMERGENCIA	 SALIDA DE EMERGENCIA
EV73	EV74	EV55	EV56	EV17	EV38
 SALIDA DE EMERGENCIA	 USO EXCLUSIVO SALIDA DE EMERGENCIA	 ESCALERA DE EMERGENCIA	 ESCALERA DE EMERGENCIA	 ESCALERA DE EMERGENCIA	 EV12
EV37	EV51	EV39	EV40	EV41	EV12

EVACUACIÓN / ÉVACUATION / EVACUATION / EVACUAZIONE / EVACUAÇÃO

LUMINESCENTE / PHOSPHORESCENT / LUMINESCENT / LUMINESCENTE / LUMINESCENTE

Medidas / Measurement / Sizes / Misure / Medidas:  
297 x 297 mm / 210 x 210 mm / 148 x 148 mm / 105 x 105 mm

UNE-23035-4



EV01



EV02



EV42



EV43

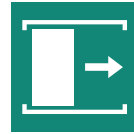

EV20

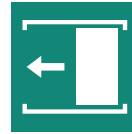

EV21



EV03



EV57



EV18



EV19



EV25



EV26



EV32



EV22



EV23



EV24



EV27



EV28



EV29

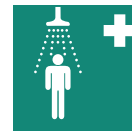

EV31



EV30



EV32

Medidas / Measurement / Sizes / Misure / Medidas:  
400 x 100 mm



EV33



EV34



EV35



EV36



EV58



EV59



EV47



EV44



EV46



EV45



EV75



EV76



EV69

Medidas / Measurement / Sizes / Misure / Medidas:  
297 x 210 (DIN A4)



EV60



EV61



EV62



EV64



EV65



EV66



EV72



EV71



A



B

	Ref				
A	PAN01	210 x 210 mm	1		13,65
B	PAN01	297 x 210 mm	1		13,65

## PROHIBICIÓN / INTERDICTION / PROHIBITION / DIVIETI / PROIBIÇÃO

Medidas / Measurement / Sizes / Misure / Medidas:

420 x 297 mm (DIN A-3) Poliéstireno / 297 x 210 mm (DIN A-4) Poliéstireno o adhesivo / 210 x 148 mm (DIN A-5) Poliéstireno o adhesivo / 148 x 105 mm (DIN A-6) Poliéstireno o adhesivo

**PROHIBIDO EL PASO**

P01

**ALTO NO PASAR**

P02

**ENTRADA PROHIBIDA A PERSONAS AJENAS A LA EMPRESA SIN AUTORIZACIÓN**

P42

**ENTRADA PROHIBIDA SALVO PERSONAL DE MANTENIMIENTO**

P43

**PROHIBIDO EL PASO A TODA PERSONA AJENA A LA OBRA**

P48

**NO UTILIZAR LA MAQUINA SIN AUTORIZACION**

P55

**PROHIBIDO EL PASO A TODA PERSONA AJENA A ESTA OBRA**

P03

**PROHIBIDO EL PASO A TODA PERSONA AJENA A ESTE DEPARTAMENTO**

P04

**PROHIBIDO EL PASO A TODA PERSONA NO AUTORIZADA**

P41

**PROHIBIDO EL PASO A PEATONES**

P05

**CALDERA DE GAS PROHIBIDO EL PASO A TODA PERSONA AJENA AL SERVICIO**

P50

**PERSONAL NO AUTORIZADO**

P51

**PROHIBIDO EL PASO A TODA PERSONA AJENA**

P52

**PROHIBIDO EL PASO A TODA PERSONA AJENA A LA EMPRESA**

P53

**PROHIBIDO PISAR EL CESPED**

P105

**PROHIBIDO PISAR SUELO FRÁGIL**

P06

**PROHIBIDO ACCESO A ESCALERA**

P07

**NO UTILIZAR EN CASO DE EMERGENCIA**

P08

**PROHIBIDO EL PASO CON MARCAPASOS**

P09

**NO UTILIZAR EN CASO DE INCENDIO**

P99

**NO UTILIZAR EN CASO DE EMERGENCIA**

P10

**MONTACARGAS PROHIBIDO A PERSONAS**

P11

**PROHIBIDO EL PASO A CARRETILLAS**

P14

**PROHIBIDO TRANSPORTAR A PERSONAS**

P15

**PROHIBIDO SITUARSE DEBAJO DE LA CARGA**

P32

**PROHIBIDO PERMANECER DEBAJO DE LA GRUA EN FUNCIONAMIENTO**

P56

**PROHIBIDO FUMAR**

P21

**PROHIBIDO FUMAR PELIGRO DE INCENDIO**

P22

**PROHIBIDO FUMAR A PARTIR DE ESTE PUNTO**

P46

**ZONA DE NO FUMADORES**

P47

**PROHIBIDO FUMAR GAS INFLAMABLE**

P54

**PROHIBIDO APAGAR CON AGUA**

P23

**PROHIBIDO ENCENDER FUEGO**

P24

**PROHIBIDO FUMAR Y ENCENDER FUEGO**

P45

**PROHIBIDO PERROS**

P16

**PROHIBIDO ACCIONAR**

P101

**PROHIBIDO ACCIONAR**

P17

**PELIGRO NO CONECTAR HOMBRES TRABAJANDO**

P40

**NO TOCAR**

P18

**PROHIBIDO EL USO DE GANTES**

P96

**PROHIBIDO USAR GANTES DE MALLA**

P97

**PROHIBIDO CÁMARAS FOTOGRÁFICAS**

P20

**PROHIBIDO ACAMPAR**

P28

**PROHIBIDO BAÑARSE**

P37

**PROHIBIDO ARROJAR OBJETOS AL SUELO**

P57

**AGUA NO POTABLE**

P25

**PROHIBIDO COMER Y BEBER**

P26

**PROHIBIDO EL USO DE TELÉFONOS MÓVILES**

P19

PROHIBICIÓN / INTERDICTION / PROHIBITION / DIVIETI / PROIBIÇÃO

Medidas / Measurement / Sizes / Misure / Medidas:

297 x 297 mm Poliestireno / 210 x 210 mm Poliestireno o adhesivo / 148 x 148 mm Poliestireno o adhesivo / 105 x 105 mm Poliestireno o adhesivo



P01



P02



P03



P06



P07



P08



P09



P10



P11



P14



P15



P32



P56



P21



P23



P24



P16



P17



P18



P20



P28



P37



P57



P25



P26



P19



P33



P34

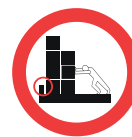

P35



P38



P49



P29



P36



P39



P44



P12



P13



P27



P58



P59



P60



P61



P62



P64



P65



P66



P67



P68



P69



P77



P78



P86



P87



P88

## PROHIBICIÓN / INTERDICTION / PROHIBITION / DIVIETI / PROIBIÇÃO

Medidas / Measurement / Sizes / Misure / Medidas:

420 x 297 mm (DIN A-3) Poliestireno / 297 x 210 mm (DIN A-4) Poliestireno o adhesivo / 210 x 148 mm (DIN A-5) Poliestireno o adhesivo / 148 x 105 mm (DIN A-6) Poliestireno o adhesivo

PROHIBIDO  
DEJAR  
MERCANCÍA

P33

PROHIBIDO  
TREPAR A  
RACKS

P34

PROHIBIDO COLOCAR  
OBJETOS SOBRE  
PLATAFORMA DE TRABAJO  
SIN RODAPIE

P35

NO  
EMPUJAR

P92

PROHIBIDO  
SALTAR  
LAS ZANJAS

P38

PROHIBIDO  
APARCAR

P29

SE AVISA  
GRUA

P30

VADO  
PERMANENTE

P31

CIRCULACIÓN  
PROHIBIDA

P36

CIRCULACIÓN  
PROHIBIDA A TODOS  
LOS VEHÍCULOS  
DE MOTOR

P89

VELOCIDAD  
MÁXIMA

P39

PROHIBIDO  
ENGRASAR  
LAS MÁQUINAS EN  
FUNCIONAMIENTO

P49

PROHIBIDO EL  
PASO DE  
VEHÍCULOS

P12

PROHIBIDO  
CIRCULAR  
EN BICICLETA

P13

VELOCIDAD  
MÁXIMA

P106

NO CERRAR  
CON LLAVE

P27

PROHIBIDO TRABAJAR  
SIN EL DISPOSITIVO  
DE SEGURIDAD

P58

PROHIBIDO  
COLOCAR  
CARGAS PESADAS

P90

ALTURA MÁXIMA  
PERMITIDA

P44

PROHIBIDO CONSUMIR  
BEBIDAS ALCOHÓLICAS

P61

PROHIBIDO  
COMER  
HELADOS

P62

PROHIBIDO  
EL PASO  
PROPIEDAD  
PRIVADA

P63

PROHIBIDO  
PATINAR

P64

PROHIBIDO PERMANECER EN  
EL RADIO DE ACCIÓN  
DE LA MAQUINARIA

P65

PROHIBIDO  
PERMANECER  
EN ESTE LUGAR

P66

PROHIBIDO  
PERMANECER DEBAJO  
DE LA CARGA

P59

PROHIBIDO JUGAR  
A LA PELOTA

P60

PROHIBIDO  
TIRAR BASURAS  
Y ESCOMBROS

P104

PROHIBIDO  
PESCAR

P67

PROHIBIDO  
SENTARSE

P93

PROHIBIDO  
PISAR

P94

PROHIBIDO  
SALTAR LA VALLA

P108

PROHIBIDO  
BALANCEAR  
LA SILLA

P98

PROHIBIDO  
HACER FOTOS O  
GRABAR VIDEO

P102

PROHIBIDO SUBIR  
EN TRANSPALET  
DE ALMACÉN

P69

PROHIBIDO EL PASO  
A VEHÍCULOS DE  
DESCARGA

P73

PROHIBIDO  
APARCAR  
CAMIONES

P74

UNA PERSONA  
POR MÁQUINA

P70

NO TIRAR  
DEL CABLE

P71

PROHIBIDO  
TOCAR  
EL CLAXÓN

P72

PROHIBIDO  
APARCAR  
ZONA DE CARGA  
Y DESCARGA

P75

ALTO  
ACCESO SOLO  
PERSONAL AUTORIZADO

P76

PROHIBIDO  
GIRAR  
A LA DERECHA

P77

PROHIBIDO  
GIRAR  
A LA IZQUIERDA

P78

PROHIBIDO REPARAR  
LA MÁQUINA EN  
FUNCIONAMIENTO

P68

PROHIBIDO  
COMER Y BEBER  
EXCEPTO EN ZONAS  
HABILITADAS

P100



PROHIBICIÓN / INTERDICTION / PROHIBITION / DIVIETI / PROIBIÇÃO

Medidas / Measurement / Sizes / Misure / Medidas:

420 x 297 mm (DIN A-3) Poliestireno / 297 x 210 mm (DIN A-4) Poliestireno o adhesivo / 210 x 148 mm (DIN A-5) Poliestireno o adhesivo / 148 x 105 mm (DIN A-6) Poliestireno o adhesivo



**PROHIBIDO DEPOSITAR MATERIALES**  
MANTENER LIBRE EL PASO

P79



**PROHIBIDO APARCAR**  
LLAMAMOS GRUA

P80



**PROHIBIDO EL USO DE OBJETOS METÁLICOS Y RELOJES**

P81



**PROHIBIDA LA ENTRADA A PERSONAL NO AUTORIZADO AMANTO**

P82



**PROHIBIDO EXCREMENTOS**

P83



**PROHIBIDO EL ACCESO Y ESTACIONAMIENTO DE MOTOS**

P84



**PROHIBIDO TRANSITAR SOBRE MERCANCÍAS**

P85



**PROHIBIDO LANZARSE DE CABEZA**

P86



**ENTRADA PROHIBIDA A VEHÍCULOS**

P87



**PROHIBIDO UTILIZAR EL ASCENSOR A MENORES DE 14 AÑOS NO ACOMPANADOS**

P88



**PROHIBIDO USAR EL ANDAMIAJE INCOMPLETO**

P95



**PROHIBIDO REPOSTAR CON EL MOTOR EN MARCHA**

P103

Medidas / Measurement / Sizes / Misure / Medidas:

420 x 297 mm (DIN A-3) Poliestireno / 297 x 210 mm (DIN A-4) Poliestireno

**PROHIBIDO EL PASO**

P01T

**ALTO NO PASAR**

P02T

**ENTRADA PROHIBIDA A PERSONAS AJENAS A LA EMPRESA SIN AUTORIZACIÓN**

P42T

**ENTRADA PROHIBIDA SALVO PERSONAL DE MANTENIMIENTO**

P43T

**PROHIBIDO EL PASO A TODA PERSONA AJENA A LA OBRA**

P48T

**NO UTILIZAR LA MÁQUINA SIN AUTORIZACIÓN**

P55T

**PROHIBIDO EL PASO A TODA PERSONA AJENA A ESTA OBRA**

P03T

**PROHIBIDO EL PASO A TODA PERSONA AJENA A ESTE DEPARTAMENTO**

P04T

**PROHIBIDO EL PASO A TODA PERSONA NO AUTORIZADA**

P41T

**PROHIBIDO EL PASO A PEATONES**

P05T

**CALDERA DE GAS PROHIBIDO EL PASO A TODA PERSONA AJENA AL SERVICIO**

P50T

**PERSONAL NO AUTORIZADO**

P51T

**PROHIBIDO EL PASO A TODA PERSONA AJENA**

P52T

**PROHIBIDO EL PASO A TODA PERSONA AJENA A LA EMPRESA**

P53T

**PROHIBIDO PISAR SUELO FRÁGIL**

P06T

**PROHIBIDO ACCESO A ESCALERA**

P07T

**NO UTILIZAR EN CASO DE EMERGENCIA**

P08T

**PROHIBIDO EL PASO CON MARCAPASOS**

P09T

**MONTACARGAS PROHIBIDO A PERSONAS**

P11T

**PROHIBIDO EL PASO A CARRETTILLAS**

P14T

**PROHIBIDO TRANSPORTAR A PERSONAS**

P15T

**PROHIBIDO SITUARSE DEBAJO DE LA CARGA**

P32T

**PROHIBIDO PERMANECER DEBAJO DE LA GRÚA EN FUNCIONAMIENTO**

P56T

**PROHIBIDO FUMAR**

P21T

**PROHIBIDO FUMAR PELIGRO DE INCENDIO**

P22T

**PROHIBIDO FUMAR A PARTIR DE ESTE PUNTO**

P46T

**ZONA DE NO FUMADORES**

P47T

**PROHIBIDO FUMAR GAS INFLAMABLE**

P54T

**PROHIBIDO APAGAR CON AGUA**

P23T

**PROHIBIDO FUMAR Y ENCENDER FUEGO**

P45T

**PROHIBIDO ENCENDER FUEGO**

P24T

**PROHIBIDO PERROS**

P16T

**PROHIBIDO ACCIONAR**

P17T

**PELIGRO NO CONECTAR HOMBRES TRABAJANDO**

P40T

**NO TOCAR**

P18T

## PROHIBICIÓN / INTERDICTION / PROHIBITION / DIVIETI / PROIBIÇÃO

Medidas / Measurement / Sizes / Misure / Medidas:

420 x 297 mm (DIN A-3) Poliestireno / 297 x 210 mm (DIN A-4) Poliestireno

PROHIBIDO  
CÁMARAS  
FOTOGRAFICAS

P20T

PROHIBIDO  
ACAMPAR

P28T

PROHIBIDO  
BAÑARSE

P37T

PROHIBIDO ARROJAR  
OBJETOS AL SUELO

P57T

AGUA NO  
POTABLE

P25T

PROHIBIDO  
COMER Y BEBER

P26T

PROHIBIDO EL  
USO DE TELÉFONOS  
MÓVILES

P19T

PROHIBIDO  
DEJAR  
MERCANCÍA

P33T

PROHIBIDO  
TREPAR A  
RACKS

P34T

PROHIBIDO COLOCAR  
OBJETOS SOBRE  
PLATAFORMA DE TRABAJO  
SIN RODAPIÉ

P35T

PROHIBIDO  
SALTAR  
LAS ZANJAS

P38T

PROHIBIDO  
ENGRASAR  
LAS MÁQUINAS EN  
FUNCIONAMIENTO

P49T

PROHIBIDO  
APARCAR

P29T

SE AVISA  
GRÚA

P30T

CIRCULACIÓN  
PROHIBIDA

P36T

PROHIBIDO EL  
PAÑO DE  
VEHÍCULOS

P12T

PROHIBIDO  
CIRCULAR  
EN BICICLETA

P13T

NO CERRAR  
CON LLAVE

P27T

PROHIBIDO TRABAJAR  
SIN EL DISPOSITIVO  
DE SEGURIDAD

P58T

PROHIBIDO  
PERMANECER  
DEBAJO DE  
LA CARGA

P59T

PROHIBIDO JUGAR  
A LA PELOTA

P60T

PROHIBIDO  
CONSUMIR  
BEBIDAS  
ALCOHÓLICAS

P61T

PROHIBIDO  
COMER  
HELADOS

P62T

PROHIBIDO  
EL PASO  
PROPIEDAD  
PRIVADA

P63T

PROHIBIDO  
PATINAR

P64T

PROHIBIDO  
PERMANECER EN  
EL RADIO DE ACCIÓN  
DE LA MAQUINARIA

P65T

PROHIBIDO  
PERMANECER  
EN ESTE LUGAR

P66T

PROHIBIDO  
PESCAR

P67T



PROHIBIDO REPARAR  
LA MÁQUINA EN  
FUNCIONAMIENTO

P68T

PROHIBIDO SUBIR  
EN TRANSPALET  
DE ALMACÉN

P69T

SEÑAL ALUMINIO VADO PERMANENTE / SIGNAL ALUMINIUM / ALUMINIUM SIGN NO PARKING  
SEGNALETICA IN ALLUMINIO DIVIETO DI SOSTA / SINAL DE ALUMÍNIO NÃO ESTACIONAR

Ref				
2120 1009	297 x 210 mm (DIN A4)	1	1	8,44
2120 1010	420 x 297 mm (DIN A3)	1	1	12,22

OBLIGACIÓN / OBLIGATION / OBLIGATION / OBBLIGO / OBRIGAÇÃO

Medidas / Measurement / Sizes / Misure / Medidas:

420 x 297 mm (DIN A-3) Poliestireno o adhesivo / 297 x 210 mm (DIN A-4) Poliestireno o adhesivo / 210 x 148 mm (DIN A-5) Poliestireno o adhesivo / 148 x 105 mm (DIN A-6) Poliestireno o adhesivo



OBLIGATORIO EL USO DEL CASCO

001



USO OBLIGATORIO DE CASCOS

002



USO OBLIGATORIO DE PROTECTOR AUDITIVO

004



USO OBLIGATORIO DE GAFAS

003



USO OBLIGATORIO DE PANTALLA PROTECTORA

004



USO OBLIGATORIO DE GAFAS ANTISALPICADURA

005



USO OBLIGATORIO DE EQUIPO SEMIAUTÓNOMO

091



USO OBLIGATORIO DE MÁSCARA

006



PASO OBLIGATORIO PARA PERSONAS

025



ES OBLIGATORIO LAVARSE LAS MANOS

028



DIRECCIÓN OBLIGATORIA

029



DIRECCIÓN OBLIGATORIA

030



USO OBLIGATORIO DE MÁSCARILLA

007



DESCONECTAR ANTES DE MANTENER O REPARAR

084



USO OBLIGATORIO DE REDECILLA

008



USO OBLIGATORIO DE CASCO Y GAFAS

041



USO OBLIGATORIO DE CASCO Y PANTALLA PROTECTORA

042



USO OBLIGATORIO DE CASCOS Y GAFAS

043



USO OBLIGATORIO DE CASCO, GAFAS Y PROTECTORES AUDITIVOS

044



OBLIGATORIO DE PROTECTOR FIJO

018



OBLIGATORIO CONECTAR A TIERRA

083



USO OBLIGATORIO DE PROTECTOR AJUSTABLE

019



ES OBLIGATORIO SUJETAR LAS BOTELLAS

058



OBLIGATORIO APILAR CORRECTAMENTE

020



NO OBSTRUIR LA PUERTA

021



ES OBLIGATORIO CERRAR LAS PUERTAS

022



USO OBLIGATORIO DE GAFAS O PANTALLA

045



USO OBLIGATORIO RECOGER LOS EXCREMENTOS

096



USO OBLIGATORIO DE GUANTES

009



USO OBLIGATORIO DE GUANTES AISLANTES

010



USO OBLIGATORIO DE GUANTES PARA MANIPULAR HIERRO O CHAPA

046



USO OBLIGATORIO DE CALZADO DE SEGURIDAD

011



USO OBLIGATORIO DE BOTAS DIELECTRICAS

012



SÓLO MERCANCÍAS

023



ES OBLIGATORIO LEER EL MANUAL DE INSTRUCCIONES

093



SÓLO PERSONAS

024

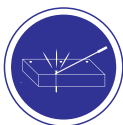

ES OBLIGATORIO ELIMINAR LAS PUNTAS

033



OBLIGATORIO REVISAR CABLES Y CADENAS

034



ES OBLIGATORIO EL USO DE PROTECTOR DE MOLA

035



APAGAR CUANDO NO SE USE

031



OBLIGACIÓN GENERAL

059



USO OBLIGATORIO LEER EL MANUAL DE INSTRUCCIONES

094



USO OBLIGATORIO DE CINTURÓN DE SEGURIDAD

014



USO OBLIGATORIO DE CINTURÓN ANTIVIBRATORIO

015



USO OBLIGATORIO DE ROPA PROTECTORA

016



USO OBLIGATORIO ROPA PROTECTORA

037



USO OBLIGATORIO DE ROPA PROTECTORA

057



CUIDE SU ESPALDA

036



LEA EL MANUAL DE MANTENIMIENTO

095



UTILIZAR EL PASAMANOS

055



ES OBLIGATORIO MANTENER CERRADO

053



OBLIGATORIO DUCHARSE

050



AGUA POTABLE

038



OBLIGATORIO EL USO DE BOZAL

051



USO OBLIGATORIO DE DELANTAL Y MANGUITOS EN PRODUCTOS QUÍMICOS

056



DESCONECTAR EL ENCHUFE DE LA CORRIENTE

081

OBLIGACIÓN / OBLIGATION / OBLIGATION / OBBLIGO / OBRIGAÇÃO























Medidas / Measurement / Sizes / Misure / Medidas:

420 x 297 mm (DIN A-3) Poliéstireno / 297 x 210 mm (DIN A-4) Poliéstireno o adhesivo / 210 x 148 mm (DIN A-5) Poliéstireno o adhesivo / 148 x 105 mm (DIN A-6) Poliéstireno o adhesivo

 <b>USO OBLIGATORIO DE EQUIPO AUTÓNOMO</b> 017	 <b>USO OBLIGATORIO DE MANDIL</b> 048	 <b>USO OBLIGATORIO DE CUBREPIÉS</b> 049	 <b>EQUIPO DE SOLDADURA</b> 032	 <b>USO OBLIGATORIO DE COFIA</b> 047	 <b>OBLIGATORIO LLEVAR LOS PERROS SUJETOS</b> 052
 <b>UTILICEN LA PAPELERA</b> 054	 <b>ABROCHARSE EL CINTURÓN DE SEGURIDAD</b> 039	 <b>USO OBLIGATORIO DE LUCES</b> 040	 <b>USO OBLIGATORIO DE BATA</b> 060	 <b>NO COLOCARSE ENCIMA DE LA CARGA</b> 061	 <b>USO OBLIGATORIO DE CHALECO REFLECTANTE</b> 062
 <b>PASO OBLIGATORIO DE CARRETILLAS</b> 063	 <b>USO OBLIGATORIO DE ROPA AJUSTADA</b> 065	 <b>SÓLO PERSONAL AUTORIZADO</b> 066	 <b>UTILIZAR LAS RODILLAS PARA LEVANTAR PESO</b> 067	 <b>ARO SALVAVIDAS</b> 068	 <b>OBLIGATORIO MANTENER ORDEN Y LIMPIEZA</b> 069
 <b>OBLIGATORIO AVISAR ANTES DE SU FUNCIONAMIENTO</b> 070	 <b>USO OBLIGATORIO DE UNIFORME</b> 076	 <b>USO OBLIGATORIO DE FAJA LUMBAR</b> 077	 <b>OBLIGATORIO MANIPULAR LA MERCANCIA DE FORMA CORRECTA</b> 078	 <b>USO OBLIGATORIO DE GORRA PROTECTORA</b> 079	

Medidas / Measurement / Sizes / Misure / Medidas:

297 x 297 mm Poliéstireno / 210 x 210 mm Poliéstireno o adhesivo / 148 x 148 mm Poliéstireno o adhesivo / 105 x 105 mm Poliéstireno o adhesivo

 001	 002	 003	 004	 005	 006
 028	 029	 030	 018	 007	 008
 041	 042	 043	 044	 019	 058
 020	 021	 022	 023	 045	

OBLIGACIÓN / OBLIGATION / OBLIGATION / OBBLIGO / OBRIGAÇÃO

Medidas / Measurement / Sizes / Misure / Medidas:

297 x 297 mm Poliestireno / 210 x 210 mm Poliestireno o adhesivo / 148 x 148 mm Poliestireno o adhesivo / 105 x 105 mm Poliestireno o adhesivo



009



010



011



012



059



024

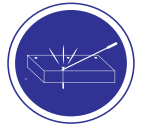

033



034



035



031



036



014



015



016



017



048



056



055



053



050



038



051



052



057



049



032



037



047



025



054



039



040



060



061



062



063



067



068



077



078



081



069



070



## OBLIGACIÓN / OBLIGATION / OBLIGATION / OBBLIGO / OBRIGAÇÃO

Medidas / Measurement / Sizes / Misure / Medidas:

420 x 297 mm (DIN A-3) Poliestireno / 297 x 210 mm (DIN A-4) Poliestireno

USO  
OBLIGATORIO  
DE CASCO

001T

USO  
OBLIGATORIO  
DE CASCOS

002T

USO  
OBLIGATORIO  
DE GAFAS

003T

USO OBLIGATORIO  
DE PANTALLA  
PROTECTORA

004T

USO OBLIGATORIO  
DE GAFAS  
ANTISALPICADURA

005T

USO OBLIGATORIO  
DE MÁSCARA

006T

USO OBLIGATORIO  
DE MASCARILLA

007T

USO OBLIGATORIO  
DE REDECILLA

008T

USO OBLIGATORIO  
DE CASCO Y GAFAS

041

USO OBLIGATORIO  
DE CASCO  
Y PANTALLA  
PROTECTORA

042T

USO OBLIGATORIO  
DE CASCOS Y GAFAS

043T

USO OBLIGATORIO  
DE CASCO, GAFAS Y  
PROTECTORES  
AUDITIVOS

044T

USO OBLIGATORIO  
DE GAFAS O PANTALLA

045T

USO OBLIGATORIO  
DE GUANTES

009T

USO OBLIGATORIO  
DE GUANTES  
AISLANTES

010T

USO OBLIGATORIO  
DE GUANTES PARA  
MANIPULAR  
HIERRO O CHAPA

046T

USO OBLIGATORIO  
DE BOTAS  
DIELECTRICAS

012T

USO OBLIGATORIO  
DE CALZADO  
DE SEGURIDAD

011T

OBLIGACIÓN  
GENERAL

059T

USO OBLIGATORIO  
DE CINTURÓN  
DE SEGURIDAD

014T

USO OBLIGATORIO  
DE CINTURÓN  
ANTIVIBRATORIO

015T

USO OBLIGATORIO  
DE ROPA  
PROTECTORA

016T

USO OBLIGATORIO  
DE DELANTAL Y  
MANGUITOS EN  
PRODUCTOS QUIMICOS

056T

USO OBLIGATORIO  
DE EQUIPO AUTÓNOMO

017T

USO OBLIGATORIO  
DE MANDIL

048T

USO OBLIGATORIO  
DE CUBREPIÉS

049T

EQUIPO DE  
SOLDADURA

032T

USO OBLIGATORIO  
DE COFIA

047T

PASO OBLIGATORIO  
PARA PERSONAS

025T

ES OBLIGATORIO  
LAVARSE LAS MANOS

028T

DIRECCIÓN  
OBLIGATORIA  
→

029T

DIRECCIÓN  
OBLIGATORIA  
←

030T

USO OBLIGATORIO  
DE PROTECTOR FIJO

018T

USO OBLIGATORIO  
DE PROTECTOR  
AJUSTABLE

019T

ES OBLIGATORIO  
ENGANCHAR  
LAS BOTELLAS

058T

OBLIGATORIO APILAR  
CORRECTAMENTE

020T

NO OBSTRUIR  
LA PUERTA

021T

ES OBLIGATORIO  
CERRAR LAS PUERTAS

022T

SÓLO  
MERCANCÍAS

023T

SÓLO  
PERSONAS

024T

ES OBLIGATORIO  
ELIMINAR  
LAS PUNTAS

033T

OBLIGATORIO  
REVISAR  
CABLES Y CADENAS

034T

ES OBLIGATORIO  
EL USO DE  
PROTECTOR DE MOLA

035T

APAGAR  
CUANDO  
NO SE USE

031T

OBLIGACIÓN / OBLIGATION / OBLIGATION / OBBLIGO / OBRIGAÇÃO

Medidas / Measurement / Sizes / Misure / Medidas:  
420 x 297 mm (DIN A-3) Poliestireno / 297 x 210 mm (DIN A-4) Poliestireno

**CUIDE SU  
ESPALDA**

O36T

**UTILIZAR EL  
PASAMANOS**

O55T

**ES OBLIGATORIO  
MANTENER CERRADO**

O53T

**OBLIGATORIO  
DUCHARSE**

O50T

**AGUA  
POTABLE**

O38T

**OBLIGATORIO EL  
USO DE BOZAL**

O51T

**OBLIGATORIO  
LLEVAR LOS  
PERROS SUJETOS**

O52T

**UTILICEN LA  
PAPELERA**

O54T

**ABROCHARSE  
CINTURÓN  
DE SEGURIDAD**

O39T

**USO  
OBLIGATORIO  
DE LUCES**

O40T

**USO OBLIGATORIO  
DE BATA**

O60T

**NO COLOCARSE  
ENCIMA DE  
LA CARGA**

O61T

**USO OBLIGATORIO  
DE CHALECO  
REFLECTANTE**

O62T

**PASO  
OBLIGATORIO  
DE CARRETILLAS**

O63T

**USO OBLIGATORIO  
DE PROTECTOR  
AUDITIVO**

O64T

**USO OBLIGATORIO  
DE ROPA AJUSTADA**

O65T

**SÓLO  
PERSONAL  
AUTORIZADO**

O66T

**UTILIZAR LAS  
RODILLAS PARA  
LEVANTAR PESO**

O67T

**ARO  
SALVAVIDAS**

O68T

INFORMATIVAS / D'INFORMATION / INFORMATIVE / INFORMATIVO / INFORMATIVOS

Medidas / Measurement / Sizes / Misure / Medidas:  
297 x 210 mm (DIN A-4) Poliestireno / 210x148 mm (DIN A-5) Poliestireno

**PROHIBIDA LA  
ENTRADA A  
MENORES DE  
18 AÑOS**

AC14

**PROHIBIDA LA  
VENTA DE BEBIDAS  
ALCOHÓLICAS A  
MENORES DE 18 AÑOS**

AC15

**PROHIBIDA LA  
VENTA DE TABACO  
A MENORES DE  
18 AÑOS**

AC16

**RESERVADO  
EL DERECHO  
DE ADMISIÓN**

AC17

SOCORRO / SECOURS / SECURITY / SOCCORSO / SOCORRO

LUMINESCENTE / PHOSPHORESCENT / LUMINESCENT / LUMINESCENTE / LUMINESCENTE

Medidas / Measurement / Sizes / Misure / Medidas:

420 x 297 mm (DIN A-3) / 297 x 210 mm (DIN A-4) / 210 x 148 mm (DIN A-5) / 148 x 105 mm (DIN A-6)

UNE-23035-4



EXTINTOR DE INCENDIOS

S001



EXTINTOR DE INCENDIOS

S002



EXTINTOR DE INCENDIOS

S003



EXTINTOR DE INCENDIOS

S004



EXTINTOR USO ELÉCTRICO

S041



EXTINTOR DE CO<sub>2</sub>

S057



CARRO EXTINTOR

S005



CARRO EXTINTOR

S006



CARRO EXTINTOR

S007



CARRO EXTINTOR

S008



MANGUERA

S009



MANGUERA

S010



MANGUERA

S011



MANGUERA

S012



BOCA DE INCENDIO

S042



HIDRANTE

S013



HIDRANTE

S014



HIDRANTE

S015



HIDRANTE

S016



TELÉFONO DE EMERGENCIA

S017



TELÉFONO DE EMERGENCIA

S018



TELÉFONO DE EMERGENCIA

S019



TIMBRE DE ALARMA

S020



TIMBRE DE ALARMA

S021



TIMBRE DE ALARMA

S022



ESCALERA DE INCENDIOS

S023



ESCALERA DE INCENDIOS

S024



ESCALERA DE INCENDIOS

S025



MÁSCARA

S026



MÁSCARA

S036



MÁSCARA

S037



TRAJE IGNÍFUGO

S027



TRAJE IGNÍFUGO

S039



TRAJE IGNÍFUGO

S038



EQUIPO AUTÓNOMO CONTRA INCENDIOS

S034



CAMPANA

S033



EQUIPO Y CONJUNTO DE LUCHA CONTRA INCENDIOS

S050



EQUIPOS CONTRA INCENDIOS

S044



EQUIPOS CONTRA INCENDIOS

S045



CUBO PARA USO EN CASO DE INCENDIO

S047



MANTA IGNÍFUGA

S046



PULSADOR DE ALARMA

S043

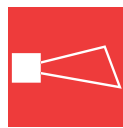

AVISADOR SONORO

S032



PARADA DE EMERGENCIA

S053



LAVAOJOS DE EMERGENCIA

S052

NO HAY SALIDA

S029

NO UTILICEN EN CASO DE EMERGENCIA

S035

NO UTILIZAR EN CASO DE INCENDIO

S028

NO UTILIZAR LOS ASCENSORES EN CASO DE INCENDIO

S048

NO HAY SALIDA NO EXIT

S040

USO EXCLUSIVO SALIDA EMERGENCIA

S051

PUERTAS RESISTENTES AL FUEGO. CERRAR DESPUÉS DE USAR

S049

USO EXCLUSIVO DE BOMBEROS

S054

ROMPASE EN CASO DE EMERGENCIA

S058

UTILIZAR EN CASO DE EMERGENCIA

S059

USO EXCLUSIVO AMBULANCIAS

S060

SOCORRO / SECOURS / SECURITY / SOCCORSO / SOCORRO

LUMINESCENTE / PHOSPHORESCENT / LUMINESCENT / LUMINESCENTE / LUMINESCENTE

Medidas / Measurement / Sizes / Misure / Medidas:

297 x 297 mm / 210 x 210 mm / 148 x 148 mm / 105 x 105 mm

UNE-23035-4



PANORÁMICAS

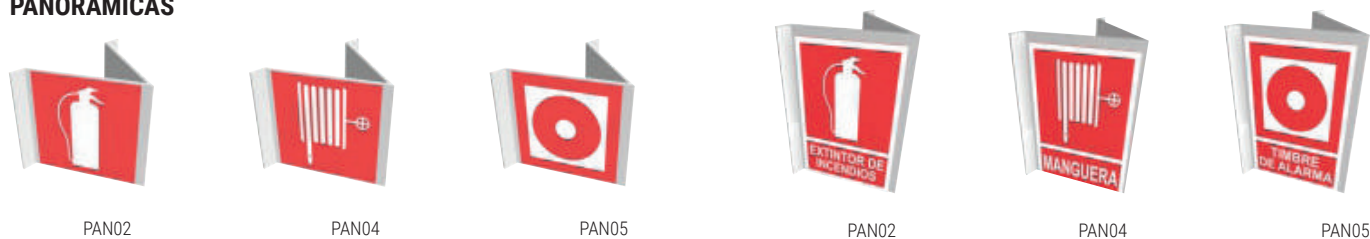

Ref			
PAN02	210 x 210 mm	1	<b>13,65</b>
PAN04	210 x 210 mm	1	<b>13,65</b>
PAN05	210 x 210 mm	1	<b>13,65</b>

Ref			
PAN02	297 x 210 mm	1	<b>13,65</b>
PAN04	297 x 210 mm	1	<b>13,65</b>
PAN05	297 x 210 mm	1	<b>13,65</b>

## ADVERTENCIA / AVERTISSEMENT / WARNING / AVVERTIMENTO / AVISO

Medidas / Measurement / Sizes / Misure / Medidas:

420 x 297 mm (DIN A-3) Poliestireno / 297 x 210 mm (DIN A-4) Poliestireno o adhesivo / 210 x 148 mm (DIN A-5) Poliestireno o adhesivo / 148 x 105 mm (DIN A-6) Poliestireno o adhesivo

**RIESGO  
ELÉCTRICO**

A01

**ALTA TENSIÓN  
PELIGRO  
DE MUERTE**

A110

**PELIGRO!  
ALTA TENSIÓN**

A111

**ATENCIÓN  
PUESTA  
TIERRA**

A02

**PELIGRO  
DE INCENDIO**

A03

**PELIGRO  
GAS  
INFLAMBLE**

A41

**¡ATENCIÓN!  
PROHIBIDO FUMAR, ENCENDER FUEGO  
ACERCAR LLAMAS O APARATOS  
QUE PRODUZCAN CHISPAS**

A45

**¡PELIGRO!  
BOTELLA DE GAS**

A47

**¡PELIGRO!  
MATERIAL  
COMBUSTIBLE**

A04

**¡PELIGRO!  
MATERIAS  
COMBURENTES**

A51

**PELIGRO  
DE EXPLOSIÓN**

A05

**PRECAUCIÓN  
ZONA DE VOLADURAS**

A44

**¡PELIGRO!  
RADIACIONES**

A07

**RADIACIONES  
ULTRAVIOLETAS  
EN SOLDADURA**

A43

**¡PELIGRO!  
RADIACIONES  
LÁSER**

A10

**¡PELIGRO!  
ZONA  
MAGNÉTICA**

A08

**¡PELIGRO!  
CAMPO  
ELECTROMAGNÉTICO**

A38

**¡PELIGRO!  
RADIACIONES  
NO IONIZANTES**

A57

**PELIGRO DE  
INTOXICACIÓN**

A06

**RIESGO  
BIOLÓGICO**

A09

**¡PELIGRO!  
ALTA  
TEMPERATURA**

A11

**¡PELIGRO!  
ALTA  
TEMPERATURA**

A31

**¡PELIGRO!  
CONTACTO  
TÉRMICO**

A32

**¡PELIGRO!  
BAJA  
TEMPERATURA**

A12

**¡ATENCIÓN!  
RIESGO DE  
SALPICADURAS**

A48

**¡PELIGRO!  
CAÍDA  
DE OBJETOS**

A17

**¡PELIGRO!  
ZONA DE CARGA  
Y DESCARGA**

A18

**¡PELIGRO!  
OBJETOS FIJOS  
A BAJA ALTURA**

A16

**¡PELIGRO!  
CARGAS  
SUSPENDIDAS**

A19

**¡PELIGRO!  
DESPRENDIMIENTOS**

A20

**¡PELIGRO!  
ÁREA DE RUIDO  
PELIGROSO**

A14

**¡PELIGRO!  
RIESGO DE  
ATRAPAMIENTO**

A21

**¡PELIGRO!  
RIESGO DE  
ATRAPAMIENTO**

A211

**PELIGRO DE  
ATRAPAMIENTO  
Y PROYECCIÓN  
DE PARTÍCULAS**

A37

**¡PELIGRO!  
PASO DE  
CARRETTILLAS**

A22

**¡PELIGRO!  
SALIDA DE  
CAMIONES**

A23

**¡PELIGRO!  
MAQUINARIA  
PESADA EN  
MOVIMIENTO**

A24

**¡PELIGRO!  
CRUCE DE  
PEATONES**

A33

**ZONA  
DE OBRAS**

A28

**¡PELIGRO!  
SUELO  
RESBALADIZO**

A25

**¡PELIGRO!  
SUELO FRÁGIL**

A251

**¡PELIGRO!  
ANDAMIAJE  
INCOMPLETO**

A39

**¡PELIGRO!  
CAÍDA A  
DISTINTO NIVEL**

A26

**¡PELIGRO!  
CAÍDA AL  
MISMO NIVEL**

A27

**ATENCIÓN  
A PIES  
Y MANOS**

A42

**¡PELIGRO!  
CUCHILLA AFILADA**

A34

**¡PELIGRO!  
CORTES  
DE MANOS**

A35

**¡ATENCIÓN!  
MÁQUINA EN  
REPARACIÓN**

A36



ADVERTENCIA / AVERTISSEMENT / WARNING / AVVERTIMENTO / AVISO

Medidas / Measurement / Sizes / Misure / Medidas:

420 x 297 mm (DIN A-3) Poliéstireno o adhesivo / 297 x 210 mm (DIN A-4) Poliéstireno o adhesivo / 210 x 148 mm (DIN A-5) Poliéstireno o adhesivo / 148 x 105 mm (DIN A-6) Poliéstireno o adhesivo



¡PELIGRO!  
ENCENDIDO  
AUTOMÁTICO

A46



RIESGO DE  
CORROSIÓN

A13



¡ATENCIÓN!  
AIRE COMPRIMIDO

A40



¡PRECAUCIÓN!  
PERROS

A15



PELIGRO  
INDETERMINADO

A29



¡ATENCIÓN!  
CAMPO  
ELECTROSTÁTICO

A50



¡PELIGRO!  
DESPRENDIMIENTO  
DE VIRUTA

A52



¡ATENCIÓN!  
ALTA PRESIÓN

A53



PELIGRO  
POSIBLE ROTURA  
DE SIERRA

A54



MANTENERSE ALEJADO  
DEL SISTEMA  
ARTICULADO DEL CAZO

A56



¡PELIGRO!  
MATERIAS  
NOXIVAS

A30



¡PELIGRO!  
MATERIAS  
IRRITANTES

A49



CALDERA DE GAS  
PROHIBO FUMAR, ENCENDIDOS FUEGOS,  
ACERCAR LLAMAS O APARATOS  
QUE PRODUZCAN CHISPA

A62



FUERA DE  
SERVICIO

A63



¡ATENCIÓN!  
NO UTILICE ESTA MÁQUINA  
SIN ESTAR AUTORIZADO Y  
CONOCER PERFECTAMENTE  
SU FUNCIONAMIENTO

A64



¡ATENCIÓN! PASO  
DE PERSONAS

A65



PELIGRO  
PRODUCTOS  
TÓXICOS

A66



¡PELIGRO!  
RIESGO DE  
TROPEZAR

A67



EX  
ZONA CON RIESGO  
DE ATMÓSFERAS  
EXPLOSIVAS

A61



¡ATENCIÓN!  
PESO LIMITADO  
A

A55



¡ATENCIÓN!  
MATERIAS  
INFLAMABLES

A58



PELIGRO  
RIESGO DE  
APLASTAMIENTO

A68



ESPACIO CONFINADO  
RIESGO  
DE ASFIXIA

A69



ATENCIÓN  
ZANJA ABIERTA

A70



¡ATENCIÓN!  
BATERÍAS  
EN MAL ESTADO

A71



¡PELIGRO!  
ANDAMIO EN  
MAL ESTADO

A72



¡PELIGRO!  
SÓLO MANIPULACIÓN  
MECÁNICA

A73



¡PELIGRO!  
PASO DE TREN

A74



¡PELIGRO!  
SUELO  
IRREGULAR

A75



RIESGO DE  
SOBRESFUERZOS

A76



¡PELIGRO!  
BARRERA

A77



¡PELIGRO!  
MUELLE

A78



¡PELIGRO!  
RAMPA

A79



¡PELIGRO!  
PUENTE  
GRUA MOVIL

A80



¡PELIGRO!  
TRANSITO DE  
VEHICULOS

A81



ALMACÉN DE  
PRODUCTOS  
FITOSANITARIOS

A82



ENTRADA Y  
SALIDA DE  
CAMIONES

A83



¡ATENCIÓN!  
ALARMA  
CONECTADA

A84



PELIGRO DE  
PUNZAMIENTO

A85



¡PELIGRO!  
RIESGO DE  
ATROPELLAO

A86



¡PELIGRO!  
ZONA DE CARGA  
DE BATERÍAS

A87



¡PELIGRO!  
SUPERFICIE CALIENTE

A93



¡PELIGRO!  
PROYECCIÓN  
DE PARTICULAS

A99



CUIDADO CON  
EL ESCALÓN

A88



¡PELIGRO!  
TECHO BAJO

A89



¡ATENCIÓN!  
ZONA SIN  
SOCORRISTA

A94



RIESGO DE  
AHOGAMIENTO

A95



¡PELIGRO!  
ABEJAS

A100



¡PELIGRO!  
ALAMBRE DE ESPINO

A97

ADVERTENCIA / AVERTISSEMENT / WARNING / AVVERTIMENTO / AVISO

Medidas / Measurement / Sizes / Misure / Medidas:

297 x 297 mm - Poliestireno / 210 x 210 mm - Poliestireno o adhesivo / 148 x 148 mm - Poliestireno o adhesivo / 105 x 105 mm - Poliestireno o adhesivo

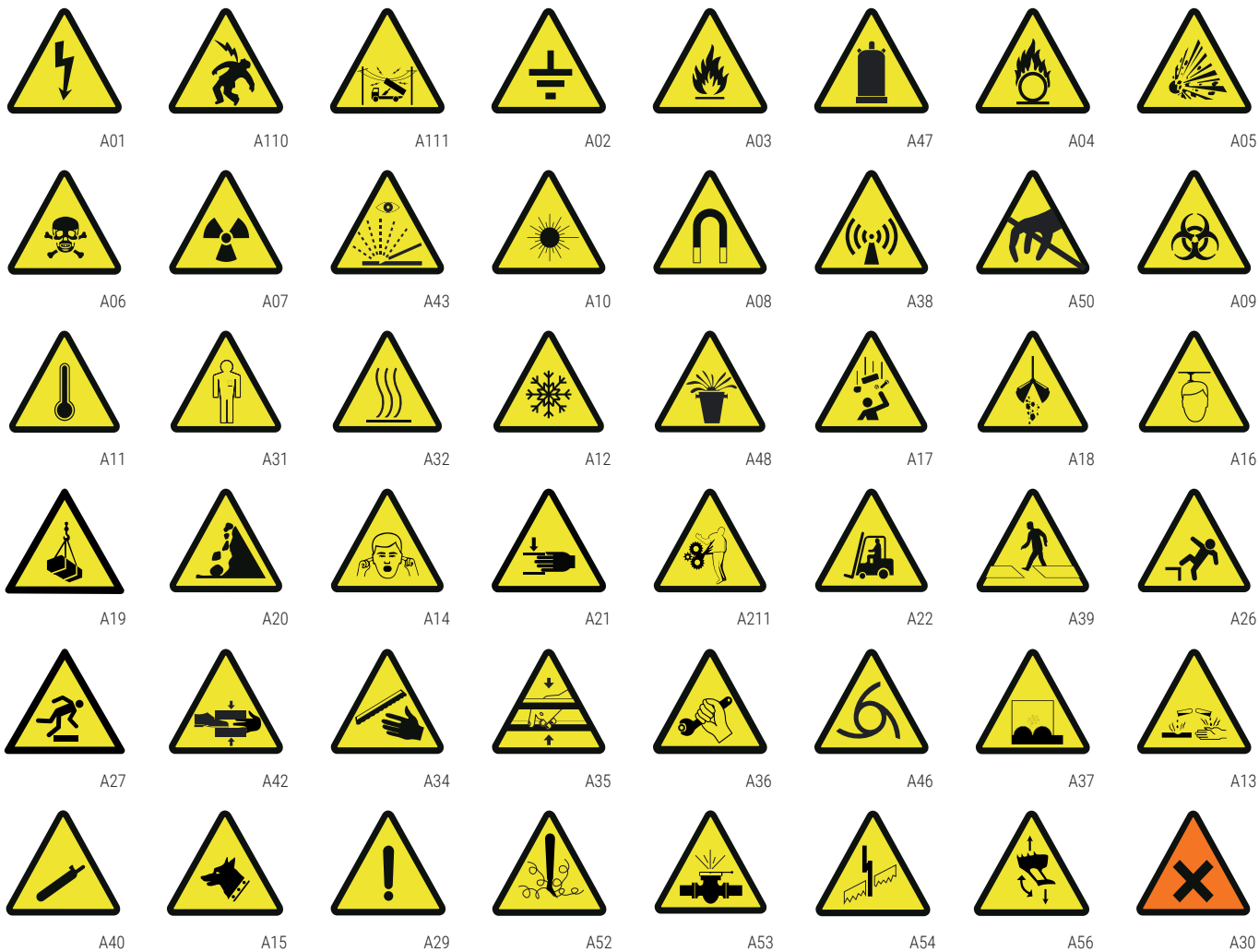

CABALLETE CON TEXTO - SIN TEXTO / CHAVALET AVEC TEXTE - SANS TEXTE / FRAME SIGN WITH TEXT - WITHOUT TEXT  
 CAVALLETTO CON TESTO - SENZA TESTO / SUPORTE COM TEXTO - SEM TEXTO



Personalizable / Customizable

	Ref			
A	2120 1090	620 x 300 mm	1	18,82
B	2120 1091	620 x 300 mm	1	18,62

CONO A 4 CARAS "SUELO RESBALADIZO" / CÔNE 4 FACES "SOL GLISSANT" / SAFETY CONE "WET FLOOR"  
 CONO 4 LATI "PAVIMENTO SCIVOLOSO" / CONE COM 4 LADOS "PISO ESCORREGADIO"



	Ref			
	2120 1102	670 x 280 mm	1	40,78

ADVERTENCIA / AVERTISSEMENT / WARNING / AVVERTIMENTO / AVISO

Medidas / Measurement / Sizes / Misure / Medidas:  
297 x 210 mm (DIN A-4) Poliestireno



A401



A402



A403



A404



A405



A406



A407



A408



A409



A410



A411



A412



A413



A414



A415



A416



A417



A418



A419



A420



A421



A422



A423



A424

Medidas / Measurement / Sizes / Misure / Medidas:  
420 x 297 mm (DIN A-3) Poliestireno / 297 x 210 mm (DIN A-4) Poliestireno



A01T



A110T



A111T



A02T



A03T



A41T



A45T



A47T



A04T



A51T



A05T



A44T



A07T



A43T



A10T



A08T



A38T



A57T



A06T



A09T



A11T



A32T



A12T



A48T

## ADVERTENCIA / AVERTISSEMENT / WARNING / AVVERTIMENTO / AVISO

Medidas / Measurement / Sizes / Misure / Medidas:

420 x 297 mm (DIN A-3) Poliestireno / 297 x 210 mm (DIN A-4) Poliestireno

**¡PELIGRO!  
CAÍDA DE  
OBJETOS**

A17T

**¡PELIGRO!  
ZONA DE CARGA  
Y DESCARGA**

A18T

**¡PELIGRO!  
OBJETOS FIJOS  
A BAJA ALTURA**

A16T

**¡PELIGRO!  
CARGAS  
SUSPENDIDAS**

A19T

**¡PELIGRO!  
DESPRENDIMIENTOS**

A20T

**¡PELIGRO!  
ÁREA DE RUIDO  
PELIGROSO**

A14T

**ZONA  
DE OBRAS**

A28T

**¡PELIGRO!  
SUELO  
RESBALADIZO**

A25T

**PELIGRO  
SUELO FRÁGIL**

A251T

**¡PELIGRO!  
ANDAMIAJE  
INCOMPLETO**

A39T

**¡PELIGRO!  
CAÍDA A  
DISTINTO NIVEL**

A26T

**¡PELIGRO!  
CAIDAS AL  
MISMO NIVEL**

A27T

**ATENCIÓN  
A PIES  
Y MANOS**

A42T

**¡PELIGRO!  
CUCHILLA AFILADA**

A34T

**PELIGRO!  
CORTES  
DE MANOS**

A35T

**¡ATENCIÓN!  
MÁQUINA EN  
REPARACIÓN**

A36T

**PELIGRO  
ENCENDIDO  
AUTOMÁTICO**

A46T

**PELIGRO DE  
ATRAPAMIENTO  
Y PROYECCIÓN  
DE PARTICULAS**

A37T

**RIESGO DE  
CORROSIÓN**

A13T

**¡ATENCIÓN!  
AIRE COMPRIMIDO**

A40T

**¡PRECAUCIÓN!  
PERROS**

A15T

**PELIGRO  
INDETERMINADO**

A29T

**¡ATENCIÓN!  
CAMPO  
ELECTROSTÁTICO**

A50T

**¡ATENCIÓN!  
PERSONAS  
TRABAJANDO**

A60T

**NO ACERCARSE  
AL RADIO DE ACCIÓN  
DE LA MÁQUINA**

A59T

**¡PELIGRO!  
DESPRENDIMIENTO  
DE VIRUTA**

A52T

**¡ATENCIÓN!  
ALTA PRESIÓN**

A53T

**PELIGRO  
POSIBLE ROTURA  
DE SIERRA**

A54T

**MANTENERSE ALEJADO  
DEL SISTEMA  
ARTICULADO DEL CAZO**

A56T

**CALDERA DE GAS  
PROHIBIDO FUMAR, ENCENDER FUEGO,  
ACERCAR LLAMAS O APARATOS  
QUE PRODUZCAN CHISPAS**

A62T

**¡PELIGRO!  
MATERIAS  
NOCIVAS**

A30T

**¡PELIGRO!  
MATERIAS  
IRRITANTES**

A49T

**FUERA DE  
SERVICIO**

A63T

**¡ATENCIÓN!  
NO UTILICE ESTA MÁQUINA  
SIN ESTAR AUTORIZADO Y  
CONOCER PERFECTAMENTE  
SU FUNCIONAMIENTO**

A64T

**ATENCIÓN PASO  
DE PERSONAS**

A65T

**PELIGRO  
PRODUCTOS  
TÓXICOS**

A66T

**¡PELIGRO!  
RIESGO DE  
TROPEZAR**

A67T

**ZONA CON RIESGO  
DE ATMÓSFERAS  
EXPLOSIVAS**

A61T

**¡ATENCIÓN!  
PESO LIMITADO  
A KG**

A55T

COMBINADAS / ASSOCIÉS / COMBINED / COMBINATI / COMBINADAS

Medidas / Measurement / Sizes / Misure / Medidas:  
507 x 210 mm - Poliestireno / 717 x 297 mm - Poliestireno

 PELIGRO DE INCENDIO OBLIGATORIO APAGAR EL CIGARRILLO	 ¡PELIGRO! MATERIAS EXPLOSIVAS OBLIGATORIO APAGAR EL CIGARRILLO	 ¡PELIGRO! EMANACIONES TÓXICAS USO OBLIGATORIO DE EQUIPO AUTÓNOMO	 PELIGRO DE INTOXICACION USO OBLIGATORIO DE MASCARILLA	 ¡PELIGRO! PRODUCTOS TÓXICOS OBLIGATORIO LAVARSE LAS MANOS DESPUÉS DE SU UTILIZACIÓN	 ¡PELIGRO! PRODUCTOS TÓXICOS USO OBLIGATORIO DE EQUIPO DE PROTECCIÓN
CA001	CA002	CA003	CA004	CA005	CA006
 ¡PELIGRO! MATERIAS CORROSIVAS USO OBLIGATORIO DE GUANTES	 ¡PELIGRO! LÍQUIDOS CORROSIVOS USO OBLIGATORIO DE GAFAS ANTISALPICADURA	 MATERIAS NOCIVAS USO OBLIGATORIO DE EQUIPO DE PROTECCIÓN	 MATERIAS IRRITANTES USO OBLIGATORIO DE EQUIPO DE PROTECCIÓN	 ¡PELIGRO! ALTA TENSIÓN USO OBLIGATORIO DE GUANTES AISLANTES	 RIESGO ELÉCTRICO USO OBLIGATORIO DE EQUIPO DE PROTECCIÓN
CA007	CA008	CA009	CA010	CA011	CA012
 ¡ATENCIÓN! CAMPO ELECTROSTÁTICO USO OBLIGATORIO DE ROPA Y MEDIOS ANTISTÁTICOS	 ¡ATENCIÓN! ÁREA DE RUIDO PELIGROSO USO OBLIGATORIO DE PROTECTORES AUDITIVOS	 ZONA RADIACTIVA USO OBLIGATORIO DE ROPA PROTECTORA	 RADIACIONES LÁSER USO OBLIGATORIO DE GAFAS DE PROTECCIÓN	 ¡ATENCIÓN! RIESGO BIOLÓGICO USO OBLIGATORIO DE EQUIPO DE PROTECCIÓN	 BAJA TEMPERATURA USO OBLIGATORIO DE ROPA PROTECTORA
CA013	CA014	CA015	CA016	CA017	CA018
 ALTA TEMPERATURA USO OBLIGATORIO DE ROPA PROTECTORA	 RIESGO DE ATRAPAMIENTO USO OBLIGATORIO DE PROTECTOR FIJO	 ¡PELIGRO! AIRE COMPRIMIDO OBLIGATORIO ENGANCHAR BOTELLAS	 ¡PELIGRO! PROYECCIÓN DE PARTICULAS USO OBLIGATORIO DE PROTECTOR	 ¡PELIGRO! PROYECCIÓN DE PARTICULAS USO OBLIGATORIO DE PANTALLA PROTECTORA	 MATERIAL INCANDESCENTE USO OBLIGATORIO DE EQUIPO DE PROTECCIÓN
CA019	CA020	CA021	CA022	CA023	CA024
 ¡PELIGRO! CAÍDA DE OBJETOS USO OBLIGATORIO DE EQUIPO DE PROTECCIÓN	 ¡PELIGRO! ANDAMIAJE INCOMPLETO USO OBLIGATORIO DE ARNES DE SEGURIDAD	 ¡PELIGRO! CAÍDAS A DISTINTO NIVEL USO OBLIGATORIO DE ARNES DE SEGURIDAD	 ¡PELIGRO! OBRAS USO OBLIGATORIO DE CASCO	 RIESGO DE ATRAPAMIENTO USO OBLIGATORIO DE PROTECTOR AJUSTABLE	 ¡ATENCIÓN! RADIACIONES ULTRAVIOLETA EN SOLDADURA USO OBLIGATORIO DE GAFAS O PANTALLA
CA025	CA026	CA027	CA028	CA029	CA030
 PELIGRO DE INCENDIO PROHIBIDO FUMAR Y ENCENDER FUEGO	 ¡PELIGRO! PRODUCTOS INFLAMABLES PROHIBIDO FUMAR Y ENCENDER FUEGO	 ¡PELIGRO! GAS INFLAMABLE PROHIBIDO FUMAR Y ENCENDER FUEGO	 PELIGRO DE EXPLOSIÓN PROHIBIDO FUMAR Y ENCENDER FUEGO	 ¡PELIGRO! PRODUCTOS EXPLOSIVOS PROHIBIDO FUMAR Y ENCENDER FUEGO	 ¡PELIGRO! ZONA DE VOLADURAS ¡ALTO! NO PASAR
CAP01	CAP02	CAP03	CAP04	CAP05	CAP06
 ¡PELIGRO! MATERIAS TÓXICAS PROHIBIDO EL PASO	 ¡PELIGRO! EMANACIONES TÓXICAS ¡ALTO! NO PASAR	 ÁREA DE TRABAJO CON PLOMO PROHIBIDO COMER Y BEBER	 ¡PELIGRO! MATERIAS CORROSIVAS SÓLO PERSONAL AUTORIZADO	 RIESGO ELÉCTRICO PROHIBIDO ACCIONAR	 ¡PELIGRO! ALTA TENSIÓN PROHIBIDO EL PASO
CA007	CA008	CA009	CA010	CA011	CA012
 ¡ATENCIÓN! HOMBRES TRABAJANDO PROHIBIDO CONECTAR	 ¡ATENCIÓN! CAMPO ELECTROMAGNÉTICO NO ENTRAR CON MARCAPASOS	 ¡ATENCIÓN! ÁREA DE RUIDO PELIGROSO PROHIBIDO EL PASO	 RIESGO DE RADIACIÓN PROHIBIDO EL PASO	 ¡PELIGRO! MATERIAL RADIACTIVO SOLO PERSONAL AUTORIZADO	 RIESGO BIOLÓGICO PROHIBIDO EL PASO
CA013	CA014	CA015	CA016	CA017	CA018
 ¡PELIGRO! CAÍDA DE OBJETOS ¡ALTO! NO PASAR	 ¡PELIGRO! DESPRENDIMIENTOS ¡ALTO! NO PASAR	 ¡PELIGRO! ZONA DE CARGA Y DESCARGA PROHIBIDO EL PASO	 ¡PELIGRO! ANDAMIAJE INCOMPLETO PROHIBIDO EL PASO	 ¡PELIGRO! EXCAVACIONES PROHIBIDO EL PASO	 ¡PELIGRO! SUELO FRÁGIL ¡ALTO! NO PASAR
CA019	CA020	CA021	CA022	CA023	CA024
 ¡PELIGRO! SALIDA DE CAMIONES PROHIBIDO EL PASO	 ¡PELIGRO! PERROS PELIGROSOS PROHIBIDO EL PASO	 ¡PELIGRO! MÁQUINA EN REPARACIÓN PROHIBIDO CONECTAR	 ¡PELIGRO! OBRAS PROHIBIDO EL PASO	 ¡PELIGRO! BAJADA DE MONTACARGAS PROHIBIDO ASOMARSE	
CA025	CA026	CA027	CA028	CA029	



## SEÑALES EN CATALÁN / SIGNAUX EN CATALAN / SIGNALS IN CATALAN / SEGNALÈTICA IN SPAGNOLO / SINAIS EM CATALÃO

Medidas / Measurement / Sizes / Misure / Medidas:  
420 x 297 mm (DIN A-3) Poliestireno / 297 x 210 mm (DIN A-4) Poliestireno

ADVERTENCIA / AVERTISSEMENT / WARNING / AVVERTIMENTO / AVISO

**RISC  
ELECTRIC**

CAT-A01

**PERILL, RISC  
D'INCENDI**

CAT-A03

**PERILLI  
MATERIAL  
COMBUSTIBILE**

CAT-A04

**PERILL  
D'EXPLOSIÒ**

CAT-A05

**PERILLI  
CAIGUDA  
D'OBJECTES**

CAT-A17

**PERILLI  
CÀRREGUES  
SUSPESSES**

CAT-A19

**PERILL,  
RISC  
D'ATRAPAMENT**

CAT-A21

**SORTIDA  
DE  
CAMIONS**

CAT-A23

**MAQUINÀRIA  
PESADA EN  
MOVIMENT**

CAT-A24

**PERILLI  
CAIGUDA A  
DISTINT NIVELL**

CAT-A26

**PERILLI  
CAIGUDA AL  
MATEIX NIVELL**

CAT-A27

**ZONA  
D'OBRES**

CAT-A28

**MATÈRIES  
NOCIVES**

CAT-A30

**PERILL  
PAS DE  
PEATONS**

CAT-A33

**PERILLI  
GAS  
INFLAMBLE**

CAT-A41

**PERILLI  
MATERIAL  
INFLAMBLE**

CAT-A58

**ESPAI CONFINAT  
RISC  
D'ÀSFIXIA**

CAT-A69

## OBLIGACIÓN / OBLIGATION / OBLIGATION / OBBLIGO / OBRIGAÇÃO

**ÚS OBLIGATORI  
DE CASC**

CAT-O01

**ÚS OBLIGATORI  
PROTECTOR  
AUDITIU**

CAT-O02

**ÚS OBLIGATORI  
ULLERES**

CAT-O03

**ÚS OBLIGATORI  
DE GUANTS**

CAT-O09

**ÚS OBLIGATORI  
DE CALÇAT  
DE SEGURETAT**

CAT-O11

**ÚS OBLIGATORI  
DEL CINTURO  
DE SEGURETAT**

CAT-O14

**PAS OBLIGATORI  
PERSONES**

CAT-O25

**DIRECCIO  
OBLIGATORIA  
DRETA**

CAT-O29

**DIRECCIO  
OBLIGATORIA  
ESQUERRA**

CAT-O30

**LLUMS  
OBLIGATORIES**

CAT-O40

**OBLIGATORI  
SUBJECTAR  
AMPOLLES**

CAT-O58

**ÚS OBLIGATORI  
ARMILLA  
REFLECTANT**

CAT-O62

## PROHIBICIÓN / INTERDICTION / PROHIBITION / DIVIETI / PROIBIÇÃO

**PROHIBIT  
EL PAS**

CAT-P01

**PROHIBIT PAS  
PERSONA  
ALIENA OBRA**

CAT-P03

**PROHIBIT  
EL PAS DE  
PEATONS**

CAT-P05

**PROHIBIT PERSONAL  
NO AUTORIZAT**

CAT-P51

**PROHIBIT EL PAS  
A PERSONES  
ALIENES**

CAT-P52

**PROHIBIT  
APARCAR**

CAT-P29

**PROHIBIT ROMANDRE  
SOTA LA CÀRREGA**

CAT-P59

**LLUMS  
OBLIGATORIES**

CAT-P40

**PROHIBIT  
FUMAR**

CAT-P21

**PROHIBIT FUMAR  
PERILL D'INCENDI**

CAT-P22

**PROHIBIT  
ENCENDRE  
FOC**

CAT-P24

**PROHIBIT FUMAR  
I ENCENDRE FOC**

CAT-P45

SEÑALES EN CATALÁN / SIGNAUX EN CATALAN / SIGNALS IN CATALAN / SEGNALETICA IN SPAGNOLO / SINAIS EM CATALÃO

Medidas / Measurement / Sizes / Misure / Medidas:  
420 x 297 mm (DIN A-3) Poliestireno / 297 x 210 mm (DIN A-4) Poliestireno  
LUMINESCENTE / PHOSPHORESCENT / LUMINESCENT / LUMINESCENTE / LUMINESCENTE



Medidas / Measurement / Sizes / Misure / Medidas:  
420 x 297 mm (DIN A-3) Poliestireno  
LUMINESCENTE / PHOSPHORESCENT / LUMINESCENT / LUMINESCENTE / LUMINESCENTE



Medidas / Measurement / Sizes / Misure / Medidas:  
400 x 100 mm Poliestireno  
LUMINESCENTE / PHOSPHORESCENT / LUMINESCENT / LUMINESCENTE / LUMINESCENTE



PANORÁMICAS

Medidas / Measurement / Sizes / Misure / Medidas:  
297 x 210 mm (DIN A-4) Poliestireno



Ref			
CAT-PAN01	297 x 210 mm	1	13,65
CAT-PAN02	297 x 210 mm	1	13,65

INFORMATIVAS / INFORMATION / INFORMATION / INFORMATIVI / INFORMAÇÃO

Glasspack adhesivo / Glasspack adhêsif / Glasspack adhesive / Glasspack adesivo / Glasspack adesivo

Medidas / Measurement / Sizes / Misure / Medidas:

250 x 62 mm / 175 x 45 mm

NO PASAR 101	PROHIBIDO EL PASO 102	PRIVADO 103	PROHIBIDO PERROS 104	PROHIBIDO EL USO DE TELÉFONOS MÓVILES 105	BOTIQUÍN 106
PROHIBIDO HACER FOTOS 107	PROHIBIDO FUMAR 108	ZONA DE FUMADORES 109	ASEOS 110	ASEOS 111	ASEOS 112
ASEOS 113	ASEOS 114	ASEOS 115	ACCESO 116	VESTUARIO 117	VESTUARIO 118
GUARDARROPA 119	TELÉFONO 120	INFORMACIÓN 121	SALIDA 122	ENTRADA 123	PUNTO DE ENCUENTRO 124
TIRAR 125	EMPUJAR 126	POR FAVOR CIERRE LA PUERTA 127	BAR 128	CAFETERÍA 129	COMEDOR 130
OFICINAS 131	DIRECCIÓN 132	ADMINISTRACIÓN 133	ARCHIVO 134	INFORMÁTICA 135	TALLERES 136
CUARTO DE LIMPIEZA 137	DORMITORIO 138	SALA DE ESPERA 139	GUARDERÍA 140	COCINA 141	CAPILLA 142
LABORATORIO 143	APARCAMIENTO 144	ASCENSOR 145	MONTACARGAS 146	ENTREN SIN LLAMAR 147	LLAMAR ANTES DE ENTRAR 148
PROHIBIDO A MENORES 149	PROHIBIDA LA VENTA DE BEBIDAS ALCOHÓLICAS A MENORES DE 18 AÑOS 150	PROHIBIDA LA VENTA DE TABACO A MENORES DE 18 AÑOS 151	EXISTEN HOJAS DE RECLAMACIÓN A DISPOSICIÓN DEL PÚBLICO 152	CAJA 153	VISITAS 154
VENTAS 155	ADMINISTRACIÓN 156	AGUA NO POTABLE 157	DUCHAS 158	GARAJE 159	PARKING 160
ALMACÉN 161	RESERVADO EL DERECHO DE ADMISIÓN 162	GRACIAS POR SU VISITA 163	NO SE ACEPTAN CHEQUES 164	PULL 165	PULL 166
PULL 167	PUSH 168	DON'T ENTER 169	NO SMOKING 170	SMOKING ZONE 171	PULL 172
PUSH 173	EXIT 174	ENTRY 175	OFFICE 176	LIFT 177	TELEPHONE 178
NO WAY OUT 179	DON'T TOUCH 180	RECEPCIÓN 181	TIMBRE 182	SALA DE REUNIONES 183	BIBLIOTECA 184
LAVANDERÍA 185	PROBADOR 186	ZONA WIFI 187	CAMBIADOR DE BEBES 188	SALA DE MAQUINAS 189	SEGURIDAD 190
SALA DE PROFESORES 191	MUSEO 192	AUDIOGUÍA 193	TAQUILLAS 194	SOUVENIRS 195	MIRADOR 196
RECEPCIÓN 197	TEATRO 198	PELUQUERÍA 199	CAJERO 1100	SECRETARÍA 1101	ENTRADAS 1102
AULA 1103	BASURA 1104				



MARCO ABS PROTECTOR

Ref			
2120 1135	250 X 62 mm	1	11,25
2120 1136	175 x 45 mm	1	9,60

SEÑALES INFORMATIVAS VARIAS / PANNEAUX D'INFORMATION DIVERS / INFORMATION SIGNS / SEGNALI INFORMATIVI / VÁRIOS SINAIS DE INFORMAÇÃO



297 x 210 mm	Poliestireno	1	5,70
420 x 297 mm	Poliestireno	1	8,15
500 x 400 mm	Poliestireno	1	12,17
800 x 500 mm	Poliestireno	1	24,04

ACCESORIAS / ACCESSOIRES / ACCESSORIES / ACCESSORI / ACESSÓRIOS

ACCESORIAS / ACCESSOIRES / ACCESSORIES / ACCESSORI / ACESSÓRIOS

Glasspack adhesivo / Glasspack adhésif / Glasspack adhesive / Glasspack adesivo / Glasspack adesivo  
 Medidas / Measurement / Sizes / Misure / Medidas:  
 250 x 62 mm



Glasspack adhesivo / Glasspack adhésif / Glasspack adhesive / Glasspack adesivo / Glasspack adesivo  
 Medidas / Measurement / Sizes / Misure / Medidas: 62 x 62 mm  
 AC + Símbolo / AC + Symbole / AC + Image / AC + Símbolo / AC + Símbolo

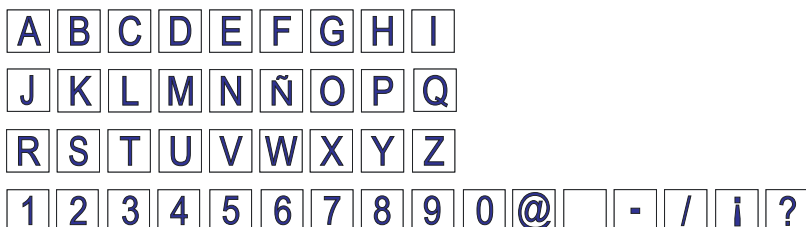

CARTELES PARA OBRAS / AFFICHAGES POUR TRAVAUX / CONSTRUCTION SIGNS / INDICAZIONE PER IL LAVORO / SINAIS DE CONSTRUÇÃO



Ref	GLASSPACK	1000 x 700 mm	1	28,65
2120 1003	0,7 mm	mm		

Ref	GLASSPACK	1000 x 700 mm	1	28,65
2120 1008	0,7 mm	mm		

Ref	GLASSPACK	500 x 700 mm	1	19,25
2120 1002	0,7 mm	mm		

Señales para obras en polipropileno celular. Con anillas para colgar. / Panneaux pour travaux en polypropylène cellulaire. Avec des anneaux pour accrocher sur des clôtures.  
Construction signs made from cellular polypropylene. With rings for hanging up the fence. / Segnali in polipropilene cellulare. Con anelli di sostegno.  
Sinais da construção de polipropileno celular. Com anéis para pendurar.

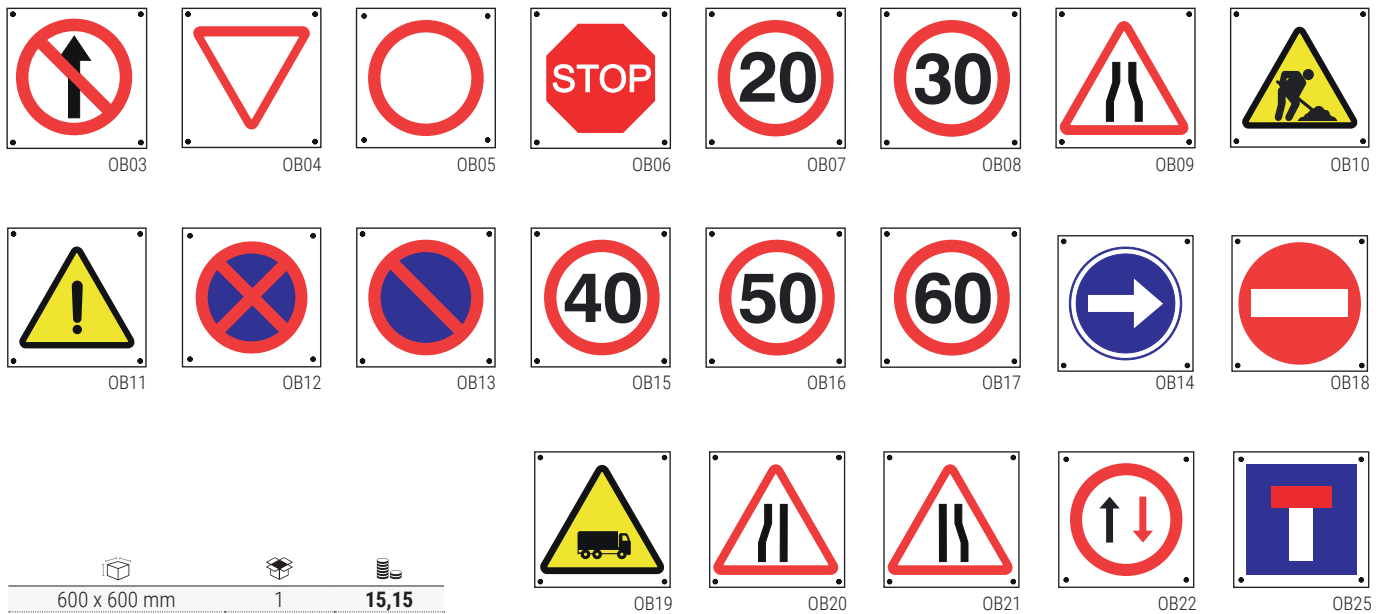

RECICLAJE Y ESPECIALES / RECYCLAGE ET SPÉCIAUX / RECYCLING AND SPECIALS  
RICICLAGGIO E SPECIALI / RECICLAGEM E ESPECIAIS

RECICLAJE Y ESPECIALES / RECYCLAGE ET SPÉCIAUX / RECYCLING AND SPECIALS / RICICLAGGIO E SPECIALI / RECICLAGEM E ESPECIAIS  
Medidas / Measurement / Sizes / Misure / Medidas: 297 x 210 mm (DIN A-4) Poliéstireno y adhesivo

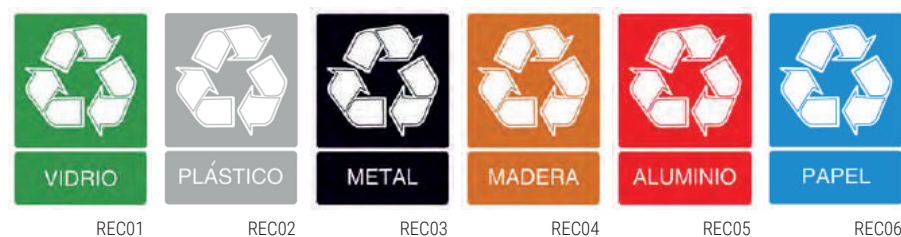

Ref	1	5,93	Ref	1	5,93
2120 1018			2120 1019		



SEÑALIZACIÓN ESPECIAL DE POLIESTIRENO 1,5 mm / BALISAGE POLISTIRÈNE / POLYSTYRENE SIGNPOSTING  
SEGNALLETICA SPECIALE IN POLISTIROLO / SEGNALETICA SPECIALE IN POLISTIROLO

### RESPIRACION DE SALVAMENTO

**BOCA a BOCA**  
**BOCA a NARIZ**

**NO LO TROBESQUE!  
(DOMINEE RAPIDAMENTE)  
¡NO INTERUMPAL RITMO!**

- Examine si hay materias extrañas en la boca de la víctima (monedas, alfileres, arena, tabaco, dentadura suelta, etc.) Si las hay, tuerza la cabeza de la víctima a un lado y quítelas con los dedos envueltos en una tela o en tela.
- Levante el cuello de la víctima y coloque debajo de sus hombros una manita, un abrigo pliegado, etc. Inclínela la cabeza hacia atrás tanto como pueda.
- Agrarre la mandíbula con el pulgar sobre un costado de la boca y tire hacia delante. Conserve esta posición para mantener el paso del aire abierto.
- Cierre la nariz con el pulgar e índice, respire profundamente, coloque su boca sobre la víctima y sople o cierre la boca de la víctima, respire fondo y sople por la nariz. Sopla por la boca o la nariz de la víctima hasta ver que el pecho se infla. A los ritos se les aplica la respiración de salvamento a través de la boca y la nariz, con el pulgar en la boca.
- Retire la boca para que se verifique la salida del aire. A los adultos se les aplica unas 10 respiraciones por minuto. Para los niños unas 20 respiraciones por minuto, aunque si e empuen intubaciones relativamente poco profundas.

Si fracasas los primeros intentos para intar los pulmones, gire a la víctima de lado y administre unos golpes bruscos entre los hombros intentando así eliminar la obstrucción. REPRINTAUBORA EL PROCESO ENTERRAMENTE.

**NOTA:** Un pulso colocado sobre la boca o nariz de la víctima en la necesidad de contacto físico. Esto se aplica gradualmente al paso de 30 a 60. No interrumpir el tratamiento hasta la llegada de un médico.

Requisitos previos a los trabajos en INSTALACIONES ELECTRICAS DE A.T.

# PELIGRO

**NO EMPEZAR NINGUN TRABAJO EN LAS INSTALACIONES DE ALTA TENSION SIN:**

- CORTAR TODAS LAS POSIBLES ALIMENTACIONES DE ALTA Y BAJA TENSION DE LOS ELEMENTOS EN QUE VAYA A TRABAJAR. UTILIZANDO AL ANILLO, CLAVO, BANDERA O AILANTE, O UNANTES AISLANTE Y GAPS PROTECTORES.**
- AL UTILIZAR LAS PERRITAS, LAMPARAS Y PONTALAS A TIERRA SI PROCEDE**
- ELCUCLEAR SI ES POSIBLE LOS APARATOS DE CORTE.**
- COLGAR EN LOS MANOS DE LOS APARATOS DE CORTE LA SEÑAL DE SEGURIDAD CORRESPONDIENTE.**
- COMPROBAR SIEMPRE LA AUMENTA DE TENSION EN LOS ELEMENTOS CONE SE VA A TRABAJAR O EN LOS SITUADOS A DISTANCIA QUE SUPONGAN PELIGRO.**
- COLGAR LAS PONTAS A TIERRA Y EN CONTOURCULO AISLANDO LA ZONA DE TRABAJO.**

**ESTA TOTALMENTE PROHIBIDO PENETRAR EN LAS CELDAS ANTES DE DECLARAR SIN TENSION TODOS LOS APARATOS Y CONDUCTORES CON TENSIOS EN SU INTERIOR (SALVO EL BARRILE GENERAL GUARDO PROCEDE)**

### INSTRUCCIONES DE PRIMEROS AUXILIOS

- PARAR OMPARAR EN ACTIVACION**  
PRIMEROS AUXILIOS: 1. Si el sujeto está inconsciente, abrir la vía aérea de la víctima.  
2. Si el sujeto está consciente, evaluar el nivel de conciencia.
- RECONOCER**  
Asignar los niveles de riesgo de la víctima.
- PARADA CARDIORESPIRATORIA**  
PRIMEROS AUXILIOS: 1. Parada de respiración.  
2. Parada de circulación sanguínea.  
3. Parada de actividad eléctrica del corazón.  
4. Parada de actividad eléctrica del corazón.  
5. Parada de actividad eléctrica del corazón.
- EVALUACION INICIAL**  
VALORACION PRIMARIA: 1. Conciencia.  
2. Respiración.  
3. Circulación sanguínea.  
VALORACION SECUNDARIA: 1. Evaluación detallada de la víctima.  
2. Observación de la escena.
- RENOVIARLAS**  
TRANQUILIZAR a la víctima, hablar con el propósito de que se relaje y respire.  
ALIVAR el dolor de la víctima, controlar de que la víctima no esté recibiendo ningún tipo de lesión por el mecanismo de la lesión.  
EVITAR que el lesionado permanezca en el lugar que no es seguro.  
APLICAR presión con la mano firme y rápida sobre la herida, en un punto limpio, usando un paño limpio o un paño estéril.  
APLICAR la técnica de presión directa sobre la herida, en un punto limpio, usando un paño limpio o un paño estéril.
- AMPUTACIONES**  
Toma de precauciones para evitar la contaminación de la herida y el sangrado al tratarla.
- PRIMEROS AUXILIOS EN CONOCIMIENTO**  
RECONOCER: 1. El accidente ha ocurrido.  
2. El accidente ha ocurrido.  
3. El accidente ha ocurrido.  
4. El accidente ha ocurrido.  
5. El accidente ha ocurrido.  
6. El accidente ha ocurrido.  
7. El accidente ha ocurrido.  
8. El accidente ha ocurrido.  
9. El accidente ha ocurrido.  
10. El accidente ha ocurrido.  
11. El accidente ha ocurrido.  
12. El accidente ha ocurrido.  
13. El accidente ha ocurrido.  
14. El accidente ha ocurrido.  
15. El accidente ha ocurrido.  
16. El accidente ha ocurrido.  
17. El accidente ha ocurrido.  
18. El accidente ha ocurrido.  
19. El accidente ha ocurrido.  
20. El accidente ha ocurrido.  
21. El accidente ha ocurrido.  
22. El accidente ha ocurrido.  
23. El accidente ha ocurrido.  
24. El accidente ha ocurrido.  
25. El accidente ha ocurrido.  
26. El accidente ha ocurrido.  
27. El accidente ha ocurrido.  
28. El accidente ha ocurrido.  
29. El accidente ha ocurrido.  
30. El accidente ha ocurrido.  
31. El accidente ha ocurrido.  
32. El accidente ha ocurrido.  
33. El accidente ha ocurrido.  
34. El accidente ha ocurrido.  
35. El accidente ha ocurrido.  
36. El accidente ha ocurrido.  
37. El accidente ha ocurrido.  
38. El accidente ha ocurrido.  
39. El accidente ha ocurrido.  
40. El accidente ha ocurrido.  
41. El accidente ha ocurrido.  
42. El accidente ha ocurrido.  
43. El accidente ha ocurrido.  
44. El accidente ha ocurrido.  
45. El accidente ha ocurrido.  
46. El accidente ha ocurrido.  
47. El accidente ha ocurrido.  
48. El accidente ha ocurrido.  
49. El accidente ha ocurrido.  
50. El accidente ha ocurrido.  
51. El accidente ha ocurrido.  
52. El accidente ha ocurrido.  
53. El accidente ha ocurrido.  
54. El accidente ha ocurrido.  
55. El accidente ha ocurrido.  
56. El accidente ha ocurrido.  
57. El accidente ha ocurrido.  
58. El accidente ha ocurrido.  
59. El accidente ha ocurrido.  
60. El accidente ha ocurrido.  
61. El accidente ha ocurrido.  
62. El accidente ha ocurrido.  
63. El accidente ha ocurrido.  
64. El accidente ha ocurrido.  
65. El accidente ha ocurrido.  
66. El accidente ha ocurrido.  
67. El accidente ha ocurrido.  
68. El accidente ha ocurrido.  
69. El accidente ha ocurrido.  
70. El accidente ha ocurrido.  
71. El accidente ha ocurrido.  
72. El accidente ha ocurrido.  
73. El accidente ha ocurrido.  
74. El accidente ha ocurrido.  
75. El accidente ha ocurrido.  
76. El accidente ha ocurrido.  
77. El accidente ha ocurrido.  
78. El accidente ha ocurrido.  
79. El accidente ha ocurrido.  
80. El accidente ha ocurrido.  
81. El accidente ha ocurrido.  
82. El accidente ha ocurrido.  
83. El accidente ha ocurrido.  
84. El accidente ha ocurrido.  
85. El accidente ha ocurrido.  
86. El accidente ha ocurrido.  
87. El accidente ha ocurrido.  
88. El accidente ha ocurrido.  
89. El accidente ha ocurrido.  
90. El accidente ha ocurrido.  
91. El accidente ha ocurrido.  
92. El accidente ha ocurrido.  
93. El accidente ha ocurrido.  
94. El accidente ha ocurrido.  
95. El accidente ha ocurrido.  
96. El accidente ha ocurrido.  
97. El accidente ha ocurrido.  
98. El accidente ha ocurrido.  
99. El accidente ha ocurrido.  
100. El accidente ha ocurrido.

Ref				
AMYS01	PO 1,5 mm	420 x 297 mm	1	8,90

Ref				
AMYS02	PO 1,5 mm	420 x 297 mm	1	8,90

Ref				
AMYS03	PO 1,5 mm	420 x 297 mm	1	8,90

SEÑALES INFORMATIVAS VARIAS / PANNEAUX D'INFORMATION DIVERS / INFORMATION SIGNS  
SEGNALLETICA INFORMATIVA VARIA / VÁRIOS SINAIS DE INFORMAÇÃO

## ¡Peligro!

**Está prohibido permanecer en la zona de maniobras de la máquina**

### INSTRUCCIONES DE SEGURIDAD CONTRA INCENDIOS

<b>INCENDIO</b> 1. Mantener la calma. 2. Evitar correr. 3. Evitar gritos. 4. Evitar tocar objetos calientes. 5. Evitar tocar cables eléctricos. 6. Evitar tocar tuberías calientes. 7. Evitar tocar superficies calientes. 8. Evitar tocar superficies calientes. 9. Evitar tocar superficies calientes. 10. Evitar tocar superficies calientes. 11. Evitar tocar superficies calientes. 12. Evitar tocar superficies calientes. 13. Evitar tocar superficies calientes. 14. Evitar tocar superficies calientes. 15. Evitar tocar superficies calientes. 16. Evitar tocar superficies calientes. 17. Evitar tocar superficies calientes. 18. Evitar tocar superficies calientes. 19. Evitar tocar superficies calientes. 20. Evitar tocar superficies calientes. 21. Evitar tocar superficies calientes. 22. Evitar tocar superficies calientes. 23. Evitar tocar superficies calientes. 24. Evitar tocar superficies calientes. 25. Evitar tocar superficies calientes. 26. Evitar tocar superficies calientes. 27. Evitar tocar superficies calientes. 28. Evitar tocar superficies calientes. 29. Evitar tocar superficies calientes. 30. Evitar tocar superficies calientes. 31. Evitar tocar superficies calientes. 32. Evitar tocar superficies calientes. 33. Evitar tocar superficies calientes. 34. Evitar tocar superficies calientes. 35. Evitar tocar superficies calientes. 36. Evitar tocar superficies calientes. 37. Evitar tocar superficies calientes. 38. Evitar tocar superficies calientes. 39. Evitar tocar superficies calientes. 40. Evitar tocar superficies calientes. 41. Evitar tocar superficies calientes. 42. Evitar tocar superficies calientes. 43. Evitar tocar superficies calientes. 44. Evitar tocar superficies calientes. 45. Evitar tocar superficies calientes. 46. Evitar tocar superficies calientes. 47. Evitar tocar superficies calientes. 48. Evitar tocar superficies calientes. 49. Evitar tocar superficies calientes. 50. Evitar tocar superficies calientes. 51. Evitar tocar superficies calientes. 52. Evitar tocar superficies calientes. 53. Evitar tocar superficies calientes. 54. Evitar tocar superficies calientes. 55. Evitar tocar superficies calientes. 56. Evitar tocar superficies calientes. 57. Evitar tocar superficies calientes. 58. Evitar tocar superficies calientes. 59. Evitar tocar superficies calientes. 60. Evitar tocar superficies calientes. 61. Evitar tocar superficies calientes. 62. Evitar tocar superficies calientes. 63. Evitar tocar superficies calientes. 64. Evitar tocar superficies calientes. 65. Evitar tocar superficies calientes. 66. Evitar tocar superficies calientes. 67. Evitar tocar superficies calientes. 68. Evitar tocar superficies calientes. 69. Evitar tocar superficies calientes. 70. Evitar tocar superficies calientes. 71. Evitar tocar superficies calientes. 72. Evitar tocar superficies calientes. 73. Evitar tocar superficies calientes. 74. Evitar tocar superficies calientes. 75. Evitar tocar superficies calientes. 76. Evitar tocar superficies calientes. 77. Evitar tocar superficies calientes. 78. Evitar tocar superficies calientes. 79. Evitar tocar superficies calientes. 80. Evitar tocar superficies calientes. 81. Evitar tocar superficies calientes. 82. Evitar tocar superficies calientes. 83. Evitar tocar superficies calientes. 84. Evitar tocar superficies calientes. 85. Evitar tocar superficies calientes. 86. Evitar tocar superficies calientes. 87. Evitar tocar superficies calientes. 88. Evitar tocar superficies calientes. 89. Evitar tocar superficies calientes. 90. Evitar tocar superficies calientes. 91. Evitar tocar superficies calientes. 92. Evitar tocar superficies calientes. 93. Evitar tocar superficies calientes. 94. Evitar tocar superficies calientes. 95. Evitar tocar superficies calientes. 96. Evitar tocar superficies calientes. 97. Evitar tocar superficies calientes. 98. Evitar tocar superficies calientes. 99. Evitar tocar superficies calientes. 100. Evitar tocar superficies calientes.	<b>PREVENCIÓN DE INCENDIOS</b> 1. Mantener la calma. 2. Evitar correr. 3. Evitar gritos. 4. Evitar tocar objetos calientes. 5. Evitar tocar cables eléctricos. 6. Evitar tocar tuberías calientes. 7. Evitar tocar superficies calientes. 8. Evitar tocar superficies calientes. 9. Evitar tocar superficies calientes. 10. Evitar tocar superficies calientes. 11. Evitar tocar superficies calientes. 12. Evitar tocar superficies calientes. 13. Evitar tocar superficies calientes. 14. Evitar tocar superficies calientes. 15. Evitar tocar superficies calientes. 16. Evitar tocar superficies calientes. 17. Evitar tocar superficies calientes. 18. Evitar tocar superficies calientes. 19. Evitar tocar superficies calientes. 20. Evitar tocar superficies calientes. 21. Evitar tocar superficies calientes. 22. Evitar tocar superficies calientes. 23. Evitar tocar superficies calientes. 24. Evitar tocar superficies calientes. 25. Evitar tocar superficies calientes. 26. Evitar tocar superficies calientes. 27. Evitar tocar superficies calientes. 28. Evitar tocar superficies calientes. 29. Evitar tocar superficies calientes. 30. Evitar tocar superficies calientes. 31. Evitar tocar superficies calientes. 32. Evitar tocar superficies calientes. 33. Evitar tocar superficies calientes. 34. Evitar tocar superficies calientes. 35. Evitar tocar superficies calientes. 36. Evitar tocar superficies calientes. 37. Evitar tocar superficies calientes. 38. Evitar tocar superficies calientes. 39. Evitar tocar superficies calientes. 40. Evitar tocar superficies calientes. 41. Evitar tocar superficies calientes. 42. Evitar tocar superficies calientes. 43. Evitar tocar superficies calientes. 44. Evitar tocar superficies calientes. 45. Evitar tocar superficies calientes. 46. Evitar tocar superficies calientes. 47. Evitar tocar superficies calientes. 48. Evitar tocar superficies calientes. 49. Evitar tocar superficies calientes. 50. Evitar tocar superficies calientes. 51. Evitar tocar superficies calientes. 52. Evitar tocar superficies calientes. 53. Evitar tocar superficies calientes. 54. Evitar tocar superficies calientes. 55. Evitar tocar superficies calientes. 56. Evitar tocar superficies calientes. 57. Evitar tocar superficies calientes. 58. Evitar tocar superficies calientes. 59. Evitar tocar superficies calientes. 60. Evitar tocar superficies calientes. 61. Evitar tocar superficies calientes. 62. Evitar tocar superficies calientes. 63. Evitar tocar superficies calientes. 64. Evitar tocar superficies calientes. 65. Evitar tocar superficies calientes. 66. Evitar tocar superficies calientes. 67. Evitar tocar superficies calientes. 68. Evitar tocar superficies calientes. 69. Evitar tocar superficies calientes. 70. Evitar tocar superficies calientes. 71. Evitar tocar superficies calientes. 72. Evitar tocar superficies calientes. 73. Evitar tocar superficies calientes. 74. Evitar tocar superficies calientes. 75. Evitar tocar superficies calientes. 76. Evitar tocar superficies calientes. 77. Evitar tocar superficies calientes. 78. Evitar tocar superficies calientes. 79. Evitar tocar superficies calientes. 80. Evitar tocar superficies calientes. 81. Evitar tocar superficies calientes. 82. Evitar tocar superficies calientes. 83. Evitar tocar superficies calientes. 84. Evitar tocar superficies calientes. 85. Evitar tocar superficies calientes. 86. Evitar tocar superficies calientes. 87. Evitar tocar superficies calientes. 88. Evitar tocar superficies calientes. 89. Evitar tocar superficies calientes. 90. Evitar tocar superficies calientes. 91. Evitar tocar superficies calientes. 92. Evitar tocar superficies calientes. 93. Evitar tocar superficies calientes. 94. Evitar tocar superficies calientes. 95. Evitar tocar superficies calientes. 96. Evitar tocar superficies calientes. 97. Evitar tocar superficies calientes. 98. Evitar tocar superficies calientes. 99. Evitar tocar superficies calientes. 100. Evitar tocar superficies calientes.	<b>EVACUACION</b> 1. Mantener la calma. 2. Evitar correr. 3. Evitar gritos. 4. Evitar tocar objetos calientes. 5. Evitar tocar cables eléctricos. 6. Evitar tocar tuberías calientes. 7. Evitar tocar superficies calientes. 8. Evitar tocar superficies calientes. 9. Evitar tocar superficies calientes. 10. Evitar tocar superficies calientes. 11. Evitar tocar superficies calientes. 12. Evitar tocar superficies calientes. 13. Evitar tocar superficies calientes. 14. Evitar tocar superficies calientes. 15. Evitar tocar superficies calientes. 16. Evitar tocar superficies calientes. 17. Evitar tocar superficies calientes. 18. Evitar tocar superficies calientes. 19. Evitar tocar superficies calientes. 20. Evitar tocar superficies calientes. 21. Evitar tocar superficies calientes. 22. Evitar tocar superficies calientes. 23. Evitar tocar superficies calientes. 24. Evitar tocar superficies calientes. 25. Evitar tocar superficies calientes. 26. Evitar tocar superficies calientes. 27. Evitar tocar superficies calientes. 28. Evitar tocar superficies calientes. 29. Evitar tocar superficies calientes. 30. Evitar tocar superficies calientes. 31. Evitar tocar superficies calientes. 32. Evitar tocar superficies calientes. 33. Evitar tocar superficies calientes. 34. Evitar tocar superficies calientes. 35. Evitar tocar superficies calientes. 36. Evitar tocar superficies calientes. 37. Evitar tocar superficies calientes. 38. Evitar tocar superficies calientes. 39. Evitar tocar superficies calientes. 40. Evitar tocar superficies calientes. 41. Evitar tocar superficies calientes. 42. Evitar tocar superficies calientes. 43. Evitar tocar superficies calientes. 44. Evitar tocar superficies calientes. 45. Evitar tocar superficies calientes. 46. Evitar tocar superficies calientes. 47. Evitar tocar superficies calientes. 48. Evitar tocar superficies calientes. 49. Evitar tocar superficies calientes. 50. Evitar tocar superficies calientes. 51. Evitar tocar superficies calientes. 52. Evitar tocar superficies calientes. 53. Evitar tocar superficies calientes. 54. Evitar tocar superficies calientes. 55. Evitar tocar superficies calientes. 56. Evitar tocar superficies calientes. 57. Evitar tocar superficies calientes. 58. Evitar tocar superficies calientes. 59. Evitar tocar superficies calientes. 60. Evitar tocar superficies calientes. 61. Evitar tocar superficies calientes. 62. Evitar tocar superficies calientes. 63. Evitar tocar superficies calientes. 64. Evitar tocar superficies calientes. 65. Evitar tocar superficies calientes. 66. Evitar tocar superficies calientes. 67. Evitar tocar superficies calientes. 68. Evitar tocar superficies calientes. 69. Evitar tocar superficies calientes. 70. Evitar tocar superficies calientes. 71. Evitar tocar superficies calientes. 72. Evitar tocar superficies calientes. 73. Evitar tocar superficies calientes. 74. Evitar tocar superficies calientes. 75. Evitar tocar superficies calientes. 76. Evitar tocar superficies calientes. 77. Evitar tocar superficies calientes. 78. Evitar tocar superficies calientes. 79. Evitar tocar superficies calientes. 80. Evitar tocar superficies calientes. 81. Evitar tocar superficies calientes. 82. Evitar tocar superficies calientes. 83. Evitar tocar superficies calientes. 84. Evitar tocar superficies calientes. 85. Evitar tocar superficies calientes. 86. Evitar tocar superficies calientes. 87. Evitar tocar superficies calientes. 88. Evitar tocar superficies calientes. 89. Evitar tocar superficies calientes. 90. Evitar tocar superficies calientes. 91. Evitar tocar superficies calientes. 92. Evitar tocar superficies calientes. 93. Evitar tocar superficies calientes. 94. Evitar tocar superficies calientes. 95. Evitar tocar superficies calientes. 96. Evitar tocar superficies calientes. 97. Evitar tocar superficies calientes. 98. Evitar tocar superficies calientes. 99. Evitar tocar superficies calientes. 100. Evitar tocar superficies calientes.
---------------------------------------------------------------------------------------------------------------------------------------------------------------------------------------------------------------------------------------------------------------------------------------------------------------------------------------------------------------------------------------------------------------------------------------------------------------------------------------------------------------------------------------------------------------------------------------------------------------------------------------------------------------------------------------------------------------------------------------------------------------------------------------------------------------------------------------------------------------------------------------------------------------------------------------------------------------------------------------------------------------------------------------------------------------------------------------------------------------------------------------------------------------------------------------------------------------------------------------------------------------------------------------------------------------------------------------------------------------------------------------------------------------------------------------------------------------------------------------------------------------------------------------------------------------------------------------------------------------------------------------------------------------------------------------------------------------------------------------------------------------------------------------------------------------------------------------------------------------------------------------------------------------------------------------------------------------------------------------------------------------------------------------------------------------------------------------------------------------------------------------------------------------------------------------------------------------------------------------------------------------------------------------------------------------------------------------------------------------------------------------------------------------------------------------------------------------------------------------------------------------------------------------------------------------------------------------------------------------------------------------------------------------------------------------------------------------------------------------------------------------------------------------------------------------------------------------------------------------------------------------------------------------------------------------------------------------------------------------------------------------------------------------------------------------------------------------------------------------------------------------------------------------------------------------------------------------------------------------------------------------------------------------------------------------------------------------------------------------------------------------------------------------------------------------------------------------------------------------------------------------------------------------------------------------------------------------------------------------------------------------------------------------------------------------------------------------------------------------------------------------------------------------------------------------------------------------------------------------------------------------------------------------------------------------------------------------------------------------------------------------------------------------------------------------------------------------------------------------------------------------------------------------------------------------------------------------------------------------------------------------------------------------------------------------------------------------------------------------------------------------------------------------	------------------------------------------------------------------------------------------------------------------------------------------------------------------------------------------------------------------------------------------------------------------------------------------------------------------------------------------------------------------------------------------------------------------------------------------------------------------------------------------------------------------------------------------------------------------------------------------------------------------------------------------------------------------------------------------------------------------------------------------------------------------------------------------------------------------------------------------------------------------------------------------------------------------------------------------------------------------------------------------------------------------------------------------------------------------------------------------------------------------------------------------------------------------------------------------------------------------------------------------------------------------------------------------------------------------------------------------------------------------------------------------------------------------------------------------------------------------------------------------------------------------------------------------------------------------------------------------------------------------------------------------------------------------------------------------------------------------------------------------------------------------------------------------------------------------------------------------------------------------------------------------------------------------------------------------------------------------------------------------------------------------------------------------------------------------------------------------------------------------------------------------------------------------------------------------------------------------------------------------------------------------------------------------------------------------------------------------------------------------------------------------------------------------------------------------------------------------------------------------------------------------------------------------------------------------------------------------------------------------------------------------------------------------------------------------------------------------------------------------------------------------------------------------------------------------------------------------------------------------------------------------------------------------------------------------------------------------------------------------------------------------------------------------------------------------------------------------------------------------------------------------------------------------------------------------------------------------------------------------------------------------------------------------------------------------------------------------------------------------------------------------------------------------------------------------------------------------------------------------------------------------------------------------------------------------------------------------------------------------------------------------------------------------------------------------------------------------------------------------------------------------------------------------------------------------------------------------------------------------------------------------------------------------------------------------------------------------------------------------------------------------------------------------------------------------------------------------------------------------------------------------------------------------------------------------------------------------------------------------------------------------------------------------------------------------------------------------------------------------------------------------------------------------------------	-----------------------------------------------------------------------------------------------------------------------------------------------------------------------------------------------------------------------------------------------------------------------------------------------------------------------------------------------------------------------------------------------------------------------------------------------------------------------------------------------------------------------------------------------------------------------------------------------------------------------------------------------------------------------------------------------------------------------------------------------------------------------------------------------------------------------------------------------------------------------------------------------------------------------------------------------------------------------------------------------------------------------------------------------------------------------------------------------------------------------------------------------------------------------------------------------------------------------------------------------------------------------------------------------------------------------------------------------------------------------------------------------------------------------------------------------------------------------------------------------------------------------------------------------------------------------------------------------------------------------------------------------------------------------------------------------------------------------------------------------------------------------------------------------------------------------------------------------------------------------------------------------------------------------------------------------------------------------------------------------------------------------------------------------------------------------------------------------------------------------------------------------------------------------------------------------------------------------------------------------------------------------------------------------------------------------------------------------------------------------------------------------------------------------------------------------------------------------------------------------------------------------------------------------------------------------------------------------------------------------------------------------------------------------------------------------------------------------------------------------------------------------------------------------------------------------------------------------------------------------------------------------------------------------------------------------------------------------------------------------------------------------------------------------------------------------------------------------------------------------------------------------------------------------------------------------------------------------------------------------------------------------------------------------------------------------------------------------------------------------------------------------------------------------------------------------------------------------------------------------------------------------------------------------------------------------------------------------------------------------------------------------------------------------------------------------------------------------------------------------------------------------------------------------------------------------------------------------------------------------------------------------------------------------------------------------------------------------------------------------------------------------------------------------------------------------------------------------------------------------------------------------------------------------------------------------------------------------------------------------------------------------------------------------------------------------------------------------------------------------------------------------------------------

Ref				
OB 98	Adhesivo / Adhésif Adhesive / Adesivo	150 x 80 mm	1	1,70

Ref				
OB 99	Adhesivo / Adhésif Adhesive / Adesivo	150 x 80 mm	1	1,70

Ref				
AMYS04	Luminiscente Phosphorescent Luminescent Luminiscente Luminiscente	420 x 297 mm	1	8,90

SEÑALIZACIÓN DE VIDEOVIGILANCIA / SIGNALISATION DE VIDÉOSURVEILLANCE / SECURITY VIDEO CAMERA SIGN  
SEGNALAZIONE DI VIDEOSORVEGLIANZA / SINALIZAÇÃO CÂMARA DE VÍDEO

### ZONA VIDEOVIGILADA

**LE INFORMAMOS QUE PUEDE ESTAR SIENDO VIGILADO POR VIDEOCÁMARAS**

**PROTECCIÓN DE DATOS**  
Reglamento (UE) 2016/679 de 27 de abril (GDPR)  
Ley Orgánica (ES) 15/1999 de 13 de diciembre (LOPD)  
Puede ejercer los derechos de acceso, rectificación, suspensión, limitación y oposición ante:

Puede presentar una reclamación ante la autoridad de control en apoyo de Las imágenes se conservarán un máximo de 30 días

### ZONA VIDEOVIGILADA

**PROTECCIÓN DE DATOS**  
Reglamento (UE) 2016/679 de 27 de abril (GDPR)  
Ley Orgánica (ES) 15/1999 de 13 de diciembre (LOPD)  
Puede ejercer los derechos de acceso, rectificación, suspensión, limitación y oposición ante:

Puede presentar una reclamación ante la autoridad de control en apoyo de Las imágenes se conservarán un máximo de 30 días

- ES Señal conforme al reglamento (UE) 2016/679 de protección de datos.
- FR Signal conforme à la réglementation sur la protection des données (UE) 2016/679.
- EN Sign under the regulation (EU) 2016/679 on data privacy.
- IT Segnale conformemente al regolamento (UE) 2016/679 protezione dei dati.
- PT Sinal conforme o regulamento (EU) 2016/679 de proteção de dados.

297 x 210 mm	Poliestireno	1	5,70
210 x 148 mm	Poliestireno	1	3,65
297 x 210 mm	Adhesivo	1	3,50
210 x 148 mm	Adhesivo	1	2,40

VV01

VV02

VINILO SUELO 1000 X 80 MM / VINYLE DE SOL 1000 X 80 MM  
FLOOR MARKING TAPE 1000X80MM / NASTRO ADESIVO IN VINILE 1000X80MM  
VINIL PARA CHÃO 1000X80MM



Ref			
<b>2120 1021</b>	1000 x 80 mm	1	<b>11,65</b>
<b>2120 1021.PT</b>	1000 x 80 mm	1	<b>11,65</b>

CARTEL DIN A-2 SOBRE LAS NORMAS DE HIGIENE  
AFFICHE DIN A-2 SUR LES NORMES D'HYGIÈNE  
DIN A-2 HYGIENE STANDARDS' POSTER  
CARTELLO SULLE NORME D'IGIENE DIN A-2  
PÓSTER DIN A-2 SOBRE NORMAS DE HIGIENE



ES Plancha de PVC.  
FR Planche de PVC.  
EN PVC sheet.  
IT Lastra in PVC.  
PT Prancha de PVC.

Ref			
<b>2120 1022</b>	594 x 420 mm	1	<b>28,30</b>

**ACCESORIOS / ACCESSOIRES / OFFICE / ACCESSORI / ACESSÓRIOS**

MARCO ALUMINIO PARA SEÑAL / TABLEAU ALUMINIUM POUR SIGNAL / ALUMINIUM SINGS FRAME  
STRUTTURA PER SEGNALE IN ALLUMINIO / MOLDURA DE ALUMÍNIO PARA SINAL



Ref			
<b>2120 1116</b>	420 X 297 mm	1	<b>29,48</b>
<b>2120 1117</b>	297 x 210 mm	1	<b>26,21</b>

COLGADOR BLÍSTER ADHESIVO / SUSPENSION BLISTER ADHÉSIF  
ADHESIVE BLISTER HANGER / BLISTER GANCIO ADESIVO  
GANCHO ADESIVO PARA BLISTER



Ref			
<b>2120 1129</b>	50 mm	100	<b>0,33</b>

COLGADOR BLÍSTER ADHESIVO REPARADOR  
SUSPENSION BLISTER ADHÉSIF RÉPARATEUR  
REPAIRER OF ADHESIVE BLISTER HANGER  
BLISTER GANCIO ADESIVO DI RIPARAZIONE  
GANCHO BLISTER ADESIVO REPARAÇÃO



Ref		
<b>2120 1130</b>	100	<b>0,24</b>

CINTAS DE BALIZAMIENTO / RUBALISE / WARNING TAPES / NASTRO DI AVVERTIMENTO / FITAS DE SINALIZAÇÃO



Ref				
1100 0309	80 mm x 200 m	200	1	10,19
1100 0310	50 mm x 100 m	200	1	5,56



Ref				
1100 0305	80 mm x 200 m	200	1	10,50
1100 0311	50 mm x 100 m	200	1	5,80



Ref				
1100 0312	150 mm x 250 m	300	1	31,92



Ref				
1100 0313	150 mm x 250 m	300	1	31,92



Ref				
1100 0314	150 mm x 250 m	300	1	31,92



Ref				
1100 0315	150 mm x 250 m	300	1	72,80



Ref				
1100 0316	80 mm x 100 m	300	1	14,39



Ref				
1100 0317	80 mm x 100 m	300	1	14,39



Ref				
1100 0336	80 mm x 100 m	300	1	14,39



Ref				
1100 0325	80 mm x 200 m	300	1	11,80



Ref				
1100 0326	80 mm x 100 m	300	1	16,77



Ref				
1100 0327	80 mm x 100 m	300	1	16,77



Ref				
1100 0328	80 mm x 100 m	300	1	16,77



Ref				
1100 0330	80 mm x 100 m	300	1	16,77



Ref				
1100 0331	80 mm x 100 m	300	1	16,77



Ref				
1100 0334	80 mm x 100 m	300	1	16,77



Ref				
1100 0335	80 mm x 100 m	300	1	16,77



Ref				
1100 0339	80 mm x 100 m	300	1	16,77

REFLECTANTE



Ref				
1100 0324	100 mm x 100 m	300	1	65,45

**CINTA ADHESIVA PVC / RUBAN ADHÉSIF PVC / PVC ADHESIVE TAPE / NASTRO ADESIVO IN PVC / FITA ADESIVA PVC**

Ref					
1100 0308		amarilla / jaune / yellow / giallo / amarelo	50 mm x 33 m	1	16,22
1100 0318		amarilla-negra / noir-jaune / yellow-black nero-giallo / amarelo-preto	50 mm x 33 m	1	15,44
1100 0319		roja-blanca / rouge-blanc / red-white rosso-bianco / vermelha-branca	50 mm x 33 m	1	15,44

**CINTA ANTIDESLIZANTE / RUBAN ADHÉSIF / NONSLIP TAPE / NASTRO ADESIVO ANTISCIVOLO / FITA ANTIDERRAPANTE**

Ref						
1039 0025	18 m	25 mm	1	24	12,40	
1039 0026	18 m	50 mm	1	12	25,40	

ES Logra un efecto antideslizante, eficaz en áreas que así lo requieran: escaleras, rampas, vehículos, maquinaria, etc. Rollos de 18 metros con anchura de 25 mm y 50 mm.

FR Efficace sur des zones qui ainsi le requièrent : escaliers, rampes, véhicules, maquinaria, etc. Rouleaux de 18 mètres, largeur de 25 mm et 50 mm.

EN Nonslip effect - effective where it is needed: stairs, ramps, cars, machinery, etc. Rolls of 18m, thickness of 25 and 50mm.

IT Ottiene un effetto antiscivolo, efficace in aree che lo richiedono: scale, rampe, veicoli, macchinari, ecc. Rotoli da 18 metri con larghezza da 25mm e 50mm.

PT Tem um efeito anti-derrapante, eficaz em áreas que necessitam: escadas, rampas, veículos, máquinas, etc. Rolos de 18 metros, com largura de 25 mm e 50 mm.



Ref						
1039 0023	18 m	25 mm	1	24	12,40	
1039 0024	18 m	50 mm	1	12	25,40	

**SEÑAL DE MANO CON MANGO ALUMINIO / PANNEAUX A MAIN MANCHE ALUMINIUM / HAND SIGN WITH ALUMINIUM HANDLE**  
**SEGNALÉTICA MANUALE CON MANICO IN ALLUMINIO / SINAL DE MÃO COM CABO EM ALUMÍNIO**

Ref		
2120 1007	1	18,32



PLACAS V-4 DE VELOCIDAD / PLAQUE DE VITESSE V-4 / SPEED V-4 PLATES / PLACCA VELOCITÀ / PLACAS V-4 DE VELOCIDADE

V4



Ref		∅		
199 005	20 km/h	200 mm	1	9,88
199 002	25 km/h	200 mm	1	9,88
199 004	30 km/h	200 mm	1	9,88
199 007	35 km/h	200 mm	1	9,88
199 003	40 km/h	200 mm	1	9,88
199 023	45 km/h	100 mm	1	13,99
199 048	50 km/h	200 mm	1	9,88

PLACA V-5 VEHÍCULOS LENTOS / PLAQUE DE VEHICULES LENTS V-5 / SLOW VEHICLE V-5 PLATE  
 PIASTRA V-5 VEICOLI LENTI / PLACA V-5 VEÍCULOS LENTOS

V5



Ref			
199 006	350 x 365 mm	1	24,34

PLACA V-6 VEHÍCULO LARGO / PLAQUE V-6 VEHICULE LONG / LONG VEHICLE V-6 PLATE / PIASTRA V-6 VEICOLO LUNGO / PLACA V-6 VEÍCULO LONGO

V6



Ref			
199 008	1130 x 200 mm	1	37,34
199 009	565 x 200 mm	1	19,19

PLACAS V-06 PARA REMOLQUES MATERIAL ABS 560 X 140 MM / PLAQUE DE REMORQUES V-06 560 X 140 MM  
 TOW V-06 PLATES 560 X 140 MM / PIASTRA RIMORCHIO V-06 560 X 140 MM / PLACAS V-06 PARA REBOQUES 560 X 140 MM

V06



Ref				
2120 1096	560 x 140 mm	1 PAR	34,84	ABS
199 011	560 x 140 mm	1 PAR	21,32	ALUMINIO



PLACAS HOMOLOGADAS FABRICADAS EN ALUMINIO / PLAQUES HOMOLOGUES EN ALUMINIUM  
AUTHORIZED ALUMINIUM PLATES / PIASTRE OMOLOGATE IN ALLUMINIO / PLACAS APROVADAS FEITAS EM ALUMÍNIO

V9



ES Placa "SP" V-9 Servicio Público.  
FR Plaque SP V-9 Service Public.  
EN "SP" sign V-9 Public Service.  
IT Piastra "SP" V-9 Servizio Pubblico.  
PT Placa "SP" V-9 serviço público.

Ref			
<b>199 014</b>	22,5 x 12 mm	1	<b>8,89</b>
<b>199 015</b>	15,0 x 7,5 mm	1	<b>6,55</b>

PLACAS HOMOLOGADAS FABRICADAS EN ALUMINIO / PLAQUES HOMOLOGUES EN ALUMINIUM  
AUTHORIZED ALUMINIUM PLATES / PIASTRE OMOLOGATE IN ALLUMINIO / PLACAS APROVADAS FEITAS EM ALUMÍNIO

V13



ES Placa conductor novel V-13.  
FR Plaque nouveau conducteur V-13.  
EN Sign Novice drive V-13.  
IT Piastra neopatentati V-13.  
PT Placa Novo Condutor V-13.

Ref			
<b>199 013</b>	150 x 195 mm	1	<b>8,89</b>

PLACA MINUSVÁLIDOS V-15 / PLAQUE HANDICAPÉS V-15 / V-15 DISABLE PLAQUE / SEGNALETICA DISABILI V-15 / SINAL DE MINUSVÁLIDOS V-15

V15



Ref			
<b>199 016</b>	210 x 210 mm	1	<b>11,18</b>

PLACA V-20, "CARGA SOBRESALIENTE" / PLAQUE V-20 DEPASSEMENT LONGUEUR DE CHARGUE / OVERHANGING LOAD, V-20 PLATE  
CARICO SPORGENTE V-20 / PLACA V-20 "CARGA SALIENTE"

V20



Ref			
<b>199 001</b>	500 x 500 mm	1	<b>33,75</b>

PLACA GRÚA DE SERVICIO AUXILIO EN CARRETERA / PLAQUE DÉPANNEUSE SUR ROUTE / TOW AWAY ZONE, NO PARKING SIGN  
PIASTRA CARRO ATTREZZI, SERVIZIO DI ASSISTENZA SU STRADA / SERVIÇO DE ASSISTÊNCIA NA ESTRADA

V24

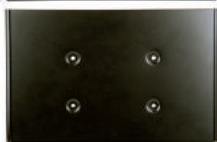

Ref			
<b>199 020</b>	22 x 34 cm	1	<b>20,28</b>

ES Soporte para placa grúa de servicio de auxilio en carretera.

FR Support dépanneuse sur route.

EN Support "tow away zone, no parking sign.

IT Supporto per piastra carro attrezzi, servizio di assistenza su strada.

PT Suporte para placa de serviço de assistência na estrada.

**Soporte / Support**

Ref			
<b>199 021</b>	22 x 34 cm	1	<b>23,02</b>

SEÑALES INFORMATIVAS / PANNEAUX D'INFORMATION / INFORMATION SIGNS / SEGNALI INFORMATIVI / SINAIS INFORMATIVOS



Ref				
199 018	PVC	297 x 210 mm	1	6,14

PLACA MERCANCÍAS PELIGROSAS V-11 / PLAQUES MARCHANDISES DANGEREUSES V-11 / HAZARDOUS MATERIAL PLAQUE V-11  
 SEGNALETICA MERCI PERICOLOSE V-11 / SINAL DE MERCADORIAS PERIGOSAS V-11

V11

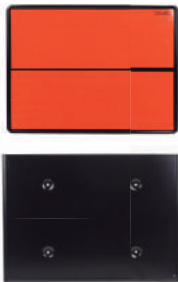

Ref				
2120 1097		40 x 30 cm	1	27,72

Soporte / Support

Ref				
2120 1095		40 x 30 cm	1	19,66

PLACA MERCANCÍAS PELIGROSAS PLEGABLE V-11P / PLAQUES MARCHANDISES DANGEREUSES PLIABLES V-11P  
 HAZARDOUS MATERIAL FOLDABLE PLAQUES / SEGNALETICA PIEGHEVOLE MERCI PERICOLOSE V-11P  
 SINAL DE MATERIAS PERIGOSAS DESDOBRAVEL V-11P

V11P



Ref			
2120 1098		1	29,02

KIT REFLEXIVOS BANDAS OBLICUAS / KIT BANDES RÉFLÉCHISSANTES OBLIQUES / KIT OF REFLECTIVE OBLIQUE STRAPS  
 KIT BANDE OBLIQUE RIFLETTENTI / KIT DE TIRAS OBLÍQUAS REFLEXIVAS

PVC  
 KIT 10 PCS

DISPOSICIÓN:



Superficie mínima  
 delantera  
 0,16 m<sup>2</sup>

Superficie mínima  
 trasera  
 0,32 m<sup>2</sup>

Superficie mínima  
 lateral  
 0,16 m<sup>2</sup>

Ref		PACK		
199 022	145 x 570 mm	10 uds	1 pack	108,16

LUZ GIRATORIA BASE IMÁN (12/24V) / LAMPE ROTATIVE BASE AIMANTEE (12/24V) / REVOLVING LIGHT MAGNET BASE (12/24V)  
 SIRENA LAMPEGGIANTE BASE MAGNETICA (12/24V) / LUZ GIRATÓRIA BASE ÍMÃ (12/24V)

12V / 24V



E8

10R 02 08157



Base Imantada  
 Base Aimantee  
 Magnetic Base  
 Base Magnetica  
 Base Magnética



Ref			
199 041	1	20	32,97

LUZ GIRATORIA BASE IMÁN Y TORNILLO (12/24V) / LAMPE ROTATIVE BASE AIMANTEE AVEC VIS (12/24V)  
 REVOLVING LIGHT MAGNET BASE AND SCREW (12/24V) / SIRENA LAMPEGGIANTE CON BASE MAGNETICA E VITE (12/24V)  
 LUZ GIRATÓRIA BASE ÍMÃ E PARAFUSO (12/24V)

12V / 24V



E8

10R 02 08157

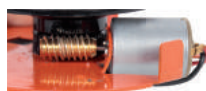

Base Imantada con Tornillo  
 Base Aimantee Avec Vis  
 Magnet Base With Screw  
 Base Magnetica Avvitabile  
 Base Magnética com Parafuso



Ref			
199 042	1	20	35,15

LUZ GIRATORIA PARA SOPORTE (12/24V) / LAMPE ROTATIVE POUR SUPPORT (12/24V) / REVOLVING LIGHT FOR SUPPORT (12/24V)  
 LAMPEGGIANTE COM INNESTO TUBOLARE FLESSIBILE (12/24V) / LUZ GIRATÓRIA DE APOIO (12/24V)

12V / 24V



E8

10R 02 08157



Ref			
199 043	1	20	42,59

LUZ GIRATORIA "LED" BASE IMÁN (12/24V) / GYROPHARE "LED" BASE AIMANT (12/24 V) / LED ROTATING LIGHT MAGNET BASE (12/24 V)  
 SIRENA LAMPEGGIANTE "LED" BASE MAGNETICA (12/24V) / LUZ GIRATORIA "LED" BASE IMAN (12/24 V)

12V / 24V

IP 56  
 60 LED



E13

IOR-04 12764  
 LED SMD

ES 2 posiciones: destellos y giratoria.  
 FR 2 positions intermittent ou en rotation.  
 EN 2 positions: flash and rotary.  
 IT 2 posizioni: lampeggiante e rotante.  
 PT 2 posições: intermitentes e rotativas.

Ref			
199 051	1	20	44,50

LUZ ESTACIONARIA "LED" IMÁN/TORNILLO(12/24V) / LAMPE ROTATIVE COURT BASE AIMANTEE AVEC VIS (12/24V)  
 REVOLVING LIGHT MAGNET BASE AND SCREW(12/24V) / SIRENA LAMPEGGIANTE BASE MAGNETICA E VITE (12/24V)  
 LUZ GIRATÓRIA BASE ÍMÃ E PARAFUSO (12/24V)

12V / 24V  
 IP 56



ECE R65/R10  
 LED



39 LED superbrillantes  
 39 LED superbrillants  
 39 super bright LED lights  
 39 LED super brillanti  
 39 LED super brilhantes

Ref			
199 052	1	20	49,60

LUZ ESTACIONARIA "LED" SOPORTE CORTA (12/24V) / LAMPE ROTATIVE POUR SUPPORT COURT (12/24V)  
 REVOLVING LIGHT SHORT FOR SUPPORT (12/24V) LAMPEGGIANTE COM INNESTO FLESSIBILE (12/24V)  
 LUZ GIRATÓRIA DE APOIO (12/24V)

12V / 24V  
 IP 56



ECE R65/R10  
 LED



39 LED superbrillantes  
 39 LED superbrillants  
 39 super bright LED lights  
 39 LED super brillanti  
 39 LED super brilhantes

Ref			
199 055	1	20	41,50

LUZ ESTACIONARIA "LED" CORTA IMÁN/ TORNILLO (12/24V) / LAMPE ROTATIVE BASE AIMANTEE AVEC VIS (12/24V)  
 REVOLVING LIGHT SHORT MAGNET COURT BASE AND SCREW (12/24V) SIRENA LAMPEGGIANTE CORTA BASE MAGNETICA (12/24V)  
 LUZ GIRATÓRIA CORTA BASE ÍMÃ E PARAFUSO (12/24V)

12V / 24V  
 IP 56



ECE R65/R10  
 LED



39 LED superbrillantes  
 39 LED superbrillants  
 39 super bright LED lights  
 39 LED super brillanti  
 39 LED super brilhantes

Ref			
199 056	1	20	41,50

LUZ ESTACIONARIA "LED" SOPORTE (12/24V) / LAMPE ROTATIVE POUR SUPPORT (12/24V) / REVOLVING LIGHT FOR SUPPORT (12/24V)  
 LAMPEGGIANTE COM INNESTO FLESSIBILE (12/24V) / LUZ GIRATÓRIA DE APOIO (12/24V)

12V / 24V  
 IP56



ECE R65/R10  
 LED



39 LED superbrillantes  
 39 LED superbrillants  
 39 super bright LED lights  
 39 LED super brillanti  
 39 LED super brilhantes

Ref			
199 070	1	20	51,20

LUZ ESTACIONARIA "LED" IMÁN/TORN (12/24V) / LAMPE ROTATIVE BASE AIMANTEE (12/24V) / REVOLVING LIGHT MAGNET BASE (12/24V)  
 SIRENA LAMPEGGIANTE BASE MAGNETICA (12/24V) / LUZ GIRATÓRIA BASE ÍMÃ (12/24V)

12V / 24V  
 IP56



ECE R65/R10  
 LED



39 LED superbrillantes  
 39 LED superbrillants  
 39 super bright LED lights  
 39 LED super brillanti  
 39 LED super brilhantes

Ref			
199 071	1	20	51,20

RECAMBIO LUZ GIRATORIA / PIÈCES DE RECHANGE LAMPE GIRATOIRE / SPARE PART REVOLVING LIGHT  
 RICAMBIO SIRENA LAMPEGGIANTE / LUZ GIRATÓRIA DE SUBSTITUIÇÃO

PARA / FOR  
 199052



Ref		
199 052.01	1	7,28

PARA / FOR 199041



Ref		
199 049	1	7,28

PARA / FOR  
 199042-199052



Ref		
199 040	1	7,28

PARA / FOR 199051



Ref		
199 065	1	8,00

PARA / FOR  
 199042-199043  
 199052



Ref		
199 040A	1	14,56

PARA / FOR  
 199043



Ref		
199 043.01	1	7,28

PARA / FOR  
 199055-199056



Ref		
199 060	1	8,00



SOPORTE LUZ GIRATORIA CON CABLE / SUPPORT LAMPE ROTATIVE AVEC CABLE / SUPPORT FOR REVOLVING LIGHTS WITH CABLE  
 INNESTO TUBOLARE PER LAMPEGGIANTE / SUPORTE PARA LUZ GIRATÓRIA COM CABO



**PARA / FOR**  
**199043-199055-199070**

**1** Pasamuros.  
 Passe Cloisons.  
 Cable Sleeve.  
 Avvitabile.  
 Divisórias.

**2** Atornillable.  
 Vissable.  
 Screw-On Pedestal.  
 Ancoraggio Con Viti A Parte.  
 Aparafusado.

	Ref		
<b>1</b>	<b>199 046</b>	1	<b>15,76</b>
<b>2</b>	<b>199 047</b>	1	<b>15,76</b>

LÁMPARA H1 (LUZ GIRATORIA) / AMPOULE (LAMPE ROTATIVE) / LAMP (REVOLVING LIGHT)  
 LAMPADINA (SIRENA LAMPEGGIANTE) / LÂMPADA (SINALIZADOR)



Ref			
<b>199 044</b>	12V	1	<b>1,98</b>
<b>199 045</b>	24V	1	<b>1,98</b>

LÁMPARA BALIZA SEÑALIZACIÓN CON SENSOR OSCURIDAD / TORCHE DE SIGNALEMENT AVEC CAPTEUR D'OBSCURITE  
 SIGNPOSTING LAMP WITH DARKNESS SENSOR / LAMPADA DI SEGNALEZIONE CON SENSORE DI OSCURITÀ  
 LÂMPADA DE SINALIZAÇÃO COM SENSOR DE ESCURIDÃO



Ref		
<b>1100 0150</b>	1	<b>30,68</b>

BATERÍA 4R25 6V / PILE 4R25 6V / BATTERY 4R25 6V / PILA 4R25 6V / BATERIA 4R25 6V



Ref			
<b>1100 0151</b>	1	6	<b>4,63</b>

TRIÁNGULO DE AVERÍA V-16 / TRIANGLES PANNE V-16 / WARNING TRIANGLE V-16 / TRIANGOLO DI AVARIA V-16 / TRIÂNGULO DE ADVERTÊNCIA V-16



**1 UD**



Ref		
<b>199 012.01</b>	1	<b>5,67</b>

CONOS POLIETILENO CON BASE DE PLÁSTICO DE 30 Y 50 cm / CONES 30 ET 50 cm, BLANCS ET ROUGES / 30 AND 50 cm, WHITE AND RED TRAFFIC CONES  
 CONI DA 30 E 50 cm, COLORE BIANCO E ROSSO / CONES DE SINALIZAÇÃO DE 30 E 50 cm, BRANCOS E VERMELHOS



Ref	👤	⚖️	📦	📊
<b>2120 1004</b>	30 cm	0,55 kg	1	<b>9,35</b>
<b>2120 1005</b>	50 cm	0,635 kg	1	<b>16,39</b>

CONOS POLIETILENO REFLECTANTE CON BASE DE CAUCHO / CONES BLANCS ET ROUGES RÉFLÉCHISSANTS  
 REFLECTIVE WHITE AND RED TRAFFIC CONES / CONI RIFLETTENTI DI COLORE BIANCO E ROSSO / CONES DE SINALIZAÇÃO BRANCOS E VERMELHOS REFLEXIVOS



Ref	👤	⚖️	📦	📊
<b>2120 1011</b>	50 cm	1,5 kg	1	<b>17,42</b>
<b>2120 1012</b>	75 cm	2,5 kg	1	<b>18,20</b>
<b>2120 1013</b>	100 cm	5,0 kg	1	<b>25,33</b>

CONOS PLEGABLES (POSIBILIDAD DE PONER UNA LÁMPARA) / CONES PLIABLES (POSSIBILITE DE METTRE UNE LAMPE)  
 FOLDING TRAFFIC CONES (POSSIBILITY TO PUT ON A LIGHT) / CONI PIEGHEVOLI (POSSIBILITÀ DI APPORRE LAMPEGGIANTI)  
 CONES DE TRÁFICO DOBRÁVEIS (COM POSSIBILIDADE DE POR UMA LÂMPADA)



Ref	👤	⚖️	📦	📊
<b>2120 1014</b>	40 cm	0,54 kg	1	<b>20,70</b>
<b>2120 1015</b>	50 cm	0,56 kg	1	<b>27,92</b>
<b>2120 1016</b>	70 cm	0,96 kg	1	<b>43,11</b>



Lámpara para conos (pilas no incluidas) / Lampe pour cones (pile non comprise) / Light for cones (batteries not included)  
 Lampeggiante per cono (senza pile) / Lâmpada para cones (pilhas não incluidas)

Ref	📦	📊
<b>2120 1017</b>	LR03 AAA x2	<b>6,05</b>

BASTÓN LUMINOSO ROJO / CANNE LUMINEUSE ROUGE / RED BATON LIGHT STICK  
 BASTONE LUMINOSO DI SEGNALAZIONE, ROSSO / VARA LUMINOSA VERMELHA



Ref	↔️	∅	📦	📊
<b>2120 1101</b>	540 mm	40 mm	1	<b>15,75</b>

VALLA EXTENSIBLE RECTA 1100 X 3000 mm / CLÔTURE EXTENSIBLE DROITE 1100 X 3000 mm / STRAIGHT EXTENSIBLE FENCE 1100 X 3000 mm  
BARRIERA ESTENSIBILE DRITTA 1100 X 3000 mm / CERCA EXTENSÍVEL RETA 1100 X 3000 mm



1100 x 250 mm

Medida plegada.  
Dimension replié.  
Folded measurements.  
Misura barriera chiusa.  
Cerca extensível dobrada.

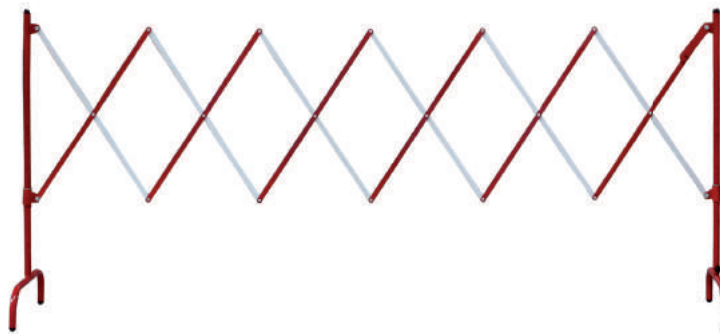

Ref			
2120 1103	1100 x 3000 mm	1	141,50

VALLA EXTENSIBLE CUADRADA 1000 x 1500 mm / CLÔTURE EXTENSIBLE CARREE 1000 x 1500 mm / SQUARE EXTENSIBLE FENCE 1000 x 1500 mm  
BARRIERA ESTENSIBILE QUADRATA 1000 x 1500 mm / CERCA EXTENSÍVEL QUADRADA 1000 x 1500 mm



1100 x 140 X 140 mm

Medida plegada.  
Dimension replié.  
Folded measurements.  
Misura barriera chiusa.  
Cerca extensível dobrada.



Ref			
2120 1104	1000 x 1500 x 1500 mm	1	176,40

POSTE CINTA EXTENSIBLE NEGRA 2100 mm / DEVIDOIR RUBAN EXTENSIBLE NOIR 2100 mm / RECTACTABLE BELT BARRIER 2100 mm  
DIVISORIO NERO A NASTRO ESTENSIBILE 2100 mm / POSTE FITA EXTENSÍVEL PRETA 2100 mm



ES Cierre de seguridad.  
FR Fermeture de sécurité.  
EN Safety lock.  
IT Chiusura di sicurezza.  
PT Fecho de segurança.

Ref	H				
2120 1114	910 mm	2100 mm	320 mm	1	114,66

SOPORTE PARED CINTA EXTENSIBLE NEGRA / SUPPORT MUR RUBAN EXTENSIBLE NOIR / BLACK WALL-MOUNTED RECTACTABLE BELT BARRIER  
NASTRO NERO ESTENSIBILE / SUPORTE PAREDE FITA EXTENSÍVEL PRETA



Ref	H		
2120 1115	130 mm	1	43,26

POSTE Y BASE DE 1 m PARA CADENA / POSTE ET BASE POUR CHAÎNE 1 m / 1 m HIGH PLASTIC CHAIN POST  
BASE E PALO 1 m PER CATENA / POSTE DE PLÁSTICO PARA CORRENTES



Ref				
1100 0803			1	63,90
1100 0804			1	63,90

CADENA DE PLÁSTICO / CHAÎNE EN PLASTIQUE / PLASTIC CHAIN / CATENA IN PLASTICA / CORRENTES DE PLÁSTICO



Ref				
1100 0805			8 mm x 25 m	132,20



Ref				
1100 0806			8 mm x 25 m	132,20

ESLABÓN UNIÓN CADENA PLÁSTICO / LIEN UNION CHAÎNE EN PLASTIQUE / PLASTIC SNAP HOOK FOR CHAIN  
MAGLIA DI UNIONE CATENA IN PLASTICA / MOSQUETÃO DE PLÁSTICO PARA CORRENTE



Ref				
1100 0807			8 mm	1,55
1100 0808			8 mm	1,55

GANCHO "S" CADENA PLÁSTICO / CROCHET "S" CHAÎNE EN PLASTIQUE / PLASTIC "S" HOOK FOR CHAIN  
GANCIO A "S" PER CATENA IN PLASTICA / GANCHO "S" CORRENTE PLÁSTICO



Ref				
1100 0809			8 mm	0,22
1100 0810			8 mm	0,22

ANILLO CONECTOR CADENA PARA CONOS / CONNECTEUR BAGUE CHAÎNE POUR CONES / CONNECTING RING FOR CHAIN POST  
ANELLO DI COLLEGAMENTO CATENA-CONI / ANEL CONECTOR PARA CONES



Ref				
1100 0811			8 mm	2,08
1100 0812			8 mm	2,08

POSTE ABATIBLE PARA PARKING CON CERRADURA 610 mm / POTEAU RABATTABLE POUR PLACE PARKING AVEC SERRURE 610 mm  
FOLDAWAY PARKING POST WITH LOCK 610 mm / PALO PIEGHEVOLE PER PARCHEGGIO CON SERRATURA 610 mm  
POSTE DE ESTACIONAMENTO DOBRÁVEL COM BLOQUEIO 610 mm



Ref	H		
2120 1092	610 mm	1	138,11

BLOQUEO DE PARKING / BLOACAGE POUR PLACE PARKING / FOLDAWAY PARKING POST  
BLOCCO PARCHEGGIO / POSTE DE ESTACIONAMENTO DOBRÁVEL



Ref		
2120 1093	1	163,80

ESQUINERO RECTO DE CAUCHO / PROTEGE COIN LONG / STRAIGHT CORNER BACK / PROTEZIONE ANGOLARE / CANTONEIRA DE PROTEÇÃO



Ref			
1100 0801	800 x 100 x 10 mm	1	19,86

PROTECCIÓN PARKING Y MUELLES DE CARGA DE CAUCHO / PROTECTION PARKING ET QAIS DE CHARGEMENT / PARKING PROTECTION & LOADING BAY  
PARACOLPI DI SICUREZZA, PER PARCHEGGI / PROTEÇÃO EM GARAGENS E REDUTORES DE IMPACTO



Ref			
2120 1094	1000 x 160 x 50 mm	1	42,95



REDUCTOR VELOCIDAD AMARILLO/NEGRO / RÉDUCTEUR DE VITESSE JAUNE/NOIR / YELLOW/BLACK SPEED BUMP  
RALLENTATORI DI VELOCITA' GIALLO/NERO / LOMBA REDUTORA VELOCIDADE AMARELO/PRETO



Ref			
2120 1110	500 x 350 x 50 mm	1	42,98

TERMINACIÓN REDUCTOR VELOCIDAD / ARRÊT RÉDUCTEUR DE VITESSE / SPEED BUMPS END  
PARTE TERMINALE RALLENTATORE DI VELOCITA' / CANTO PARA LOMBA REDUT. VELOCIDADE

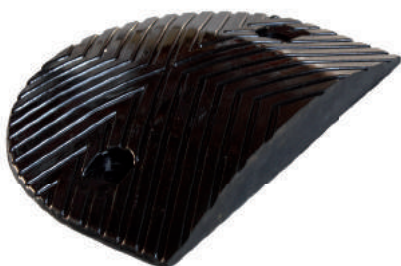

Ref			
2120 1111	250 x 350 x 50 mm	1	21,94

ESQUINA PROTECTOR CABLES / COIN PROTECTEUR CÂBLES / CORNER CABLE PROTECTION RAMP  
PROTEZIONE ANGOLARE CAVI / ESQUINA PROTETORA PARA CABOS

10 Tn



Ref			
2120 1113	310 x 500 x 55 mm	1	76,66

PROTECTOR PARA CABLES (10 tn) / PROTECTEUR DE CÂBLES (10 tn) / CABLE PROTECTION RAMP (10 tn)  
PROTEZIONE CAVI ELETTRICI (10 tn) / PROTEÇÃO PARA CABOS (10 tn)

10 Tn

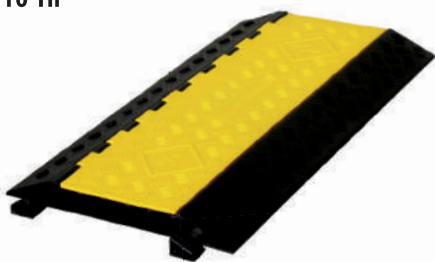

Ref			
2120 1112	900 x 500 x 55 mm	1	205,40

PROTECTOR MANGUERA (40 tn) / PROTECTEUR DE TUYAU (40 tn) / HOSE PROTECTOR (40 tn)  
PROTEZIONE TUBI (40 tn) / PROTEÇÃO PARA MANGUEIRAS (40 tn)

40 Tn



Ref			
2120 1109	900 x 615 x 105 mm	1	310,45

VITRINA MAGNÉTICA CIERRE / VITRINE MAGNÉTIQUE AVEC FERMETURE / MAGNETIC WHITEBOARD CABINET  
BACHECA CHIUSA MAGNETICA / VITRINA MAGNÉTICA C/ FECHO



Ref			
2120 1131	350 x 500 mm	1	111,38
2120 1132	500 x 700 mm	1	150,80

VITRINA CORCHO CIERRE / VITRINE MAGNÉTIQUE AVEC FERMETURE / CORK BOARD CABINET  
BACHECA CHIUSA IN SUGHERO / VITRINA DE CORTIÇA C/ FECHO



Ref			
2120 1133	350 x 500 mm	1	117,62
2120 1134	500 x 700 mm	1	160,52

PIZARRA FONDO DE CORCHO / TABLEAU EN LIÈGE / CORK BOARD / LAVAGNA IN SUGHERO / QUADRO DE CORTIÇA



Ref			
2120 1124	450 x 600 mm	1	22,61
2120 1126	900 x 1200 mm	1	78,48
2120 1127	900 x 1500 mm	1	94,35

SET IMÁN PARA PIZARRA / SET AIMANT PARA TABLEAU / SET WHITEBOARD MAGNETS  
SET CALAMITE PER LAVAGNA MAGNETICA / JOGO ÍMAN PARA QUADRO

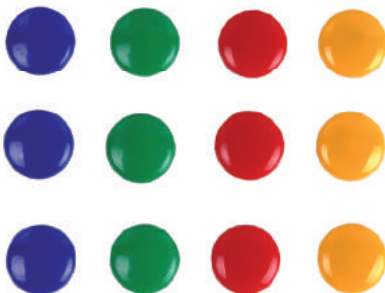

Ref	Ø	PACK		x pack
2120 1121	4 cm	4 pcs	1 pack	5,02
2120 1122	3 cm	6 pcs	1 pack	3,13
2120 1123	2 cm	12 pcs	1 pack	4,92

CAJA DE CHINCHETAS SURTIDAS / BOITE ASSORTIMENT PUNAISES / BOX OF CORK BOARD TACKS  
CONFEZIONE ASSORTITA PUNTINE / PIONÉS - CAIXA SORTIDA



Ref	PACK		x pack
2120 1128	100 pcs	1 pack	2,95

## ESPEJO HEMISFÉRICO / MIROIR HEMISPHERIQUE / HEMISPHERIC MIRROR / SPECCHIO A CUPOLA / ESPELHO HEMISFÉRICO



Ref	Ø		
1100 0472	450 mm	1	121,98
1100 0473	650 mm	1	160,85

ESPEJO MEDIO HEMISFÉRICO / MIROIR DEMI-HEMISPHERIQUE / HEMISPHERIC HALF MIRROR  
SPECCHIO A MEZZA-CUPOLA / ESPELHO SEMI-HEMISFÉRICO

Ref	Ø		
1100 0474	450 mm	1	70,15
1100 0475	650 mm	1	97,01

ESPEJO CUARTO HEMISFÉRICO / MIROIR QUART-HEMISPHERIQUE / HEMISPHERIC QUARTER MIRROR  
SPECCHIO QUARTO DI CUPOLA / ESPELHO QUARTO DE HEMISFÉRICO

Ref	Ø		
1100 0476	450 mm	1	36,60
1100 0477	650 mm	1	42,25

## ESPEJOS REFLECTANTES / MIROIRS REFLECHISSANTS / HIGH VISIBILITY MIRRORS / SPECCHIO RIFLETTENTE / ESPELHOS REFLETORES

**REFLECTANTE  
HIGH VISIBILITY**

Anclaje en mástil.  
Ancrage sur mat.  
Wall and anchorage.  
Ancoraggio a palo.  
Base de fixação para mastro.

Ref	Ø		
1100 0470	600 mm	1	173,12

**REFLECTANTE  
HIGH VISIBILITY**

Anclaje en mástil.  
Ancrage sur mat.  
Wall and anchorage.  
Ancoraggio a palo.  
Base de fixação para mastro.

Ref	Ø		
1100 0471	800 mm	1	289,95

ESPEJO CONVEXO INTERIORES / MIROIR CONVEXE INTERIEURS / INDOOR CONVEX MIRRORS  
SPECCHIO CONVESSO PER INTERNI / ESPELHO CONVEXO INTERIOR



Anclaje de pared  
Ancrage des mur  
Wall anchorage.  
Ancoraggio di parete  
Base de fixação para parede

- ES Espejo convexo adecuado para garajes, supermercados, cruces interiores, colegios, hospitales, etc. Reduce accidentes. Indicado para vigilancia.
- FR Miroir convexe, adapte aux garages, supermarchés, école, hôpitaux, carrefours intérieurs. Pour rester vigilant et réduire les accidents.
- EN Convex mirror provides excellent view on blind corners, inside or outside plants, school, hospitals. Reduce accidents, injuries indicated for vigilance.
- IT Specchio convesso per autorimesse, supermercati, incroci interni, collegi, ospedali, ecc. Riduce gli incidenti, indicato per la vigilanza.
- PT Espelho convexo adequado para garagens, supermercados, cruzamentos, escolas, hospitais, etc. Reduz os acidentes, adequado para vigilância.

Ref	∅		
<b>1100 0184</b>	300 mm	1	<b>65,66</b>
<b>1100 0185</b>	450 mm	1	<b>85,55</b>
<b>1100 0186</b>	600 mm	1	<b>128,34</b>
<b>1100 0187</b>	800 mm	1	<b>244,75</b>

ESPEJO CONVEXO EXTERIORES / MIROIR CONVEXE EXTÉRIEURS / TRAFFIC SAFETY CONVEX MIRRORS  
ESPEJO CONVESSO PER ESTERNI / ESPELHO CONVEXO EXTERIOR



Anclaje en mástil.  
Ancrage sur mat.  
Wall and anchorage.  
Ancoraggio a palo.  
Base de fixação para mastro.







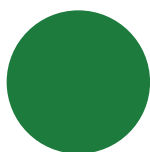







- ES Espejo convexo adecuado para cruces de calles y carreteras, esquinas, etc. Larga duración, resistente a golpes, hecho de una sola pieza, excelente radio de visión.
- FR Miroir convexe adapte aux croisements de la voirie, angles de rue, parkings...longue durée de vie, résiste aux chocs. conception monobloc, excellent rayon de champ visuel.
- EN Lightweight, high impact and scratch resistance mirror one-piece compound backboard and moisture resistance to increase mirror life and durability. provides excellent safety. Good for use on intersections, corners, etc.
- IT Specchio convesso per incroci sulla strada e viali, angoli ciechi, ecc. Lunga durata, resistente a colpi, fatto in un pezzo unico, eccellente raggio di visione.
- PT Espelho convexo adequado para cruzamentos ruas e estradas, cantos, etc. Longa vida, resistente a golpes, feito de uma única peça, excelente alcance de visão.

Ref	∅		
<b>1100 0181</b>	600 mm	1	<b>138,80</b>
<b>1100 0182</b>	800 mm	1	<b>244,75</b>

CÍRCULO ADHESIVO / CERCLE ADHÉSIF / ADHESIVE CIRCLE / BOLLINO ADESIVO / CÍRCULO ADESIVO



Ref		∅		
<b>2120 1105</b>		100 mm	1	<b>1,31</b>
<b>2120 1106</b>		100 mm	1	<b>1,31</b>
<b>2120 1107</b>		150 mm	1	<b>2,62</b>
<b>2120 1108</b>		150 mm	1	<b>2,62</b>

	ES	FR	EN	IT	PT
	Medidas	Mesures	Measurements	Misure	Medidas
	Precio	Prix	Price	Prezzo	Preço
<b>Ref</b>	Referencia	Référence	Reference	Riferimento	Referência
	Packing	Conditionnement	Packing	Imballo	Embalagem
	Longitud	Longueur	Length	Lunghezza	Comprimento
	Material	Matériel	Material	Materiale	Material
	Galga	Galga	Gauge	Spess. µm	Calibrador
	Unidad mínima de venta	Nombre d'unités minimum de vente	Minimum sale unit	Quantitativo minimo di vendita	Unidade mínima de venda
	Descripción	Description	Description	Descrizione	Descrição
	Colores	Couleur	Color	Colore	Cores
	Diámetro	Diamètre	Diameter	Diametro	Diâmetro
	Voltaje	Tension	Voltage	Tensione	Tensão
	Altura	Hauteur	Height	Altezza	Altura
	Peso	Poids	Weight	Peso	Peso
	Pilas	Piles	Batteries	Pile	Pilhas
	Medida de la cadena	Mesure de la chaîne	Chain size	Misura della catena	Medida da cadeia







●.cofan





# ÍNDICE / INDEX / CONTENTS

## INDICE / ÍNDICE



**788**

PULVERIZADORES / PULVERISATEURS / SPRAYERS  
IRRORATORI / PULVERIZADORES



**798**

MALLA ANTIPÁJAROS / FILETS ANTI-OISEAUX  
BIRD NETTING / RETE ANTIUCCELLI  
MALHA ANTI-PÁSSAROS



**791**

MACETAS / POTS DE FLEURS / FLOWER POTS  
VASI PER FIORI / VASOS



**799**

MALLA PLÁSTICA / FILET PLASTIQUE / PLASTIC MESH  
RETE IN PLASTICA / MALHA PLÁSTICO



**793**

CUBOS, CONTENEDORES Y REGADERAS  
CUBE, CONTAINER E ARROSIR  
BUCKET, CONTAINER AND WATERING & VASO  
VASO E INAFFICITOIO  
BALDE, RECIPIENTE E REGADORES

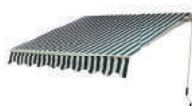

**801**

TOLDOS / STORES / AWNINGS  
TENDE DA SOLE / TOLDOS



**794**

CÉSPED ARTIFICIAL / GAZON ARTIFICIEL  
ARTIFICIAL GRASS / PRATO SINTETICO  
RELVA ARTIFICIAL



**802**

EQUIPAMIENTO PARA JARDÍN  
ACCESSOIRES POUR LE JARDIN  
GARDEN EQUIPMENT  
ATTREZZATURE DA GIARDINO  
EQUIPAMENTO PARA JARDIM



**796**

MALLA SOMBREO  
BRISE VUE MAILLE OCCULTATION / SHADE NETTING  
RETE PROTETTIVA / MALHA OCULTAÇÃO



**808**

PARRILLAS / GRILLE / GRILL  
GRIGLIE / GRELHAS



**809**

BARBACOAS / BARBECUES / BARBECUES  
BARBECUE / BARBECUES



**826**

ASPERSORES / PULVERISATEURS / SPRINKLERS  
IRRIGATORI / ASPERSORES



**813**

TIJERAS RECOLECCIÓN Y JARDINERÍA / CISEAUX  
FRUIT PRUNERS / FORBICI  
TESOURAS DE PODAR E JARDINAGEM



**828**

ACCESORIOS DE RIEGO  
ACCESSOIRES POUR L'ARROSAGE  
WATERING ACCESSORIES  
ACCESSORI PER IRRIGAZIONE  
ACESSÓRIOS DE IRRIGAÇÃO



**821**

RASTRILLOS / RÂTEAUX / RAKES  
RASTRELLI / ANCINHOS



**834**

RIEGO POR GOTEO / ARROSAGE GOUTTE À GOUTTE  
DRIP IRRIGATION / IRRIGATORE A GOCCIA  
IRRIGAÇÃO POR GOTEJAMENTO



**821**

ARTÍCULOS DE TUTORAR / ACCESSOIRES TUTEURS  
SUPPORT ACCESSORIES / ACCESSORI  
ACESSÓRIOS DE SUPORTE



**837**

MÁXIMA SEGURIDAD / SÉCURITÉ MAXIMUM  
MAXIMUM SAFETY / MASSIMA SICUREZZA  
SEGURANÇA MÁXIMA



**822**

MANGUERAS / TUYAU / HOSE  
TUBI / MANGUEIRAS



**840**

GLOSARIO / GLASSAIRE / GLOSSARY  
GLOSSARIO / GLOSSÁRIO



PULVERIZADOR DE ESPALDA 16 L / PULVERISATEUR DORSAL 16 L / BACKPACK SPRAYER 16 L / IRRORATORE SPRAY 16 L / PULVERIZADOR COSTAL 16 L

16L



Ref			
9001 5150	16 L	1	54,70

RECAMBIOS PULVERIZADOR ESPALDA 16 L / PIECES DE RECHANGE - PULVERISATEUR DORSAL / SPARE PARTS - BACKPACK SPRAYER  
RICAMBI - POLVERIZZATORE A PRESSIONE / IRRORATORE A SPALLA PEÇAS DE REPOSIÇÃO - PULVERIZADOR TIPO MOCHILA

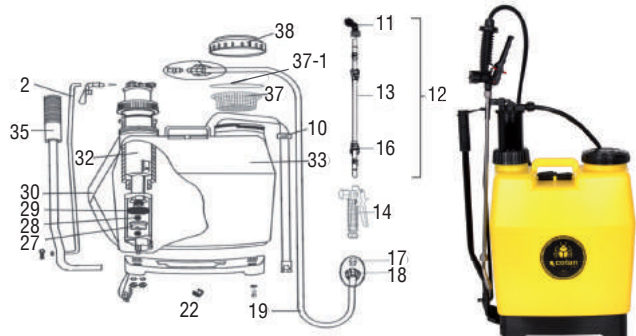

	Ref				Ref		
	9001 515001		2,31		9001 515022		0,78
	9001 515002		3,30		9001 515037		2,32
	9001 515014		7,54		9001 515038		2,35
	9001 515030		7,44		9001 515096		11,74
	9001 515035		5,48		9001 515097		4,40
					9001 515098		12,92
					9001 515099		5,45



PULVERIZADOR PRESIÓN PREVIA 5L / PULVERISATEUR MANUEL A PRESSION / PRESSURE SPRAYER  
IRRORATORE A PRESSIONE / PULVERIZADOR PRESSÃO PRÉVIA

5L



Ref			
9001 5149	5 L	1	33,13

RECAMBIOS PULV. PRESIÓN PREVIA 5L / PIECES DE RECHANGE - PULVERISATEUR MANUEL A PRESSION / SPARE PARTS - PRESSURE SPRAYER  
RICAMBI - POLVERIZZATORE A PRESSIONE / PEÇAS DE REPOSIÇÃO - PULVERIZADOR PRESSÃO PRÉVIA

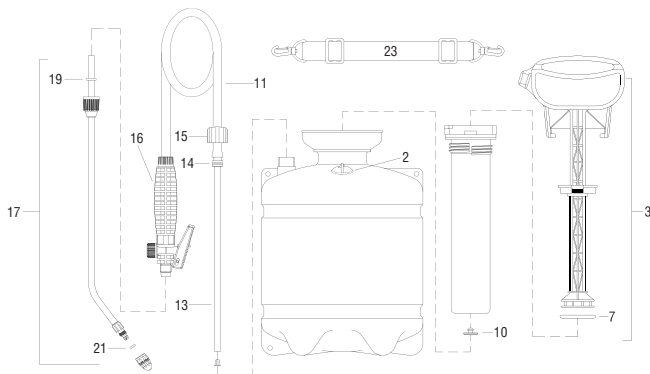

	Ref		
2	9001 514902	Válvula de seguridad (presión) Valve de sécurité (pression) Pressure relief valve assembly Valvola di sicurezza (pressione) Válvula de segurança (pressão)	1,37
3	9001 514903	Bomba presión Pompe Pression Pump assembly Pompante Bomba de pressão	7,55
11	9001 514911	Manguera Flexible Hose assembly Tubo di collegamento flessibile Mangueira	1,46
13	9001 514913	Tubo de la bomba Tube de la pompe Pump's tube Tubo pompa Tubo da bomba	1,25

	Ref		
15	9001 514915	Tuerca de la manguera Vis du tuyau Hose's nut Dado tubo Porca da mangueira	0,27
16	9001 514916	Pistola pulverizador Pistolet pulvérisateur Shut off assembly Pistola irroratore Pistola pulverizador	1,69
17	9001 514917	Lanza pulverizador Lance pulvérisateur Extension assembly Lancia per irrorazione Tubo de pulverização	2,04
23	9001 514923	Correa Courroie Carrying strap Cinghia Correia	2,24
7, 10, 14, 19, 21	9001 514999	Kit juntas tóricas Kit joints Service kit with o-rings Kit O-ring Kit juntas tóricas	4,18



PULVERIZADOR MANUAL / PULVERISATEUR MANUEL / MANUAL SPRAYER / IRRORATORE MANUALE / PULVERIZADOR DE MÃO

500ml



1L



Ref			
9001 5145	500 ml	6	3,07

Ref			
9001 5146	1 L	12	4,04

PULVERIZADOR MANUAL DE PRESIÓN PREVIA / PULVERISATEUR MANUEL A PRESSION / MANUAL PRESSURE SPRAYER / IRRORATORE MANUALE A PRESSIONE / PULVERIZADOR DE MÃO DE PRESSÃO PRÉVIA

1L



2L



Ref			
9001 5140	1 L	1	9,50

Ref			
9001 5141	2 L	1	10,80



MACETAS MODELO ALTEA / POTS DE FLEURS MODÈLE ALTEA / FLOWER POT ALTEA MODEL  
VASI PER FIORI MODELLO ALTEA / VASO MODELO ALTEA

Bricofan



Ref		Ø	↓		
9001 5311	■	11 cm	9,5 cm	1	0,90
9001 5312	■	15 cm	12,6 cm	1	1,55
9001 5313	■	19 cm	16 cm	1	3,02
9001 5314	■	26 cm	22 cm	1	5,81
9001 5315	■	34 cm	29 cm	1	9,45
9001 5317	■	45 cm	43 cm	1	21,65
9001 5318	■	58 cm	51,5 cm	1	31,75
9001 5316	■	70 cm	58 cm	1	70,11
9001 5371	□	15 cm	12,6 cm	1	1,55
9001 5372	□	19 cm	16 cm	1	3,02
9001 5373	□	26 cm	22 cm	1	5,81
9001 5374	□	34 cm	29 cm	1	9,45
9001 5450	□	45 cm	43 cm	1	21,65
9001 5451	□	58 cm	51,5 cm	1	31,75
9001 5375	□	70 cm	58 cm	1	70,11
9001 5376	■	11 cm	9,5 cm	1	0,90
9001 5377	■	15 cm	12,6 cm	1	1,55
9001 5378	■	19 cm	16 cm	1	3,02
9001 5379	■	26 cm	22 cm	1	5,81
9001 5380	■	34 cm	29 cm	1	9,45
9001 5452	■	45 cm	43 cm	1	21,65
9001 5453	■	58 cm	51,5 cm	1	31,75
9001 5381	■	70 cm	58 cm	1	70,11
9001 5382	■	11 cm	9,5 cm	1	0,90
9001 5383	■	15 cm	12,6 cm	1	1,55
9001 5385	■	26 cm	22 cm	1	5,81
9001 5386	■	34 cm	29 cm	1	9,45
9001 5454	■	45 cm	43 cm	1	21,65
9001 5455	■	58 cm	51,5 cm	1	31,75
9001 5387	■	70 cm	58 cm	1	70,11
9001 5388	■	11 cm	9,5 cm	1	0,90
9001 5389	■	15 cm	12,6 cm	1	1,55
9001 5390	■	19 cm	16 cm	1	3,02
9001 5391	■	26 cm	22 cm	1	5,81
9001 5392	■	34 cm	29 cm	1	9,45
9001 5456	■	45 cm	43 cm	1	21,65
9001 5457	■	58 cm	51,5 cm	1	31,75
9001 5393	■	70 cm	58 cm	1	70,11
9001 5394	■	11 cm	9,5 cm	1	0,90
9001 5395	■	15 cm	12,6 cm	1	1,55
9001 5396	■	19 cm	16 cm	1	3,02
9001 5397	■	26 cm	22 cm	1	5,81
9001 5398	■	34 cm	29 cm	1	9,45
9001 5458	■	45 cm	43 cm	1	21,65
9001 5459	■	58 cm	51,5 cm	1	31,75
9001 5399	■	70 cm	58 cm	1	70,11
9001 5364	■	34 cm	29 cm	1	9,25
9001 5365	■	45 cm	43 cm	1	21,65
9001 5366	■	58 cm	51,5 cm	1	31,75
9001 5367	■	70 cm	58 cm	1	52,45
9001 5511	■	11 cm	9,5 cm	1	0,90
9001 5512	■	15 cm	12,6 cm	1	1,55
9001 5513	■	19 cm	16 cm	1	2,53
9001 5514	■	26 cm	22 cm	1	5,06
9001 5515	■	34 cm	29 cm	1	9,25
9001 5516	■	45 cm	43 cm	1	21,65
9001 5517	■	58 cm	51,5 cm	1	31,75
9001 5518	■	70 cm	58 cm	1	52,45

TALLAS GRANDES / BIG SIZES  
Ø58CM / Ø70CM







JARDINERA Y PLATO MODELO "SURFINIA" / JARDINIÈRE ET PLATEAU, MODELE 'SURFINIA' / WINDOW PLANTER AND SAUCER, "SURFINIA" MODEL VASO E SOTTOVASO, MODELLO "SURFINIA" / FLOREIRA E PRATO, MODELO "SURFINIA"

**SURFINIA**



Ref				
9001 5401		40 x 18 x 14 cm	1	3,85
9001 5402		50 x 18 x 15 cm	1	5,05
9001 5403		60 x 18 x 15 cm	1	5,85
9001 5406		40 x 18 x 14 cm	1	3,85
9001 5407		50 x 18 x 15 cm	1	5,05
9001 5408		60 x 18 x 15 cm	1	5,85
9001 5421		40 x 18 x 14 cm	1	3,85
9001 5422		50 x 18 x 15 cm	1	5,05
9001 5423		60 x 18 x 15 cm	1	5,85
9001 5426		40 x 18 x 14 cm	1	3,85
9001 5428		60 x 18 x 15 cm	1	5,85
9001 5431		40 x 18 x 14 cm	1	3,45
9001 5432		50 x 18 x 15 cm	1	4,40
9001 5433		60 x 18 x 15 cm	1	5,25
9001 5441		40 x 18 x 14 cm	1	3,45
9001 5442		50 x 18 x 15 cm	1	4,40
9001 5443		60 x 18 x 15 cm	1	5,25



Ref				
9001 5401S		34 x 12,5 x 3 cm	1	1,60
9001 5402S		45 x 12,5 x 3 cm	1	1,95
9001 5403S		54 x 12 x 3 cm	1	2,20
9001 5406S		34 x 12,5 x 3 cm	1	1,60
9001 5407S		45 x 12,5 x 3 cm	1	1,95
9001 5408S		54 x 12 x 3 cm	1	2,20
9001 5421S		34 x 12,5 x 3 cm	1	1,60
9001 5422S		45 x 12,5 x 3 cm	1	1,95
9001 5423S		54 x 12 x 3 cm	1	2,20
9001 5426S		34 x 12,5 x 3 cm	1	1,60
9001 5428S		54 x 12 x 3 cm	1	2,20
9001 5431S		34 x 12,5 x 3 cm	1	1,60
9001 5432S		45 x 12,5 x 3 cm	1	1,95
9001 5433S		54 x 12 x 3 cm	1	2,20
9001 5441S		34 x 12,5 x 3 cm	1	1,60
9001 5442S		45 x 12,5 x 3 cm	1	1,95
9001 5443S		54 x 12 x 3 cm	1	2,20

COLGADOR JARDINERA "SURFINIA" / SUPPORT JARDINIÈRE 'SURFINIA' / PLANTER HANGER, "SURFINIA" MODEL GANCIO FIORIERA, MODELLO "SURFINIA" / GANCHO P/ FLOREIRA "SURFINIA"

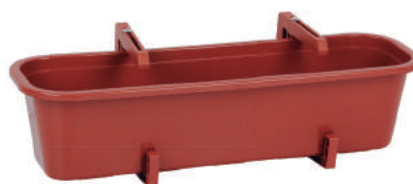

Ref				
9001 5404		Talpa / Taupe / Talpa / Talpa / Talpa	23 x 21 cm	1 1,77
9001 5409		Antracita / Anthracite / Anthracite / Antracite / Antracite	23 x 21 cm	1 1,77
9001 5424		Lima / Citron vert / Lime / Lime / Lima	23 x 21 cm	1 1,77
9001 5429		Blanco / Blanc / White / Bianco / Branco	23 x 21 cm	1 1,77
9001 5435		Terracota/Terracotta/Terracotta/Terracotta/Terracota	23 x 21 cm	1 1,58
9001 5445		Forest-Verde/Vert-Foret/ Forest-Green/Verde Foresta/Forest-Verde	23 x 21 cm	1 1,58





ABONO AZUL PLANTAS Y FLORES / ENGRAIS BLEU / BLUE FERTILISER / SODA CAUSTICA COFAN / SODA CÁUSTICA



ES Fertilizante de flores y plantas. Indicado para fertilizar maíz, árboles frutales y ornamentales, arbustos, jardines, flores, plantas, entre otros. Abono compuesto por NPK azul especial a base de Sulfato de Potasio con Magnesio. Contiene Superfosfato CAS: 8011-76-5.

FR Engrais fleurs et plantes. Indiqué pour fertiliser maïs, arbres fruitiers et d'ornement, arbustes, jardins, fleurs, plantes, entre autres. Engrais composé de NPK bleu spécial sur base de Sulfate de Potassium avec Magnésium. Contient du Superphosphate CAS : 8011-76-5.

EN Plant and flower fertiliser. Suitable for fertilising corn, ornamental and fruit trees, bushes, gardens, flowers, plants, etc. This fertiliser is made up of special blue NPK made of Potassium Sulphate with Magnesium. Contains Superphosphate CAS: 8011-76-5.

IT Fertilizzante per fiori e piante. Indicato per fertilizzare mais, alberi da frutta e piante ornamentali, arbusti, giardini, fiori e molto altro. Con compost speciale NPK blu, a base di Solfato di Potassio con Magnesio. Contiene superfosfato CAS: 8011-76-5.

PT Fertilizantes de flores e plantas. Indicado para fertilizar milho, árvores de frutas e árvores ornamentais, arbustos, jardins, flores, plantas, entre outros. Adubo composto por NPK azul especial à base de Sulfato de potássio com magnésio. Contém Superfosfato CAS: 8011-76-5.

Ref				
1580 1071	1 kg	1	6	8,09

CUBOS, CONTENEDORES Y REGADERAS / CUBE, CONTAINER E ARROSIR  
BUCKET, CONTAINER AND WATERING & VASO / VASO E INAFFICITOIO / BALDE, RECIPIENTE E REGADORES

CUBO JARDINERÍA CON VERTEDOR / JARDINIÈRE CUBE AVEC DRAIN / GARDEN BUCKET WITH FUNNEL  
VASO GIARDINAGGIO CON SOTTOVASO / BALDE DE JARDINAGEM COM BICO



Ref			B	C	Ø			
9001 5211		12 L	23,6 cm	24,5 cm	31,4 cm	1	10	6,19
9001 5212		20 L	26,5 cm	28,5 cm	36,5 cm	1	10	10,09

BARREÑO CONTENEDOR JARDÍN / CONTAINER JARDIN / GARDEN CONTAINER / VASO GIARDINAGGIO / ALGUIDAR RECIPIENTE DE JARDIM



Ref			B	Ø			
9001 5213		40 L	28,8 cm	50,8 cm	1	10	18,10
9001 5214		65 L	33,6 cm	59,4 cm	1	10	21,63

REGADERAS VERDES-AZULES / ARROSOIR COULEUR VERTE-BLEUE / WATERING CAN GREEN-BLUE  
INNAFFIATOIO COLORE VERDE-BLU / REGADORES CORES VERDE-AZUL



Ref			A	B	C			
9001 5227		2.5 L	11,8 cm	22,3 cm	39,0 cm	1	10	6,14
9001 5225		5 L	15,0 cm	27,6 cm	48,0 cm	1	10	9,20
9001 5226		10 L	18,0 cm	33,4 cm	55,0 cm	1	10	9,98



CONTENEDOR 2 RUEDAS (120 LITROS) / POUBELLE 2 ROUES (120 LITRES) / 2 WHEELS CONTAINER (120 LITER)  
CONTENITORE A 2 RUOTE (120 LITRI) / CONTENTOR 2 RODAS (120 LITROS)



Ref	A	B	C					
2120 1501	927 mm	480 mm	543 mm		Verde / Vert / Green / Verde / Verde	120 L	1	131,41
2120 1502	927 mm	480 mm	543 mm		Azul / Bleu / Blue / Blu / Azul	120 L	1	131,41
2120 1503	927 mm	480 mm	543 mm		Amarillo / Jaune / Yellow / Giallo / Amarelo	120 L	1	131,41

PEDAL CON ARO SUJETA BOLSA CONTENEDOR (120 LITROS) / PÉDALE AVEC CERCLAGE DE SUPPORT POUR POUBELLE (120 LITRES)  
PEDAL WITH BAG SUPPORT RING, CONTAINER (120 LITRES) / PEDALE CON CERCHIONE PER PATTUMIERA (120 LITRI)  
PEDAL COM ARO P/ PRENDER SACO, RECIPIENTE (120 LITROS)

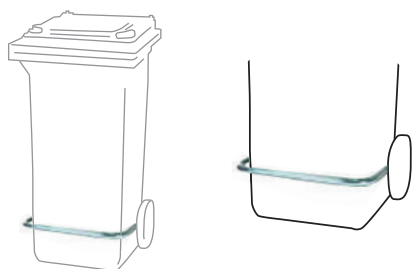

Ref			
2120 1599	120 L	1	81,90

CONTENEDOR 2 RUEDAS, COLOR VERDE / POUBELLE 2 ROUES, COULEUR VERTE / 2 WHEELS CONTAINER, GREEN  
CONTENITORE A 2 RUOTE, COLORE VERDE / CONTENTOR 2 RODAS, COR VERDE



**240 L / 360 L**

Ref	A	B	C			
2120 1521	1062 mm	577 mm	715 mm	240 L	1	192,35
2120 1531	1098 mm	601 mm	880 mm	360 L	1	309,02

**CÉSPED ARTIFICIAL / GAZON ARTIFICIEL / ARTIFICIAL GRASS  
PRATO SINTETICO / RELVA ARTIFICIAL**

CÉSPED ARTIFICIAL / GAZON ARTIFICIEL / ARTIFICIAL GRASS / PRATO SINTETICO / RELVA ARTIFICIAL

**SGS RoHS**



Ocio / Deporte  
Loisir/Sport  
Sports / Leisure  
Tempo Ilbero / Sport  
Lazer / Desporto



No tóxico  
Non toxique  
Nontoxic  
Atossico  
Não-tóxico



Fácil Limpieza  
Nettoyage facile  
Easy cleaning  
Di facile pulizia  
Limpeza fácil

Polietileno / 100% Reciclabl  
Polyethylene / 100% Recyclabl  
Polyethylene / 100% reciclabl  
Polietileno / 100% Riciclabl  
Polietileno / 100% Reciclabl

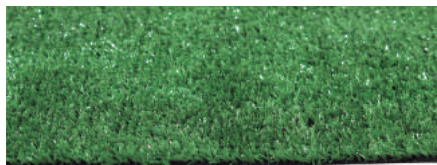

ES Césped artificial tipo moqueta en color verde ejército fabricado en fibrilado de polipropileno y soporte en látex y polipropileno.  
FR Gazon synthétique type moquette en couleur verte armée fabriqué en fibre polypropylène et support en latex et polypropylène.  
EN Army-green artificial grass, fitted carpet type. Made from fibrillated Polypropylene with Latex and polypropylene support.  
IT Erba sintetica tipo moquette, colore verde esercito. Fabricata in Polipropilene fibrillato e con supporto in Lattice e Polipropilene.  
PT Relva artificial, tipo tapete, em verde exército, feita de fibrila de Polipropileno e suporte em látex e polipropileno.

Ref		DTEX	PUNTADAS	↑			
9001 6500	1 x 5 m	2200	65520 ± 100	7 ± 1 mm	1029 g/m <sup>2</sup> ± 10%	1	43,52
9001 6501	2 x 5 m	2200	65520 ± 100	7 ± 1 mm	1029 g/m <sup>2</sup> ± 10%	1	87,05
9001 6502	2 x 25 m	2200	65520 ± 100	7 ± 1 mm	1029 g/m <sup>2</sup> ± 10%	1	435,24



CÉSPED ARTIFICIAL / GAZON ARTIFICIEL / ARTIFICIAL GRASS / PRATO SINTETICO / RELVA ARTIFICIAL

SGS RoHS



Ocio / Deporte  
Loisir/Sport  
Sports / Leisure  
Tempo libero / Sport  
Lazer / Desporto

Residencial  
Residencial  
Residencial  
Residencial



No tóxico  
Non toxique  
Nontoxic  
Atossico  
NÃO-tóxico

Tratamiento Anti-UV  
Traitement anti-UV  
Anti-UV treatment  
Tratamento anti-UV  
Tratamento anti-UV



Fácil Limpieza  
Nettoyage facile  
Easy cleaning  
Di facile pulizia  
Limpeza fácil

Poliétileno / 100% Reciclabl  
Polyethylene / 100% Recyclabl  
Poliétileno / 100% Reciclabl  
Poliétileno / 100% Reciclav



ES Césped artificial bicolor verde esmeralda y oliva oscuro, fabricado en monofilamento de polietileno de fibra rizada y polipropileno con soporte en látex y polipropileno de fibra corta.

FR Gazon synthétique bicolore vert émeraude et Olive foncé fabriqué en monofilament de Polyéthylène de fibre bouclée et Polypropylène avec support en latex et polypropylène de fibre courte.

EN Two-coloured artificial grass composed of emerald and dark olive green. Made from polyethylene monofilament, curly fibre and polypropylene with latex support and short-fibre polypropylene.

IT Erba sintetica bicolore verde smeraldo e Oliva scuro. Fabbriato con Monofilamenti in Polietilene arricciato e Polipropilene con supporto in Lattice e Polipropilene a fibra corta.

PT Relva artificial, bicolor em verde esmeralda e azeitona escuro, fabricado em monifilo de polietileno de fibra crespa e polipropileno com suporte em Látex e polipropileno de fibra curta.

Ref		DTEX 1	DTEX 2			PUNTADAS		
9001 6530	1 x 4 m	45000	3300	80,90 ± 100	0,4 ± 0,8 mm	16800 g/m <sup>2</sup> ± 10%	1	<b>84,14</b>
9001 6531	2 x 4 m	45000	3300	161,70 ± 100	0,4 ± 0,8 mm	16800 g/m <sup>2</sup> ± 10%	1	<b>168,17</b>
9001 6532	2 x 10 m	45000	3300	385,95 ± 100	0,4 ± 0,8 mm	16800 g/m <sup>2</sup> ± 10%	1	<b>401,39</b>

SGS RoHS



Ocio / Deporte  
Loisir/Sport  
Sports / Leisure  
Tempo libero / Sport  
Lazer / Desporto

Residencial  
Residencial  
Residencial  
Residencial



No tóxico  
Non toxique  
Nontoxic  
Atossico  
NÃO-tóxico

Tratamiento Anti-UV  
Traitement anti-UV  
Anti-UV treatment  
Tratamento anti-UV  
Tratamento anti-UV



Fácil Limpieza  
Nettoyage facile  
Easy cleaning  
Di facile pulizia  
Limpeza fácil

Poliétileno / 100% Reciclabl  
Polyethylene / 100% Recyclabl  
Poliétileno / 100% Reciclabl  
Poliétileno / 100% Reciclav



ES Césped artificial bicolor verde esmeralda y oliva oscuro, fabricado en monofilamento de polietileno de fibra rizada y polipropileno con soporte en látex y polipropileno de fibra corta.

FR Gazon synthétique bicolore vert émeraude et Olive foncé fabriqué en monofilament de Polyéthylène de fibre bouclée et Polypropylène avec support en latex et polypropylène de fibre courte.

EN Two-coloured artificial grass composed of emerald and dark olive green. Made from polyethylene monofilament, curly fibre and polypropylene with latex support and short-fibre polypropylene.

IT Erba sintetica bicolore verde smeraldo e Oliva scuro. Fabbriato con Monofilamenti in Polietilene arricciato e Polipropilene con supporto in Lattice e Polipropilene a fibra corta.

PT Relva artificial, bicolor em verde esmeralda e azeitona escuro, fabricado em monifilo de polietileno de fibra crespa e polipropileno com suporte em Látex e polipropileno de fibra curta.

Ref		DTEX 1	DTEX 2			PUNTADAS		
9001 6540	1 x 4 m	45000	3000	110,25 ± 100	0,4 ± 0,8 mm	23100 g/m <sup>2</sup> ± 10%	1	<b>114,66</b>
9001 6541	2 x 4 m	45000	3000	220,50 ± 100	0,4 ± 0,8 mm	23100 g/m <sup>2</sup> ± 10%	1	<b>229,32</b>
9001 6543	2 x 10 m	45000	3000	532,39 ± 100	0,4 ± 0,8 mm	23100 g/m <sup>2</sup> ± 10%	1	<b>554,31</b>

SGS RoHS



Ocio / Deporte  
Loisir/Sport  
Sports / Leisure  
Tempo libero / Sport  
Lazer / Desporto

Residencial  
Residencial  
Residencial  
Residencial



No tóxico  
Non toxique  
Nontoxic  
Atossico  
NÃO-tóxico

Tratamiento Anti-UV  
Traitement anti-UV  
Anti-UV treatment  
Tratamento anti-UV  
Tratamento anti-UV



Fácil Limpieza  
Nettoyage facile  
Easy cleaning  
Di facile pulizia  
Limpeza fácil

Poliétileno / 100% Reciclabl  
Polyethylene / 100% Recyclabl  
Poliétileno / 100% Reciclabl  
Poliétileno / 100% Reciclav



ES Césped artificial bicolor verde esmeralda y oliva oscuro, fabricado en monofilamento de polietileno de fibra rizada y polipropileno con soporte en látex y polipropileno de fibra corta.

FR Gazon synthétique bicolore vert émeraude et Olive foncé fabriqué en monofilament de Polyéthylène de fibre bouclée et Polypropylène avec support en latex et polypropylène de fibre courte.

EN Two-coloured artificial grass composed of emerald and dark olive green. Made from polyethylene monofilament, curly fibre and polypropylene with latex support and short-fibre polypropylene.

IT Erba sintetica bicolore verde smeraldo e Oliva scuro. Fabbriato con Monofilamenti in Polietilene arricciato e Polipropilene con supporto in Lattice e Polipropilene a fibra corta.

PT Relva artificial, bicolor em verde esmeralda e azeitona escuro, fabricado em monifilo de polietileno de fibra crespa e polipropileno com suporte em Látex e polipropileno de fibra curta.

Ref		DTEX 1	DTEX 2			PUNTADAS		
9001 6590	1 x 4 m	5000	3000	123,10 ± 100	0,8 ± 1,0 mm	25200 g/m <sup>2</sup> ± 10%	1	<b>128,02</b>
9001 6591	2 x 4 m	5000	3000	246,20 ± 100	0,8 ± 1,0 mm	25200 g/m <sup>2</sup> ± 10%	1	<b>256,05</b>
9001 6592	2 x 10 m	5000	3000	597,30 ± 100	0,8 ± 1,0 mm	25200 g/m <sup>2</sup> ± 10%	1	<b>621,19</b>



DISPLAY PARA CÉSPED ARTIFICIAL / DISPLAY POUR GAZON ARTIFICIEL / ESPOSITORE ERBA ARTIFICIALE  
RETE PROTETTIVA VERDE 80% / DISPLAY PARA ERVA ARTIFICIAL



Ref			
9001 6599	1260 x 840 x 550 mm		43,50

MALLA SOMBREO / BRISE VUE MAILLE OCCULTATION / SHADE NETTING  
RETE PROTETTIVA / MALHA OCULTAÇÃO

MALLA SOMBREO VERDE CLARO 80% / BRISE VUE MAILLE OCCULTATION VERTE 80% / 80% SHADE NETTING GREEN  
RETE PROTETTIVA VERDE 80% / MALHA OCULTAÇÃO VERDE 80%

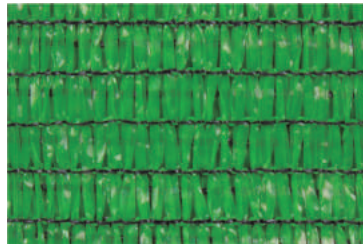

ES Cosido 3 hilos monofilamento por pulgada. Protección anti U.V.  
FR Tressage 3 fils monofilament par pouce. Protection anti U.V.  
EN Sewed with 3 monofilament threads per inch. Anti-U.V. protection.  
IT Cucitura a 3 fili continui in pollici. Protezione anti U.V.  
PT Costura 3 fios mono filamento por polegada. Proteção anti U.V.

80%

PROTECCIÓN  
ANTI U.V.

Ref				
9001 6542	90 grs	2 x 10 m	1	19,35
9001 6545	90 grs	2 x 50 m	1	84,90

MALLA SOMBREO NEGRA 80% / BRISE VUE MAILLE OCCULTATION NOIRE 80% / 80% SHADE NETTING BLACK  
RETE PROTETTIVA NERA 80% / MALHA OCULTAÇÃO PRETA 80%

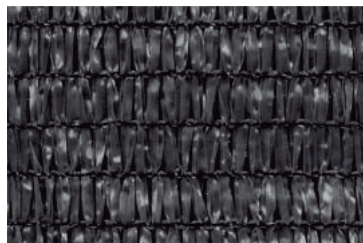

ES Cosido 3 hilos monofilamento por pulgada. Protección anti U.V.  
FR Tressage 3 fils monofilament par pouce. Protection anti U.V.  
EN Sewed with 3 monofilament threads per inch. Anti-U.V. protection.  
IT Cucitura a 3 fili continui in pollici. Protezione anti U.V.  
PT Costura 3 fios mono filamento por polegada. Proteção anti U.V.

80%

PROTECCIÓN  
ANTI U.V.

Ref				
9001 6580	90 grs	4 x 50 m	1	152,35
9001 6581	90 grs	2 x 100 m	1	152,35





MALLA SOMBREO VERDE OSCURO 90% / BRISE VUE MAILLE OCCULTATION VERTE 90% / 90% SHADE NETTING GREEN  
RETE PROTETTIVA VERDE 90% / MALHA OCULTAÇÃO VERDE 90%

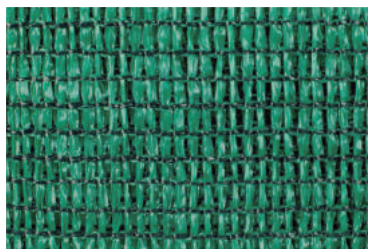

ES Cosido 6 hilos monofilamento por pulgada. Protección anti U.V.  
FR Tressage 6 fils monofilament par pouce. Protection anti U.V.  
EN Sewed with 6 monofilament threads per inch. Anti-U.V. protection.  
IT Cucitura a 6 fili continui in pollici. Protezione anti U.V.  
PT Costura 6 fios mono filamento por polegada. Proteção anti U.V.

90%

PROTECCIÓN ANTI U.V.

Ref					Ref				
9001 6550	120 grs	1 x 10 m	1	12,20	9001 6553	120 grs	1 x 50 m	1	63,50
9001 6551	120 grs	1,5 x 10 m	1	18,50	9001 6554	120 grs	1,5 x 50 m	1	88,25
9001 6552	120 grs	2 x 10 m	1	26,25	9001 6555	120 grs	2 x 50 m	1	127,50

MALLA OCULTACIÓN MARRÓN 90% / BRISE VUE MAILLE OCCULTATION MARRON 90% / 90% SHADE NETTING BROWN  
RETE PROTETTIVA MARRONE 90% / MALHA OCULTAÇÃO CASTANHA 90%

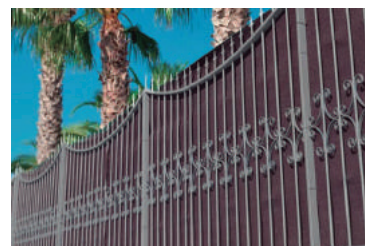
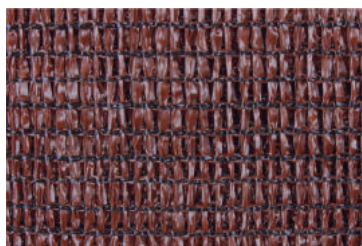

ES Cosido 6 hilos monofilamento por pulgada. Protección anti U.V.  
FR Tressage 6 fils monofilament par pouce. Protection anti U.V.  
EN Sewed with 6 monofilament threads per inch. Anti-U.V. protection.  
IT Cucitura a 6 fili continui in pollici. Protezione anti U.V.  
PT Costura 6 fios mono filamento por polegada. Proteção anti U.V.

90%

PROTECCIÓN ANTI U.V.

Ref				
9001 6563	120 grs	1 x 50 m	1	58,90
9001 6564	120 grs	1,5 x 50 m	1	87,25
9001 6565	120 grs	2 x 50 m	1	119,30





MALLA ANTIHERBAS NEGRA / TOILE ANTI-HERBES NOIRE / LANDSCAPE FABRIC BLACK / MAGLIA ANTIERBA NERA / MALHA ANTI ERVAS NEGRA

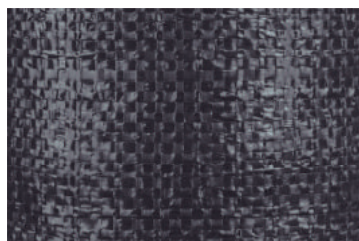

ES Protección anti U.V.  
 FR Protection anti U.V.  
 EN Anti-U.V. protection.  
 IT Protezione anti U.V.  
 PT Proteção anti U.V.

**PROTECCIÓN ANTI U.V.**

Ref				
<b>9001 6570</b>	100 grs	1 x 50 m	1	<b>43,80</b>
<b>9001 6571</b>	100 grs	1 x 100 m	1	<b>87,50</b>
<b>9001 6572</b>	100 grs	1,5 x 50 m	1	<b>65,50</b>
<b>9001 6573</b>	100 grs	2 x 50 m	1	<b>87,50</b>

**MALLA ANTIPÁJAROS / FILETS ANTI-OISEAUX / BIRD NETTING**  
**RETE ANTIUCCELLI / MALHA ANTI-PÁSSAROS**

MALLA ANTIPÁJAROS / FILETS ANTI-OISEAUX / BIRD NETTING / RETE ANTIUCCELLI / MALHA ANTI-PÁSSAROS

**Malla tejida de polietileno alta densidad.**  
**Mesh woven of a high density polyethylene.**

**Estabilizada a los rayos U.V.**  
**UV-resistant material**

**7G/M2**



ES Es una red ligera, robusta y muy suave que actúa como defensa pasiva contra los pájaros, de tal forma que protege los cultivos sin dañar a los animales. No impide la penetración de luz.

FR Il s'agit d'un filet léger, robuste et très doux qui agit comme une défense passive contre les oiseaux, de manière à protéger les cultures sans faire de mal aux animaux. N'empêche pas la pénétration de la lumière.

EN It is a robust lightweight and very soft mesh that act as a passive protection for your grows, protecting them from birds or other animals without damagin. Allows light penetration.

IT Questa rete è leggera, robusta e molto morbida che funge da una protezione passiva contro gli uccelli, in modo tale que protegge le colture senza danneggiare dagli animali. Lascia penetrare la luce.

PT Rede leve, robusta e suave que atua como defesa passiva contra os pássaros, de tal forma que protege as culturas sem magoar os animais. Não impede a penetração da luz.



Ref			
<b>9001 6582</b>	2 x 5 m	1	<b>2,90</b>
<b>9001 6583</b>	2 x 10 m	1	<b>5,20</b>
<b>9001 6584</b>	4 x 6 m	1	<b>5,40</b>
<b>9001 6585</b>	4 x 12 m	1	<b>8,75</b>
<b>9001 6586</b>	8 x 10 m	1	<b>16,95</b>
<b>9001 6587</b>	2 x 250 m	1	<b>90,75</b>
<b>9001 6588</b>	4 x 250	1	<b>118,90</b>



MALLA PLAST. CUADRADA JARDÍN 5 MM VERDE 1X25 M / FILET PLASTIQUE CARRÉ JARDIN 5 MM VERT 1X25 M  
SQUARE PLASTIC MESH GARDEN 5 MM GREEN 1X25 M / RETE QUADRATA IN PLASTICA PER GIARDINO 5MM VERDE 1X25 M  
MALHA PLÁSTICO QUADRADA JARDIM 5MM VERDE 1X25 M

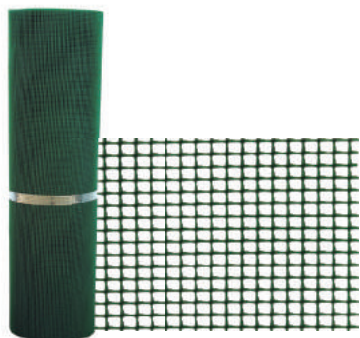

<b>Ref</b>					
<b>1039 1090</b>	Verde	5 mm	1 x 25 m	1	<b>114,80</b>

MALLA PLAST. CUADRADA JARDÍN 5 MM BLANCO 1X25 M / FILET PLASTIQUE CARRÉ JARDIN 5 MM BLANC 1X25 M  
SQUARE PLASTIC MESH GARDEN 5 MM WHITE 1X25 M / RETE QUADRATA IN PLASTICA PER GIARDINO 5 MM BIANCA 1X25 M  
MALHA PLÁSTICO QUADRADA JARDIM 5 MM BRANCO 1X25 M

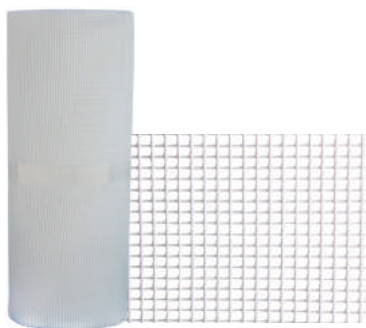

<b>Ref</b>					
<b>1039 1091</b>	Blanco	5 mm	1 x 25 m	1	<b>114,80</b>

MALLA PLAST. CUADRADA JARDÍN 10 MM VERDE 1X25 M / FILET PLASTIQUE CARRÉ JARDIN 10 MM VERT 1X25 M  
SQUARE PLASTIC MESH GARDEN 10 MM GREEN 1X25 M / RETE QUADRATA IN PLASTICA PER GIARDINO 10 MM VERDE 1X25 M  
MALHA PLÁSTICO QUADRADA JARDIM 10 MM VERDE 1X25 M



<b>Ref</b>					
<b>1039 1092</b>	Verde	10 mm	1 x 25 m	1	<b>114,80</b>

MALLA PLAST. CUADRADA JARDÍN 10 MM BLANCO 1X25 M / FILET PLASTIQUE CARRÉ JARDIN 10 MM BLANC 1X25 M  
SQUARE PLASTIC MESH GARDEN 10 MM WHITE 1X25 M / RETE QUADRATA IN PLASTICA PER GIARDINO 10 MM BIANCA 1X25 M  
MALHA PLÁSTICO QUADRADA JARDIM 10 MM BRANCO 1X25 M



<b>Ref</b>					
<b>1039 1093</b>	Blanco	10 mm	1 x 25 m	1	<b>114,80</b>



**MALLA PLÁSTICA / FILET PLASTIQUE / PLASTIC MESH  
RETE IN PLASTICA / MALHA PLÁSTICO**

MALLA PLAST. CUADRADA JARDÍN 10 MM BLANCO 1X25 M / FILET PLASTIQUE CARRÉ JARDIN 10 MM BLANC 1X25 M  
 SQUARE PLASTIC MESH GARDEN 10 MM WHITE 1X25 M / RETE QUADRATA IN PLASTICA PER GIARDINO 10MM BIANCA 1X25 M  
 MALHA PLÁSTICO QUADRADA JARDIM 10MM BRANCO 1X25 M

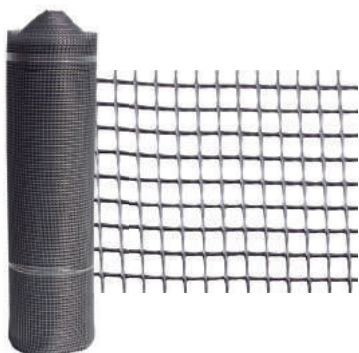

Ref					
<b>1039 1094</b>	Gris Plata	10 mm	1 x 25 m	1	<b>114,80</b>

MALLA PLAST. CUADRADA JARDÍN 10 MM MARRÓN 1X25 M / FILET PLASTIQUE CARRÉ JARDIN 10 MM MARRON 1X25 M  
 SQUARE PLASTIC MESH GARDEN 10 MM BROWN 1X25 M / RETE QUADRATA IN PLASTICA PER GIARDINO 10 MM MARRONE 1X25 M  
 MALHA PLÁSTICO QUADRADA JARDIM 10 MM CASTANHO 1X25 M

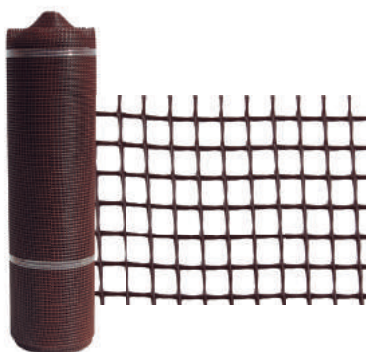

Ref					
<b>1039 1095</b>	Marrón	10 mm	1 x 25 m	1	<b>114,80</b>

MALLA PLAST. CUADRADA JARDÍN 20 MM VERDE 1X25 M / FILET PLASTIQUE CARRÉ JARDIN 20 MM VERT 1X25 M  
 SQUARE PLASTIC MESH GARDEN 20 MM GREEN 1X25 M / RETE QUADRATA IN PLASTICA PER GIARDINO 20 MM VERDE 1X25 M  
 MALHA PLÁSTICO QUADRADA JARDIM 20 MM VERDE 1X25 M



Ref					
<b>1039 1096</b>	Verde	20 mm	1 x 25 m	1	<b>114,80</b>

MALLA PLAST. CUADRADA JARDÍN 20 MM BLANCO 1X25 M / FILET PLASTIQUE CARRÉ JARDIN 20 MM BLANC 1X25 M  
 SQUARE PLASTIC MESH GARDEN 20 MM WHITE 1X25 M / RETE QUADRATA IN PLASTICA PER GIARDINO 20 MM BIANCA 1X25 M  
 MALHA PLÁSTICO QUADRADA JARDIM 20 MM BRANCO 1X25 M



Ref					
<b>1039 1097</b>	Blanco	20 mm	1 x 25 m	1	<b>114,80</b>



TOLDO / BÂCHE / AWNING / TENDA DA SOLE / TOLDO

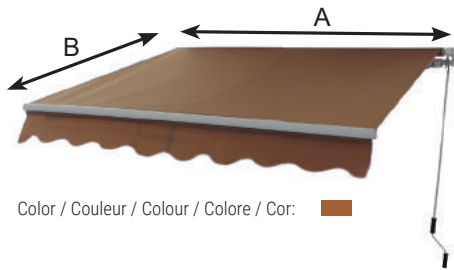

Color / Couleur / Colour / Colore / Cor: ■



Color / Couleur / Colour / Colore / Cor: ■



Color / Couleur / Colour / Colore / Cor: ■ □

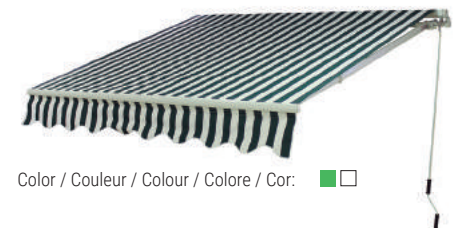

Color / Couleur / Colour / Colore / Cor: ■ □



Práctico y sencillo de montar.  
Pratique et facile a monter.  
Convenient and easy to install.  
Prático e semplice da installare.  
Prático e fácil de montar.



anti uv



Resistente al agua.  
Résistant à l'eau.  
Water resistant.  
Resistente all'acqua.  
Resistente a água.



Alta calidad  
Haute qualité  
High quality  
Alta qualità  
Alta qualidade



Detalle brazo articulado.

Bras articulé.

Articulated arm in detail.

Dettaglio braccio articolato.

Detalhe braço articulado.

Detalle anclaje.

Ancrage.

Anchorage in detail.

Dettaglio ancoraggio.

Fixação.

ES Brazo con doble cable de acero y muelle de alta calidad. Poliéster: 280-300g/m<sup>2</sup>, protección UV, antimoho, revestimiento de PU, impermeable.

FR Bras avec câble double en acier et ressort de haute qualité. Polyester: 280-300g/m<sup>2</sup>, protection UV, antimoisissure, revêtement de PU, imperméable.

EN Double steel cable arm and high quality spring. Polyester: 280-300g/m<sup>2</sup>, UV protection, anti-mould, PU coating, water resistant.

IT Braccio con doppio cavo in acciaio e molla di alta qualità. Poliester: 280-300g/m<sup>2</sup>, protezione UV, antimuffa, rivestimento in PU, impermeabile.

PT Braço com cabo duplo de aço e mola de alta qualidade. Poliéster: 280-300g/m<sup>2</sup>, proteção de UV, anti-bolor, revestimento de PU, impermeável.

ES Manual.  
FR Manuel.  
EN Manual.  
IT Manuale.  
PT Manual.



ES Con motor y mando a distancia.  
FR Avec moteur et commande à distance.  
EN With motor and remote control.  
IT Con motore e comando a distanza.  
PT Com motor e comando à distância.

Ref		MODEL	A	B		
9001 6601	<span style="color: brown;">■</span>	NQ05	2,5 m	2 m	1	364,14
9001 6602	<span style="color: grey;">■</span>	NQ05	2,5 m	2 m	1	364,14
9001 6603	<span style="color: yellow;">■</span> <span style="color: white;">□</span>	NQ05	2,5 m	2 m	1	364,14
9001 6604	<span style="color: green;">■</span> <span style="color: white;">□</span>	NQ05	2,5 m	2 m	1	364,14
9001 6611	<span style="color: grey;">■</span>	NQ05	3 m	2,5 m	1	407,04
9001 6612	<span style="color: yellow;">■</span> <span style="color: white;">□</span>	NQ05	3 m	2,5 m	1	407,04
9001 6613	<span style="color: green;">■</span> <span style="color: white;">□</span>	NQ05	3 m	2,5 m	1	407,04
9001 6620	<span style="color: brown;">■</span>	NQ05	3,5 m	2 m	1	460,57
9001 6621	<span style="color: grey;">■</span>	NQ05	3,5 m	2 m	1	460,57
9001 6622	<span style="color: yellow;">■</span> <span style="color: white;">□</span>	NQ05	3,5 m	2 m	1	460,57
9001 6623	<span style="color: green;">■</span> <span style="color: white;">□</span>	NQ05	3,5 m	2 m	1	460,57
9001 6632	<span style="color: brown;">■</span>	NQ001	4 m	3 m	1	1022,90
9001 6634	<span style="color: grey;">■</span>	NQ001	4 m	3 m	1	1022,90
9001 6642	<span style="color: yellow;">■</span> <span style="color: white;">□</span>	NQ001	4 m	3 m	1	1022,90
9001 6644	<span style="color: green;">■</span> <span style="color: white;">□</span>	NQ001	4 m	3 m	1	1022,90
9001 6631	<span style="color: brown;">■</span>	NQ001	4 m	3 m	1	1205,00
9001 6633	<span style="color: grey;">■</span>	NQ001	4 m	3 m	1	1205,00
9001 6641	<span style="color: yellow;">■</span> <span style="color: white;">□</span>	NQ001	4 m	3 m	1	1205,00
9001 6643	<span style="color: green;">■</span> <span style="color: white;">□</span>	NQ001	4 m	3 m	1	1205,00





SILLÓN INFANTIL AZUL / FAUTEUIL ENFANT BLEU / BLUE ARMCHAIR FOR CHILDREN / POLTRONCINA BLU PER BAMBINI / POLTRONA AZUL CRIANÇAS



ES Resina, apilable, fácil limpieza y almacenaje.  
FR Résine, empilable, nettoyage et stockage facile.  
EN Resin, stackable, easy cleaning and storage.  
IT Resina, impilabile, facile pulizia e conservazione.  
PT Resina, empilhável, fácil limpeza e armazenamento.

Ref						
4305 1003		255 x 295 x 480 mm	600 g	1	60	6,23

SILLA MONOBLOC RESPALDO BAJO / CHAISE MONOBLOC DOSSIER BAS / MONOBLOC CHAIR LOW BACK  
SEDIA MONOBLOCCO, CON SCHIENALE BASSO / CADEIRA MONOBLOCO ENCOSTO BAIXO



ES Resina, apilable, fácil limpieza y almacenaje.  
FR Résine, empilable, nettoyage et stockage facile.  
EN Resin, stackable, easy cleaning and storage.  
IT Resina, impilabile, facile pulizia e conservazione.  
PT Resina, empilhável, fácil limpeza e armazenamento.

Ref					
4305 1001		765 x 550 x 445 mm	2,3 kg	4	17,82
4305 1002		765 x 550 x 445 mm	2,3 kg	4	17,82

MESA OVAL / TABLE OVALE / OVAL DINING TABLE / TAVOLO OVALE / MESA OVAL



ES Hueco central para sombrillas. Resina, apilable, fácil limpieza y almacenaje. Regulador de altura en una pata.  
FR Cavité centrale pour parasols. Résine, empilable, nettoyage et stockage. Régulateur de hauteur sur un pied.  
EN Umbrella hole in the middle. Resin, stackable, easy cleaning and storage. Height regulator in one leg.  
IT Foro centrale per ombrelli. Resina, impilabile, facile da pulire e conservare. Regolabile in altezza.  
PT Buraco central para sombrinhas. Resina, empilhável, fácil limpeza e armazenamento, regulador de altura de uma pata.

Ref					
4305 1004		700 x 1300 x 900 mm	6,5 kg	1	61,08
4305 1005		700 x 1300 x 900 mm	6,5 kg	1	63,28





SILLÓN RATÁN ANTRACITA / FAUTEUIL ANTHRACITE RATAN / RATTAN ARMCHAIR ANTHRACITE COLOUR  
POLTRONA RATTAN ANTRACITE / PULTRONA RATÁN ANTRACITE



**Mod. Elegante**

Tecnopolímero + Fibra de vidrio



<b>Ref</b>			
<b>4305 1006</b>	50 x 58 x 84 cm	1	<b>39,24</b>

MESA RECTANGULAR RATÁN ANTRACITA / TABLE RECTANGULAIRE ANTHRACITE RATAN / RECTANGULAR RATTAN ANTHRACITE COLOUR  
TAVOLO RETTANGOLARE POLTRONA RATTAN ANTRACITE / MESA RECTANGULAR PULTRONA RATÁN ANTRACITE



**Mod. Elegante**

Tecnopolímero + Fibra de vidrio

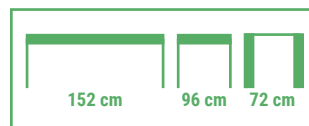

<b>Ref</b>			
<b>4305 1007</b>	152 x 96 x 72 cm	1	<b>204,34</b>

MESA CUADRADA RATÁN ANTRACITA / TABLE CARRÉE ANTHRACITE RATAN / SQUARE RATTAN ANTHRACITE COLOUR  
TAVOLO QUADRATO POLTRONA RATTAN ANTRACITE / MESA QUADRADA PULTRONA RATÁN ANTRACITE



**Mod. Elegante**

Tecnopolímero + Fibra de vidrio

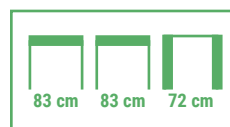

<b>Ref</b>			
<b>4305 1008</b>	83 x 83 x 72 cm	1	<b>100,25</b>



NEVERA TÉRMICA RÍGIDA CON ASA / GLACIERE THERMIQUE RIGIDE AVEC DES ASA / THERMAL COOL BOX WITH HANDLE  
FRIGORÍFERO TERMICO RIGIDO CON MANICO / FRIGORIFICO TÉRMICO RIGIDO COM ASA



28 L

Ref					
4305 1010	440 x 280 x 374 mm	28 L	2 kg	1	35,00

SILLÓN PLEGABLE FIJO LACADO FIBRELINE AZUL / FAUTEUIL PLIANT FIXE LAQUE FIBRELINE BLEU  
FIXED AND FOLDING LACQUERED ARMCHAIR, BLUE FIBRELINE / POLTRONA PIEGHEVOLE FISSA LACCATA FIBRELINE BLU  
CADEIRA FIXA AZUL DE DOBRADIÇA FIXA AZUL FIBRELINE



Acero lacado blanco.  
Ø tubo: 1,5 cm.

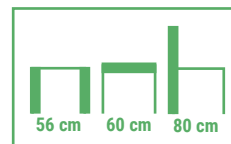

Ref				
4305 1031	800 x 600 x 56 mm	2,5 kg	4	28,20

TUMBONA JARDÍN AZUL ACERO ACOLCHADA / CHAISE LONGUE DE JARDIN BLEU ACIER / BLUE STEEL GARDEN LOUNGER, PADDED  
SEDIA A SDRAIO GIARDINO BLU ACCIAIO IMBOTTITA / ESPREGUIÇADEIRA AZUL JARDIM AÇO ACOLCHOADO



Posabrazos doble tapa.  
Tubo de acero oval 40 x 20 mm.

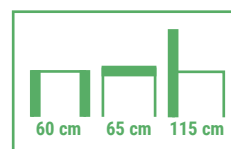

Ref				
4305 1032	1150 x 650 x 600 mm	5,5 kg	1	90,49

SILLA/CAMA PLAYA FIBRELINE AZUL CON ASA ALUMINIO / CHAISE/LIT DE PLAGE FIBRELINE BLEU AVEC POIGNEE ALUMINIUM  
BEACH CHAIR/BED BLUE FIBRELINE WITH ALUMINIUM HANDLE / SEDIA/LETTO SPIAGGIA FIBRELINE BLU CON MANICO IN ALLUMINIO  
CADEIRA / CAMA PRAIA FIBRELINE AZUL COM ASA DE ALUMÍNIO



Pata trasera plegable.

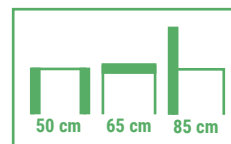

Ref				
4305 1033	850 x 650 x 500 mm	3,5 kg	2	51,95



MESA PLEGABLE RECTANGULAR BLANCA / TABLE PLIABLE RECTANGULAIRE BLANCHE / FOLDING RECTANGULAR WHITE TABLE  
TAVOLO PIEGHEVOLE BIANCO RETTANGOLARE / MESA DOBRÁVEL BRANCA RETANGULAR

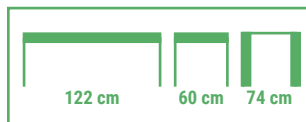
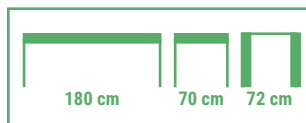

Ref			
<b>4305 1011</b>	180 x 70 x 72 cm	1	<b>79,20</b>
<b>4305 1012</b>	122 x 60 x 74 cm	1	<b>72,00</b>

BANCO PLEGABLE RECTANGULAR BLANCO / BANC PLIABLE RECTANGULAIRE BLANC / FOLDING RECTANGULAR WHITE BENCH  
PANCHINA PIEGHEVOLE RETTANGOLARE BIANCA / BANCO DOBRÁVEL RETANGULAR BRANCO

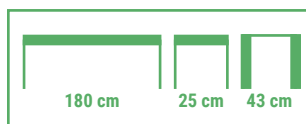

Ref			
<b>4305 1013</b>	180 x 25 x 43 cm	1	<b>64,35</b>

SILLA PLEGABLE BLANCA / CHAISE PLIABLE BLANCHE / FOLDING WHITE CHAIR / SEDIA PIEGHEVOLE BIANCA / CADEIRA DOBRÁVEL BRANCA



Ref			
<b>4305 1014</b>	46 x 53 x 86 cm	4	<b>36,00</b>



MESA PLEGABLE CUADRADA BLANCA / TABLE PLIABLE CARRÉE BLANCHE / FOLDING SQUARE WHITE TABLE  
TAVOLO QUADRATO PIEGHEVOLE BIANCO / MESA DOBRÁVEL QUADRADA BRANCA

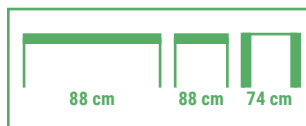

Ref			
4305 1015	88 x 88 x 74 cm	1	72,90

TABURETE PLEGABLE BLANCO / TABOURET PLIABLE BLANC / FOLDING WHITE STOOL  
SGABELLO PIEGHEVOLE BIANCO / TAMBORETE DOBRÁVEL BRANCO

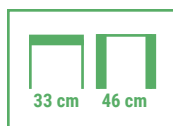

Ref			
4305 1016	33 x 30 x 46 cm	4	18,90

MESA REDONDA PLEGABLE BLANCA / TABLE RONDE PLIABLE BLANCHE / FOLDING ROUND WHITE TABLE  
TAVOLO BIANCO ROTONDO PIEGHEVOLE / MESA REDONDA DOBRÁVEL BRANCA

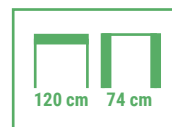
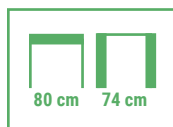

Ref			
4305 1017	∅80 x 74 cm	1	66,60
4305 1018	∅120 x 74 cm	1	99,45



Ref			
4305 1019	∅180 x 74 cm	1	182,70



MESA ALTA PLEGABLE BLANCA / TABLE HAUTE PLIABLE BLANCHE / FOLDING WHITE BAR TABLE  
TAVOLO BIANCO ALTO PIEGHEVOLE / MESA ALTA DOBRÁVEL BRANCA

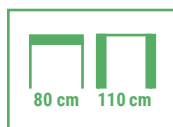

Ref			
4305 1020	80 x 110 cm	1	70,20

SILLA ALTA PLEGABLE BLANCA / CHAISE HAUTE PLIABLE BLANCHE / FOLDING WHITE BAR CHAIR  
SEDIÀ ALTA PIEGHEVOLE BIANCA / CADEIRA ALTA DOBRÁVEL BRANCA



Ref			
4305 1021	57 x 44 x 109 cm	4	44,55

CUBIERTA DE MESA BAR / PROTECTION DE TABLE BAR / FOLDING BAR TABLE COVER / PROTEZIONE TAVOLO BAR / PROTETOR MESA BAR



Para Ref.: 4305 1020  
For Ref.: 4305 1020

Ref			
4305 1022	Negra - Black	1	22,50
4305 1023	Blanca - White	1	22,50
4305 1024	Roja - Red	1	22,50





PARRILLAS / GRILLE / GRILL / GRIGLIE / GRELHAS



**REVERSIBLES**

Cromadas giratorias / Rotative chromée / Chrome rotating / Girevole, cromata / Cromadas giratórias

Ref	↔	▨	📦
<b>4100 5036</b>	560 x 400 mm	1	<b>54,53</b>

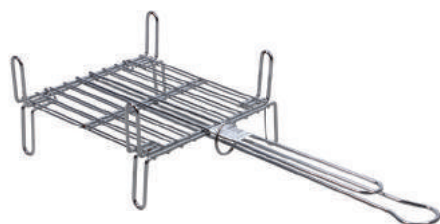

**CROMADAS**

Cromadas / Chromée / Chrome / Cromata / Cromadas

Ref	↔	▨	📦	📦
<b>4100 2525</b>	250 x 250 mm	1	5	<b>10,61</b>
<b>4100 3030</b>	300 x 300 mm	1	5	<b>12,79</b>
<b>4100 3535</b>	350 x 350 mm	1	5	<b>15,03</b>
<b>4100 4040</b>	400 x 400 mm	1	5	<b>17,26</b>
<b>4100 4545</b>	450 x 450 mm	1	5	<b>19,73</b>
<b>4100 5050</b>	500 x 500 mm	1	5	<b>23,87</b>

**INOX**

Inox / Inox / Inox / Inox / Inox

Ref	↔	📦	📦
<b>4200 2525</b>	250 x 250 mm	1	<b>51,05</b>
<b>4200 3030</b>	300 x 300 mm	1	<b>58,34</b>
<b>4200 3535</b>	350 x 350 mm	1	<b>75,35</b>
<b>4200 4040</b>	400 x 400 mm	1	<b>89,94</b>
<b>4200 4545</b>	450 x 450 mm	1	<b>109,38</b>
<b>4200 5050</b>	500 x 500 mm	1	<b>126,40</b>

PINZA BARBACOA INOXIDABLE CON PALA / PINCES BARBECUE INOXYDABLES PLATES / STAINLESS STEEL BARBECUE TONGS WITH FORK  
PINZA INOSSIDABILE PER BARBECUE CON FORCHETTA / PINÇA DE CHURRASCO INOXIDÁVEL COM PEGAS

**INOX**



Ref	↔	📦	📦
<b>4100 1001</b>	340 mm	1	<b>8,18</b>
<b>4100 1002</b>	380 mm	1	<b>8,88</b>
<b>4100 1003</b>	500 mm	1	<b>10,65</b>

PINZA BARBACOA INOXIDABLE / PINCES BARBECUE INOXYDABLES PLATES / STAINLESS STEEL BARBECUE TONGS  
PINZA INOSSIDABILE PER BARBECUE / PINÇA DE CHURRASCO INOXIDÁVEL

**INOX**



Ref	↔	📦	📦
<b>4100 1004</b>	340 mm	1	<b>7,54</b>
<b>4100 1005</b>	380 mm	1	<b>8,10</b>
<b>4100 1006</b>	500 mm	1	<b>10,05</b>

PINCHO INOXIDABLE / PICS BROCHETTES INOXYDABLES / STAINLESS STEEL SKEWER / SPIEDINI INOSSIDABILI / ESPETO INOXIDÁVEL

**INOX**



Ref	↔	📦	📦
<b>4100 1007</b>	300 mm	20	<b>0,78</b>
<b>4100 1008</b>	350 mm	20	<b>0,89</b>
<b>4100 1009</b>	400 mm	20	<b>0,98</b>



BARBACOA ACERO CARBÓN Y LEÑA / BARBECUE ACIER CHARBON ET BOIS / STEEL BARBECUE CHARCOAL AND FIREWOOD  
 BARBECUE IN ACCIAIO, PER CARBONE E LEGNA / BARBECUE AÇO CARVÃO E LENHA

**MOD. BARCENA**



ES Barbacoa "Modelo Barcena" de carbón y leña fabricada en chapa de acero 2 mm, cuenta con cajón recoge cenizas y una parrilla metálica inox regulable para los alimentos. Ideal para cocinar en el exterior por su ligereza y robustez.

FR Barbecue "Modèle Barcena" charbon et bois fabriqué avec une plaque d'acier de 2 mm, tiroir de récupération des cendres et grille métallique inox réglable pour les aliments. Idéal pour cuisiner à l'extérieur, léger et robuste.

EN Barbecue "Model Barcena" for charcoal and firewood, made of 2 mm-steel sheet, consists of an ash drawer and an adjustable stainless steel metallic grill for food. Suitable for cooking outdoors thanks to its lightness and sturdiness.

IT Barbecue "Modello Barcena" per carbone e legna, prodotto in lamiera d'acciaio 2 mm. Dotato di cassetto per la raccolta delle ceneri e di griglia in metallo inox regolabile in funzione degli alimenti. Ideale per la cottura in ambienti esterni grazie alla sua leggerezza e robustezza.

PT Barbecue "Modelo Barcena" de carvão e lenha feito em chapa de aço de 2 mm, tem depósito de cinzas e uma grade de metal ajustável inoxidável para alimentos. Ideal para cozinhar no exterior por ser leve e resistente.

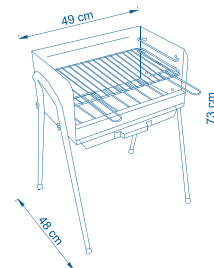

Ref			
4300 1501	490 x 480 mm	1	89,90

**MOD. GOMERA**



ES Barbacoa "Modelo Gomera" de carbón y leña fabricada en chapa de acero 2 mm, cuenta con cajón recoge cenizas, bandeja rejilla inferior y doble plancha/parrilla metálica en acero inoxidable regulable para los alimentos. Sistema de elevación con mango y cadena de la parrilla. Ideal para cocinar en el exterior por su estabilidad y robustez.

FR Barbecue "Modèle Gomera" charbon et bois fabriqué avec une plaque en acier de 2 mm, tiroir de récupération des cendres, plateau - grille inférieur et double plancha avec grille métallique en acier inoxydable réglable pour les aliments. Système d'élévation de la grille avec manche et chaîne. Idéal pour cuisiner à l'extérieur, stable et robuste.

EN Barbecue "Model Gomera" for charcoal and firewood, made of 2 mm-steel sheet, consists of an ash drawer, an inferior grille tray and double griddle with an adjustable stainless steel metallic grill for food. Suitable for cooking outdoors thanks to its lightness and sturdiness.

IT Barbecue "Modello Gomera" per carbone e legna, prodotto in lamiera d'acciaio 2 mm. Dotato di cassetto per la raccolta delle ceneri, ripiano inferiore e griglia metallica doppia in acciaio inox, regolabile in funzione degli alimenti. Sistema di regolazione tramite maniglia e catena. Ideale per la cottura in ambienti esterni grazie alla sua leggerezza e robustezza.

PT Barbecue "Modelo Gomera" de carvão e lenha feito em chapa de aço de 2 mm, tem depósito de cinzas e uma bandeja em grade inferior e dupla grade de metal ajustável inoxidável para alimentos. Sistema de elevação com cabo e correia da grade. Ideal para cozinhar no exterior por ser leve e resistente.

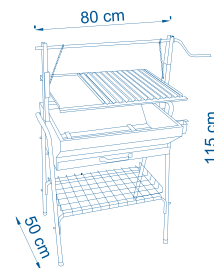

Ref			
4300 1510	800 x 500 mm	1	270,10



LEÑERO RUEDAS Y ACCESORIOS CHIMENEA / PORTE-BUCHES A ROULETTES ET ACCESSOIRES CHEMINÉE / FIREWOOD TROLLEY AND CHIMNEY ACCESSORIES  
CONTENITORE CON RUOTE PER LEGNA ED ADDESSORI CAMINETTO / CARRINHO PARA LENHA COM ACESSÓRIOS PARA A LAREIRA



- Incluye / Contient / Includes / Include / Includi:
- ES - Palo recoge-cenizas.
  - Cepillo de alambre.
  - Gancho metálico.
  - FR - Pelle pour récupérer les cendres.
  - Brosse métallique.
  - Crochet métallique.
  - EN - Ash shovel.
  - Wire brush.
  - Metal hook.
  - IT - Paletta raccogli cenere.
  - Spazzola metallica.
  - Gancio metallico.
  - PT - Recolhedor de cinzas.
  - Escova de aço.
  - Gancho metálico.

Ref			
4300 3001	810 x 350 x 300 mm	1	59,64

BRIQUETAS DE MADERA P/CHIMENEAS Y ESTUFAS / BRIQUETTES DE BOIS P/CHEMINEES ET POELES  
WOOD BRIQUETTES FOR CHIMNEYS AND BURNING STOVES / BRICCHETTI IN LEGNO PER CAMINI E STUFF  
BRIQUETES DE MADEIRA P/CHAMINES E SALAMANDRAS



Ref				
4305 0106	7 kg	1	160	6,45

BOLSA CARBÓN EN BRIQUETAS AUTOENCENDIBLE / SAC DE CHARBON EN BRIQUETTES ALLUMAGE AUTOMATIQUE  
SELF-LIGHTING BAG OF COAL BRIQUETTES / SACCHETTO BRICCHETTI DI CARBONE, FACILE ACCENSIONE  
SACO CARVÃO EM BRIQUETES AUTOACENDIVEL



Ref				
4305 0112	1,5 kg	1	10	5,82

BOLSA BRIQUETAS CARBÓN VEGETAL 3KG / SAC BRIQUETTES 3 KG / BAG OF BRIQUETTES 3 KG / SACCHETTO BRICCHETTI 3KG / SACO BRIQUETES 3 KGS



- ES No produce residuos, alto poder calorífico. Brasa más duradera que la del carbón.
- FR Ne produit pas de déchet. Fort pouvoir calorifique. Braise plus durable que celle du charbon.
- EN They do not leave any residue. High calorific value. Embers are longer-lasting than charcoal ones.
- IT Non lascia residui. Alto potere calorifico. Brace più durevole.
- PT Não produzem residuos. Alto poder calorífico. Brasa mais duradeira que a do carvão.

Ref				
4305 0110	3 Kg	32 uds	1	3,22



BOLSA CARBÓN VEGETAL 3KG / SAC CHARBON VÉGÉTAL 3 KG / BAG OF CHARCOAL 3 KG  
SACCHETTO CARBONE VEGETALE 3KG / SACO CARVÃO VEGETAL 3KLG



**Bricofan**

ES Fácil encendido, larga duración de brasa.  
FR Allumage facile. Longue durée de la braise.  
EN Easy lighting. Long-lasting embers.  
IT Facile accensione. Brace di lunga durata.  
PT Fácil acender. Larga duração da brasa.

Ref				
4305 0103	3 Kg	32 uds	1	5,80

BARBACOA INSTANTÁNEA / PLATEAU BARBECUE UTILISATION UNIQUE / DISPOSABLE BARBECUE GRILL  
VASSOIO BARBECUE MONOUSO / CHURRASQUEIRA BANDEIJA UM SÓ USO



**Bricofan**

**1 1/2 h**  
DE BRASA - DE BRAISE  
OF EMBERS - DE BRASA

**20 min**  
LISTO - PRÊT - READY - USAR

**3/4**  
PERSONAS - PERSONNES  
PEOPLE - PESSOAS

ES Ideal para picnics, camping, pesca, jardines y caza.  
FR Idéal pour picnics, camping, pêche, jardins et chasse.  
EN Ideal for picnic, camping, fishing, gardens and hunting.  
IT Ideale per picnic, campeggio, pesca, giardini e caccia.  
PT Ideal para picnics, camping, pesca e jardins e caça.

Ref			
4305 0101	1	10	7,40

PASTILLA ENCENDIDO 32 UNDS / PASTILLE D'ALLUMAGE 32 PIÈCES / FIRELIGHTER 32 PCS  
PASTIGLIE DI ACCENSIONE 32 PEZZI / PASTILHA ACENDER 32 UNDS



**Bricofan**

Ref			
4305 0115	32 uds	1	24
			1,87

PASTILLAS DE ENCENDIDO MADERA ECOLÓGICA 32 PIEZAS / PASTILLE D'ALLUMAGE BOIS ECOLOG 32 PIÈCES / FIRELIGHTER ECOLOGICAL WOOD 32 PCS  
PASTIGLIE DI ACCENSIONE LEGNO, ECOLOG. 32 PEZZI / PASTILHA ACENDER MADEIRA ECOLOG. 32 UNDS



**Bricofan**



Ref			
4305 0116	32 uds	1	24
			1,60



LÍQUIDO ENCENDIDO EXTRA SIN RETROCESO / LIQUIDE ALLUMAGE SUPPLÉMENTAIRE SANS RETROC. / LIGHTER FLUID EXTRA, NO FLASHBACK  
 LIQUIDO ACCENSIONE SENZA RITORNO DI FIAMMA / LIQUIDO ACENDER EXTRA SEM RETROC.



**Bricofan**

- ES Fácilmente inflamable, pero sin efecto retrallama. Encendido de chimeneas, estufas, calderas y barbacoas.
- FR Facilement inflammable, ne produit pas de retour de flamme. Il est destiné à allumer des cheminées, des poêles à bois et des barbecues.
- EN Highly flammable; however, it will not flash. It is intended to light your fireplace, wood burning stove, and barbecue.
- IT Facilmente infiammabile, ma evita i ritorni di fiamma. È adatto per accendere gli caminetti, le stufa a legna e le grigliate.
- PT Facilmente inflamável, sem risco de esplusão. Destinado a chaminés, estufas e barbecues.

Ref				
4305 0117	1 l	1	6	5,46

GEL ENCENDIDO / GEL ALLUMAGE / LIGHTING GEL / GEL DI ACCENSIONE / GEL PARA ACENDER



**Bricofan**

- ES Ideal para encender barbacoas, chimeneas y estufas, sin olores desagradables.
- FR Est idéal dans l'allumage des cheminées et des poêles à bois, sans odeur désagréables.
- EN It is perfect to light your fireplace and burning stove, odorless.
- IT È ideale per accendere gli caminetti e le stufe a carbone ed è inodore.
- PT Ideal para acender barbecues, chaminés e estufas, sem cheiros desagradáveis.

Ref				
4305 0119	750 ml	1	12	7,36

ACEITE CITRONELA / HUILE CITRONELLE / CITRONELLA OIL / OLIO CITRONELLA / OLEO CITRONELA



**Bricofan**

- ES Ideal para antorchas y lámparas de exterior. Sin retroceso de llama.
- FR Idéal pour les torches. Lampes d'extérieur. Sans retour de flamme.
- EN Ideal for torches. Outdoor lamps. No flashback.
- IT Ideale per torce. Lampade per esterni. Senza ritorno di fiamma.
- PT Ideal para tochas. Lâmpadas de exterior. Sem flashback.

Ref				
4305 0118	1 L	1	6	7,90





TIJERA RECOLECCIÓN CURVA / CISEAU RÉCOLTE COURBE / BYPASS PRUNING SHEARS CURVED  
FORBICI RACCOLTA CURVE / TESOURA DE PODAR CURVA



- ES Punta curva
- FR Pointe courbée
- EN Curved blade
- IT Punta curva
- PT Ponta curvada

ES Acero de calidad con alto grado de dureza. Hoja de corte rectificada. Mango con diseño ergonómico. Consejos de mantenimiento: mantenga siempre las hojas limpias, secas y sin ningún residuo o suciedad después de cada uso. Para evitar la oxidación, limpie con un aceite multiusos todos los componentes metálicos y filos cortantes. Afíle las hojas periódicamente. Mantenerlas afiladas le dará un corte limpio y consistente. El mantenimiento adecuado alarga la vida de sus herramientas. Precaución: Cuidado con los filos cortantes. Siempre use guantes y protección ocular.

FR Acier de qualité, qualité renforcée. Lame de coupe affûtée. Manche avec design ergonomique. Conseils pour l'entretien: Gardez toujours les lames propres, sèches et sans aucun résidu ou saleté après chaque utilisation. Pour éviter l'oxydation, nettoyez avec une huile multiusage tous les composants métalliques et les bords coupants. Aiguissez les lames régulièrement. Si vous les gardez aiguisées, vos coupes sont propres et efficaces. Un entretien approprié allonge la durée de vie des outils. Précaution: Attention aux bords tranchants. Utilisez des gants de sécurité et une protection oculaire.

EN Quality steel with high degree of hardness. Precision ground blade. Ergonomic handle design. Maintenance tips: Always keep the blades clean, dry and free of residue or dirt after each use. To prevent rusting, spray all metal components and cutting edges with multi-purpose oil. Sharpen the blades periodically. Keeping the blades sharp will give you a consistently clean cut. Proper maintenance extends the life of your tools. Caution: Beware of sharp edges. Always wear gloves and eye protection.

IT Acciaio di qualità ad elevato grado di durezza. Lama da taglio rettificata. Impugnatura ergonomica. Consigli di manutenzione: Conservare sempre le lame pulite, asciutte e senza residui o sporchie dopo qualsiasi utilizzo. Per prevenire la formazione di ruggine, pulire con aceto multiuso tutti i componenti metallici e le parti taglienti. Affilare regolarmente le lame. Tenerle affilate garantirà un taglio netto e preciso. La manutenzione adeguata allunga la vita delle proprie attrezzature. Attenzione: Attenzione ai bordi taglienti. Indossare sempre guanti ed occhiali protettivi.

PT Aço de qualidade com um alto grau de dureza. Lâmina de corte retificada. Cabo com desenho ergonómico. Conselhos de manutenção: Manter as lâminas sempre limpas, secas e sem qualquer resíduo ou sujidade depois de cada uso. Para prevenir a oxidação, limpe com óleo multiusos todos os componentes de metal e as arestas cortantes. Afie as lâminas regularmente. Mantê-las afiladas dará um corte limpo e consistente. A manutenção adequada aumenta a vida útil das suas ferramentas. Cuidado: Cuidado com as arestas cortantes. Use sempre luvas e óculos de proteção.

Ref	↔	📦	📦	📦	📦
9001 0805	165 m	1	10	6,37	✓

TIJERA RECOLECCIÓN 165 MM RECTA / SÉCATEUR 165 MM DROIT / PRUNING SHEARS 165 MM STRAIGHT  
FORBICE DA RACCOLTA, PUNTA DRITTA 165 MM / TESOURA DE PODAR 165 MM RETA



ES Acero de calidad con alto grado de dureza. Hoja de corte rectificada. Mango con diseño ergonómico. Consejos de mantenimiento: mantenga siempre las hojas limpias, secas y sin ningún residuo o suciedad después de cada uso. Para evitar la oxidación, limpie con un aceite multiusos todos los componentes metálicos y filos cortantes. Afíle las hojas periódicamente. Mantenerlas afiladas le dará un corte limpio y consistente. El mantenimiento adecuado alarga la vida de sus herramientas. Precaución: Cuidado con los filos cortantes. Siempre use guantes y protección ocular.

FR Acier de qualité, qualité renforcée. Lame de coupe affûtée. Manche avec design ergonomique. Conseils pour l'entretien: Gardez toujours les lames propres, sèches et sans aucun résidu ou saleté après chaque utilisation. Pour éviter l'oxydation, nettoyez avec une huile multiusage tous les composants métalliques et les bords coupants. Aiguissez les lames régulièrement. Si vous les gardez aiguisées, vos coupes sont propres et efficaces. Un entretien approprié allonge la durée de vie des outils. Précaution: Attention aux bords tranchants. Utilisez des gants de sécurité et une protection oculaire.

EN Quality steel with high degree of hardness. Precision ground blade. Ergonomic handle design. Maintenance tips: Always keep the blades clean, dry and free of residue or dirt after each use. To prevent rusting, spray all metal components and cutting edges with multi-purpose oil. Sharpen the blades periodically. Keeping the blades sharp will give you a consistently clean cut. Proper maintenance extends the life of your tools. Caution: Beware of sharp edges. Always wear gloves and eye protection.

IT Acciaio di qualità ad elevato grado di durezza. Lama da taglio rettificata. Impugnatura ergonomica. Consigli di manutenzione: Conservare sempre le lame pulite, asciutte e senza residui o sporchie dopo qualsiasi utilizzo. Per prevenire la formazione di ruggine, pulire con aceto multiuso tutti i componenti metallici e le parti taglienti. Affilare regolarmente le lame. Tenerle affilate garantirà un taglio netto e preciso. La manutenzione adeguata allunga la vita delle proprie attrezzature. Attenzione: Attenzione ai bordi taglienti. Indossare sempre guanti ed occhiali protettivi.

PT Aço de qualidade com um alto grau de dureza. Lâmina de corte retificada. Cabo com desenho ergonómico. Conselhos de manutenção: Manter as lâminas sempre limpas, secas e sem qualquer resíduo ou sujidade depois de cada uso. Para prevenir a oxidação, limpe com óleo multiusos todos os componentes de metal e as arestas cortantes. Afie as lâminas regularmente. Mantê-las afiladas dará um corte limpo e consistente. A manutenção adequada aumenta a vida útil das suas ferramentas. Cuidado: Cuidado com as arestas cortantes. Use sempre luvas e óculos de proteção.

Ref	↔	📦	📦	📦	📦
9001 0806	165 m	1	10	6,23	✓



TIJERAS DE RECOLECCIÓN PUNTA RECTA 205 mm (8") / SÉCATEUR 205 mm (8") / NEEDLE NOSE FRUIT PRUNER 205 mm (8")  
FORBICE A MOLLA, PUNTA DRITTA DA 205 mm (8") / TESOURAS DE PODAR DE PONTA RETA 205 mm (8")



ES Tijeras de recolección 205 mm (8"). Hoja de acero inoxidable, mango bañado en plástico antideslizante, cierre de seguridad.  
FR Sécateur 205 mm (8"). Lame acier inox, poignée bain plastique antidérapant, fermeture sécurisée.  
EN Fruit pruner 205 mm (8"). High carbon steel blades, plastic handles, locking device.  
IT Forbice a molla punta dritta da 205 mm (8"). Lame in acciaio inossidabile, corpo trattato ad alta temperatura, finitura lucida, manico in bagno di plastica antiscivolo.  
PT Podador de 205 mm (8"). Lâminas de aço inoxidável, pegas de plástico anti-deslizante, dispositivo de bloqueio.

Ref					
9001 0803	Tijeras / Sécateur / Pruner / Forbice / Tesouras	1	10	10,08	✓

Ref					
9001 080301	Tornillo / Vis / Screw / Vite / Parafuso		1	1,50	
9001 080302	Tuerca / Écrou / Nut / Dado / Porca		1	0,05	

TIJERAS DE RECOLECCIÓN PUNTA RECTA Y CURVA 185 mm / SÉCATEUR 185 mm / NEEDLE NOSE FRUIT PRUNER 185 mm  
FORBICE A MOLLA, PUNTA DRITTA E CURVA DA 185 mm / TESOURAS DE PODAR DE PONTA RETA E CURVA 185 mm



Ref					
9001 0607	Curva / Courbé / Bent / Curva / Curva	1	10	7,24	✓
9001 0608	Recta / Droit / Straight / Dritta / Reta	1	10	6,46	✓

Ref					
9001 060701	Muelle recambio / Ressort de rechange Spare spring / Molla ricambio / Mola de reposição		5	0,99	

TIJERA RECOLECCIÓN RECTA 185 mm INOX / SÉCATEUR, DROIT 185 mm INOX / FRUIT PRUNER, STRAIGHT 185 mm STAINLESS STEEL  
FORBICE A MOLLA, PUNTA DRITTA, 185 mm INOX / TESOURAS DE PODAR DE PONTA RETA 185 mm INOX

**INOX**



Ref					
9001 0609	Recta / Droit / Straight / Dritta / Reta	1	10	8,31	✓

Ref					
9001 060901	Muelle recambio / Ressort de rechange Spare spring / Molla ricambio / Mola de reposição		5	0,99	

TIJERAS DE RECOLECCIÓN FORJADAS 200 mm (8") / SÉCATEUR 200 mm (8") / FORGED TRIMMER PRUNING SHEARS 200 mm (8")  
FORBICE POTATURA 200 mm (8") / TESOURAS DE PODAR 200 mm (8")



Ref					
9001 3160	Tijeras / Sécateur / Pruner / Forbice / Tesouras	1	10	8,79	✓



TIJERAS DE RECOLECCIÓN 190 mm MANGO FIBRA / CISEAUX DE RÉCOLTE 190 mm / 190 mm BYPASS PRUNING SHEARS  
FORBICE DA POTATURA 190 mm, MANICO IN FIBRA / TESOURAS DE PODAR 190 mm PEGAS EM FIBRA



Ref	↔	📦	📦	📦	📦
9001 8071	190 mm	1	10	6,01	✓

TIJERAS DE RECOLECCIÓN 185 mm MANGO FIBRA / CISEAUX DE RÉCOLTE 185 mm / 185 mm BYPASS PRUNING SHEARS  
FORBICE A CRICCHETTO A 185 mm / TESOURAS DE PODAR 185 mm PEGAS EM FIBRA



Ref	↔	📦	📦	📦	📦
9001 8070	185 mm	1	10	6,01	✓

TIJERAS DE RECOLECCIÓN 205 mm (8") / SÉCATEUR 205 mm (8") / MIDDLE FORGED BYPASS PRUNING SHEARS 205 mm (8")  
FORBICE A MOLLA DA 205 mm (8") / TESOURAS DE PODAR 205 mm (8")



ES Tijeras de recolección 205 mm (8"), forjadas, acabado pulido, mango bañado en vinil antideslizante.  
FR Sécateur 205 mm (8"), ciseaux forges, finition poulie, poignée bain vinyle antidérapant.  
EN Middle forged bypass pruning shears 205 mm (8"), drop forged construction, polish finish, handle non-slip vinyl coated.  
IT Forbice a molla da 205 mm (8") lame in acciaio inossidabile, finitura lucida, manico in bagno di plastica antiscivolo.  
PT Tesouras de podar 205 mm (8") forjadas, acabamento polido, pegas com revestimento de vinil antiderrapante.

Ref	✍	📦	📦	📦	📦
9001 3124	Tijeras / Sécateur / Pruner / Forbice / Tesouras	1	10	10,45	✓

Ref	✍	📦	📦
9001 3125	Muelle recambio / Ressort de rechange Spare spring / Molla ricambio / Mola de reposição	5	0,99

TIJERAS DE CARRACA 3 CORTES / SÉCATEUR À 3 POSITIONS / RATCHET PRUNING SHEARS, 3 POSITIONS  
FORBICE A CRICCHETTO A 3 POSIZIONI / TESOURAS DE CATRACA 3 CORTES



ES Tijeras de carraca 3 cortes. Cuchilla superior: Acero alto porcentaje de carbono, bañado al teflón antideslizante. Cuchilla inferior: Acero al carbono, mangos de aluminio bañado en TPR antideslizante. Capacidad de corte: 20 mm. Diseño: 3 cortes cortos para podar con mayor facilidad.

FR Sécateur à 3 positions. Lame supérieure: acier haut pourcentage de carbone, avec du téflon antidérapant. Lame inférieure: Acier au carbone, poignées aluminium avec traitement TPR antidérapant. Capacité de coupes courtes pour tailler plus facilement.

EN Ratchet pruning shears. Upper blade: High carbon steel blade, non stick teflon coated. Lower blade: Middle carbon steel blade. Handle: Aluminium handles, non-slip TPR grip, cutting. Ability: 20 mm. Design: 3 short cuts for easy pruning.

IT Forbice a cricchetto a 3 posizioni. Lama superiore in acciaio ad alta percentuale di carbonio, in bagno di teflon antiscivolo. Lama inferiore in acciaio al carbonio. Manici in alluminio in bagno di TPR antiscivolo. Capacità di taglio: 20 mm. Meccanismo a tripla azione per potature più facili.

PT Tesouras de catraca 3 cortes. Lâmina superior: de aço carbono, banhado de teflon anti-deslizante. Lâmina inferior: de aço carbono. Pegas em alumínio, aperto antiderrapante TPR. Capacidade de corte: 20 mm. Desenho: 3 cortes curtos para facilitar a poda.

Ref	📦	📦	📦	📦
9001 3141	1	10	15,50	✓

Ref	✍	📦	📦
9001 314101	Muelle recambio / Ressort de rechange Spare spring / Molla ricambio / Mola de reposição	5	0,99
9001 314102	Tornillo tijeras / Vis de rechange Spare screw / Vite forbice / Parafuso tesouras	1	1,56
9001 314103	Tuerca recambio / Ecrous de rechange Spare nut / Dado forbice / Porca de substituição	1	0,52



TIJERAS DE RECOLECCIÓN 210 mm MANGO ACERO / CISEAUX DE RÉCOLTE 210 mm EN ACIER AU CARBONE  
210 mm LONG BLADE FRUIT PRUNER, STEEL HANDLE / FORBICE DA POTATURA 210 mm, MANICO D'ACCIAIO / TESOURAS DE PODAR 210 mm PEGAS EM AÇO



Ref	↔	📦	📦	📦	📦
9001 8080	210 mm	1	10	8,74	✓



Ref	🔧	📦	📦
9001 808001	Muelle recambio / Ressort de rechange Spare spring / Molla ricambio / Mola de reposição	5	0,99

TIJERAS DE RECOLECCIÓN 215 mm (8 ½") / SÉCATEUR MANCHE ROTATIF 215 mm (8 ½") / HEAVY DUTY BYPASS PRUNING SHEARS 215 mm (8 ½")  
FORBICE DA POTATURA DA 215 mm (8 ½") CON MANICO GIREVOLE / TESOURAS DE PODAR 215 mm (8 ½")



ES Tijeras mango rotativo 215 mm (8½"), minimiza el esfuerzo y la fatiga, especialmente en uso frecuente, hojas en acero, bañado en teflón, mango de aluminio ergonómico.

FR Sécateur manche rotatif 215 mm (8½"), réduit l'effort et la fatigue lors d'utilisations prolongées, lame acier et bain téflon, poignées aluminium ergonomiques.

EN Heavy duty bypass pruning shears 215 mm (8½"), auto-rotating handle (minimizes strain and fatigue), carbon steel blades, non-stick teflon coated, aluminium handle, PP and soft rubber (TPR) grip.

IT Forbice con manico girevole da 215 mm (8½"). Riduce lo sforzo e la fatica in caso di utilizzo prolungato. Lama d'acciaio in bagno di teflon. Manico ergonomico in alluminio.

PT Tesouras com cabo giratório 215 mm (8½"), minimiza o esforço e a fadiga, especialmente em uso frequente, lâminas em aço, banhado em teflon, pega ergonômica de alumínio.

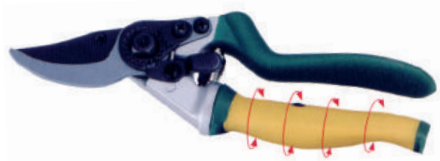

Mango rotativo  
Auto-rotating handle

Ref	📦	📦	📦	📦
9001 3102	1	10	14,60	✓

TIJERAS CORTACÉSPED PROFESIONAL 340 mm (13½") / CISEAUX À GAZON PROFESSIONNELS 340 mm (13½")  
STAINLESS STEEL GRASS SHEARS 340 mm (13½") / FORBICE DECESPUGLIATRICE DA 340 mm (13½") / TESOURA CORTA-SEBES PROFISSIONAL 340 mm (13½")



ES Tijeras cortacésped profesional 340 mm (13½"), corte regulable a 180°, 6 posiciones de corte.

FR Ciseaux à gazon professionnels 340 mm (13½"), coupe réglable a 180°, 6 positions de coupe.

EN Stainless steel grass shears 340 mm (13½"), 180° swivel blades, 6 cutting positions.

IT Forbice per potatura da 340 mm (13½"). Taglio regolabile a 180°, 6 posizioni di taglio.

PT Tesouras corta-sebes profissional 340 mm (13½"), corte regulável a 180°, 6 posições de corte.



Ref	📦	📦	📦	📦
9001 3112	1	10	14,92	✓

CIZALLA CORTA-SETOS PROFESIONAL / CISAILLES PROFESSIONNELLES / PROFESSIONAL HEDGE SHEARS  
FORBICE TAGLIASIEPI PROFESSIONALE / CICALHA PARA SEBES PROFISSIONAL



ES Cizalla corta-setos profesional, cuchillas autoafilables en acero forjado, cuchillas de 22 cm de longitud, regulación de tensión de cuchillas.

FR Cisailles professionnelles, lame auto aiguisables en acier forgé, lames de 22 cm, réglage de tension des lames.

EN Professional hedge shears, forged steel sharp blades, 22 cm, length blades, blade pressure regulation.

IT Forbice tagliasiepi professionale, lame autoaffilanti in acciaio forgiato, lame di 22 cm di lunghezza, regolazione tensione delle lame.

PT Cicalha profissional para sebes, lâminas afiáveis em aço forjado de 22 cm de comprimento, regulação da pressão da lâmina.



Ref	📦	📦	📦	📦
9001 2401	1	12	27,07	✓



SIERRA DE PODA PROFESIONAL 500 mm / SCIE A TAILLE PROFESSIONNELLE 500 mm / PRUNING SAW 500 mm  
SEGA PER POTATURA PROFESSIONALE 500 mm / SERRA DE PODAR PROFISSIONAL 500 mm



ES Sierra de poda profesional 500 mm, hoja de 300 mm con dientes triangulares, acero con alto contenido en carbono, empuñadura ergonómica y antideslizante, funda de protección.

FR Scie à taille professionnelle 500 mm, lame 300 mm dents triangulaires, acier a haute teneur en carbone, poignées ergonomiques antidérapantes, étui de protection.

EN Pruning saw 500 mm, 300 mm blade with triangular teeth, high carbon steel blade, ABS plastic handle, non-slip grip, blister carded.

IT Sega per potatura professionale. Lama da 300 mm, con denti triangolari. Acciaio ad alto contenuto di carbonio. Impugnatura ergonomica e antiscivolo. Fondina di protezione.

PT Serra de podar profissional 500 mm. Lâmina de 300 mm com dentes triangulares, aço com alto conteúdo em carbono, cabo ergonômico e antideslizante, invólucro de proteção.

Ref				
9001 9575	1	10	24,97	✓

SIERRA DE PODA PLEGABLE PROFESIONAL 170 mm / SCIE À TAILLE PROFESSIONNELLE PLIABLE 170 mm / FOLDING PRUNING SAW 170 mm  
SEGA PIEGHEVOLE PER POTATURA LAMA DA 170 mm / SERRA DE PODAR DOBRÁVEL PROFISSIONAL 170 mm



ES Sierra de poda plegable profesional (170 mm), hoja de 170 mm con dientes triangulares, acero con alto contenido en carbono, empuñadura ergonómica y antideslizante, dispositivo de bloqueo en la hoja.

FR Scie à taille professionnelle pliable (170 mm), lame 170 mm dents triangulaires, acier a haute teneur en carbone, poignées ergonomiques antidérapantes, dispositif de blocage de la lame.

EN Folding pruning saw (170 mm), 170 mm blade with triangular teeth, high carbon steel blade. ABS plastic handle, non-slip grip, handle can be locked when retracted.

IT Sega pieghevole per potatura. Lama da 170 mm, con denti triangolari. Acciaio ad alto contenuto di carbonio. Impugnatura ergonomica e antiscivolo. Dispositivo di bloccaggio della lama.

PT Serra de podar dobrável profissional (170 mm). Lâmina de 170 mm com dentes triangulares, aço com alto conteúdo em carbono, cabo ergonômico e anti-deslizante, dispositivo de bloqueio na lâmina.

Ref				
9001 9565	1	10	15,86	✓

NAVAJA PLEGABLE DE INJERTAR / COUPEAU GREFFE PLIABLE / GARDENING KNIFE  
COLTELLINO PIEGHEVOLE PER INNESTI / FACA DOBRÁVEL DE JARDINAGEM



Ref				
9001 0025	1	20	9,05	✓

CUCHILLO DE RECOLECCIÓN CON DEPÓSITO / COUPEAU DE RÉCOLTE AVEC RÉSERVOIR / VEGETABLE/PLANT KNIFE WITH CONTAINER  
TAGLIERINO CON SERBATOIO / FACA DE RECOLEÇÃO COM DEPÓSITO



Ref				
9001 1007	1	10	14,51	✓





**TIJERAS DE PODA PROFESIONAL 510 mm / SÉCCATEUR A TAILLE PROFESSIONNEL 510 mm / BYPASS LOPPER 510 mm  
FORBICE PER POTATURE PROFESSIONALI 510 mm / TESOURAS DE PODAR PROFISSIONAIS 510 mm**



ES Tijeras de poda profesional 510 mm, hoja en acero de filo cóncavo forjado, mangos tubulares de 300 cm en aluminio, empuñadura en plástico antideslizante y amortiguador en goma.

FR Sécateur professionnel 510 mm, lame en acier forgé à bords concaves, manches tubulaires en aluminium de 300 cm, poignée en plastique antidérapante et amortis en caoutchouc.

EN 510mm professional pruning shears with steel blades, forged concave edges, 300cm aluminium round handle, slip-resistant plastic handle grip, and rubber buffers.

IT Forbice da potatura professionale 510mm con lama in acciaio concava e forgiata, manici rotonde di 300cm in alluminio con impugnatura antiscivolo in plastica e dado in gomma.

PT Tesouras de poda profissional 510 mm, lâmina de aço de fio côncavo, braços tubulares de alumínio de 300 cm, punho plástico antiderrapante e amortecedor de borracha.

Ref	↔	📦	📦	📦	📦
<b>9001 1105</b>	51 cm	1	12	<b>38,01</b>	✓

Ref	✎	📦	📦
<b>9001 110501</b>	Tope de goma / Joint sécateur / Rubber top Tappo di gomma / Topo de borracha	1	<b>1,50</b>
<b>9001 110502</b>	Tornillo, tuerca y arandela / Vis, écrou et rondelle Screw, nut and washer / Vite, dado e rondella / Parafuso, porca e arruela	1	<b>4,80</b>
<b>9001 110503</b>	Tornillo del mango / Boulon / Screw Vite / Tornillo del mango	1	<b>1,80</b>
<b>9001 110504</b>	Tuerca del mango / Ecrou / Nut Dado / Tuerca del mango	1	<b>1,10</b>

**TIJERAS PODA ALUMINIO (Ø40 mm) 75 cm / CISEAUX ÉLAGAGE ALUMINIUM (Ø40 mm) 75 cm / ALUMINIUM PRUNING SHEARS (Ø40 mm) 75 cm  
FORBICI DA POTATURA IN ALLUMINIO (Ø40 mm) 75 cm / TESOURAS DE PODAR DE ALUMÍNIO (Ø40 mm) 75 cm**



Ref	↔	∅	📦	📦	📦
<b>9001 3115</b>	75 cm	40 mm	1	6	<b>33,07</b>

Ref	✎	📦	📦
<b>9001311510</b>	Cabezal completo tijera poda / Tete de coupe complete ciseau d'élagage Complete spare blade for shears / Pinza potatrice Cabeça completa tesoura podar	1	<b>18,91</b>

**TIJERAS DE PODA TELESCÓPICA 64-98 cm (25"-38") / SÉCCATEUR TELESCOPIQUE 64-98 cm (25"-38") / RATCHET BYPASS TELESCOPIC SHEARS 64-98 cm (25"-38")  
FORBICE PER POTATURE TELESCOPICA 64-98 cm (25"- 38") / TESOURA DE PODAR TELESCÓPICA 64-98 cm (25" - 38")**

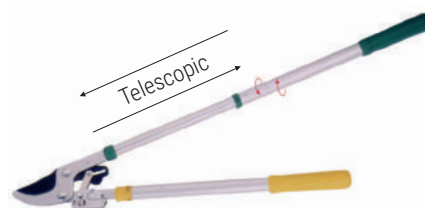
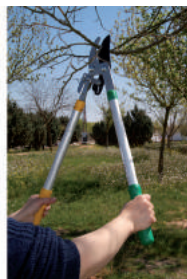

ES Tijeras de poda telescópica (65 - 970 mm). Cuchillas fabricadas en acero al carbono, bañadas en teflón. Medida de la cuchilla: 12 cm x 5,0 mm. Capacidad de corte: 45 mm. Mangos telescópicos fabricados en aluminio con confortables grips.

FR Sécateur telescopique (65 - 970 mm). Lames en acier carbone, revêtues de téflon. Dimensions de la lame: 12 cm x 5,0 mm. Capacité de coupe: 45 mm. Poignées télescopiques en aluminium, prise en main confortable.

EN Ratchet bypass telescopic shears (65 - 970 mm). Upper blade: high carbon steel blade, non-stick teflon coated. Lower blade: middle carbon steel blade, chrome plating. Blade size: 12 cm x 5,0 mm. Handle: aluminium telescopic handles, comfortable grips.

IT Forbice per potatura telescopica (65 - 970 mm). Lama di taglio in acciaio al carbonio, in bagno di teflon. Misura della lama 12 cm x 5,0 mm. Capacità di taglio: 45mm. Manici telescopici in alluminio con maniglie a presa confortevole.

PT Tesouras de podar telescópicas (65 - 970 mm). Lâmina: aço de carbono, revestidas de teflon. Tamanho da lâmina: 12 cm x 5,0 mm. Corte: 45 mm. Pegas telescópicas de alumínio com apertos confortáveis.

Ref	↔	📦	📦	📦	📦
<b>9001 3110</b>	64 - 98 cm	1	12	<b>45,37</b>	✓



TIJERAS DE PODA TIPO YUNQUE DE 790 mm / CISEAUX D'ÉLAGAGE TYPE ENCLUME DE 790 mm / BYPASS BONE - JOINT LOPPER 790 mm  
FORBICE DA POTATURA DA 790 mm, TIPO INCUDINE / TESOURAS DE PODAR 790 mm



Nuevo diseño de unión para ahorrar esfuerzo.  
Nouvelle conception d'union pour moins d'effort.  
New bone-joint design to save a working effort.  
Nuovo design per il risparmio di fatica.  
Novo desenho de união para menos esforço no trabalho.

ES Tijeras de poda tipo yunque de 790 mm. Cuchilla de acero al carbono con recubrimiento de teflón. Mangos de aluminio. Capacidad de corte: 45 mm

FR Ciseaux d'élagage type enclume de 790 mm. Lame d'acier au carbone avec recouvrement de téflon. Manche d'aluminium. Capacité de coupe: 45 mm

EN Bypass bone-joint lopper Carbon steel with non-stick teflon coated blade. Aluminium handle. Cutting capacity: 45 mm.

IT Forbice da potatura tipo incudine da 790mm. Lama in acciaio al carbonio con copertura in teflon. Manico in alluminio. Capacità di taglio: 45mm

PT Tesouras de podar de 790 mm. Lâminas de aço carbono com revestimento de teflon. Pegas em alumínio. Corte: 45 mm.

Ref	↔	📦	📦	📦	📦
9001 7115	79 cm	1	6	28,91	✓

RECOGEDOR DE LARGO ALCANCE (2.060 mm) / POUR CUEILLETTE LONGUE PORTÉE (2060 mm) / LONG REACH HARVESTER (2060 mm)  
RACCOGLITORE A LUNGO RAGGIO (2060 mm) / COLHEDOR DE LONGO ALCANCE (2060 mm)



↑  
Telescópico

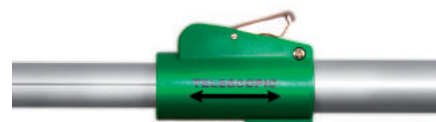

Ref	↔	📦	📦	📦
9001 3140	206 cm	1	8	56,06



PODADORA DE LARGO ALCANCE / TAILLE HAIES TÉLESCOPIQUE LONG / LONG REACH PRUNER  
POTATRICE AD AMPIO RAGGIO / PODADOR DE LONGO ALCANCE

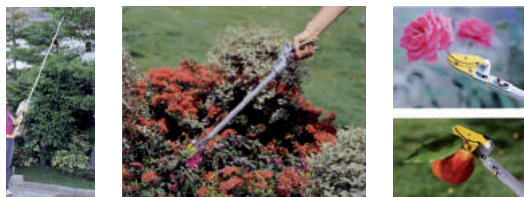

- 1  
ES - Cuchilla de acero al carbono SK-5, bañadas en teflón antideslizante.  
FR - Lame acier au carbone SK-5, avec bain téflon antidérapant.  
EN - High carbon SK-5, steel blade with non-stick teflon coat.  
IT - Lama in acciaio al carbonio in bagno di teflon anti-scivolo.  
PT - Lâmina de aço carbono SK-5, cobertas de teflon anti-deslizante.
- 2  
ES - Dispositivo "corta y agarra".  
FR - Dispositif "coupe et attrape".  
EN - Removable "cut and hold feature".  
IT - Dispositivo "taglia e mantieni".  
PT - Dispositivo "corte e segura".

- 3  
ES - Fabricado de aluminio de alta resistencia, para cortar y podar en sitios de difícil acceso.  
FR - Conception en aluminium de haute résistance, pour couper et tailler dans des lieux d'accès difficile.  
EN - High strength aluminum construction for pruning, cutting and picking in hard to reach areas.  
IT - Fabbriato in alluminio ad alta resistenza, per tagliare e potare in posti difficilmente accessibili.  
PT - Fabricado em alumínio de alta resistência, para cortar e podar em sitios de difícil acesso.

- 4  
ES - Mango de espuma.  
FR - Manche éponge.  
EN - Foam grip.  
IT - Impugnatura in spugna.  
PT - Pega em espuma.
- 5  
ES - Cierre de seguridad.  
FR - Fermeture sécurisée.  
EN - Safety lock.  
IT - Chiusura di sicurezza.  
PT - Fecho de segurança.
- 6  
ES - Mango antideslizante muy suave.  
FR - Manche antidérapant très lisse.  
EN - Soft antislip grip.  
IT - Confortevole impugnatura antiscivolo.  
PT - Pegas anti-deslizante muito suave.

Ref	↔	📦	📦	📦
9001 3146	630 mm	1	30,58	✓
9001 3147	1230 mm	1	35,57	✓
9001 3148	1530 mm	1	38,19	✓
9001 3149	2030 mm	1	41,99	✓

RECAMBIO CABEZAL COMPLETO PODADORA L. ALCANCE / PIECE DE RECHANGE TETE TAILLE HAIE TELESCOPIQUE LONG  
SPARE COMPLETE HEAD PRUNING SHEARS LONG RANGE / RICAMBIO COMPLETO COPERTURA PER MOTOSEGA  
SUBSTITUIÇÃO COMPLETA CABEÇA TESOURA DE PODAR LONGO ALCANCE



- ES - Cuchilla de acero al carbono SK-5, bañadas en teflón antideslizante.  
FR - Lame acier au carbone SK-5, avec bain téflon antidérapant.  
EN - High carbon SK-5, steel blade with non-stick teflon coat.  
IT - Lama in acciaio al carbonio in bagno di teflon anti-scivolo.  
PT - Lâmina de aço carbono SK-5, cobertas de teflon anti-deslizante.

Ref	📦	📦
9001 314605	1	12,25

RECAMBIO MANGO COMPLETO PODADORA L. ALCANCE / PIECE DE RECHANGE MANCHE COMPLET TAILLE HAIE TELESCOPIQUE LONG  
SPARE COMPLETE HANDLE PRUNING SHEARS LONG RANGE / RICAMBIO COMPLETO IMPUGNATURA PER MOTOSEGA  
SUBSTITUIÇÃO COMPLETA CABO TESOURA DE PODAR LONGO ALCANCE



- 1  
ES - Cierre de seguridad.  
FR - Fermeture sécurisée.  
EN - Safety lock.  
IT - Chiusura di sicurezza.  
PT - Fecho de segurança.
- 2  
ES - Mango antideslizante muy suave.  
FR - Manche antidérapant très lisse.  
EN - Soft antislip grip.  
IT - Confortevole impugnatura antiscivolo.  
PT - Pegas anti-deslizante muito suave.

Ref	📦	📦
9001 314606	1	13,00



ESCOBA PLEGABLE METAL 15 PÚAS / RAMASSE-FEUILLE PLIABLE METAL 15 DENTS / METAL FOLDING RAKE 15 TEETH  
 SCOPA METALLICA REGOLABILE 15 DENTI / VASSOURA METÁLICA DOBRÁVEL 15 PICOS



Ref					
9001 5121	15	1200 mm	1	12	11,80

RASTRILLO JARDÍN / RÂTEAU DE JARDIN / GARDEN RAKE / RASTRELLIO GIARDINO / ANCINHO DE JARDIM



Ref					
9001 5110	10	250 x 90 mm	1	6	11,88
9001 5112	12	300 x 90 mm	1	6	12,27
9001 5114	14	350 x 90 mm	1	6	12,67
9001 5116	16	400 x 90 mm	1	6	13,10
9001 5118	18	460 x 90 mm	1	6	13,50

MANGO MADERA RASTRILLO / MANCHE DE RÂTEAU EN BOIS / WOODEN HANDLE FOR RAKE  
 MANICO IN LEGNO PER RASTRELLIO / CABO DE MADEIRA ANCINHO



Ref				
0951 9452	1200 mm	29 mm	1	4,07
0951 9454	1400 mm	29 mm	1	4,89

ARTÍCULOS DE TUTORAR / ACCESSOIRES TUTEURS / SUPPORT ACCESSORIES / ACCESSORI / ACESSÓRIOS DE SUPORTE

GOMAS DE ANCLA / ATTACHES ÉLASTIQUES / ANCHOR RUBBER / ANELLI IN GOMMA / BORRACHAS DE ANCORAGEM



Ref				
9001 0021	nº 3	700	14.000	0,02
9001 0012	nº 5	5000	10.000	0,02
9001 0018	nº 8	300	6.000	0,04

TENSOR DE CARRACA REFORZADO / TENDEUR A CLIQUET / WIRE TAUTENER / TIRANTE A CRICCHETTO / TENSOR DE CATRACA REFORÇADO



Ref			
9001 0011	1	225	0,77



MANGUERA PVC MONOCAPA CRISTAL / TUYAU PVC CLAIR / SINGLE LAYER PVC CLEAR HOSE  
 TUBO IN PVC TRASPARENTE / MANGUEIRA PVC MONOCAMADA CRISTA

PVC



Ref	↔	∅	📏	📦	📦	📦
9001 4500	100 m	4 x 6 mm	1	90	18,46	
9001 4501	100 m	5 x 8 mm	1	56	34,67	
9001 4502	100 m	6 x 9 mm	1	44	34,63	
9001 4503	100 m	7 x 10 mm	1	40	42,23	
9001 4504	100 m	8 x 12 mm	1	25	54,48	
9001 4505	50 m	10 x 14 mm	1	34	30,83	
9001 4506	50 m	12 x 17 mm	1	26	49,21	

Ref	↔	∅	📏	📦	📦	📦
9001 4507	50 m	14 x 19 mm	1	22	58,71	
9001 4508	50 m	16 x 22 mm	1	16	92,49	
9001 4509	50 m	18 x 24 mm	1	12	85,02	
9001 4510	50 m	20 x 26 mm	1	10	103,07	
9001 4511	50 m	25 x 31 mm	1	8	110,85	
9001 4512	25 m	30 x 38 mm	1	10	88,56	

MANGUERA PVC CRISTAL CON REFUERZO / TUYAU PVC TRESSÉ REFORCÉ / 3 LAYERS PVC TRANSP. REINFORCED HOSE  
 TUBO IN PVC RIFORZATO / MANGUEIRA PVC CRISTAL REFORÇADA

PVC



Ref	↔	∅	📏	📦	📦	📦
9001 4600	100 m	6 x 12 mm	1	30	80,79	
9001 4601	100 m	8 x 14 mm	1	18	93,87	
9001 4602	50 m	10 x 16 mm	1	30	55,66	
9001 4603	50 m	12 x 18 mm	1	20	70,81	
9001 4604	50 m	15 x 21 mm	1	16	82,85	
9001 4605	50 m	19 x 26 mm	1	10	107,07	
9001 4606	50 m	25 x 33 mm	1	6	177,67	
9001 4607	25 m	30 x 38 mm	1	8	97,17	

3 CAPAS CON ACCESORIOS / 3 COUCHES AVEC ACCESSOIRES / 3 LAYERS WITH ACCESSORIES  
 3 STRATI ANTITORSIONE / 3 CAMADAS COM ACCESSÓRIOS



Ref	↔	∅	📏	📦	📦	📦
9001 4100	15 m	5/8" (15 mm)	1	86	14,05	
9001 4101	20 m	5/8" (15 mm)	1	66	17,81	

3 CAPAS TRANSLÚCIDAS / 3 COUCHES TRANSLUCIDE / 3 LAYER TRANSLUCENT  
 3 STRATI TRANS. / 3 CAMADAS TRANSLÚCIDA

FLEXOLÁTEX



Ref	↔	∅	📏	📦	📦	📦
9001 4251	25 m	5/8" (15 mm)	1	43,96		
9001 4252	50 m	5/8" (15 mm)	1	87,29		
9001 4253	25 m	3/4" (19 mm)	1	65,46		
9001 4254	50m	3/4" (19 mm)	1	130,50		
9001 4255	25 m	1" (25 mm)	1	81,07		





MANGUERA PVC MOD. STORM 3 CAPAS TRENZADAS / TUYAU PVC MOD. STORM 3 COUCHES TRESSÉ / PVC HOSE "STORM" 3 LAYERS (BRAIDED)  
TUBO PVC "MOD. STORM" 3 STRATI INTRECCIATI / MANGUEIRA PVC MOD. STORM 3 CAMADAS TRANÇADA



Ref	↔	∅	📦	📊
9001 4310	15 m	15	1	16,81
9001 4311	25 m	15	1	27,24
9001 4312	50 m	15	1	53,30
9001 4313	25 m	19	1	40,86
9001 4314	50 m	19	1	81,24
9001 4315	25 m	25	1	60,93
9001 4316	50 m	25	1	120,22

MANGUERA PVC MOD. THUNDER 3C TRICOTADA / TUYAU PVC MOD. THUNDER 3 COUCHES TRICOTÉ / PVC HOSE "THUNDER" 3 LAYERS (KNITTED)  
TUBO PVC "MOD. THUNDER" 3 STRATI A MAGLIA / MANGUEIRA PVC MOD. THUNDER 3 CAMADAS TRICOTADA



Ref	↔	∅	📦	📊
9001 4320	15 m	15	1	22,31
9001 4321	25 m	15	1	36,04
9001 4322	50 m	15	1	70,77
9001 4323	25 m	19	1	57,67
9001 4324	50 m	19	1	114,45
9001 4325	25 m	25	1	81,90
9001 4326	50 m	25	1	162,08

KIT MANGUERA 10 M X Ø 9,5 mm CON ACCESORIOS Y COLGADOR / KIT TUYAU 10 M X Ø 9,5 mm AVEC ACCESSOIRES ET COLGADOR  
HOSE KIT WITH ACCESSORIES AND HANGER 10 M Ø 9,5 mm / KIT TUBO 10 M Ø 9,5 mm CON ACCESSORI E UGELLO  
KIT MANGUEIRA 10 M X Ø 9,5 mm COM ACESSÓRIOS E GANCHO

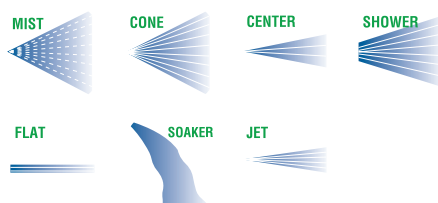

ES Pistola de riego con 7 posiciones. Ligero y portátil.  
FR Pistolet d'irrigation avec 7 positions. Léger et portable.  
EN Watering gun with 7 positions. Lightweight and portable.  
IT Pistola per irrigazione a 7 getti. Leggero e portatile.  
PT Pistola de regar com 7 posições. Leve e portátil.

Ref	↔	∅	📦	📊
9001 4110	10 m	9,5 mm	1	4

KIT DE NEBULIZACIÓN 6 METROS / KIT PULVERISATEUR 6 MÈTRES / 6 METERS LONG FOGGING KIT  
KIT NEBULIZZATORE DA 6 METRI / KIT DE PULVERIZAÇÃO 6 METROS

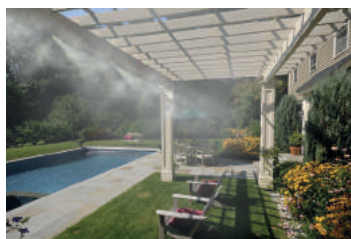

ES Enfriador sin necesidad de electricidad. Uso directo con agua del grifo.  
FR Refroidisseur sans avoir besoin d'électricité. Utilisation directe avec eau du robinet.  
EN Cooler with no need of electricity. Direct use with tap water.  
IT Processo di funzionamento senza necessità di elettricità. Uso diretto con l'acqua del rubinetto.  
PT Refrigerador sem eletricidade. Uso direto com água da torneira.

Ref	↔	📦	📊	📌
9001 4120	6 m	1	6	32,58

SOPORTE PARED PARA MANGUERA / SUPPORT PAROI POUR TUYAU  
HOSE HANGER / SUPPORTO A MURO PER TUBI FLESSIBILI  
SUPORTE DE PAREDE PARA MANGUEIRA



Ref			
9001 5101	1	12	5,20

SOPORTE PARED PARA MANGUERA CON CAJÓN  
SUPPORT PAROI POUR TUYAU AVEC TIROIR  
HOSE HANGER WITHN DRAWER  
SUPPORTO A MURO PER TUBI FLESSIBILI. CON CASSETTO  
SUPORTE DE PAREDE PARA MANGUEIRA COM CAIXA



Ref			
9001 5102	1	4	19,34

ENROLLADOR MANGUERA / ENROULEUR TUYAU / HOSE REEL  
AVVOLGITUBO / CARRETEL PARA MANGUEIRA



Ref		
9001 5103	1	40,77

ENROLLADOR MANGUERA CON RUEDAS / ENROULEUR TUYAU AVEC ROUES  
STRONG AND PORTABLE HOSE REEL / AVVOLGITUBO CON RUOTE  
CARRETEL PARA MANGUEIRA COM RODAS



Ref		
9001 5104	1	58,81

ENROLLADOR DE MANGUERA PARA JARDÍN / ENROULEUR TUYAU D'ARROSAGE POUR JARDIN / AUTOMATIC GARDEN HOSE REEL  
AVVOLGITUBO DARDENA CON TUBO / ENROLADOR DE MANGUERA DE JARDIM



**Longitud/Hose length: 20 metros**

**Ø De la manguera/Ø Hose: 15mm**

**Longitud de manguera de conexión/Connection hose length: 2 metros**

**Presión de trabajo/Working pressure: 8 bar**



ES Enrollador con recogida automática de la manguera, soporte de PP con un anclaje y un soporte de pared que puede girar hasta 180°. Dispone de un mecanismo de retracción ordenada de la manguera. La manguera puede inmovilizarse en zonas predefinidas.

FR Enrouleur de tuyau avec retour automatique du tuyau, support en PP avec ancrage et support mural pouvant pivoter jusqu'à 180°. Il a un mécanisme de rétraction ordonnée pour le tuyau. Le tuyau peut être immobilisé dans des zones prédéfinies.

EN An automatic wind up function is integrated in this hose reel. The PP hose box can be swivelled by 180° by using the provided wall bracket. An integrated retraction mechanism works automatically to wind the hose in a controlled manner. The hose can be locked at preset positions.

IT Avvolgitubo in PP che comprende un sistema di riavvolgimento automatico e una staffa di montaggio a parete per una rotazione di 180°. Questo sistema può riavvolgere il tubo flessibile in modo ordinato. Il tubo può essere bloccato in posizioni predefinite.

PT Enrolador com recolha automática da mangueira, suporte de PP, com uma bucha e um suporte de parede que pode girar até 180°. Dispõe de um mecanismo de retração ordenada da mangueira. A mangueira pode-se imobilizar em zonas pré-defenidas.

ES Racores de conexión y boquilla de riego incluidos. Manguera reforzada de PVC.

FR Raccords de connexion et buse d'arrosage inclus. Tuyau renforcé en PVC.

EN The hose connectors and a spray nozzle are included. Reinforced PVC hose.

IT Connettori e un ugello spray per il tubo sono inclusi. Tubo flessibile rinforzato in PVC.

PT Racores de ligação e boquilla de rega incluídos. Mangueira reforçada de PVC.

Ref	Ø	↔			
9001 5105	9,5X15 mm	20 m	8 bar	1	85,15



ROLLO TUBO ESPIRAL ASPIRACIÓN AMARILLO / ROULEAU TUYAU SPIRALE ASPIRATION JAUNE / YELLOW SUCTION KNIK-FREE TUBE ROLL  
 ROLOTO TUBO SPIRALATO GIALLO / ROLO TUBO ESPIRAL ASPIRAÇÃO AMARELO



APTO PARA  
USO ALIMENTARIO



CE 1935/2004, UE 10/2011

ISO 3994

- ES Utilizado para ventilación y aspiración. Excelente resistencia al desgaste por su espiral rígida interna. Gran flexibilidad y resistencia al impacto por el recubrimiento de PVC plastificado. Temperatura de aplicación -10/+55°C y para bebida y alimentario -10°/+40°C.
- FR Utilisé pour la ventilation et l'aspiration. Excellente résistance à l'usure grâce à sa spirale interne rigide. Grande flexibilité et résistance à l'impact grâce à son revêtement en PVC plastifié. Température d'application -10/+55°C et pour les boissons et la nourriture -10°/+40°C.
- EN Used for the suction & ventilation. It has an excellent wear resistance because of its internal rigid spiral. With a great flexibility and sock resistant due to the plasticised PVC coating. Application temperature: -10/+55°C for alimentary and beverage use.
- IT Usato per aspirazione e ventilazione. Eccellente resistenza all'usura dalla sua spirale rigida interna. Ottima flessibilità e resistente agli urti dal rivestimento in PVC plastificato. Temperatura di applicazione: -10/+55°C per all'uso alimentare e bevanda.
- PT Utilizado para ventilação e aspiração. Excelente resistência ao desgaste por a sua espiral rígida interna. Grande flexibilidade e restencia ao impacto por o recubrimiento de PVC plastificado. Temperatura de aplicação -10/+55°C y para bebida e alimentario -10°/+40°C.

Ref	Ø	↔	📦	📊
9001 4420	20 mm	25 m	1	57,88
9001 4421	25 mm	25 m	1	74,26
9001 4422	30 mm	25 m	1	87,36
9001 4424	35 mm	25 m	1	110,29
9001 4425	40 mm	25 m	1	132,13
9001 4434	42 mm	25 m	1	147,42
9001 4426	45 mm	25 m	1	158,34
9001 4427	50 mm	25 m	1	184,55
9001 4428	60 mm	25 m	1	221,68
9001 4429	70 mm	25 m	1	287,20
9001 4430	75 mm	25 m	1	326,51
9001 4431	80 mm	25 m	1	378,92
9001 4432	90 mm	25 m	1	431,34
9001 4433	100 mm	25 m	1	483,76

ROLLO TUBERÍA HIDRO GRIS CERTIFICADA / ROULEAU TUYAU HYDRO CERTIFIE GRIS / CERTIFIED GREY WATER PIPE ROLL  
 ROLOTO TUBO PER ACQUA GRIGIO / ROLO TUBERIA HIDRO CINZENTA CERTIFICADA



CE ISO 3994 (tipo/type 2)

- ES Excelente resistencia a la compresión y gran compatibilidad de unión con los sistemas de tuberías de PVC. Espiral PVC rígido y recubrimiento de PVC plastificado. Para el suministro y distribución de aguas en piscinas y jacuzzis. Para la reparación de redes de evacuación en PVC-U del tipo serie B de la norma EN 1329.
- FR Excellente résistance à la compression et bonne compatibilité pour se raccorder aux systèmes de tuyaux en PVC. Spirale PVC rigide et revêtement en PVC plastifié. Pour la fourniture et la distribution de l'eau dans les piscines et les jacuzzis. Pour la réparation des réseaux d'évacuation en PVC-U du type série B de la norme EN 1329.
- EN Having excellent compressive strength and high joint compatibility with the PVC piping systems. With a PVC rigid spiral and plasticised PVC coating. It is used for the supply and distribution of water into pools and spas, in addition to the repair of PVC-U evacuation network, with B-Series type of the EN1329 regulation.
- IT Eccellente resistenza alla compressione e compatibilità dell'unione con sistemi con tubazioni Spirale rigida in PVC e rivestimento in PVC plastificato. Utilizzato per la fornitura e distribuzione delle acque nella piscine e vasce idromassaggio. Inoltre, è utilizzato per la riparazione di reti di evacuazione in PVC-U di tipo serie B della norma EN1329.
- PT Excelente resistência a compresão e grande compatibilidade de uniao com os sistemas de tuberías de PVC. Espiral PVC rígido e recubrimiento de PVC plastificado. Para o fornecimento e distribuição de águas em piscinas e jacuzzis. Para a reparação de redes de evacuação em PVC-U do tipo serie B da norma EN 1329.

Ref	Ø	↔	📦	📊
9001 4471	20 mm	25 m	5 bar	1 43,68
9001 4472	25 mm	25 m	5 bar	1 66,61
9001 4473	32 mm	25 m	5 bar	1 85,18
9001 4474	40 mm	25 m	5 bar	1 111,75
9001 4475	50 mm	25 m	5 bar	1 181,27





ASPERSOR SECTORIAL DE PLÁSTICO / PULVERISATEUR SECTORIEL EN PLASTIQUE / PLASTIC IMPULSE SPRINKLER  
IRRIGATORE SETTORIALE IN PLASTICA / ASPERSOR SETORIAL DE PLÁSTICO

FLOWER  
WATERING



ES Posibilidad de ajuste de vuelta.  
FR Possibilité de réglage.  
EN Adjusts from full to part circle.  
IT Gittata irrigatore regolabile.  
PT Possibilidade de ajustar as voltas.

- 1/4 de vuelta / de tour / circle / di giro / de volta
- 1/2 vuelta / tour / circle / giro / volta
- 3/4 de vuelta / de tour / circle / di giro / de volta
- Vuelta entera / Tour complet / Full Circle  
Settore completo / Volta completa

Ref				
9001 4003	1	12	7,23	✓

ASPERSOR SECTORIAL DE METAL / PULVERISATEUR SECTORIEL EN METAL / BRASS IMPULSE SPRINKLER  
IRRIGATORE SETTORIALE IN METALLO / ASPERSOR SETORIAL DE METAL

FLOWER  
WATERING



ES Posibilidad de ajuste de vuelta.  
FR Possibilité de réglage.  
EN Adjusts from full to part circle.  
IT Gittata irrigatore regolabile.  
PT Possibilidade de ajustar as voltas.

- 1/4 de vuelta / de tour / circle / di giro / de volta
- 1/2 vuelta / tour / circle / giro / volta
- 3/4 de vuelta / de tour / circle / di giro / de volta
- Vuelta entera / Tour complet / Full Circle  
Settore completo / Volta completa

Ref				
9001 4002	1	12	26,25	✓

ASPERSOR ROTATORIO  
PULVERISATEUR ROTATOIRE  
GEAR DRIVE SPRINKLER WITH SPIKE  
POLVERIZZATORE ROTANTE  
ASPERSOR ROTATIVO

FLOWER  
WATERING



- 360° ← antigo
- 360° ← antiretour
- 360° ← part-circle
- 360° ← settore
- 360° ← anti-rotação

Ângulo de riego.  
Angle d'arrosage.  
Angle coverage.  
Angolo copertura.  
Ângulo de cobertura.



ASPERSOR ROTATORIO CON TRÍPODE TELESCÓPICO  
PULVERISATEUR AVEC TRÉPIED TÉLÉSCOPIQUE  
GEAR DRIVE SPRINKLER WITH TELESCOPIC TRIPOD  
IRRIGATORE A CON TREPPIDE TELESCOPICO  
ASPERSOR ROTATIVO COM TRIPÉ TELESCÓPICO



Ref			
9001 4035	1		50,86

TORRETA ASPERSOR 5 POSICIONES / EMBOUT PULVERISATEUR 5 POSITIONS / PLASTIC 5 PATTERN TURRET SPRINKLER  
TORRETTA D'IRRIGAZIONE A 5 POSIZIONI / TORRE ASPERSOR 5 POSIÇÕES

FLOWER  
WATERING



Ref				
9001 4004	1	12	4,66	✓



ASPERSOR OSCILANTE 16 CHORROS / PULVERISATEUR OSCILLANT / 16 JET OSCILLATING SPRINKLER  
IRRIGATORE OSCILLANTE A 16 UGELLI / ASPERSOR OSCILANTE 16 JATOS



ES Tubo flexible irrompible.  
FR Système résistant incassable.  
EN Unbreakable flexible tube.  
IT Tubo flessibile infrangibile.  
PT Tubo flexível inquebrável.

Ref			
9001 4005	1	10	13,23

ASPERSOR OSCILANTE MULTIFUNCIÓN "TURBO" / PULVERISATEUR MULTIFUNCIÓN OSCILLANT "TURBO"  
MULTIFUNCTION "TURBO" OSCILLATING SPRINKLER / IRRIGATORE OSCILLANTE MULTIFUNZIONE "TURBO"  
ASPERSOR OSCILANTE MULTIFUNCIÓNAL "TURBO"

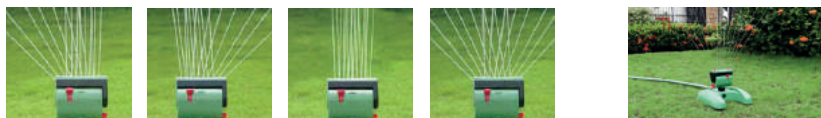

ES Aspersor de 16 posiciones. Cobertura ajustable a lo largo y a lo ancho. Base de plástico resistente. Cobertura hasta 366 m2.  
FR Pulvérisateur 16 positions. Couverture réglable en longueur et en largeur. Base en plastique résistant. Couverture jusqu'à 366m2.  
EN Sprinkler with 16 positions. Lengthwise and widthwise adjustable coverage. Resistant plastic base. Coverage up to 366m2.  
IT Irrigatore a 16 posizioni. Copertura regolabile in larghezza e lunghezza. Base di plastica resistente. Copertura fino a 366m2.  
PT Aspersor de 16 posições. Cobertura ajustável em comprimento e em largura. Base de plástico resistente. Cobertura até 366m2.

Ref			
9001 4009	1	8	27,96

ADAPTADOR PARA ASPERSOR / ADAPTATEUR "WATERDANCING" / "WATERDANCING" ADAPTOR  
ADATTATORE "WATERDANCING" / ADAPTADOR "WATERDANCING"

Ahorra 25% agua en riego  
Up to 25% water saving



ES Riego por impulsos. Mejor absorción de agua para las plantas. Para cualquier aspersor actual. Ahorra más de un 25% de agua.  
FR Meilleure absorption de l'eau pour les plantes. Profitez de l'arrosage dans votre jardin. Fonctionne avec tous les arroseurs. Garde plus de 25% d'eau.  
EN Better water absorption for the plants. Enjoy water dance right in your yard. For any current sprinkler. Up to 25% water saving.  
IT Miglior assorbimento d'acqua per le piante. Godetevi l'effetto "pioggia" nel vostro giardino. Per tutti i tipi d'irrigatore. Risparmia oltre il 25% d'acqua.  
PT Melhor absorção de água para as plantas. Desfrute da dança da água mesmo no seu quintal. Para qualquer aspersor atual. Economia de água até 25%.

Ref				
9001 4032	1	10	9,05	✓

SINCRONIZADOR DE RIEGO MECÁNICO / SYNCRONISEUR D'IRRIGATION MÉCANIQUE / MECHANICAL WATER TIMER  
TIMER MECCANICO PER IRRIGAZIONE / TEMPORIZADOR DE IRRIGAÇÃO MECÂNICO

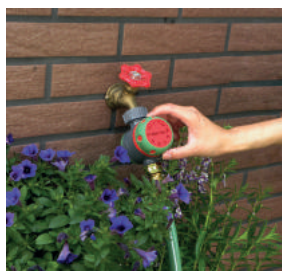

Ref				
9001 4006	1	20	20,25	✓





TEMPORIZADOR DE RIEGO ELECTRÓNICO DIGITAL / TEMPORISATEUR D'ARROSAGE ÉLECTRONIQUE NUMÉRIQUE / ELECTRICAL DIGITAL WATERING TIMER  
 TIMER ELETTRONICO DIGITALE PER IRRIGAZIONE / TEMPORIZADOR DE IRRIGADA ELECTRÓNICO DIGITAL

**4 FUNCTIONS**  
**3/4" - 1"**

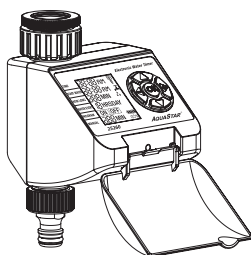

ES Botones de 4 funciones para un manejo fácil. Requeridas dos pilas AA (no incluidas).  
 FR Boutons de 4 fonctions pour un maniement facile. Nécessité de deux piles AA (non incluses).  
 EN 4 function buttons for easy manipulation. Two AA batteries needed (not included).  
 IT Pulsanti a 4 funzioni per un facile utilizzo. Richiede 2 pile AA (non incluse).  
 PT Botões de 4 funções para facilitar a operação. Necessita de duas pilhas AA (não incluídas).

Ref				
9001 4007	1	4	64,59	✓

PISTOLA DE RIEGO 7 POSICIONES / PISTOLET D'IRRIGATION 7 POSITIONS / 7 PATTERN NOZZLE  
 PISTOLA D'IRRIGAZIONE A 7 POSIZIONI / INJETOR DE IRRIGAÇÃO 7 POSIÇÕES

**FLOWER**  
**WATERING**



Ref				
9001 4029	1	12	7,45	✓

PISTOLA METAL 7 POSICIONES GATILLO FRONTAL / PISTOLET MÉTAL POSITIONS DÉCLENCHÉUR FRONTAL / 7 PATTERN FRONT PULL LEVER NOZZLE  
 PISTOLA D'IRRIGAZIONE A 7 POSIZIONI GRILLETTO FRONTALE / INJETOR METÁLICO 7 POSIÇÕES GATILHO FRONTAL

**FLOWER**  
**WATERING**



Ref				
9001 4030	1	12	13,87	✓

PISTOLA DE RIEGO CON CONTROL DE CAUDAL EN EL PULSADOR / PISTOLET D'ARROSAGE AVEC CONTRÔLE DE DÉBIT SUR LE DISTRIBUTEUR  
 PATTERN NOZZLE WITH CAUDAL CONTROL IN THE SWITCH BUTTON / PISTOLA PER IRRIGAZIONE CON CONTROLLO DEL FLUSSO SUL PULSANTE  
 PISTOLA DE REGAR COM CONTROLE DE FLUXO NO BOTÃO



Ref				
9001 4045	1	24	13,24	✓



LANZA RIEGO 66 CM 10 POSICIONES / PISTOLET ARROSAGE 66 CM / 66 CM ADJUSTABLE 10 PATTERN WATER WAND  
LANCIA D'IRRIGAZIONE 66 CM 10 POSIZIONI / LANÇA IRRIGAÇÃO 66 CM 10 POSIÇÕES



Ref				
9001 4031	1	12	15,59	✓

PISTOLA DE RIEGO 4-1/2" / PISTOLET D'IRRIGATION 4-1/2" / 4-1/2" TRIGGER NOZZLE  
PISTOLA D'IRRIGAZIONE 4-1/2" / INJETOR DE IRRIGAÇÃO 4-1/2"



ES Extremo biselado para el acople de accesorios. Palanca de fibra de vidrio reforzada.  
FR Extrémité biseautée permettant d'ajouter des accessoires. Levier en fibre de verre renforcée.  
EN Threaded end for accessory attachment. Fiberglass reinforced lever.  
IT Finale filettato per il fissaggio di accessori. Leva in fibra di vetro rinforzata.  
PT Extremidade roscada para o acessório de fixação. Alavanca de fibra de vidro reforçada.

Ref				
9001 4026	1	24	2,96	✓

BOQUILLA REGULABLE / OUVERTURE RÉGLABLE / TWIST NOZZLE WITH ADAPTOR / LANCIA CON APERTURA REGOLABILE / INJETOR REGULÁVEL



ES El pulverizador se ajusta desde vaporización hasta chorro.  
FR L'embout du tuyau d'arrosage est réglable de la vaporisation jusqu'au jet puissant.  
EN Spray adusts from mist to powerful jet.  
IT Cappuccio regolabile, da getto nebulizzato a getto potente.  
PT O pulverizador ajusta-se desde o modo névoa para o modo jato.

Ref				
9001 4027	1	20	2,38	✓

BOQUILLA REGULABLE CONFORT / OUVERTURE RÉGLABLE CONFORT / TWIST NOZZLE WITH ADAPTOR CONFORT  
LANCIA CON APERTURA REGOLABILE CONFORT / INJETOR REGULÁVEL CONFORT



ES El pulverizador se ajusta desde vaporización hasta chorro. Extremo y empuñadura de goma suave.  
FR L'embout du tuyau d'arrosage est réglable de la vaporisation jusqu'au jet puissant. Extrémité et poignée en caoutchouc lisse.  
EN Spray adjusts from mist to powerful jet. Soft rubber grip and tip.  
IT Cappuccio regolabile, da getto nebulizzato a getto potente. Comoda e morbida impugnatura in gomma.  
PT O pulverizador ajusta-se desde o modo névoa para o modo jato. Extremidade e punho em borracha suave.

Ref				
9001 4028	1	10	3,84	✓



REPARADOR / RÉPARATEUR / HOSE MENDER / MANICOTTO DI RIPARAZIONE / ENGATE PARA MANGUEIRA



Ref					
9001 4022	1/2" & 5/8" (13-15 mm)	1	10	1,23	✓
9001 4023	5/8" & 3/4" (15-19 mm)	1	10	1,47	✓

REPARADOR CONFORT / RÉPARATEUR CONFORT / CONFORT HOSE MENDER  
 MANICOTTO DI RIPARAZIONE CONFORT / ENGATE CONFORT PARA MANGUEIRA



Ref					
9001 4018	1/2" & 5/8" (13-15 mm)	1	12	1,83	✓
9001 4019	5/8" & 3/4" (15-19 mm)	1	12	2,15	✓

CONECTOR / CONNECTEUR / QUICK CONNECTOR / CONNETTORE / CONECTOR



Ref					
9001 4024	1/2" & 5/8" (13-15 mm)	1	10	1,83	✓
9001 4025	5/8" & 3/4" (15-19 mm)	1	36	2,15	✓

CONECTOR Y AQUASTOP CONFORT / CONNECTEUR ET AQUASTOP CONFORT / CONFORT QUICK STOP CONNECTOR  
 RACCORDO RAPIDO ACQUA-STOP COMFORT / CONECTOR E AGUA-STOP CONFORT



Ref					
9001 4020	5/8" & 3/4" (15-19 mm)	1	12	2,96	✓
9001 4021	1/2" & 5/8" (13-15 mm)	1	12	2,88	✓

REGULADOR PRESIÓN CONFORT / REGULTEUR / REGULATOR / REGOLATORE DI PRESSIONE COMFORT / REGULADOR CONFORT



Ref				
9001 4034	1	10	4,13	✓



REDUCTOR DE PRESIÓN / RÉDUCTEUR DE PRESSION / PRESSURE REGULATOR / REGOLATORE DI PRESSIONE / REGULADOR DE PRESSÃO



Ref				
9001 4033	1	10	3,86	✓

CONECTOR "Y" / CONNECTEUR "Y" / "Y" SNAP-IN COUPLING / CONNETTORE AD "Y" / CONECTOR "Y"



Ref				
9001 4012	1	10	1,47	✓

CONECTOR / CONNECTEUR / TOOL ADAPTOR / CONNETTORE / CONECTOR



Ref				
9001 4011	1	10	1,05	✓

ADAPTADOR ROSCA MACHO 3/4" / ADAPTATEUR 3/4" / TOOL ADAPTOR 3/4" / ADATTATORE 3/4" / ADAPTADOR 3/4"



Ref					
9001 4010	3/4"	1	10	0,92	✓

ADAPTADOR HEMBRA / ADAPTATEUR FEMELLE / TAP ADAPTOR / ADATTATORE FEMMINA / ADAPTADOR FÊMEA



Ref					
9001 4015	1/2"	1	10	1,03	✓
9001 4016	3/4"	1	10	1,12	✓
9001 4017	1"	1	10	1,20	✓



ADAPTADOR / ADAPTATEUR / INSERT ADAPTOR / ADATTATORE / ADAPTADOR



Ref	H	M				
9001 4013	1/2"	3/4"	1	36	0,99	✓
9001 4014	3/4"	1"	1	12	1,12	✓

COLECTOR DE RIEGO 4 SALIDAS AJUSTABLES / COLLECTEUR D'ARROSAGE 4 SORTIES RÉGLABLES / AJUSTABLE 4 WAYS WATER TRAP  
 CONNETTORE PER IRRIGAZIONE A 4 REGOLABILI / COLETOR DE IRRIGADA 4 SAÍDAS AJUSTÁVEIS

3/4" - 1"

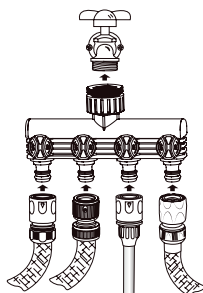

ES Cuatro salidas totalmente ajustables.  
 FR Quatre sorties totalement réglables.  
 EN Four fully adjustable outputs.  
 IT Quattro uscite totalmente regolabili.  
 PT Quatro saídas totalmente ajustáveis.

Ref				
9001 4040	1	32	13,18	✓

COLECTOR DE RIEGO 2 SALIDAS / COLLECTEUR D'IRRIGATION 2 SORTIES / AJUSTABLE 2 WAYS WATER TRAP  
 CONNETTORE PER IRRIGAZIONE A 2 USCITE / COLETOR DE IRRIGADA 2 SAÍDAS

3/4" - 1"

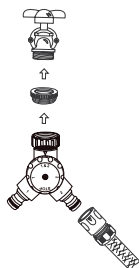

ES Cabeza de 3/4" - 1" / Adaptador de 3/4".  
 FR Tête de de 3/4" - 1"/Adaptateur de 3/4".  
 EN 3/4" - 1" head / 3/4" adaptor.  
 IT Testa da 3/4" - 1" / Adattatore da 3/4".  
 PT Cabeça de 3/4" - 1" / Adaptador de 3/4".

Ref				
9001 4036	1	10	7,13	✓

ADAPTADOR GRIFO 3 FUNCIONES / ADAPTATEUR ROBINET 3 FONCTIONS / TAP ADAPTOR, 3 FUNCTIONS  
 ADATTATORE MULTIFUNZIONE / ADAPTADOR P/TORNEIRA 3 FUNÇÕES

3/4" - 1"

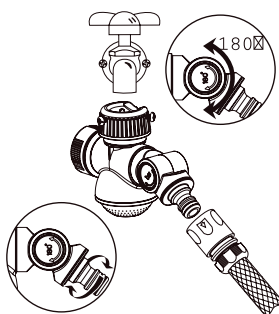

ES Funciones: centro, ducha y conexión a la manguera.  
 FR Fonctions : centre, douche et connexion au tuyau.  
 EN Functions: center, shower and hose connection.  
 IT 3 funzioni: centrale, doccia e connessione del tubo.  
 PT Funções: Centro, chuveiro e conexão da mangueira.

Ref				
9001 4046	1	12	12,92	✓





ADAPTADORES LATÓN MACHO / RACCORD LAITON MALE / BRASS MALE TAP ADAPTOR  
ADATTATORE MASCHIO IN OTTONE / ADAPTADORES EM LATÃO, MACHO



Ref			
9001 4010L	Rosca macho 3/4"	1	2,64

ADAPTADORES LATÓN HEMBRA / RACCORD LAITON FEMELLE / BRASS FEMAL TAP ADAPTOR  
ADATTATORE FEMMINA IN OTTONE / ADAPTADORES EM LATÃO, FÊMEA



Ref			
9001 4015L	HEMBRA 1/2"	1	2,72
9001 4016L	HEMBRA 3/4"	1	2,96
9001 4017L	HEMBRA 1"	1	3,10

CONECTOR LATÓN / CONNECTEUR LAITON / BRASS CONNECTOR / CONNETTORE IN OTTONE / CONECTOR EM LATÃO



Ref			
9001 4020L	1/2" - 5/8" (13-15 mm)	1	6,99
9001 4021L	3/4" (19 mm)	1	8,98

REPARADOR MANGUERA LATÓN / UNION LAITON POUR TUYAU / BRASS HOSE MENDER  
MANICOTTO DI RIPARAZIONE IN OTTONE / ENGATE EM LATÃO PARA MANGUEIRA



Ref			
9001 4018L	1/2" - 5/8" (13-15 mm)	1	6,22
9001 4019L	3/4" (19 mm)	1	11,26

BOQUILLA REGULABRE DE LATÓN / BUSE REGLABLE EN LAITON / BRASS TWIST NOZZLE  
UGELLO IN OTTONE REGOLABILE / BOQUILHA REGULÁVEL DE LATÃO



Ref			
9001 4028L		1	5,62



**RIEGO POR GOTEO / ARROSAGE GOUTTE À GOUTTE / DRIP IRRIGATION  
IRRIGATORE A GOCCIA / IRRIGAÇÃO POR GOTEJAMENTO**



TUBOS DE RIEGO POR GOTEO (SIN GOTERO) / TUYAU D'ARROSAGE (SANS EMBOUT VERSEUR) / IRRIGATION TUBE (WITHOUT DRIPPER)  
TUBO IRRIGAZIONE (SENZA CONTAGOCCE) / TUBOS DE REGA POR GOTEIO (SEN GOTEIRO)



Ref		↔	∅		
9001 6001	■	25 m	16 mm	1	<b>10,40</b>
9001 6006	■	50 m	16 mm	1	<b>19,40</b>
9001 6010	■	100 m	16 mm	1	<b>38,56</b>
				1	
9001 6016	■	25 m	16 mm	1	<b>11,27</b>
9001 6021	■	50 m	16 mm	1	<b>22,53</b>
9001 6026	■	100 m	16 mm	1	<b>45,07</b>

TUBOS DE RIEGO POR GOTEO (CON GOTERO) / TUYAU D'ARROSAGE (AVEC EMBOUT VERSEUR) / IRRIGATION TUBE (WITH DRIPPER)  
TUBO IRRIGAZIONE (CON CONTAGOCCE) / TUBOS DE RIEGO POR GOTEIO (CON GOTEIRO)



Ref		↔		∅		
9001 6002	■	25 m	0,33 m	16 mm	1	<b>11,33</b>
9001 6003	■	25 m	0,50 m	16 mm	1	<b>10,12</b>
9001 6004	■	25 m	0,75 m	16 mm	1	<b>8,68</b>
					1	
9001 6007	■	50 m	0,33 m	16 mm	1	<b>21,53</b>
9001 6008	■	50 m	0,50 m	16 mm	1	<b>19,13</b>
9001 6009	■	50 m	0,75 m	16 mm	1	<b>17,24</b>
					1	
9001 6011	■	100 m	0,33 m	16 mm	1	<b>42,80</b>
9001 6012	■	100 m	0,50 m	16 mm	1	<b>38,01</b>
9001 6013	■	100 m	0,75 m	16 mm	1	<b>34,23</b>
9001 6017	■	25 m	0,33 m	16 mm	1	<b>11,57</b>
9001 6018	■	25 m	0,50 m	16 mm	1	<b>10,45</b>
9001 6019	■	25 m	0,75 m	16 mm	1	<b>9,28</b>
					1	
9001 6022	■	50 m	0,33 m	16 mm	1	<b>23,14</b>
9001 6023	■	50 m	0,50 m	16 mm	1	<b>20,10</b>
9001 6024	■	50 m	0,75 m	16 mm	1	<b>18,56</b>
					1	
9001 6027	■	100 m	0,33 m	16 mm	1	<b>46,28</b>
9001 6028	■	100 m	0,50 m	16 mm	1	<b>40,19</b>
9001 6029	■	100 m	0,75 m	16 mm	1	<b>37,00</b>

GOMAS ESPECIALES PARA EMPALMES RIEGO POR GOTEO / TORIQUES SPÉCIFIQUES AUX RACCORDS D'IRRIGATION PAR GOUTTE  
O-RINGS SPECIAL FOR WATERING BY SPRINKLERS CONNECTORS / GUARNIZIONI TORICHE PER IRRIGATORI  
ANÉIS DE RETENÇÃO ESPECIAIS PARA IRRIGAÇÃO



Ref		↔	∅		
T20X4,5	NBR	1/2"	20	50	<b>0,23</b>
T24X4,5	NBR	3/4"	24	50	<b>0,26</b>
T29,51X5,33	NBR	1"	29,51	50	<b>0,30</b>
T36X6	NBR	1 1/4"	36	50	<b>0,46</b>
T49X7	NBR	1 1/2"	49	50	<b>1,56</b>
T62X8	NBR	2"	62	50	<b>4,11</b>
T69X10	NBR	2 1/2"	69	50	<b>4,11</b>

VÁLVULA DE PASO TUBO / ROBINET POUR TUYAU / VALVE FOR TUBE / VALVOLA DI PASSAGGIO PER TUBO / VALVULA DE PASO TUBO



Ref			
9001 6050	16 mm	100	<b>0,75</b>



CONEXIÓN CTR SIN PASAMUROS / CONNEXION CTR SANS PASAMUROS / CTR CONNECTION NO WALL BUSHING  
CONNETTORE CTR SENZA PRESSACAVO / CONEXION CTR SIN PASAMUROS



Ref			
9001 6051	16 mm	100	0,07

TAPÓN FINAL / BOUCHON / PLUG / TAPPO FINALE / TAPÓN FINAL



Ref			
9001 6052	16 mm	100	0,08

CONEXIÓN EN "T" / RACCORD EN "T" / "T" CONNECTION / CONNESSIONE A "T" / CONEXION EN "T"



Ref			
9001 6053	16 mm	100	0,16

CONEXIÓN CODO 90° / RACCORD COUDE 90° / 90° CONNECTION / CONNESSIONE A GOMITO 90° / CONEXIÓN CODO 90°



Ref			
9001 6054	16 mm	100	0,16

CONEXIÓN CRUZ / RACCORD EN CROIX / CROSS CONNECTION / CONNESSIONE A CROCE / CONEXIÓN CRUZ



Ref			
9001 6055	16 mm	50	0,44

ENLACE RECTO / RACCORD DROIT / STRAIGHT CONNECTION / COLLEGAMENTO DRITTO / ENLACE RECTO



Ref			
9001 6056	16 mm	100	0,07



ENLACE RECTO 1/2" / RACCORD DROIT 1/2" / STRAIGHT CONNECTION 1/2" / COLLEGAMENTO DRITTO 1/2" / ENLACE RECTO 1/2"



Ref				
9001 6057	1/2"	16 mm	100	0,20

ENLACE MIXTO 3/4" / RACCORD MIXTE 3/4" / MIX CONNECTION 3/4" / COLLEGAMENTO MISTO 3/4" / ENLACE MIXTO 3/4"



Ref				
9001 6058	3/4"	16 mm	100	0,25

CONEXIÓN EN "T" R.MACHO 1/2" / RACCORD EN "T" R.MALE 1/2" / "T" CONNECTION MALE THREAD 1/2"  
CONNESSIONE A "T" FILETTO MASCHIO 1/2" / CONEXIÓN EN "T" R.MACHO 1/2"



Ref				
9001 6059	1/2"	16 mm	100	0,47

CONEXIÓN EN "T" R.MACHO 3/4" / RACCORD DANS "T" R.MALE 3/4" / "T" CONNECTION MALE THREAD 3/4"  
CONNESSIONE A "T" FILETTO MASCHIO 3/4" / CONEXIÓN EN "T" R.MACHO 3/4"



Ref				
9001 6060	3/4"	16 mm	100	0,49

CONEXIÓN EN CODO 90° R.MACHO / RACCORD COUDE 90° R.MALE / 90° CONNECTION MALE THREAD  
CONNESSIONE A GOMITO 90° FILETTATO MASCHIO / CONEXIÓN EN CODO 90° R.MACHO



Ref				
9001 6061	1/2"	16 mm	100	0,44
9001 6062	3/4"	16 mm	100	0,45

TAPÓN DOBLE ANILLO PE / BOUCHON DOUBLE ANNEAU PE / DOUBLE RING PLUG PE / DOPPIO ANELLO DI FINE LINEA / TAPÓN DOBLE ANILLO PE



Ref			
9001 6063	16 mm	100	0,07



CONEXIÓN CTR MÁXIMA SEGURIDAD / RACCORD CTR SÉCURITÉ MAXIMUM / CTR HIGH SECURITY CONNECTION  
 CONNESSIONE CRT MASSIMA SICUREZZA CONEXIÓN CTR MÁXIMA SEGURIDAD



Ref			
9001 6071	16 mm	100	0,20

CONEXIÓN EN "T" MÁXIMA SEGURIDAD / RACCORD EN "T" SÉCURITÉ MAXIMUM / HIGH SECURITY "T" CONNECTION  
 CONNESSIONE A "T" MASSIMA SICUREZZA / CONEXIÓN EN "T" MÁXIMA SEGURIDAD



Ref			
9001 6072	16 mm	100	0,31

CONEXIÓN EN CODO MÁXIMA SEGURIDAD / RACCORD COUDE SÉCURITÉ MAXIMUM / HIGH SECURITY 90° CONNECTION  
 CONNESSIONE A GOMITO MASSIMA SICUREZZA / CONEXIÓN EN CODO MÁXIMA SEGURIDAD



Ref			
9001 6073	16 mm	100	0,26

CONEXIÓN EN CRUZ MÁXIMA SEGURIDAD / CONNEXION EN CROIX SÉCURITÉ MAXIMUM / HIGH SECURITY CROSS CONNECTION  
 CONNESSIONE A CROCE MASSIMA SICUREZZA / CONEXIÓN EN CRUZ MÁXIMA SEGURIDAD



Ref			
9001 6074	16 mm	50	0,67

CONEXIÓN EN CODO ROSCA MACHO MÁXIMA SEGURIDAD 1/2" / RACCORD COUDE FILETAGE MALE SÉCURITÉ MAXIMUM 1/2"  
 HIGH SECURITY 90° CONNECTION MALE THREAD 1/2" / CONNESSIONE A GOMITO, FILETTO MASCHIO, MASSIMA SICUREZZA 1/2"  
 CONEXIÓN EN CODO ROSCA MACHO MÁXIMA SEGURIDAD 1/2"



Ref				
9001 6075	1/2"	16 mm	100	0,57





CONEXIÓN EN CODO ROSCA MACHO MÁXIMA SEGURIDAD 3/4" / RACCORD COUDE FILETAGE MALE SÉCURITÉ MAXIMUM 3/4"  
 HIGH SECURITY 90° CONNECTION MALE THREAD 3/4" / CONNESSIONE A GOMITO, FILETTO MASCHIO, MASSIMA SICUREZZA 3/4"  
 CONEXIÓN EN CODO ROSCA MACHO MÁXIMA SEGURIDAD 3/4"



Ref				
<b>9001 6076</b>	3/4"	16 mm	100	<b>0,61</b>

ENLACE MIXTO MACHO MÁXIMA SEGURIDAD 1/2" / RACCORD MIXTE MALE SÉCURITÉ MAXIMUM 1/2" / HIGH SECURITY MIX CONNECTION 1/2"  
 COLLEGAMENTO MISTO MASCHIO, MASSIMA SICUREZZA 1/2" / ENLACE MIXTO MACHO MÁXIMA SEGURIDAD 1/2"



Ref				
<b>9001 6077</b>	1/2"	16 mm	100	<b>0,34</b>

ENLACE MIXTO MACHO MÁXIMA SEGURIDAD 3/4" / RACCORD MIXTE MALE SÉCURITÉ MAXIMUM 3/4" / HIGH SECURITY MIX CONNECTION 3/4"  
 COLLEGAMENTO MISTO MASCHIO, MASSIMA SICUREZZA 3/4" / ENLACE MIXTO MACHO MÁXIMA SEGURIDAD 3/4"



Ref				
<b>9001 6078</b>	3/4"	16 mm	100	<b>0,34</b>

ENLACE RECTO MÁXIMA SEGURIDAD / RACCORD DROIT SÉCURITÉ MAXIMUM / HIGH SECURITY STRAIGHT CONNECTION  
 COLLEGAMENTO DRITTO, MASSIMA SICUREZZA / ENLACE RECTO MÁXIMA SEGURIDAD



Ref			
<b>9001 6070</b>	16 mm	100	<b>0,11</b>



GOTERO PINCHADO C/TORNILLO 5-7 LITROS HORA / EMBOUT GOUTTE A GOUTTE PERFORÉ AVEC VIS 5-7 LITRES A L'HEURE  
 ADJUSTABLE DROPPER C/SCREW 5-7 LITRES HOUR / GOCCIOLATORE CON VITE 5-7 L/H / GOTEJADOR PERFORADOR C/ PARAFUSOS 5-7 LITROS-HORA



Ref		
9001 6081	100	0,07

GOTERO AUTOCOMPENSANTE 2,1 LITROS HORA / EMBOUT GOUTTE A GOUTTE AUTO-COMPENSATION 2.1 LITRES A L'HEURE  
 PRESSURE-COMPENSATING DROPPER 2,1 LITRES HOUR / GOCCIOLATORE AUTOCOMPENSANTE 2,1 L/H / GOTEJADOR AUTOCOMPENSANTE 2,1 LITROS HORA



Ref		
9001 6082	100	0,23

GOTERO AUTOCOMPENSANTE 4,1 LITROS HORA / EMBOUT GOUTTE A GOUTTE AUTO-COMPENSATION 4.1 LITRES A L'HEURE  
 PRESSURE-COMPENSATING DROPPER 4,1 LITRES HOUR / GOCCIOLATORE AUTOCOMPENSANTE 4,1 L/H / GOTEJADOR AUTOCOMPENSANTE 4,1 LITROS HORA



Ref		
9001 6083	100	0,23

GOTERO PINCHADO REGULABLE 0-70 LITROS HORA / EMBOUT GOUTTE A GOUTTE PERFORÉ RÉGLABLE 0-70 LITRES A L'HEURE  
 ADJUSTABLE DROPPER 0-70 LITRES HOUR / GOCCIOLATORE REGOLABILE 0-70 L/H / GOTEJADOR PERFORADOR REGULÁVEL 0-70 LITROS-HORA



Ref		
9001 6080	100	0,10

SACABOCADOS SIMPLE 3 mm / EMPORTE PIECES SIMPLE EMBOUTS 3 mm / SIMPLE PUNCH 3 mm DROPPERS  
 FORATORE SEMPLICE 3 mm GOCCIOLATORE / PERFURADORES SIMPLE 3 mm GOTEJADORES



Ref		
9001 6085	5	6,20



	ES	FR	EN	IT	PT
<b>Ref</b>	Referencia	Référence	Reference	Riferimento	Referência
	Capacidad depósito	Capacité	Capacity	Capacità	Depósito
	Packing	Conditionnement	Packing	Imballo	Embalagem
	Precio	Prix	Price	Prezzo	Preço
	Descripción	Description	Description	Descrizione	Descrição
	Colores	Couleur	Color	Colore	Cores
	Altura	Altura	Height	Altura	Altezza
	Diámetro	Diamètre	Diameter	Diametro	Diâmetro
	Medidas	Mesures	Measurements	Misure	Medidas
	Unidad mínima de venta	Nombre d'unités minimum de vente	Minimum sale unit	Quantitativo minimo di vendita	Unidade mínima de venda
	Peso	Poids	Weight	Peso	Peso
	Espesor	Épaisseur	Thickness	Spessore	Espessura
	Ojo	Yeux	Eye	Occhi	Olho
<b>MODEL</b>	Modelo	Modèle	Model	Modello	Modelo
	Longitud	Longueur	Length	Lunghezza	Comprimento
	Blíster	Blister	Blister	Blister	Blister
	Número de filas, cepillo	Nombre de files, rabot	Number of lines, Brush	N° file spazzole	Número de filas, escovas
	Presión	Pression	Pressure	Pressione	Pressão
	Rosca	Filetage	Thread	Rivettatura	Rosca
	Distancia entre goteros	Distance gouttes	Dropper distance	Distanza gocciolatore	Distância do gotejar
	Material	Matériel	Material	Materiale	Material
	Tubo	Tube	Tube	Tubo	Tubo





 cofan





[www.cofan.es](http://www.cofan.es)



# ÍNDICE / INDEX / CONTENTS

## INDICE / ÍNDICE



### 846

PEQUEÑO MATERIAL / PETIT MATÉRIEL  
SMALL ITEMS / MATERIALE PICCOLO  
PEQUENO MATERIAL



### 891

EQUIPAMIENTO / EQUIPMENT  
FURNITURE AND FITTINGS / ATTREZZATURA  
EQUIPAMENTO



### 860

TORNILLERÍA / VISSERIE / FASTENERS  
VITERIA / FIXADORES



### 894

GLOSARIO / GLASSAIRE / GLOSSARY  
GLOSSARIO / GLOSSÁRIO



### 868

FIJACIÓN / FIXATIONS / FIXING  
COLLANTI / FIXAÇÃO



### 874

EXPOSITORES / PRÉSENTOIRS / DISPLAY STANDS  
ESPOSITORI / EXPOSITORES

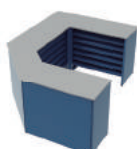

### 889

MOSTRADOR MODULAR / PRESENTOIR MODULAIRE  
MODULAR COUNTER / ESPOSITORE MODULARE  
MOSTRADOR MODULAR





BLÍSTER



ES Modelo del blíster de los productos.

FR Modèle du blister des produits.

EN Products blister model.

IT Modello del blister dei prodotti.

PT Modelo do blister dos produtos.

PASADOR CERROJO NIQUELADO / SERRURE NICKEL / NICKEL PLATED DOOR BOLT  
PERNO SERRAGGIO NICHELATO / FECHO CULATRA NIQUELADO

Bricofan

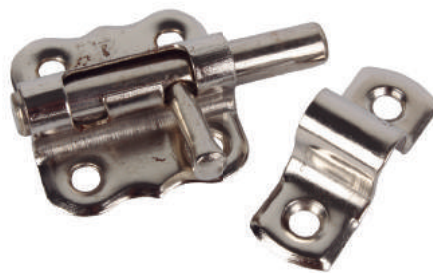

Ref	M			
6100 1101A	30 mm	12	2,95	✓
6100 1102A	40 mm	12	3,34	✓
6100 1103A	50 mm	12	4,36	✓
6100 1104A	60 mm	12	4,50	✓

PASADOR CERROJO LATONADO / SERRURE LAITON / BRASS PLATED DOOR BOLT  
PERNO SERRAGGIO OTTONE / FECHO CULATRA LATONADO

Bricofan



Ref	M			
6100 1111A	30 mm	12	2,85	✓
6100 1112A	35 mm	12	3,08	✓
6100 1113A	40 mm	12	3,33	✓
6100 1114A	50 mm	12	4,50	✓

PASADOR BASE PLÁSTICO / SERRURE BASE PLASTIQUE / PLASTIC DOOR BOLT  
PERNO BASE IN PLASTICA / FECHO CULATRA BASE PLÁSTICO

Bricofan



Ref		M			
6100 1121A		35 mm	12	5,57	✓
6100 1122A		35 mm	12	5,57	✓
6100 1123A		50 mm	12	6,35	✓
6100 1124A		50 mm	12	6,39	✓

MIRILLA DE LATÓN / JUDAS EN LAITON / BRASS SPYHOLE  
SPIONCINO IN OTTONE / VISOR LATONADO

Bricofan



Ref				
6100 1141A	12 x 35 mm	12	3,76	✓
6100 1142A	14 x 35 mm	12	5,66	✓



BLÍSTER



ES Modelo del blíster de los productos.  
 FR Modèle du blister des produits.  
 EN Products blister model.  
 IT Modello del blister dei prodotti.  
 PT Modelo do blister dos produtos.

CIERRES / FERMETURES / LOCKS / CERNIERE / FECHOS ROLETE



Grillete lira zincados / Lire zinguee / Linc lira shackle  
 Grilli a cetra, zincati / Manilha lira zincados

Ref	↓	📦	📊	🛒
6100 1152A	2	12	3,38	✓

CIERRES / FERMETURES / LOCKS / CERNIERE / FECHOS ROLETE



Magnético / Magnetique / Magnetic tip  
 Magnético / Magnético

Ref	🔍	↓	📦	📊	🛒
6100 1155A	■	2	12	3,98	✓

COLGADOR DE ARMARIO ZINCADO / CROCHETS D'ARMOIRE ZINGUEES / ZINC PLATED WARDROBE HOOK  
 CERNIERE PER ARMADIO, ZINCATE / GANCHO DE ZINCO PARA ARMÁRIO



Ref	↔	↓	📦	📊	🛒
6100 1161A	53 mm	2	12	3,47	✓

PERNIO REDONDO / PENTURES RONDRES / ROUND CLAMP  
 CERNIERE ROTONDE / DOBRADIÇA REDONDA

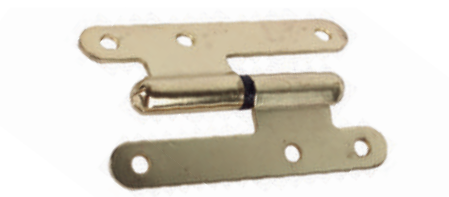

Ref	🔍	↔	↓	📦	📊	🛒
6100 1171A	Derecha Right	9,5 mm	3	12	7,53	✓
6100 1172A	Izquierda Left	9,5 mm	3	12	7,53	✓

BISAGRA DE CAZOLETA / CHARNIERES COUDEE / CUP HINGES / CERNIERE / DOBRADIÇA CANECO



Ref	∅	↓	📦	📊	🛒
6100 1181A	26 mm	2	12	6,72	✓
6100 1182A	35 mm	2	6	8,25	✓





BLÍSTER



ES Modelo del blíster de los productos.

FR Modèle du blister des produits.

EN Products blister model.

IT Modello del blister dei prodotti.

PT Modelo do blister dos produtos.

BISAGRA HIERRO LATÓN FIN ALTO / CHARNIÈRE FER LAITON FIN GRANDES  
BRASS STEEL HINGES WITH TIPS / CERNIERE FERRO OTTONE, PERNO SUPERIORE  
DOBRADIÇA EM FERRO BRONZE PONTA ALTA

Bricofan



Ref					
6100 1191A	25 x 25 mm	2	12	5,60	✓
6100 1192A	35 x 30 mm	2	12	5,81	✓
6100 1193A	40 x 35 mm	2	12	5,97	✓
6100 1194A	50 x 40 mm	2	12	6,17	✓
6100 1195A	60 x 40 mm	2	12	6,60	✓
6100 1196A	70 x 50 mm	2	12	7,61	✓

BISAGRA HIERRO LATÓN / CHARNIÈRE FER LAITON / BRASS STEEL HINGES  
CERNIERE FERRO OTTONE / DOBRADIÇA EM FERRO BRONZE

Bricofan

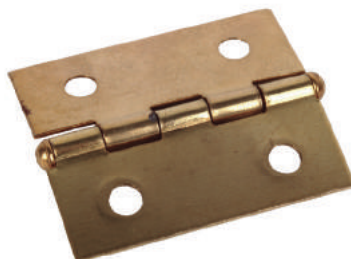

Ref					
6100 1201A	35 x 30 mm	2	12	5,74	✓
6100 1202A	40 x 35 mm	2	12	5,89	✓
6100 1203A	50 x 40 mm	2	12	6,12	✓
6100 1204A	60 x 40 mm	2	12	6,54	✓
6100 1205A	70 x 50 mm	2	12	7,55	✓

CERRADURA BUZÓN RECTA (2 LLAVES) / SERRURE BOÎTE AUX LETTRES DROITE (2 CLÉS) /  
STRAIGHT POSTBOX LOCK (2 KEYS) / SERRATURA DI BLOCCAGGIO DRITTO (2 CHIAVI)  
FECHADURA RETA PARA CAIXA (2 CHAVES)

Bricofan



Ref			
6100 1211A	12	15,27	✓

CERRADURA BUZÓN CURVA (2 LLAVES) / SERRURE BOÎTE AUX LETTRES COURBEE (2 CLÉS)  
CURVE POSTBOX LOCK (2 KEYS) / SERRATURA DI BLOCCAGGIO CURVA (2 CHIAVI)  
FECHADURA CURVA PARA CAIXA (2 CHAVES)

Bricofan



Ref			
6100 1212A	12	15,27	✓

POLEA CON TIRAFONDO / POULIE AVEC TIRE-FOND / PULLEYS WITH WOOD SCREW  
PULEGGE CON TIRAFONDO / ROLDANA COM PARAFUSO

Bricofan



Ref					
6100 1221A	40 mm	2	12	4,45	✓



BLÍSTER



ES Modelo del blíster de los productos.  
FR Modèle du blister des produits.  
EN Products blister model.  
IT Modello del blister dei prodotti.  
PT Modelo do blister dos produtos.

POLEA CON TORNILLO / POULIE AVEC VIS / PULLEYS WITH SCREW  
PULEGGE CON VITE / ROLDANA COM PARAFUSO COM PORCA



Bricofan

Ref	Ø	↓	⊞	⊞	⊞	⊞
6100 1222A	40 mm	2	12	4,45	✓	

PLACA DE UNIÓN / PLAQUES UNION / CONNECTION PLATES  
PLACCHE DI UNIONE / PLACA DE UNIÃO



Bricofan

Ref	⊞	↓	⊞	⊞	⊞	⊞
6100 1231A	35 x 15 mm	4	12	2,48	✓	
6100 1232A	55 x 17 mm	4	12	2,64	✓	
6100 1233A	75 x 20 mm	4	12	2,80	✓	
6100 1234A	95 x 20 mm	4	12	3,12	✓	

ESCUADRA PLANA / CARRÉ PLAT / FLAT SQUARE PLATES  
PLACCHE A SQUADRA PIANA / ESQUADRO PLANO



Bricofan

Ref	↔	↓	⊞	⊞	⊞	⊞
6100 1241A	40 mm	4	12	2,14	✓	
6100 1242A	50 mm	4	12	2,26	✓	
6100 1243A	60 mm	4	12	2,38	✓	
6100 1244A	80 mm	4	12	3,16	✓	

ESCUADRA DE ÁNGULO / CARRE D'ANGLE / FLAT ANGLE PLATES  
PLACCHE A SQUADRA AD ANGOLO / ESQUADRO ANGULAR



Bricofan

Ref	↔	↓	⊞	⊞	⊞	⊞
6100 1251A	20 mm	4	12	2,09	✓	
6100 1252A	30 mm	4	12	2,34	✓	
6100 1253A	40 mm	4	12	2,86	✓	
6100 1254A	50 mm	4	12	3,06	✓	
6100 1255A	60 mm	4	12	3,27	✓	
6100 1256A	70 mm	4	12	3,93	✓	
6100 1257A	80 mm	4	12	4,19	✓	
6100 1258A	100 mm	4	12	4,58	✓	

POMOS / POIGNEE / DRAWER KNOBS / POMELLI / PUXADOR

Bricofan



Ref	⊞	✏	Ø	↓	⊞	⊞	⊞
6100 1261A	ROBLE	30 mm	2	12	8,95	✓	
6100 1262A	ROBLE	40 mm	2	12	10,50	✓	
6100 1263A	PINO	25 mm	2	12	8,54	✓	



## BLÍSTER



ES Modelo del blíster de los productos.

FR Modèle du blister des produits.

EN Products blister model.

IT Modello del blister dei prodotti.

PT Modelo do blister dos produtos.

TOPE PERSIANA / EMBOUT PERSIENNE / BLIND TIPS  
TAPPI ARRESTO SERRANDE / BATENTE PERSIANA

Ref		Ø				
6100 1271A		40 mm	2	12	2,27	✓
6100 1272A		40 mm	2	12	2,27	✓
6100 1273A		40 mm	2	12	2,27	✓
6100 1276A		60 mm	2	12	3,41	✓
6100 1277A		60 mm	2	12	3,41	✓
6100 1278A		60 mm	2	12	3,41	✓

RECOGEDOR ABATIBLE CON CINTA / ENROULEUR RABATTABLE AVEC RUBAN / SIDEWINDER WITH TAPE  
AVVOLGITORE PIEGHEVOLE CON NASTRO / RECOLHEDOR DOBRÁVEL COM FITA

Ref					
6100 1281A		6 m x13 mm	1	16,86	✓
6100 1282A		6 m x14 mm	1	17,39	✓
6100 1283A		6 m x14 mm	1	17,39	✓

RECOGEDOR CINTA COMPACTO PLÁSTICO / ENROULEUR AVEC RUBAN COMPACT PLASTIQUE  
PLASTIC SIDEWINDER WITH TAPE / AVVOLGITORE NASTRO, IN PLASTICA, COMPATTO  
RECOLHEDOR FITA COMPACTO PLÁSTICO

Ref				
6100 1284A	14 mm	1	16,34	✓
6100 1285A	18 mm	1	16,24	✓

TOPE ADHESIVO TORNEADO / EMBOUT ADHÉSIF ROND / ADHESIVE ROUND BLOCK  
FERMAPORTA ADESIVO / BATENTE TORNEADO ADESIVO

Ref					
6100 1311A		Haya	12	4,66	✓
6100 1312A		Nogal	12	4,66	✓

TOPE ADHESIVO OVALADO / EMBOUT ADHÉSIF OVALE / ADHESIVE OVAL BLOCK  
FERMAPORTA ADESIVO OVALE / BATENTE OVALADO ADESIVO

Ref					
6100 1321A		Haya	12	4,62	✓
6100 1322A		Nogal	12	4,62	✓



BLÍSTER



ES Modelo del blíster de los productos.

FR Modèle du blister des produits.

EN Products blister model.

IT Modello del blister dei prodotti.

PT Modelo do blister dos produtos.

TOPE ADHESIVO PLANO / EMBOUT ADHÉSIF PLAT / ADHESIVE FLAT BLOCK  
FERMAPORTA ADESIVO PIANO / BATENTE PLANO ADESIVO

**Bricofan**



Ref					
6100 1331A		Haya	12	4,48	✓
6100 1332A		Nogal	12	4,48	✓

TOPE PUERTA MADERA / STOP PORTE BOIS / WOOD DOOR BLOCK / FERMAPORTA IN LEGNO /  
BATENTE DE PORTA EM MADEIRA

**Bricofan**



Ref				
6100 1341A	40 mm	12	5,56	✓
6100 1342A	60 mm	12	5,47	✓

TOPE ADHESIVO REDONDO METACRILATO / EMBOUT ADHÉSIF ROND METHACRYLATE  
METHACRYLATE ADHESIVE ROUND BLOCK / FERMAPORTA ADESIVO ROTONDO IN METACRILATO  
BATENTE ADESIVO REDONDO ACRÍLICO

**Bricofan**



Ref			
6100 1351A	12	10,77	✓

TOPE ADHESIVO OVALADO METACRILATO / EMBOUT ADHÉSIF OVALE METHACRYLATE  
METHACRYLATE ADHESIVE OVAL BLOCK / FERMAPORTA ADESIVO OVALE IN METACRILATO  
BATENTE ADESIVO OVALADO ACRÍLICO

**Bricofan**



Ref			
6100 1352A	12	10,72	✓

TOPE ADHESIVO PLANO METACRILATO / EMBOUT ADHÉSIF METHACRYLATE  
METHACRYLATE ADHESIVE FLAT BLOCK / FERMAPORTA ADESIVO PIANO IN METACRILATO  
BATENTE ADESIVO PLANO ACRÍLICO

**Bricofan**



Ref			
6100 1353A	12	10,60	✓



BLÍSTER



ES Modelo del blíster de los productos.

FR Modèle du blister des produits.

EN Products blister model.

IT Modello del blister dei prodotti.

PT Modelo do blister dos produtos.

TOPE DE PUERTA DE LATÓN CON TACO / STOP PORTE EN LAITON AVEC FIXATION  
BRASS DOOR BLOCK WITH FIXING PLUG / FERMAPORTA DI OTTONE CON TASSELLO  
BATENTE DE PORTA EM BRONZE COM BUCHA

Bricofan



Ref			
6100 1363A	12	7,47	✓

TOPE DE PUERTA EN LATONADO / STOP PORTE EN LAITON / BRASS PLATED DOOR BLOCK  
FERMAPORTA IN OTTONE / BATENTE DE PORTA EM BRONZE

Bricofan



Ref			
6100 1364A	12	5,06	✓

TOPE CON TACO Y TORNILLO MARRÓN / EMBOUTS AVEC RIVET ET VIS MARRON  
BROWN DOOR BLOCKS WITH FITTING PLUG / FERMAPORTA MARRONE CON TASSELLO E VITE  
BATENTE COM BUCHA E PARAFUSO, CASTANHO

Bricofan



Ref				
6100 1371A	2	12	3,80	✓

TOPE ADHESIVO BASE INOX 40X40 / TOPE ADHESIVO BASE INOX  
WHITE ADHESIVE DOOR BLOCKS, ST. STEEL BASE / FERMAPORTA ADESIVI BIANCHI CON BASE INOX  
BATENTE ADESIVO, BASE INOX

Bricofan



Ref					
6100 1381A		2	12	6,06	✓
6100 1382A		2	12	6,06	✓
6100 1383A		2	12	6,06	✓

TOPE RETENEDOR GIRATORIO MARRÓN / EMBOUT DE RETENTION ROTATIF MARRON  
BROWN REVOLVING DOOR BLOCK / FERMAPORTA ROTATORIO MARRONE  
BATENTE DE RETENÇÃO GIRATÓRIO CASTANHO

Bricofan



Ref				
6100 1384A	2	12	5,06	✓





BLÍSTER



ES Modelo del blíster de los productos.

FR Modèle du blister des produits.

EN Products blister model.

IT Modello del blister dei prodotti.

PT Modelo do blister dos produtos.

ROLLO ALAMBRE GALVANIZADO / ROULEAU FIL GALVANISÉ / ROLL OF GALVANIZED WIRE  
 ROTOLO CAVO GALVANIZZATO / ROLO DE ARAME GALVANIZADO

**Bricofan**



Ref	↔	∅	📦	📊	📄
<b>6100 1471A</b>	75 m	0,7 mm	1	<b>5,61</b>	✓
<b>6100 1472A</b>	50 m	0,9 mm	1	<b>5,43</b>	✓
<b>6100 1473A</b>	50 m	1,1 mm	1	<b>6,14</b>	✓
<b>6100 1474A</b>	40 m	1,3 mm	1	<b>6,66</b>	✓

PALOMILLA CON NERVILO BLANCA / EQUERRE AVEC NERVURE BLANCHE / WHITE WALL BRACKET  
 SUPPORTO PARETE BIANCO / SUPORTE BRANCO COM VINCO

**Bricofan**



Ref	📦	📦	📊
<b>6100 1481A</b>	100 x 75 mm	20	<b>0,52</b>
<b>6100 1482A</b>	125 x 100 mm	20	<b>0,70</b>
<b>6100 1483A</b>	150 x 125 mm	20	<b>0,87</b>
<b>6100 1484A</b>	200 x 150 mm	20	<b>1,13</b>
<b>6100 1485A</b>	250 x 200 mm	20	<b>1,39</b>
<b>6100 1486A</b>	300 x 250 mm	20	<b>2,10</b>
<b>6100 1487A</b>	300 x 350 mm	20	<b>4,07</b>

PALOMILLA REFORZADA BLANCA / EQUERRE RENFORCEE BLANCHE  
 WHITE REINFORCED WALL BRACKET / REGGIMENSOLA RINFORZATO BIANCO  
 POLEIA BRANCA COM REFORÇO

**Bricofan**



Ref	📦	📦	📊
<b>6100 1501A</b>	150 x 200 mm	1	<b>4,89</b>
<b>6100 1502A</b>	200 x 250 mm	1	<b>6,20</b>
<b>6100 1503A</b>	300 x 200 mm	1	<b>6,64</b>
<b>6100 1504A</b>	400 x 250 mm	1	<b>8,91</b>
<b>6100 1505A</b>	500 x 330 mm	1	<b>11,22</b>

PALOMILLA PLEGABLE BLANCA / EQUERRE PLIABLE BLANCHE / WHITE FOLDABLE WALL BRACKET  
 REGGIMENSOLA PIEGHEVOLE BIANCO / POLEIA BRANCA DOBRÁVEL

**Bricofan**



Ref	📦	📦	📊
<b>6100 1511A</b>	200 x 200 mm	1	<b>5,38</b>
<b>6100 1512A</b>	300 x 300 mm	1	<b>9,39</b>
<b>6100 1513A</b>	400 x 400 mm	1	<b>13,41</b>



BLÍSTER



ES Modelo del blíster de los productos.

FR Modèle du blister des produits.

EN Products blister model.

IT Modello del blister dei prodotti.

PT Modelo do blister dos produtos.

PUNTA ACERO CÓNICA COBREIZADA / POINTE ACIER CONIQUE CUIVRE  
COPPERPLATED ST.TIP CONIC HEAD / PUNTA CONICA IN ACCIAIO RAMATO  
PONTA AÇO CÔNICA COBREADO

Bricofan



Ref					
0121 1520A	1,5 x 20 mm	100	12	1,30	✓
0121 2025A	2,0 x 25 mm	65	12	1,30	✓
0121 2030A	2,0 x 30 mm	45	12	1,30	✓
0121 2035A	2,0 x 35 mm	45	12	1,30	✓
0121 2040A	2,0 x 40 mm	30	12	1,30	✓
0121 2045A	2,0 x 45 mm	30	12	1,30	✓

PUNTA DE ACERO CABEZA CÓNICA ZINCADA / POINTE ACIER ZINGUÉE TÊTE CONIQUE  
ST.TIP ZINC PLATED CONIC HEAD / PUNTA A TESTA CONICA IN ACCIAIO ZINCATO  
PONTA DE AÇO, GALVANIZADO, CABEÇA CÔNICA

Bricofan



Ref					
0122 1520A	1,5 x 20 mm	110	12	1,30	✓
0122 2025A	2,0 x 25 mm	65	12	1,30	✓
0122 2030A	2,0 x 30 mm	45	12	1,30	✓
0122 2035A	2,0 x 35 mm	45	12	1,30	✓
0122 2040A	2,0 x 40 mm	30	12	1,30	✓
0122 2045A	2,0 x 45 mm	30	12	1,30	✓

PUNTA ACERO CABEZA PLANA ZINCADA / POINTE ACIER TÊTE PLATE ZINGUÉE  
STEEL TIP ZINC PLATED FLAT HEAD / PUNTA IN ACCIAIO A TESTA PIATTA ZINCATA  
PONTA DE AÇO, CABEÇA CHATA, GALVANIZADO.

Bricofan



Ref					
0123 2530A	2,5 x 30 mm	28	12	1,30	✓
0123 2550A	2,5 x 50 mm	15	12	1,30	✓
0123 2960A	2,9 x 60 mm	13	12	1,30	✓
0123 3440A	3,4 x 40 mm	13	12	1,30	✓
0123 3450A	3,4 x 50 mm	12	12	1,30	✓
0123 3460A	3,4 x 60 mm	9	12	1,30	✓
0123 3470A	3,4 x 70 mm	9	12	1,30	✓

GRAPA PLÁSTICO PLANO / AGRAFE PLASTIQUE PLATE / FLAT PLASTIC CABLE CLAMPS  
FISSACAVI PIANI IN PLASTICA / GRAMPO PLÁSTICO PLANO

Bricofan



Ref					
5100 1090A	3,9 x 2,2 mm	10	12	1,30	✓
5100 1091A	5,4 x 3,3 mm	9	12	1,30	✓
5100 1092A	7,3 x 4,1 mm	8	12	1,30	✓
5100 1093A	9,3 x 5,0 mm	7	12	1,30	✓

GRAPA PLÁSTICA REDONDO / AGRAFE PLASTIQUE ROND / ROUND PLASTIC CABLE CLAMPS  
FISSACAVI TONDI IN PLASTICA / GRAMPO PLÁSTICO REDONDO

Bricofan



Ref					
5100 1094A	6 mm	8	12	1,30	✓
5100 1095A	7 mm	8	12	1,30	✓
5100 1096A	8 mm	8	12	1,30	✓
5100 1097A	9 mm	8	12	1,30	✓
5100 1098A	10 mm	6	12	1,30	✓
5100 1099A	12 mm	4	12	1,30	✓



BLÍSTER



ES Modelo del blíster de los productos.  
FR Modèle du blister des produits.  
EN Products blister model.  
IT Modello del blister dei prodotti.  
PT Modelo do blister dos produtos.

GANCHO PEQUEÑO DE CLAVAR / CROCHET PETIT A CLOUER / WALL FRAME HOOKS  
GANCI DI PICCOLE DIMENSIONI PER MURO / GANCHO PEQUENO DE CRAVAR

**Bricofan**



Ref	↔	↓	📦	📊	📦
6100 0396A	12 mm	9	12	3,11	✓

CUELGACUADROS / ACCROCHE CADRE / WALL FRAME HANGERS  
APPENDIQUADRI / SUPORTE PARA QUADRO

**Bricofan**



Ref	↔	↓	📦	📊	📦
6100 0101A	30 mm	2	10	1,30	✓
6100 0102A	40 mm	2	10	1,30	✓

TACHUELA / TACHUELA / TACKS / CHIODINI / TACHA

**Bricofan**



Ref	🌀	✍	∅	↓	📦	📊	📦
6100 0201A	🟫	LATÓN	8 mm	30	12	1,30	✓
6100 0202A	🟩	NÍQUEL	9,5 mm	20	12	1,30	✓
6100 0203A	🟫	LATÓN	9,5 mm	20	12	1,30	✓
6100 0204A	🟫	LATÓN	10 mm	20	12	1,30	✓

CHINCHETAS / PUNAISES / TACKS / PUNTINE / PIONÉS

**Bricofan**



Ref	🌀	✍	∅	↓	📦	📊	📦
6100 0211A	🟩	NÍQUEL	9,5 mm	35	12	1,30	✓
6100 0212A	🟩	VERDE	9,5 mm	35	12	1,30	✓
6100 0213A	🟩	ROJA	9,5 mm	35	12	1,30	✓
6100 0214A	🟩	AMARILLA	9,5 mm	35	12	1,30	✓
6100 0215A	🟩	BLANCA	9,5 mm	35	12	1,30	✓
6100 0216A	🟩	AZUL	9,5 mm	35	12	1,30	✓

GANCHO CUELGACUADROS / CROCHET SUPPORT TABLEAU / WALL FRAME HANGERS  
GANCI APPENDIQUADRI / GANCHO PARA PENDURAR

**Bricofan**



Ref	Nº	↓	📦	📊	📦
6100 0221A	Nº 0	8	12	1,30	✓
6100 0222A	Nº 1	7	12	1,30	✓
6100 0223A	Nº 2	6	12	1,30	✓
6100 0224A	Nº 3	3	10	1,30	✓
6100 0225A	Nº 4	1	10	1,30	✓



BLÍSTER



ES Modelo del blíster de los productos.

FR Modèle du blister des produits.

EN Products blister model.

IT Modello del blister dei prodotti.

PT Modelo do blister dos produtos.

CUELGACUADROS / SUPPORT TABLEAU / WALL FRAME HANGERS  
APPENDIQUADRI / SUPORTE PARA QUADROS

Bricofan

Ref					
6100 0231A	6 x 6 mm	12	12	1,30	✓
6100 0232A	10 x 10 mm	10	12	1,30	✓
6100 0233A	14 x 14 mm	6	12	1,30	✓
6100 0234A	16 x 16 mm	5	12	1,30	✓

CUELGACUADRO CLAVAR LATÓN / SUPPORT TABLEAU A CLOUSER LAITON  
BRASS WALL FRAME HANGERS / GANCI PARETE OTTONE  
SUPORTE QUADROS DE CRAVAR BRONZE

Bricofan



Ref	Nº				
6100 0261A	Nº 1	2	12	1,30	✓
6100 0262A	Nº 2	2	12	1,30	✓
6100 0263A	Nº 3	1	10	1,30	✓

TOPES DOS PUNTAS PEQUEÑO / EMBOUTS DEUX POINTES PETIT / SMALL WHITE DOOR BLOCKS  
FERMAPORTA A DUE PUNTE, PICCOLO / DESLIZADORES DUAS PONTAS PEQUENO

Bricofan

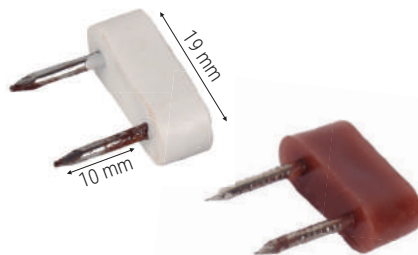

Ref						
6100 0141A	BLANCO	6	12	1,30	✓	
6100 0142A	MARRÓN	6	12	1,30	✓	

TOPES DOS PUNTAS GRANDE / EMBOUTS DEUX POINTES GRANDS / BIG WHITE BLOCKS  
FERMAPORTA A DUE PUNTE, GRANDE / DESLIZADORES DUAS PONTAS GRANDE

Bricofan

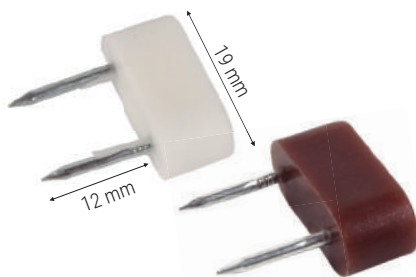

Ref						
6100 0143A	BLANCO	6	12	1,30	✓	
6100 0144A	MARRÓN	6	12	1,30	✓	

TOPE DE SILLA / EMBOUT DE CHAISE / SMALL CHAIR BLOCKS  
GOMMINO PER SEDIA / DESLIZADOR DE CADEIRA

Bricofan

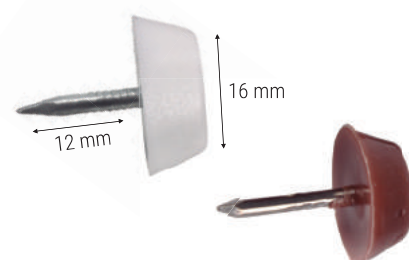

Ref						
6100 0151A	MARRÓN	6	10	1,30	✓	
6100 0152A	BLANCO	6	10	1,30	✓	



BLÍSTER



ES Modelo del blíster de los productos.  
FR Modèle du blister des produits.  
EN Products blister model.  
IT Modello del blister dei prodotti.  
PT Modelo do blíster dos produtos.

TOPE DE SILLA GRANDE / EMBOUT DE CHAISE GRANDS / BIG CHAIR BLOCKS  
GOMMINO GRANDE PER SEDIA / DESLIZADOR GRANDE DE CADEIRA

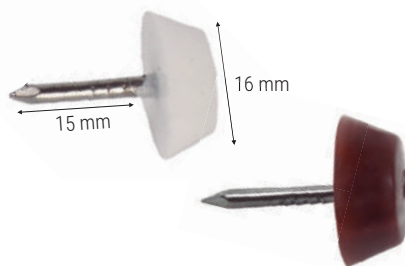

Ref						
6100 0153A	MARRÓN	6	10	1,30	✓	
6100 0154A	BLANCO	6	10	1,30	✓	

TOPE PUERTA COCINA / EMBOUT PORTE CUISINE / KITCHEN DOOR BLOCKS  
GOMMINO PER PORTA CUCINA / DESLIZADOR MÓVEL

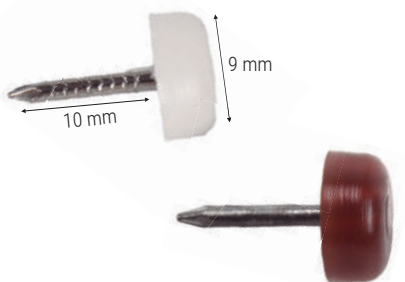

Ref						
6100 0146A	BLANCO	6	12	1,30	✓	
6100 0147A	MARRÓN	6	12	1,30	✓	

SOPORTE DE ESTANTE / SUPPORT D'ÉTAGÈRE / SHELF SUPPORTS  
SUPPORTI PER MENSOLE / SUPORTE DE ESTANTE

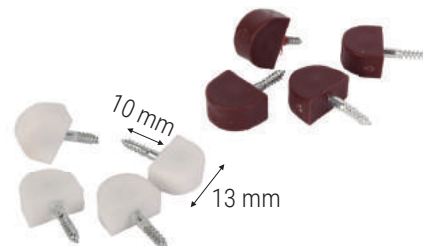

Ref						
6100 0121A	BLANCO	4	12	1,30	✓	
6100 0122A	MARRÓN	4	12	1,30	✓	

SOPORTE DE ESTANTE GRANDE / SUPPORT D'ÉTAGÈRE GRAND / BIG SHELF SUPPORTS  
SUPPORTI PER MENSOLE GRANDI / SUPORTE GRANDE DE ESTANTE

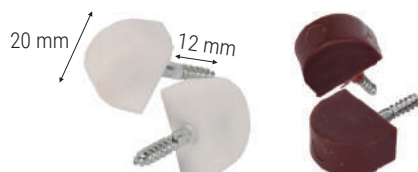

Ref						
6100 0123A	BLANCO	2	12	1,30	✓	
6100 0124A	MARRÓN	2	12	1,30	✓	

SOPORTE VITRINA / SUPPORT VITRINE / GLASS CABINET SUPPORTS  
SUPPORTI MOBILI / SUPORTE PRATELEIRA VIDRO



Ref						
6100 0171A	BLANCO	2	12	1,30	✓	
6100 0172A	MARRÓN	2	12	1,30	✓	





BLÍSTER



ES Modelo del blíster de los productos.

FR Modèle du blister des produits.

EN Products blister model.

IT Modello del blister dei prodotti.

PT Modelo do blister dos produtos.

SOPORTE BARRA ARMARIO / SUPPORT BARRE ARMOIRE / WARDROBE ROD SUPPORTS  
SUPPORTI ASTA ARMADIO / SUPORTE BARRA ARMÁRIO

Bricofan

Ref						
6100 0391A		LATÓN	2	10	3,90	✓
6100 0392A		NÍQUEL	2	10	3,42	✓

SOPORTE DE CORTINAS / SUPPORT DE RIDEAUX / CURTAIN SUPPORTS  
SUPPORTI TENDE / SUPORTE DE CORTINAS

Bricofan

Ref						
6100 0181A		BLANCO	4	12	1,30	✓
6100 0182A		MARRÓN	4	12	1,30	✓

SOPORTE BARRA ARMARIO / SUPPORT BARRE ARMOIRE / WARDROBE ROD SUPPORTS  
SUPPORTO ASTA ARMADIO / SUPORTE BARRA ARMÁRIO

Bricofan

Ref						
6100 0161A		BLANCO	2	10	1,30	✓
6100 0162A		MARRÓN	2	10	1,30	✓

GANCHOS CORTINA ZINCADOS / CROCHETS RIDEAU ZINGUES / ZINC PLATED CURTAIN HOOKS  
GANCI ZINCATI PER TENDE / GANCHOS CORTINAS ZINCADOS

Bricofan

Ref						
6100 0166A		ZINCADO	10	12	1,30	✓

ESPIGA DE MADERA / EMBOUT DE BOIS / WOOD DOWEL PINS  
PERNI LEGNO / CAVILHA DE MADEIRA

Bricofan

Ref						
6100 0116A		6 mm	15	12	1,30	✓
6100 0118A		8 mm	10	10	1,30	✓
6100 0111A		10 mm	7	10	1,30	✓



BLÍSTER



ES Modelo del blíster de los productos.  
FR Modèle du blister des produits.  
EN Products blister model.  
IT Modello del blister dei prodotti.  
PT Modelo do blister dos productos.

CONTERA NEGRA / EMBOUT NOIR / BLACK TIPS / UGELLO NERO / PONTEIRA PRETA



**Bricofan**

Ref	∅	↓	⊞	⊞	⊞
6100 0241A	10 mm	4	10	3,27	
6100 0242A	12 mm	4	10	3,27	
6100 0243A	16 mm	4	10	3,27	
6100 0244A	18 mm	4	10	3,27	
6100 0245A	22 mm	4	10	3,27	

GOTA PROTECTORA ADHESIVA / BULLES DE PROTECTION ADHESIVES / ADHESIVE PROTECTIVE DROPS  
BOLLE ADESIVE DI PROTEZIONE / GOTA DE PROTEÇÃO ADESIVA

**Bricofan**



Ref	⊞	↓	⊞	⊞	⊞
6100 1385A	10 x 3 mm	25	12	2,77	✓
6100 1386A	10 x 1,5 mm	25	12	4,40	✓

FIELTRO REDONDO / FEUTRE ROND / ROUND FELT PADS / FELTRINI ROTONDI / FELTRO REDONDO

**Bricofan**



Ref	⊞	↔	↓	⊞	⊞
6100 0361A	□	17 x 3 mm	2 x 20	10	3,27
6100 0362A	■	17 x 3 mm	2 x 20	10	3,27
6100 0363A	□	22 x 3 mm	2 x 12	10	3,27
6100 0364A	■	22 x 3 mm	2 x 12	10	3,27
6100 0365A	□	27 x 3 mm	2 x 8	10	3,27
6100 0366A	■	27 x 3 mm	2 x 8	10	3,27

FIELTRO CUADRADO / FEUTRE CARRE / SQUARE FELT PADS  
FELTRINI QUADRATI / FELTRO QUADRADO

**Bricofan**



Ref	⊞	↔	↓	⊞	⊞
6100 0371A	□	17x17x3 mm	2 x 20	10	3,27
6100 0372A	■	17x17x3 mm	2 x 16	10	3,27
6100 0373A	□	22x22x3 mm	2 x 12	10	3,27
6100 0374A	■	22x22x3 mm	2 x 12	10	3,27

SEPARADOR DE LLAVES / SÉPARATEUR DE CLÉS / PLASTIC KEY SEPARATORS  
GOMMINI CHIAVI / SEPARADOR DE CHAVES

**Bricofan**



Ref	↓	⊞	⊞	⊞
6100 0251A	5	12	1,30	✓



BLÍSTER



ES Modelo del blíster de los productos.

FR Modèle du blister des produits.

EN Products blister model.

IT Modello del blister dei prodotti.

PT Modelo do blíster dos produtos.

TORNILLOS HEXAGONALES DIN 933  
VIS À MÉTAUX TÊTE HEXAGONALE ENTIÈREMENT FILETÉE ZINGUÉ  
HEXAGON CAP SCREWS FULL THREAD ZINC PLATED  
VITI ACCIAIO TESTA ESAGONALE GAMBO INTERAMENTE FILETTATO ZINCATO  
PARAFUSO HEXAGONAL DIN 933

DIN 933

Bricofan



Ref					
0008 0420A	4,0 x 20 mm	10	12	1,30	✓
0008 0430A	4,0 x 30 mm	8	12	1,30	✓
0008 0520A	5,0 x 20 mm	8	12	1,30	✓
0008 0530A	5,0 x 30 mm	8	12	1,30	✓
0008 0540A	5,0 x 40 mm	6	12	1,30	✓
0008 0620A	6,0 x 20 mm	8	12	1,30	✓
0008 0630A	6,0 x 30 mm	7	12	1,30	✓
0008 0640A	6,0 x 40 mm	6	12	1,30	✓
0008 0650A	6,0 x 50 mm	6	12	1,30	✓
0008 0660A	6,0 x 60 mm	5	10	1,30	✓
0008 0820A	8,0 x 20 mm	3	10	1,30	✓
0008 0830A	8,0 x 30 mm	3	10	1,30	✓
0008 0840A	8,0 x 40 mm	3	10	1,30	✓
0008 0850A	8,0 x 50 mm	3	10	1,30	✓
0008 0860A	8,0 x 60 mm	2	10	1,30	✓

TORNILLOS CABEZA CILÍNDRICA RANURADA / VIS À MÉTAUX TÊTE CYLINDRIQUE FENDUE. ZINGUÉ  
SLOTTED CHEESE HEAD MACHINE SCREWS. ZINC PLATED  
VITI IN FERRO PER METALLO TAGLIO A CACCIAVITE. ZINCATO  
PARAFUSO CABEÇA CILÍNDRICA ZINCADO

DIN 84

Bricofan



Ref					
0060 0310A	3,0 x 10 mm	32	12	1,30	✓
0060 0320A	3,0 x 20 mm	25	12	1,30	✓
0060 0420A	4,0 x 20 mm	14	12	1,30	✓
0060 0430A	4,0 x 30 mm	10	12	1,30	✓
0060 0520A	5,0 x 20 mm	10	12	1,30	✓
0060 0530A	5,0 x 30 mm	6	12	1,30	✓
0060 0540A	5,0 x 40 mm	6	12	1,30	✓
0060 0620A	6,0 x 20 mm	6	12	1,30	✓
0060 0630A	6,0 x 30 mm	6	12	1,30	✓
0060 0640A	6,0 x 40 mm	6	12	1,30	✓
0060 0650A	6,0 x 50 mm	4	12	1,30	✓

TORNILLOS CABEZA AVELLANADA RANURADA / VIS À MÉTAUX TÊTE FRAISÉE FENDUE ZINGUÉ  
SLOTTED COUNTERSUNK HEAD MACHINE SCREWS ZINC PLATED  
VITI IN FERRO PER METALLO TAGLIO A CACCIAVITE ZINCATO  
PARAFUSO CABEÇA ESCAREADA ZINCADO

DIN 963

Bricofan



Ref					
0061 0310A	3,0 x 10 mm	40	12	1,30	✓
0061 0316A	3,0 x 16 mm	35	12	1,30	✓
0061 0420A	4,0 x 20 mm	16	12	1,30	✓
0061 0425A	4,0 x 25 mm	14	12	1,30	✓
0061 0520A	5,0 x 20 mm	15	12	1,30	✓



BLÍSTER



ES Modelo del blíster de los productos.  
FR Modèle du blister des produits.  
EN Products blister model.  
IT Modello del blister dei prodotti.  
PT Modelo do blister dos produtos.

TORNILLO TIRADOR / VIS TIRETTE / EXPAND SCREWS / VITE TIRANTE / PARAFUSO PUXADOR



Ref					
0105 1420A	4 x 20 mm	20	10	2,03	✓
0105 1430A	4 x 30 mm	18	10	2,03	✓
0105 1440A	4 x 40 mm	15	10	2,03	✓
0105 1450A	4 x 50 mm	8	10	2,03	✓

TORNILLO TIRADOR CORTAR / VIS TIRETTE A COUPER / EXPAND SCREWS  
VITE TIRANTE TAGLIO / PARAFUSO PUXADOR CORTAR



Ref					
6100 0331A	4 x 50 mm	4	12	2,66	✓

TORNILLO DE ESTANTERÍA / VIS DE BIBLIOTHÈQUE / BOOKSHELVE SCREWS  
VITI LIBRERIA / PARAFFUSO DE ESTANTE



Ref					
6100 0341A	6 x 15 mm	4	10	2,13	✓

TORNILLO ENSAMBLAR / VIS ASSEMBLAGE / FURNITURE HANDLE SCREWS  
VITE ASSEMBLAGGIO / PARAFUSO MONTAGEM



Ref						
0105 0551A		5 x 50 mm	6	12	1,30	✓
0105 0552A		5 x 50 mm	6	12	1,30	✓
0105 0751A		7 x 50 mm	6	12	1,30	✓
0105 0752A		7 x 50 mm	6	12	1,30	✓

TIRAFONDOS DIN 571 / VIS À BOIS TÊTE HEXAGONALE ZINGUÉ  
HEXAGON HEAD WOOD SCREWS ZINC PLATED  
VITI PER LEGNO IN FERRO TESTA ESAGONALE TIRAFONDI ZINCATO / PARAFUSOS ZINCADOS

DIN 571



Ref					
0126 0640A	6,0 x 40 mm	5	10	1,25	✓
0126 0650A	6,0 x 50 mm	5	10	1,25	✓
0126 0660A	6,0 x 60 mm	5	10	1,25	✓
0126 0850A	8,0 x 50 mm	4	10	1,25	✓
0126 0860A	8,0 x 60 mm	4	10	1,25	✓
0126 0870A	8,0 x 70 mm	2	10	1,25	✓
0126 0880A	8,0 x 80 mm	2	10	1,25	✓
0126 0890A	8,0 x 90 mm	2	10	1,25	✓
0126 08100A	8,0 x 100 mm	2	10	1,53	✓



BLÍSTER



ES Modelo del blíster de los productos.

FR Modèle du blister des produits.

EN Products blister model.

IT Modello del blister dei prodotti.

PT Modelo do blister dos produtos.

TORNILLOS PARA AGLOMERADO DE CABEZA AVELLANADA. POZIDRIVE  
 VIS À BOIS TÊTE FRAISÉE EMPREINTE POZIDRIVE  
 POZIDRIVE CROSS RECESSED COUNTERSUNK HEAD CHIPBOARD SCREWS  
 VITI PER LEGNO IN FERRO POZIDRIVE / PARAFUSO AGLOMERADO CABEÇA ESCAREADA POZIDRIVE

DIN 7505A



Ref					
0250 0316A	3,0 x 16 mm	30	12	1,30	✓
0250 0320A	3,0 x 20 mm	30	12	1,30	✓
0250 0325A	3,0 x 25 mm	30	12	1,30	✓
0250 3516A	3,5 x 16 mm	30	12	1,30	✓
0250 3520A	3,5 x 20 mm	25	12	1,30	✓
0250 3525A	3,5 x 25 mm	17	12	1,30	✓
0250 3530A	3,5 X 30 mm	20	12	1,30	✓
0250 3535A	3,5 x 35 mm	15	12	1,30	✓
0250 3540A	3,5 x 40 mm	15	12	1,30	✓
0250 3545A	3,5 x 45 mm	10	12	1,30	✓
0250 3550A	3,5 x 50 mm	10	12	1,30	✓
0250 0416A	4,0 x 16 mm	22	12	1,30	✓
0250 0420A	4,0 x 20 mm	18	12	1,30	✓
0250 0425A	4,0 x 25 mm	15	12	1,30	✓
0250 0430A	4,0 x 30 mm	12	12	1,30	✓
0250 0435A	4,0 x 35 mm	12	12	1,30	✓
0250 0440A	4,0 x 40 mm	9	12	1,30	✓
0250 0445A	4,0 x 45 mm	8	12	1,30	✓
0250 0450A	4,0 x 50 mm	8	12	1,30	✓
0250 0460A	4,0 x 60 mm	7	12	1,30	✓
0250 4530A	4,5 x 30 mm	15	12	1,30	✓
0250 4540A	4,5 x 40 mm	12	12	1,30	✓
0250 4550A	4,5 x 50 mm	10	12	1,30	✓
0250 0530A	5,0 x 30 mm	10	12	1,30	✓
0250 0535A	5,0 x 35 mm	9	12	1,30	✓
0250 0540A	5,0 x 40 mm	9	12	1,30	✓
0250 0550A	5,0 x 50 mm	7	12	1,30	✓
0250 0560A	5,0 x 60 mm	7	12	1,30	✓
0250 0570A	5,0 x 70 mm	5	10	1,30	✓
0250 0580A	5,0 x 80 mm	4	10	2,92	✓
0250 0650A	6,0 x 50 mm	4	12	2,92	✓
0250 0660A	6,0 x 60 mm	3	12	2,92	✓
0250 0670A	6,0 x 70 mm	3	10	2,92	✓
0250 0680A	6,0 x 80 mm	3	10	2,92	✓
0250 0690A	6,0 x 90 mm	3	10	2,92	✓
0250 06100A	6,0 x 100 mm	3	10	2,92	✓
0250 06120A	6,0 x 120 mm	2	10	2,92	✓

TAPÓN TORNILLO AGLOMERADO / EMBOUT VIS BOIS / SCREW TOPS  
 TAPPI PER VITI LEGNO / TAMPA DE PARAFUSO MADEIRA



Ref					
6100 0176A	BLANCO	18	12	1,30	✓
6100 0177A	MARRÓN	18	12	1,30	✓

TORNILLOS KIT SANITARIO / VIS KIT SANITAIRE / BATHROOM SCREW  
 VITI KIT BAGNO / PARAFUSOS KIT SANITÁRIO

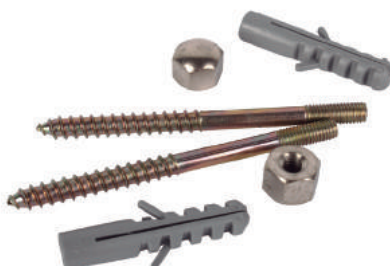

Ref					
6100 0321A	5 x 60 mm	2	12	3,82	✓





BLÍSTER



ES Modelo del blíster de los productos.

FR Modèle du blister des produits.

EN Products blister model.

IT Modello del blister dei prodotti.

PT Modelo do blister dos productos.

TORNILLOS ROSCACHAPA CABEZA CILÍNDRICA ABOMBADA PHILLIPS  
VIS À TÔLE TÊTE CYLINDRIQUE LARGE IMPREINTE PHILLIPS ZINGUÉ  
PHILLIPS CROSS RECESSED PAN HEAD SELF TAPPING SCREWS ZINC PLATED / VITI AUTOFIETTANTI ZINCATO  
PARAFUSO AUTORROSCANTE CABEÇA CILÍNDRICA ABAULADA PHILLIPS ZINCADO

DIN 7981

**Bricofan**



Ref					
0111 3595A	3,5 x 9,5 mm	20	12	1,30	✓
0111 3513A	3,5 x 13 mm	20	12	1,30	✓
0111 3516A	3,5 x 16 mm	20	12	1,30	✓
0111 3519A	3,5 x 19 mm	20	12	1,30	✓
0111 3913A	3,9 x 13 mm	16	12	1,30	✓
0111 3916A	3,9 x 16 mm	15	12	1,30	✓
0111 3919A	3,9 x 19 mm	15	12	1,30	✓
0111 3925A	3,9 x 25 mm	15	12	1,30	✓
0111 4213A	4,2 x 13 mm	20	12	1,30	✓
0111 4216A	4,2 x 16 mm	20	12	1,30	✓
0111 4219A	4,2 x 19 mm	15	12	1,30	✓
0111 4225A	4,2 x 25 mm	12	12	1,30	✓
0111 4232A	4,2 x 32 mm	10	12	1,30	✓
0111 4238A	4,2 x 38 mm	8	12	1,30	✓
0111 4813A	4,8 x 13 mm	20	12	1,30	✓
0111 4816A	4,8 x 16 mm	15	12	1,30	✓
0111 4819A	4,8 x 19 mm	15	12	1,30	✓
0111 4825A	4,8 x 25 mm	9	12	1,30	✓
0111 4832A	4,8 x 32 mm	8	12	1,30	✓
0111 4838A	4,8 x 38 mm	7	12	1,30	✓
0111 4850A	4,8 x 50 mm	5	12	1,30	✓
0111 5525A	5,5 x 25 mm	6	12	1,30	✓
0111 5532A	5,5 x 32 mm	5	12	1,30	✓
0111 5538A	5,5 x 38 mm	5	12	1,30	✓
0111 5550A	5,5 x 50 mm	4	12	1,30	✓

TORNILLO ROSCACHAPA CABEZA AVELLANADA PHILLIPS  
VIS À TÔLE TÊTE FRAISÉE EMPREINTE PHILLIPS ZINGUÉ  
PHILLIPS CROSS RECESSED COUNTERSUNK HEAD SELF TAPPING SCREWS ZINC PLATED  
VITI AUTOFIETTANTI ZINCATO / PARAFUSO AUTORROSCANTE CABEÇA ESCAREADA PHILLIPS

DIN 7982

**Bricofan**



Ref					
0113 4213A	4,2 x 13 mm	30	10	1,25	✓
0113 4216A	4,2 x 16 mm	25	10	1,25	✓
0113 4219A	4,2 x 19 mm	25	10	1,25	✓
0113 4225A	4,2 x 25 mm	20	10	1,25	✓
0113 4232A	4,2 x 32 mm	15	10	1,25	✓
0113 4238A	4,2 x 38 mm	10	10	1,25	✓
0113 4819A	4,8 x 19 mm	20	10	1,25	✓
0113 4825A	4,8 x 25 mm	15	10	1,25	✓

TORNILLOS AUTOTALADRANTES CABEZA AVELLANADA PHILLIPS  
VIS AUTOPERCEUSES TÊTE FRAISÉE EMPREINTE PHILLIPS ZINGUÉ  
SELF-DRILLING SCREWS COUNTERSUNK HEAD PHILLIPS RECESS ZINC PLATED  
VITI AUTOPERFORANTI ZINCATO  
PARAFUSO AUTOPERFORANTE ZINCADO CABEÇA CILÍNDRICA PHILLIPS

DIN 7504P

**Bricofan**



Ref					
0203 3513A	3,5 x 13 mm	15	12	1,30	✓
0203 3516A	3,5 x 16 mm	15	12	1,30	✓
0203 4213A	4,2 x 13 mm	12	12	1,30	✓
0203 4216A	4,2 x 16 mm	10	12	1,30	✓
0203 4219A	4,2 x 19 mm	10	12	1,30	✓
0203 4225A	4,2 x 25 mm	8	12	1,30	✓
0203 4816A	4,8 x 16 mm	9	12	1,30	✓
0203 4819A	4,8 x 19 mm	8	12	1,30	✓
0203 4825A	4,8 x 25 mm	7	12	1,30	✓
0203 4832A	4,8 x 32 mm	6	12	1,30	✓
0203 4838A	4,8 x 38 mm	5	12	1,30	✓



BLÍSTER



ES Modelo del blíster de los productos.

FR Modèle du blister des produits.

EN Products blister model.

IT Modello del blister dei prodotti.

PT Modelo do blister dos produtos.

TORNILLOS AUTOTALADRANTES CABEZA CILÍNDRICA PHILLIPS  
VIS AUTOPERCEUSES TÊTE CYLINDRIQUE EMPREINTE PHILLIPS ZINGUÉ  
SELF-DRILLING SCREWS PAN HEAD PHILLIPS RECESS ZINC PLATED / VITI AUTOPERFORANTI ZINCATO  
PARAFUSO AUTOPERFORANTE ZINCADO CABEÇA CILÍNDRICA PHILLIPS

DIN 7504N

Bricofan



Ref						
0202 3595A	3,5 x 9,5 mm	15	12	1,30	✓	
0202 3513A	3,5 x 13 mm	15	12	1,30	✓	
0202 3516A	3,5 x 16 mm	15	12	1,30	✓	
0202 4213A	4,2 x 13 mm	12	12	1,30	✓	
0202 4216A	4,2 x 16 mm	10	12	1,30	✓	
0202 4219A	4,2 x 19 mm	10	12	1,30	✓	
0202 4225A	4,2 x 25 mm	8	12	1,30	✓	
0202 4816A	4,8 x 16 mm	9	12	1,30	✓	
0202 4819A	4,8 x 19 mm	8	12	1,30	✓	
0202 4825A	4,8 x 25 mm	7	12	1,30	✓	
0202 4832A	4,8 x 32 mm	6	12	1,30	✓	
0202 4838A	4,8 x 38 mm	5	12	1,30	✓	
0202 4845A	4,8 x 45 mm	4	12	1,30	✓	
0202 4850A	4,8 x 50 mm	4	12	1,30	✓	

TORNILLOS AUTOTALADRANTES CABEZA HEXAGONAL CON COLLARÍN  
VIS AUTOPERCEUSES TÊTE HEXAGONALE À EMBASE ZINGUÉ  
SELF-DRILLING SCREWS HEXAGON HEAD WITH FLANGE ZINC PLATED / VITI AUTOPERFORANTI ZINCATO  
PARAFUSO AUTOPERFORANTE ZINCADO CABEÇA HEXAGONAL COM COLARINHO

DIN 7504K

Bricofan



Ref						
0204 3513A	3,5 x 13 mm	12	12	1,30	✓	
0204 3516A	3,5 x 16 mm	10	12	1,30	✓	
0204 4216A	4,2 x 16 mm	8	12	1,30	✓	
0204 4219A	4,2 x 19 mm	8	12	1,30	✓	

TORNILLOS DE CUBIERTA CON ARANDELA ACERO-EPDM  
VIS AUTOPERCEUSES AVEC RONDELLE EPDM-AICER / SELF DRILLING SCREWS WITH NEOPRENE WASHER  
VITI AUTOPERFORANTI CON RANELLE ACCIAIO-EPDM  
PARAFUSO AUTO-PERFORANTE COM ARRUELA EM AÇO EPDM

DIN 7504K

Bricofan



Ref						
0205 4816A	4,8 x 16 mm	8	10	2,37	✓	
0205 4819A	4,8 x 19 mm	8	10	2,37	✓	
0205 5522A	5,5 x 22 mm	6	10	2,37	✓	
0205 6325A	6,3 x 25 mm	5	10	2,37	✓	
0205 6338A	6,3 x 38 mm	4	10	2,37	✓	

ARANDELAS PLANAS / RONDELLES PLATES DÉCOUPÉES ZINGUÉ  
PLAIN STAMPED WASHERS ZINC PLATED / RANELLE ZINCATO / ARRUELAS LISAS

Bricofan



Ref	M				
0052 0003A	M-3	200	12	1,36	✓
0052 0004A	M-4	90	12	1,36	✓
0052 0005A	M-5	70	12	1,36	✓
0052 0006A	M-6	43	12	1,36	✓
0052 0008A	M-8	19	12	1,36	✓
0052 0010A	M-10	12	12	1,36	✓
0052 0012A	M-12	8	12	1,36	✓



BLÍSTER



ES Modelo del blíster de los productos.  
FR Modèle du blister des produits.  
EN Products blister model.  
IT Modello del blister dei prodotti.  
PT Modelo do blister dos produtos.

ARANDELAS PLANAS ALA ANCHA / RONDELLES PLATES / PLAIN WASHERS  
RONDELLE PIANE SERIE LARGA / ARRUELAS LISAS ABA LARGA

DIN 9021

**Bricofan**



Ref	Ø	↓	☒	☒	☒
0053 0412A	4 x 12 mm	30	12	1,30	✓
0053 0515A	5 x 15 mm	20	12	1,30	✓
0053 0618A	6 x 18 mm	15	12	1,30	✓
0053 0824A	8 x 24 mm	10	12	1,30	✓
0053 1030A	10 x 30 mm	6	12	1,30	✓
0053 1236A	12 x 36 mm	3	12	1,30	✓

ARANDELAS GROWER / RONDELLES ÉLASTIQUES "GROWER" ZINGUÉ  
SPRING LOCK WASHERS ZINC PLATED-STEEL  
RANELLE SPACCATE ZINCATO / ARRUELAS GROWER

DIN 127

**Bricofan**



Ref	M	↓	☒	☒	☒
0057 0004A	M-4	60	12	1,30	✓
0057 0005A	M-5	55	12	1,30	✓
0057 0006A	M-6	33	12	1,30	✓
0057 0008A	M-8	12	12	1,30	✓
0057 0010A	M-10	12	12	1,30	✓

ARANDELAS ESTANQUEIDAD EPDM / RONDELLES D'ÉTANCHÉITÉ AVEC JOINT NÉOPRÈNE  
NEOPRENE WASHERS / RANELLE ACCIAIO. EPDM / ARRUELA DE VEDAÇÃO EPDM

**Bricofan**



Ref	Ø	↓	☒	☒	☒
0207 0014A	14 x 4,8 mm	35	10	1,25	✓
0207 0016A	16 x 5,5 mm	30	10	1,25	✓
0207 0018A	18 x 5,5 mm	20	10	1,25	✓
0207 0025A	25 x 6,3 mm	10	10	1,25	✓

ARANDELAS ELÁSTICAS EN ABANICO DENTADO EXTERIOR  
RONDELLES "ÉVENTAIL À DENTURES EXTÉRIEURES" / SERRATED LOCK WASHERS EXTERNAL TEETH  
RANELLE DENTELLATE / ARRUELAS ELÁSTICAS DENTADAS EXTERNAS

DIN 6798A

**Bricofan**



Ref	M	↓	☒	☒	☒
0051 0004A	M-4	60	12	2,03	✓
0051 0005A	M-5	45	12	2,03	✓
0051 0006A	M-6	30	12	2,03	✓
0051 0008A	M-8	20	12	2,03	✓

TUERCAS HEXAGONALES / ECROUS HEXAGONAUX ZINGUÉ / HEXAGON NUTS ZINC PLATED  
DADI ESAGONALI ZINCATO / PORCA HEXAGONAL

DIN 934

**Bricofan**



Ref	M	↓	☒	☒	☒
0032 0003A	M-3	70	12	1,30	✓
0032 0004A	M-4	48	12	1,30	✓
0032 0005A	M-5	30	12	1,30	✓
0032 0006A	M-6	18	12	1,30	✓
0032 0008A	M-8	9	12	1,30	✓
0032 0010A	M-10	7	12	1,30	✓
0032 0012A	M-12	3	12	1,30	✓



BLÍSTER



ES Modelo del blíster de los productos.

FR Modèle du blister des produits.

EN Products blister model.

IT Modello del blister dei prodotti.

PT Modelo do blister dos produtos.

TUERCA HEXAGONAL AUTOBLOCANTE NYLON ZINCADO  
 ECROUS EXAGONAUX INDESSERABLES AVEC BAGUE NYLON ZINGUÉ  
 EXAGON LOCKNUT WITH NYLON INSERT ZINC PLATED  
 DADI ZINCATI ESAGONALI CON INSERTO IN NYLON, AUTOFRENANTI  
 PORCA EXAGONAL AUTO-BLOQUEANTE NYLON ZINCADO

DIN 985



Ref	M	↓	⊞	⊞	⊞	⊞
0037 0004A	M-4	12	12	1,30	✓	
0037 0005A	M-5	10	12	1,30	✓	
0037 0006A	M-6	6	12	1,30	✓	
0037 0008A	M-8	4	12	1,30	✓	
0037 0010A	M-10	2	12	1,30	✓	
0037 0012A	M-12	2	12	1,30	✓	

Bricofan

TUERCAS CIEGAS / ECROUS BORGNES / HEXAGON CAP NUTS  
 DADI ESAGONALI CIECHI CON CALOTTA SFERICA / TUERCA CIEGA

DIN 1587



Ref	M	↓	⊞	⊞	⊞	⊞
0033 0004A	M-4	4	12	1,30	✓	
0033 0005A	M-5	4	12	1,30	✓	
0033 0006A	M-6	4	12	1,30	✓	
0033 0008A	M-8	2	10	1,30	✓	

Bricofan

TUERCAS DE MARIPOSA / ECROUS À OREILLES FORME AMÉRICAINE / WING NUTS AMERICAN TYPE  
 DADI CON ALETTE / PORCA DE BORBOLETA

DIN 315



Ref	M	↓	⊞	⊞	⊞	⊞
0034 0003A	M-3	8	12	2,03	✓	
0034 0004A	M-4	6	12	2,03	✓	
0034 0005A	M-5	6	12	2,03	✓	
0034 0006A	M-6	4	12	2,03	✓	
0034 0008A	M-8	2	10	2,03	✓	

Bricofan

TUERCAS EMPOTRABLES / ECROUS ENCASTRABLES / FITTED NUTS  
 DADI PREASSEMBALTI / PORCAS EMBUTIDAS



Ref	M	↓	⊞	⊞	⊞	⊞
6100 0133A	M-6	2	12	1,30	✓	

Bricofan

MANGUITOS HEXAGONALES. UNIÓN VARILLAS ROSCADAS / ECROUS HEXAGONAUX  
 HEXAGON NUTS / DADI DI CONGIUNZIONE / MANGA HEXAGONAL UNIÃO DE HASTES ROSCADAS

DIN 6334



Ref		⊞	↓	⊞	⊞	⊞
0048 0620A	6 x 20 mm	5	10	1,25	✓	
0048 0630A	6 x 30 mm	4	10	1,25	✓	
0048 0825A	8 x 25 mm	4	10	1,25	✓	
0048 1030A	10 x 30 mm	2	10	1,25	✓	

Bricofan



BLÍSTER



ES Modelo del blister de los productos.

FR Modèle du blister des produits.

EN Products blister model.

IT Modello del blister dei prodotti.

PT Modelo do blister dos produtos.

ALCAYATAS Y HEMBRILLAS ZINCADAS / CROCHET DE FIXATION / FIXATION HOOKS  
GANCIO DI FISSAGGIO / ESCÁPULAS E GANCHOS ZINCADOS



Bricofan

Ref		Ø	↓			
0106 1425A	14 x 25 mm	2,1 mm	25	12	1,30	✓
0106 1630A	16 x 30 mm	2,4 mm	25	12	1,30	✓
0106 1735A	17 x 35 mm	2,7 mm	25	12	1,30	✓
0106 1740A	17 x 40 mm	2,7 mm	20	12	1,30	✓
0106 1840A	18 x 40 mm	3,0 mm	15	12	1,30	✓
0106 1850A	18 x 50 mm	3,0 mm	10	12	1,30	✓
0106 1950A	19 x 50 mm	3,5 mm	10	12	1,30	✓
0106 1960A	19 x 60 mm	3,5 mm	7	12	1,30	✓
0106 2050A	20 x 50 mm	4,0 mm	8	12	1,30	✓
0106 2060A	20 x 60 mm	4,0 mm	6	12	1,30	✓
0106 2070A	20 x 70 mm	4,0 mm	6	12	1,30	✓
0106 2170A	21 x 70 mm	4,5 mm	4	12	1,30	✓



Bricofan

Ref		Ø	↓			
0107 1425A	14 x 25 mm	2,1	25	12	1,30	✓
0107 1630A	16 x 30 mm	2,4	24	12	1,30	✓
0107 1735A	17 x 35 mm	2,7	18	12	1,30	✓
0107 1740A	17 x 40 mm	2,7	18	12	1,30	✓
0107 1850A	18 x 50 mm	3,0	10	12	1,30	✓
0107 1960A	19 x 60 mm	3,5	6	12	1,30	✓
0107 2050A	20 x 50 mm	4,0	10	10	1,25	✓
0107 2070A	20 x 70 mm	4,0	4	12	1,30	✓
0107 2180A	21 x 80 mm	4,5	4	12	1,30	✓



Bricofan

Ref		Ø	↓			
0108 1425A	14 x 25 mm	2,1	25	12	1,30	✓
0108 1630A	16 x 30 mm	2,4	25	12	1,30	✓
0108 1735A	17 x 35 mm	2,7	17	12	1,30	✓
0108 1740A	17 x 40 mm	2,7	15	12	1,30	✓
0108 1850A	18 x 50 mm	3,0	8	12	1,30	✓
0108 1960A	19 x 60 mm	3,5	5	12	1,30	✓
0108 2050A	20 x 50 mm	4,0	10	10	1,25	✓
0108 2070A	20 x 70 mm	4,0	5	12	1,30	✓
0108 2180A	21 x 80 mm	4,5	3	12	1,30	✓





**BLÍSTER**



ES Modelo del blíster de los productos.

FR Modèle du blister des produits.

EN Products blister model.

IT Modello del blister dei prodotti.

PT Modelo do blíster dos produtos.

TACO PLACA YESO / CHEVILLE PLAQUE PLÂTRE / PLASTER CAST PLUGS  
TASSELLO PLACCA IN GESSO / BUCHA PLACA GESSO



Ref					
6100 0302A	10 x 47 mm	4	10	2,66	✓
6100 0303A	10 x 38 mm	8	10	2,66	✓

TACO NYLON CON ALCAYATA / CHEVILLE NYLON AVEC PITON / NYLON PLUGS WITH HOOK  
TASSELLO IN NYLON CON GANCIO / BUCHA NYLON COM PARAFUSO GANCHO



Ref					
6100 0311A	5 x 45 mm	2	10	3,82	✓

TACO NYLON CON GANCHO / CHEVILLE NYLON AVEC CROCHET / NYLON PLUGS WITH HOOK  
TASSELLI IN NYLON CON GANCIO / BUCHA NYLON COM GANCHO



Ref					
6100 0312A	4 x 40 mm	2	10	3,82	✓

TACO NYLON CON ARGOLLA / CHEVILLE NYLON AVEC ANNEAU / NYLON PLUGS WITH HOOK  
TASSELLI IN NYLON CON OCCHIELLO / BUCHA NYLON COM ARGOLA



Ref					
6100 0313A	4 x 40 mm	2	10	3,82	✓

TACO NYLON CON TORNILLO / CHEVILLE NYLON AVEC VIS / NYLON PLUGS WITH SCREW  
TASSELLI IN NYLON CON VITE / BUCHA NYLON COM PARAFUSO



Ref					
6100 0314A	5 x 45 mm	2	10	3,82	✓



BLÍSTER



ES Modelo del blister de los productos.

FR Modèle du blister des produits.

EN Products blister model.

IT Modello del blister dei prodotti.

PT Modelo do blister dos produtos.

TACOS DE FIJACIÓN DE NYLON POR EXPANSIÓN / CHEVILLES DE FIXATION NYLON POUR EXPANSION NYLON FIXING PLUGS / TASSELLO FISSAGGIO AD ESPANSIONE / BUCHAS DE FIXAÇÃO EM NYLON

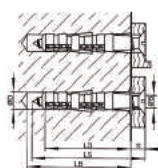

Ref	M	↓	↕	⌵	☑
0760 0004A	M-4	22	12	1,30	✓
0760 0005A	M-5	16	12	1,30	✓
0760 0006A	M-6	12	12	1,30	✓
0760 0008A	M-8	8	12	1,30	✓
0760 0010A	M-10	4	12	1,30	✓
0760 0012A	M-12	3	10	1,30	✓

TACOS ANUDABLES DE GRAN EXPANSIÓN / CHEVILLES DE FIXATION NYLON POUR EXPANSION GREAT EXPANSION PLUGS / TASSELLO IN NYLON / BUCHAS DE GRANDE EXPANSÃO

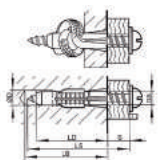

Ref	M	↓	↕	⌵	☑
0761 0005A	M-5	12	12	1,30	✓
0761 0006A	M-6	10	12	1,30	✓
0761 0008A	M-8	5	12	1,30	✓
0761 0010A	M-10	4	10	1,30	✓

TACOS RÁPIDOS GOLPE COLLARÍN AVELLANADO / CHEVILLES RAPIDES NYLON FIXING-PLUGS COUNTERSUNK / TASSELLO RAPIDO CON TESTA SVASATA BUCHA GOLPE RÁPIDO COM BORDA ESCAREADA

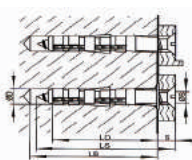

Ref		↔	↓	↕	⌵	☑
0770 0640A	6 x 40 mm	5	10	1,25	✓	
0770 0660A	6 x 60 mm	2	10	1,25	✓	
0770 0860A	8 x 60 mm	2	10	1,25	✓	
0770 0880A	8 x 80 mm	2	10	1,25	✓	

TACO PLÁSTICO BLANCO / CHEVILLE PLASTIQUE BLANCHE / WHITE PLASTIC FIXING PLUGS - CALZE PER TASSELLI BIANCHE / BUCHA PLÁSTICO BRANCO



Ref		↔	↓	↕	⌵	☑
0760 2006A	6 mm	15	10	1,30	✓	
0760 2007A	7 mm	15	10	1,30	✓	
0760 2008A	8 mm	10	10	1,30	✓	
0760 2009A	9 mm	6	10	1,30	✓	
0760 2010A	10 mm	5	10	1,30	✓	

CUELGAFÁCIL CON PROTECTOR / FIXATION FACILE AVEC PROTECTEUR / HOOKS WITH PROTECTOR GANCI PER QUADRI CON CHIODI / PENDURA FÁCIL COM PROTETOR



Ref	↓	↕	⌵	☑
6100 0301A	15	12	2,51	✓



**BLÍSTER**



ES Modelo del blíster de los productos.

FR Modèle du blister des produits.

EN Products blister model.

IT Modello del blister dei prodotti.

PT Modelo do blíster dos produtos.

ANILLOS SEEGER DIN 471 PARA EJES EXTERIORES / ANEAUX SEEGER DIN 471 POUR AXES EXTÉRIEURS  
DIN 471 SEEGER RINGS EXTERIOR SPINDLE / ANELLO SEEGER DIN 471 PER ALBERO  
ANEIS SEEGER DIN 471 PARA EIXOS EXTERIORES

**Bricofan**



Ref						
0471 A006A	A-6 x 0,7 mm	20	10	1,25	✓	
0471 A007A	A-7 x 0,8 mm	20	10	1,25	✓	
0471 A008A	A-8 x 0,8 mm	20	10	1,25	✓	
0471 A010A	A-10 x 1,0 mm	15	10	1,25	✓	
0471 A012A	A-12 x 1,0 mm	15	10	1,25	✓	
0471 A014A	A-14 x 1,0 mm	10	10	1,25	✓	

Ref						
0471 A015A	A-15 x 1,0 mm	10	10	1,25	✓	
0471 A018A	A-18 x 1,2 mm	10	10	1,25	✓	
0471 A019A	A-19 x 1,2 mm	10	10	1,25	✓	
0471 A020A	A-20 x 1,2 mm	5	10	1,25	✓	
0471 A021A	A-21 x 1,2 mm	5	10	1,25	✓	
0471 A022A	A-22 x 1,2 mm	5	10	1,25	✓	
0471 A025A	A-25 x 1,2 mm	5	10	1,25	✓	
0471 A028A	A-28 x 1,2 mm	5	10	1,25	✓	
0471 A030A	A-30 x 1,5 mm	5	10	1,25	✓	
0471 A035A	A-35 x 1,5 mm	2	10	1,25	✓	
0471 A036A	A-36 x 1,75 mm	2	10	1,25	✓	
0471 A040A	A-40 x 1,75 mm	2	10	1,25	✓	

ANILLOS SEEGER DIN 472 PARA AGUJEROS INTERIORES / ANEAUX SEEGER DIN 472 POUR AXES INTÉRIEURS  
DIN 472 SEEGER RINGS INTERIOR SPINDLE / ANELLO SEEGER DIN 472 PER MOZZO  
ANEIS SEEGER DIN-472 PARA FURUS INTERIORES

**Bricofan**



Ref						
0472 J008A	J-8 x 0,8 mm	15	10	1,25	✓	
0472 J010A	J-10 x 1,0 mm	15	10	1,25	✓	
0472 J014A	J-14 x 1,0 mm	10	10	1,25	✓	
0472 J020A	J-20 x 1,0 mm	5	10	1,25	✓	
0472 J022A	J-22 x 1,0 mm	5	10	1,25	✓	
0472 J024A	J-24 x 1,2 mm	5	10	1,25	✓	

Ref						
0472 J028A	J-28 x 1,2 mm	5	10	1,25	✓	
0472 J032A	J-32 x 1,2 mm	4	10	1,25	✓	
0472 J034A	J-34 x 1,5 mm	4	10	1,25	✓	
0472 J036A	J-36 x 1,5 mm	2	10	1,25	✓	
0472 J038A	J-38 x 1,5 mm	2	10	1,25	✓	
0472 J040A	J-40 x 1,75 mm	2	10	1,25	✓	

ANCLAJES METÁLICOS TORNILLO HEXAGONAL 6.8  
CHEVILLES EN ACIER À VIS DE TÊTE HEXAGONALE 6.8  
STEEL BOLTS WITH HEXAGONAL HEAD SCREW 6.8  
TASSELLO METALLICO CON VITE A TESTA ESAGONALE 6.8  
BUCHA METÁLICA COM PARAFUSO HEX 6.8

**Bricofan**

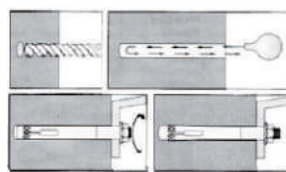

Ref						
0762 0845A	6/8 x 45 mm	2	10	1,25	✓	
0762 0860A	6/8 x 60 mm	2	10	1,25	✓	
0762 1060A	8/10 x 60 mm	2	10	1,25	✓	
0762 1080A	8/10 x 80 mm	1	10	1,25	✓	

ANCLAJES METÁLICOS CON ARGOLLA 6.8 / CHEVILLES EN ACIER À BAGE 6.8  
STEEL BOLTS WITH EYE 6.8 / TASSELLO ACCIAIO 6.8 / BUCHA METÁLICA COM ARGOLA

**Bricofan**

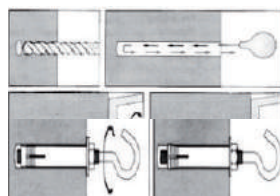

Ref						
0765 0845A	6/8 x 45 mm	2	10	1,25	✓	
0765 1060A	8/10 x 60 mm	1	10	1,85	✓	
0765 1270A	10/12 x 70 mm	1	10	2,15	✓	



BLÍSTER



ES Modelo del blíster de los productos.

FR Modèle du blister des produits.

EN Products blister model.

IT Modello del blister dei prodotti.

PT Modelo do blister dos produtos.

ANCLAJES METÁLICOS CON GANCHO 6.8 / CHEVILLES EN ACIER À CROCHET 6.8  
STEEL BOLTS WITH HOOK 6.8 / TASSELLO ACCIAIO 6.8 / BUCHA METÁLICA COM GANCHO

Bricofan

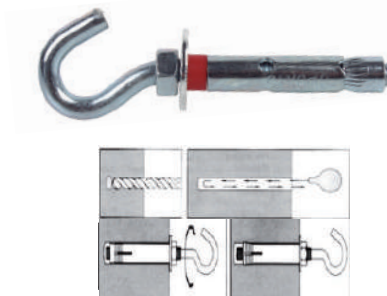

Ref					
0766 0845A	6/8 x 45 mm	1	10	1,85	✓
0766 1060A	8/10 x 60 mm	1	10	1,85	✓
0766 1270A	10/12 x 70 mm	1	10	2,15	✓

REMACHES ESTÁNDAR CABEZA ALOMADA / RIVETS ALUMINIUM STANDARD  
ALUMINIUM STANDARD, DOME HEAD / RIVETTO IN ALLUMINIO STANDARD, TESTA BOMBATA  
REBITES STANDARD CABEÇA ABAULADA

Bricofan

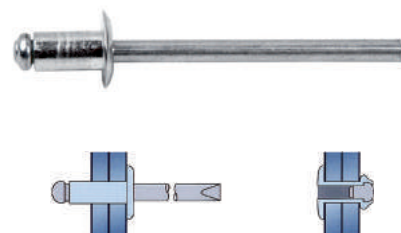

Ref					
0701 4008A	4,0 x 8 mm	20	10	2,12	✓
0701 4010A	4,0 x 10 mm	20	10	2,12	✓
0701 4016A	4,0 x 16 mm	17	10	2,12	✓
0701 4810A	4,8 x 10 mm	15	10	2,12	✓
0701 4812A	4,8 x 12 mm	15	10	2,12	✓
0701 4816A	4,8 x 16 mm	15	10	2,12	✓

REMACHES ALUMINIO ESTÁNDAR CABEZA ANCHA / RIVETS ALU LÈVRE LARGE  
ALUMINIUM STANDARD, LARGE HEAD / RIVETTO IN ALLUMINIO A TESTA LARGA  
REBITES ALUMÍNIO STANDARD CABEÇA GRANDE

Bricofan

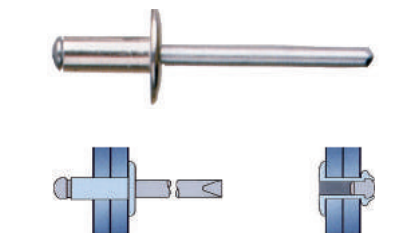

Ref					
0704 4010A	4,0 x 10 mm	15	10	1,25	✓
0704 4016A	4,0 x 16 mm	10	10	1,25	✓
0704 4812A	4,8 x 12 mm	10	10	1,25	✓
0704 4816A	4,8 x 16 mm	10	10	1,25	✓
0704 4821A	4,8 x 21 mm	5	10	1,25	✓

PASADORES Y CLIPS DIN 94 / GOUPILLES ET CLIPS DIN 94 / SPLIT PINS AND CLIPS DIN 94  
SPINE A COPPIGLIA DIN 94 / GOLPILHAS E CLIPS DIN 94

Bricofan



Ref					
0020 1516A	1,5 x 16 mm	25	10	1,25	✓
0020 1525A	1,5 x 25 mm	25	10	1,25	✓
0020 1536A	1,5 x 36 mm	20	10	1,25	✓
0020 2025A	2,0 x 25 mm	20	10	1,25	✓
0020 2032A	2,0 x 32 mm	20	10	1,25	✓
0020 2040A	2,0 x 40 mm	20	10	1,25	✓
0020 2536A	2,5 x 36 mm	20	10	1,25	✓
0020 2540A	2,5 x 40 mm	20	10	1,25	✓
0020 3236A	3,2 x 36 mm	15	10	1,25	✓
0020 3245A	3,2 x 45 mm	15	10	1,25	✓
0020 3550A	3,5 x 50 mm	10	10	1,25	✓
0020 3563A	3,5 x 63 mm	5	10	1,25	✓
0020 4040A	4,0 x 40 mm	10	10	1,25	✓
0020 4050A	4,0 x 50 mm	10	10	1,25	✓
0020 4063A	4,0 x 63 mm	5	10	1,25	✓
0020 5063A	5,0 x 63 mm	5	10	1,25	✓
0020 5070A	5,0 x 70 mm	2	10	1,25	✓
0020 5080A	5,0 x 80 mm	2	10	1,25	✓
0020 6380A	6,3 x 80 mm	1	10	1,25	✓
0020 63100A	6,3 x 100 mm	1	10	1,25	✓



**BLÍSTER**



ES Modelo del blíster de los productos.  
FR Modèle du blister des produits.  
EN Products blister model.  
IT Modello del blister dei prodotti.  
PT Modelo do blíster dos productos.

PASADORES Y CLIPS / GOUPILLES ET CLIPS / SPLIT PINS AND CLIPS  
SPINE A COPPIGLIA / CAVILHA E CLIPS



Ref					
0021 0002A	2 mm	10	10	1,25	✓
0021 0003A	3 mm	5	10	1,25	✓
0021 0004A	4 mm	2	10	1,25	✓
0021 0005A	5 mm	1	10	1,25	✓

PASADORES ELÁSTICOS DIN 1481 / GOUPILLES DIN 1481 / SPLIT PINS DIN 1481  
SPINE ELASTICHE IN ACCIAIO DIN 1481 / CAVILHAS ELÁSTICAS



Ref					
1481 0230A	2 x 30 mm	15	10	1,25	✓
1481 0328A	3 x 28 mm	10	10	1,25	✓
1481 0350A	3 x 50 mm	10	10	1,25	✓
1481 0430A	4 x 30 mm	5	10	1,25	✓
1481 0440A	4 x 40 mm	5	10	1,25	✓
1481 0520A	5 x 20 mm	5	10	1,25	✓
1481 0530A	5 x 30 mm	5	10	1,25	✓
1481 0550A	5 x 50 mm	5	10	1,25	✓
1481 0640A	6 x 40 mm	3	10	1,25	✓
1481 0660A	6 x 60 mm	2	10	1,25	✓

**ENGRASE / CADENAS / PADLOCKS / LUCCHETTI / LUBRIFICAÇÃO**

ENGRASADORES / GRAISSEUR / GREASERS / INGRASSATORE / LUBRIFICADOR

Recto / Droite / Straight / Dritto / Reto



Ref					
3150 0104GA	1/4" GAS	2	10	1,25	✓
3150 0108GA	1/8" GAS	2	10	1,25	✓
3150 6100A	6/100	3	10	1,25	✓
3150 8100A	8/100	2	10	1,25	✓
3150 8125A	8/125	2	10	1,25	✓
3151 0100A	10/100	2	10	1,25	✓
3151 0150A	10/150	2	10	1,25	✓

45° - Semicurvo / Semi curve / Semi curved  
Semicurvo / Semi curvo



Ref					
3160 6100A	6/100	1	10	1,25	✓
3160 8100A	8/100	1	10	1,25	✓
3160 8125A	8/125	1	10	1,25	✓
3161 0100A	10/100	1	10	1,25	✓

90° - Curvo / Courbé / Curved / Curvo / Curvo



Ref					
3170 6100A	6/100	1	10	1,25	✓
3170 8100A	8/100	1	10	1,25	✓
3170 8125A	8/125	1	10	1,25	✓
3171 0100A	10/100	1	10	1,25	✓
3171 0150A	10/150	1	10	1,25	✓





BLÍSTER



ES Modelo del blíster de los productos.  
FR Modèle du blister des produits.  
EN Products blister model.  
IT Modello del blister dei prodotti.  
PT Modelo do blister dos produtos.

COLGADOR AUTOADHESIVO / CROCHET AUTO-ADHÉSIF / AUTO ADHESIVE HANGER  
GANCIO AUTOADESIVO IN / GANCHO AUTOCOLANTE

**Bricofan**



Ref	🔄	↓	📦	📊	📄
6100 1391A	INOX	2	12	2,05	✓

COLGADOR AUTOADHESIVO. OVAL GRANDE / CROCHET AUTO-ADHÉSIF. OVALE GRAND FORMAT  
AUTO ADHESIVE HANGER OVAL BIG / GANCIO GRANDE, OVALE, AUTOADESIVO IN ACCIAIO  
GANCHO AUTOCOLANTE OVAL GRANDE

**Bricofan**



Ref	🔄	↓	📦	📊	📄
6100 1392A	INOX	2	12	2,05	✓

COLGADOR VENTOSA CIERRE SEGURIDAD / CROCHET VENTOUSE FERMETURE DE SÉCURITÉ  
HANGER SUCTION PAD SAFETY LOCK / GANCIO CON VENTOSA E BLOCCO DI SICUREZZA  
GANCHO VENTOSA ENCERRAMENTO SEGURANÇA

**Bricofan**



Ref	∅	↓	📦	📊	📄
6100 1397A	59 mm	1	12	2,01	✓
6100 1398A	77 mm	1	12	3,07	✓



EXPOSITOR RECOMENDADO / PRESENTOIR RECOMMANDÉ / RECOMMENDED DISPLAY / ESPOSITORE RACCOMANDATO / EXPOSITOR RECOMENDADO

Contenido 420 bl + display  
Content 420 bl + display



Ref			
0450 2500	430 x 800 mm	1	546,00

ES Creación de espacios personalizados de venta (fijación, tornillería, etc.). Expositores con productos de alta rotación.  
FR Creation d'espaces de vente personnalisés (fixation, visserie, etc.). Présentoirs pour articles a forte rotation.  
EN Your own sales place (fixing, bolts, etc.). Rotational products displays.  
IT Creazione di spazi personalizzati di vendita (fissaggio, viteria, ecc). Espositori con prodotti di elevata rotazione.  
PT Criação de espaços personalizados para venda (fixação, parafusos, etc.). Expositores com produtos de alta rotação.

	Ref				Ref		
	0106 1425A	14 x 25	12		0770 0640A	M-6 x 40	10
	0106 1630A	16 x 30	12		0770 0860A	M-8 x 60	10
	0106 1740A	17 x 40	12		0126 0640A	6 x 40	10
	0107 1425A	14 x 25	12		0126 0650A	6 x 50	10
	0107 1630A	16 x 30	12		0126 0860A	8 x 60	10
	0107 1740A	17 x 40	12		0032 0004A	M-4	12
	0108 1425A	14 x 25	12		0032 0006A	M-6	12
	0108 1630A	16 x 30	12		0032 0008A	M-8	12
	0108 1740A	17 x 40	12		0037 0004A	M-4	12
	0250 0325A	3 x 25	12		0037 0006A	M-6	12
	0250 0430A	4 x 30	12		0037 0008A	M-8	12
	0250 0540A	5 x 40	12		0052 0004A	M-4	12
	0760 0006A	M-6	12		0052 0006A	M-6	12
	0760 0008A	M-8	12		0052 0008A	M-8	12
	0760 0010A	M-10	12		0008 0430A	M-4 x 30	12
	0761 0005A	M-5	12		0008 0630A	M-6 x 30	12
	0761 0006A	M-6	12		0008 0640A	M-6 x 40	12
	0761 0008A	M-8	12		0008 0850A	M-8 x 50	10
	0761 0008A	M-8	12				

EXPOSITOR RECOMENDADO / PRESENTOIR RECOMMANDÉ / RECOMMENDED DISPLAY / ESPOSITORE RACCOMANDATO / EXPOSITOR RECOMENDADO

Contenido 906 bl + display  
Content 906 bl + display



Ref			
0450 2501	600 x 1960 mm	1	1185,60

	Ref				Ref		
	0106 1425A	14 x 25	12		0126 0640A	6 x 40	10
	0106 1630A	16 x 30	12		0126 0650A	6 x 50	10
	0106 1740A	17 x 40	12		0126 0660A	6 x 60	10
	0106 1850A	18 x 50	12		0126 0850A	8 x 50	10
	0106 1960A	19 x 60	12		0126 0860A	8 x 60	10
	0106 2050A	20 x 50	12		0126 0870A	8 x 70	10
	0107 1425A	14 x 25	12		0032 0004A	M-4	12
	0107 1630A	16 x 30	12		0032 0005A	M-5	12
	0107 1740A	17 x 40	12		0032 0006A	M-6	12
	0107 1850A	18 x 50	12		0032 0008A	M-8	12
	0107 1960A	19 x 60	12		0032 0010A	M-10	12
	0107 2050A	20 x 50	10		0037 0004A	M-4	12
	0108 1425A	14 x 25	12		0037 0005A	M-5	12
	0108 1630A	16 x 30	12		0037 0006A	M-6	12
	0108 1740A	17 x 40	12		0037 0008A	M-8	12
	0108 1850A	18 x 50	12		0037 0010A	M-10	12
	0108 1960A	19 x 60	12		0052 0004A	M-4	12
	0108 2050A	20 x 50	10		0052 0005A	M-5	12
	0250 0316A	3 x 15	12		0052 0006A	M-6	12
	0250 0325A	3 x 25	12		0052 0008A	M-8	12
	0250 3516A	3,5 x 15	12		0052 0010A	M-10	12
	0250 3525A	3,5 x 25	12		0053 0412A	M-4	12
	0250 0420A	4 x 20	12		0053 0515A	M-5	12
	0250 0430A	4 x 30	12		0053 0618A	M-6	12
	0250 0530A	5 x 30	12		0053 1030A	M-8	12
	0250 0540A	5 x 40	12		0053 1236A	M-10	12
	0250 0650A	6 x 50	12		0057 0004A	M-4	12
	0250 0660A	6 x 60	12		0057 0005A	M-5	12
	0760 0006A	M-6	12		0057 0006A	M-6	12
	0760 0008A	M-8	12		0057 0008A	M-8	12
	0760 0010A	M-10	12		0057 0010A	M-10	12
	0761 0005A	M-5	12		0008 0430A	M-4 x 30	12
	0761 0006A	M-6	12		0008 0530A	M-5 x 30	12
	0761 0008A	M-8	12		0008 0540A	M-5 x 40	12
	0761 0010A	M-10	10		0008 0630A	M-6 x 30	12
	0770 0640A	M-6 x 40	10		0008 0640A	M-6 x 40	12
	0770 0660A	M-6 x 60	10		0008 0650A	M-6 x 50	12
	0770 0860A	M-8 x 60	10		0008 0850A	M-8 x 50	10
	0770 0880A	M-8 x 80	10		0008 0860A	M-8 x 60	10



EXPOSITORES / PRÉSENTOIRS / DISPLAY STANDS / ESPOSITORI / EXPOSITORES

Sólo expositor  
Only display



Ref			
EXPOSITOR17	85 x 27,50 x 46 mm	1	120,96

Sólo expositor  
Only display



Ref			
EXPOSITOR18	500 x 1960 mm	1	266,41

Sólo expositor  
Only display



Ref			
EXPOSITOR4	600 x 1680 mm	1	278,88



Ref		
EXPOSITOR 10	1	2,02

Ref		
EXPOSITOR 21	1	1,73

Sólo expositor  
Only display



Ref			
EXPOSITOR8	500 x 1670 mm	1	289,50

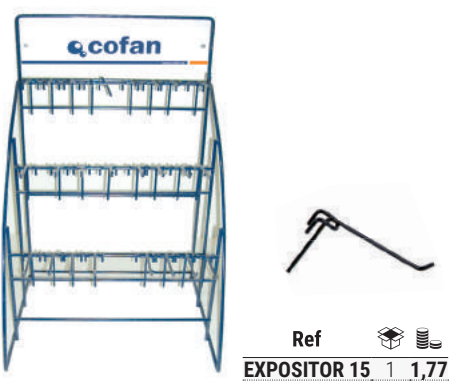

Ref		
EXPOSITOR 15	1	1,77

Ref			
EXPOSITOR5	430 x 800 mm	1	80,85

Ref			
EXPOSITOR6	340 x 580 mm	1	71,70

Sólo expositor  
Only display



Ref			
EXPOSITOR3	310 x 540 mm	1	98,40

Sólo expositor  
Only display



Ref			
EXPOSITOR16	370 x 460 mm	1	104,00

Sólo expositor  
Only display



Ref		
0951 9999	1	121,50





Ref		
EXPOSITOR29	1	26,10

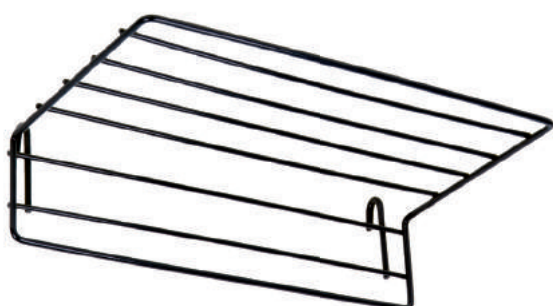

Ref		
EXPOSITOR20	1	19,50

Sólo expositor  
Only display



Ref			
EXPOSITOR19	1000 x 400 x 1600 mm	1	297,28

Incluye / Included



Ref	
EXPOSITOR 10	20

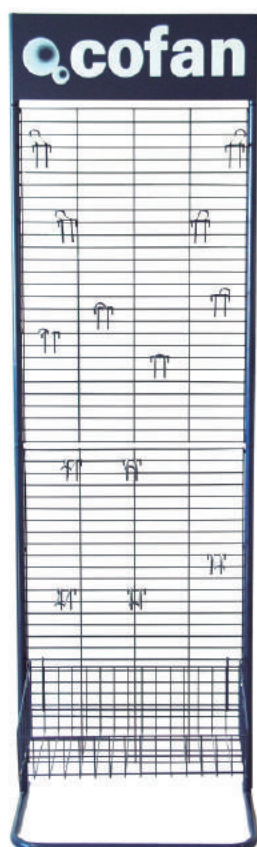

Ref			
EXPOSITOR11	600 x 1960 mm	1	335,50

TIRAS PLÁSTICO PARA BLÍSTER / BANDES PLASTIQUE POUR BLISTER  
PLASTIC HANG STRIPS FOR BLISTER / STRISCE PORTA BLISTER IN PLASTICA  
TIRAS DE PLÁSTICO PARA PENDURAR BLISTER

Sólo tiras  
Only hang strips



ES Tiras de plástico diseñadas para colgar productos en blíster y diseñar sus propios espacios de exposición.

FR Bandes plastique conçues pour accrocher des produits en blister et concevoir ses propres espaces d'exposition.

EN Plastic hang strips designed to hang products packed in blisters and create your own exhibition areas.

IT Strisce in plastica adatte per esporre confezioni blister e progettare i propri spazi espositivi.

PT Tiras de plástico desenhadas para pendurar produtos em blister e projetar os seus próprios espaços de exposição.

Ref			
BLISTER15	663 x 41 mm	1	1,40



EXPOSITOR VARILLA ROSCADA 12 COMPARTIMENTOS  
 PRÉSENTOIR TIGE FILETÉE BLANC  
 WHITE DISPLAY FOR THREADED ROD  
 ESPOSITORE BARRA FILETTATA BIANCO  
 EXPOSITOR BRANCO VARA DE ENROSCAR

Sólo expositor

Only display



Ref				
EXPOSITOR28	653 x 490 x 290 mm	1	224,90	

EXPOSITOR DE ZAPATOS  
 PRÉSENTOIR DE CHAUSSURE  
 SHOES DISPLAY STAND  
 ESPOSITORE PER SCARPE  
 EXPOSITOR DE SAPATOS



Ref				
EXPOSITOR31	40 x 20 x 70 mm	1	194,50	

EXPOSITOR GAFAS POLARIZADAS Y GRADUADAS  
 PRESENTOIR LUNETTES POLARISÉES ET GRADUÉES  
 DISPLAY STAND FOR POLARISED AND PRESCRIPTION GLASSES  
 ESPOSITORE OCCHIALI POLARIZZATI E GRADUATI  
 EXPOSITOR DE ÓCULOS POLARIZADOS E GRADUADOS



Ref				
EXPOSITOR25	590 x 160 x 170 mm	1	92,50	

EXPOSITOR ABRAZADERAS VACÍO PARA 9MM  
 PRESENTOIR VIDE POUR COLLIERIS 9MM  
 EMPTY DISPLAY STAND FOR 9MM HOSE CLAMPS  
 ESPOSITORE VUOTO PER FASCETTE 9MM  
 EXPOSITOR VAZIO P/ ABRAÇADEIRAS 9MM

30-45	25-40	32-50	20-32	16-25	12-20	10-16	8-12
70-90		70-80		50-70		40-60	



Ref	A	B	C		
0450 0005	370 mm	390 mm	130 mm	1	70,98

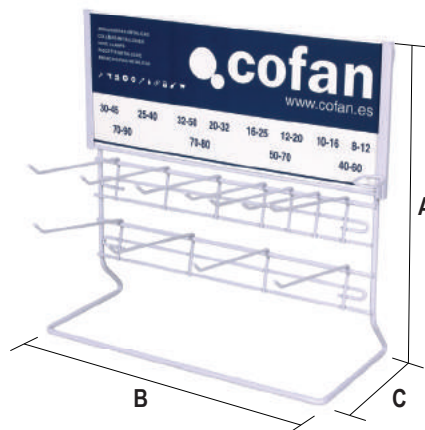

Ref	A	B	C		
0801 7999	340 mm	370 mm	200 mm	1	30,16





GAVETAS / CASIER / STORAGE / CASSETTO / ARMAZENAGEM



<b>Ref</b>			
<b>CA87</b>	400 x 100 x 156 mm	1	<b>1,66</b>



<b>Ref</b>			
<b>CA88</b>	400 x 200 x 156 mm	1	<b>2,40</b>

Separador



<b>Ref</b>			
<b>CA99</b>	382 x 300 mm	1	<b>0,54</b>

Gaveta



<b>Ref</b>			
<b>CA98</b>	567 x 382 x 300 mm	1	<b>5,25</b>

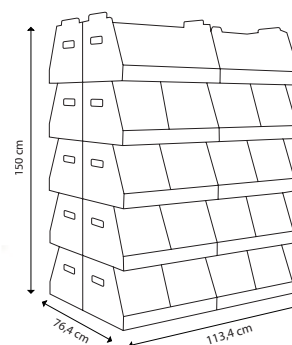
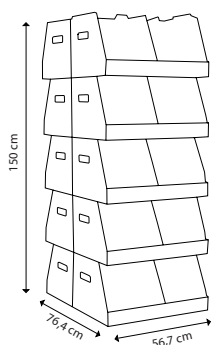



EXPOSITOR PERFORADO / PRESENTOIR PERFORÉ / PEGBOARD DISPLAY STAND / ESPOSITORE FORATO / EXPOSITOR PERFURADO

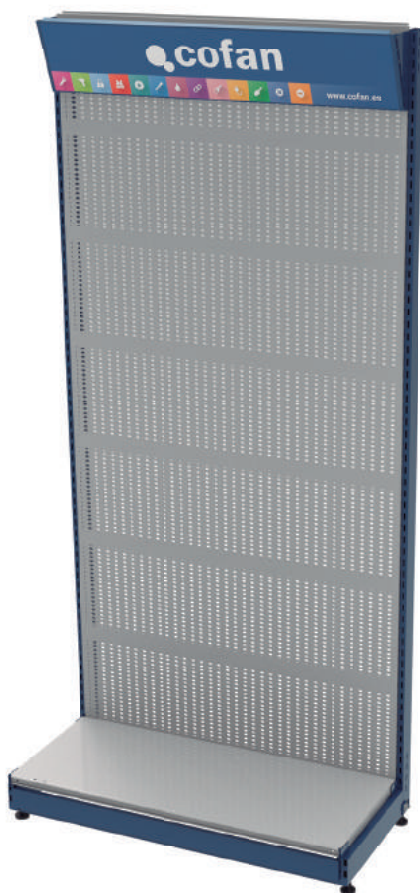

Ref			
2100 1101	2200 x 1030 x 460 mm	1	332,10

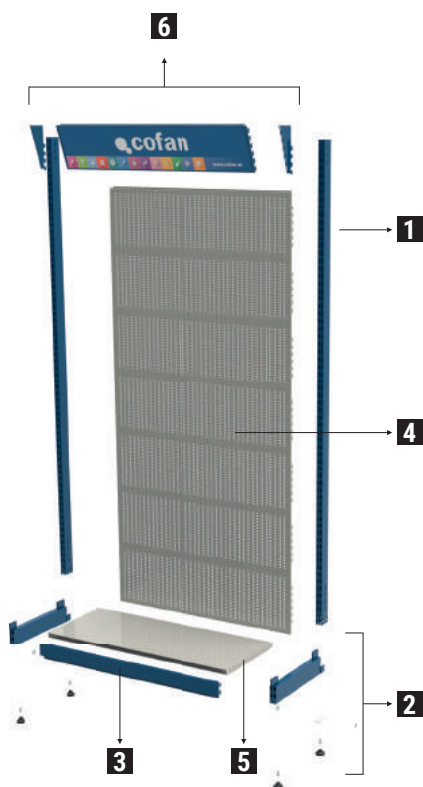

COLUMNA LATERAL / COLONNE LATÉRALE  
LATERAL UPRIGHT / COLONNA LATERALE  
COLUMA LATERAL

**1**

Ref			
2100 1101.01	2250 x 60 x 30 mm	1	37,50

FONDO PERFORADO / FONDS PERFORÉ  
PEGBOARD BACKPANEL / PANNELLO FORATO  
FUNDO PERFURADO

**4**

Ref			
2100 1101.04	300 x 1000 mm	1	24,05

PIE LATERAL / PIED LATÉRAL  
LATERAL BASE END COVER / BASE LATERAL  
PÉ LATERAL

**2**

Ref			
2100 1101.02	400 mm	1	14,61

BANDEJA INFERIOR / PLATEAU INFÉRIEUR  
PLATEAU INFÉRIEUR / RIPIANO INFERIORE  
PRATELEIRA INFERIOR

**5**

Ref			
2100 1101.05	400 x 1000 mm	1	38,58

FALDÓN DELANTERO LAMA BAJA  
PLAQUE DE PROTECTION / KICKPLATE  
BASE ANTERIORE / FAIXA FRONTAL LÂMINA  
BAIXA

**3**

Ref			
2100 1101.03	1000 mm	1	5,25

CARTELA / CARTELA / TOP PANEL  
PANNELLO / CARTAZ

**6**

Ref			
2100 1101.06	200 x 1000 mm	1	65,60



EXPOSITOR GÓNDOLA / PRESENTOIR GONDOLA / GONDOLA DISPLAY / ESPOSITORE GONDOLA / EXPOSITOR GÓNDOLA



Ref			
2100 1102	1600 x 1030 x 860 mm	1	405,41



COLUMNA LATERAL / COLONNE LATÉRALE  
LATERAL UPRIGHT / COLONNA LATERALE  
COLUMA LATERAL

1	Ref			
	2100 1102.01	1600 x 60 x 30 mm	1	26,09

BANDEJA INFERIOR / PLATEAU INFÉRIEUR  
PLATEAU INFÉRIEUR / RIPIANO INFERIORE  
PRATELEIRA INFERIOR

5	Ref			
	2100 1102.05	400 x 1000 mm	1	38,58

PIE LATERAL / PIED LATÉRAL  
LATERAL BASE END COVER / BASE LATERAL  
PÉ LATERAL

2	Ref			
	2100 1102.02	400 mm	1	14,61

CARTELA / CARTELA / TOP PANEL  
PANNELLO / CARTAZ

6	Ref			
	2100 1102.06	300 x 1000 mm	1	37,80

FALDÓN DELANTERO LAMA BAJA  
PLAQUE DE PROTECTION / KICKPLATE  
BASE ANTERIORE / FAIXA FRONTAL LÂMINA BAIXA

3	Ref			
	2100 1102.03	1000 mm	1	5,25

TAPAJUNTAS / SOLIN / CORNER JOINT /  
COPRIGIUNTO / TAPA-JUNTAS

7	Ref			
	2100 1102.17	1000 mm	1	10,70

FONDO PERFORADO / FONDS PERFORÉ  
PEGBOARD BACKPANEL / PANNELLO FORATO  
FUNDO PERFURADO

4	Ref			
	2100 1102.04	300 x 1000 mm	1	24,05

TAPÓN / COUVERCLE / COVER /  
COPERCHIO / TAMPA

8	Ref		
	2100 1102.18	1	2,40





EXPOSITOR RINCÓN MURAL / PRESENTOIR D'ANGLE MURAL / WALL CORNER GONDOLA SHELVING  
 ESPOSITORE ANGOLARE / EXPOSITOR CANTO PAREDE



Ref			
2100 1103	2200 x 460 x 1030 mm	1	251,33

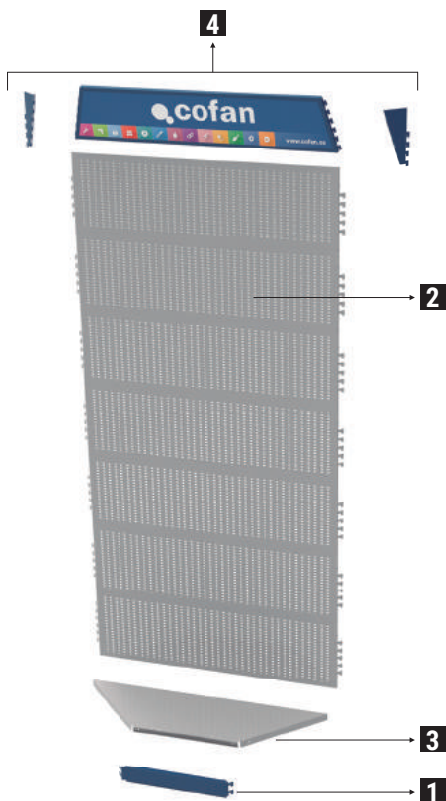

**1**  
 FALDÓN DELANTERO LAMA BAJA  
 PLAQUE DE PROTECTION / KICKPLATE  
 BASE ANTERIORE / FAIXA FRONTAL LÂMINA BAIXA

Ref	↔		
2100 1103.01	200 mm	1	5,54

**3**  
 BANDEJA RINCONERA / PLATEAU D'ANGLE  
 CORNER SHELF / PANNELLO ANGOLARE  
 PRATELEIRA ESQUINADA

Ref			
2100 1103.03	400 x 1000 mm	1	41,33

**2**  
 FONDO PERFORADO / FONDS PERFORÉ  
 PEGBOARD BACKPANEL / PANNELLO FORATO  
 FUNDO PERFURADO

Ref			
2100 1103.02	300 x 1000 mm	1	20,91

**4**  
 CARTELA / CARTELA / TOP PANEL  
 PANNELLO / CARTAZ

Ref			
2100 1103.04	200 x 1000 mm	1	58,10



EXPOSITOR VERTICAL PERFORADO / PRÉSENTOIR VERTICAL PERFORÉ  
VERTICAL PEGBOARD DISPLAY STAND / ESPOSITORE VERTICALE FORATO  
EXPOSITOR VERTICAL PERFURADO

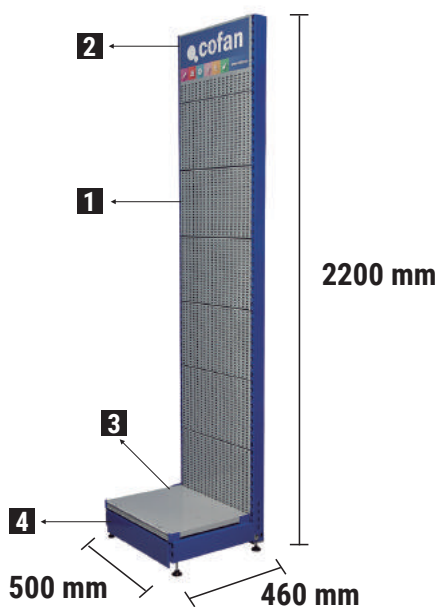

Ref	Icon	Dimensions	Price
2100 1127		2200 x 500 x 460 mm	240,26

FONDO PERFORADO / FONDS PERFORÉ / PEGBOARD BACKPANEL  
PANNELLO FORATO / FUNDO PERFURADO

1	Ref	Icon	Dimensions	Price
	2100 1127.01		500 x 300 mm	16,40

CARTELA / CARTELA / TOP PANEL / PANNELLO / CARTAZ

2	Ref	Icon	Dimensions	Price
	2100 1127.02		500 x 200 mm	50,85

BANDEJA INFERIOR / PLATEAU INFÉRIEUR / PLATEAU INFÉRIEUR  
RIPIANO INFERIORE / PRATELEIRA INFERIOR

3	Ref	Icon	Dimensions	Price
	2100 1127.03		400 x 500 mm	16,80

FALDÓN DELANTERO LAMA BAJA / PLAQUE DE PROTECTION / KICKPLATE  
BASE ANTERIORE / FAIXA FRONTAL LÂMINA BAIXA

4	Ref	Icon	Dimensions	Price
	2100 1127.04		300 x 500 mm	4,20

CARTELA / CARTELA / TOP PANEL / PANNELLO / CARTAZ



Ref	Icon	Dimensions	Price
2100 1127.02		500 x 200 mm	50,85

BANDEJA PARA EXPOSITOR / PLATEAU POUR PRESENTOIR  
SHELF TRAY FOR DISPLAY STANDS / RIPIANO PER ESPOSITORI  
PRATELEIRA PARA EXPOSITOR

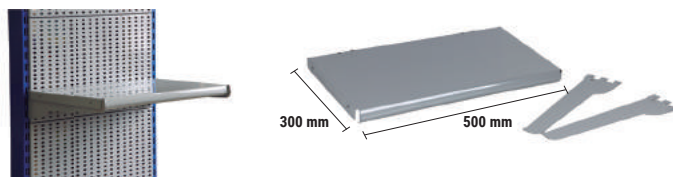

Ref	Icon	Dimensions	Price
2100 1128		500 x 300 mm	23,04

PROLONGADOR DE COLUMNA / EXTENSION DE COLONNE / EXTENDIBLE PALLET RACKING UPRIGHTS  
MONTANTE ESTENDIBILE PER SCAFFALE / EXTENSÃO DA COLUNA

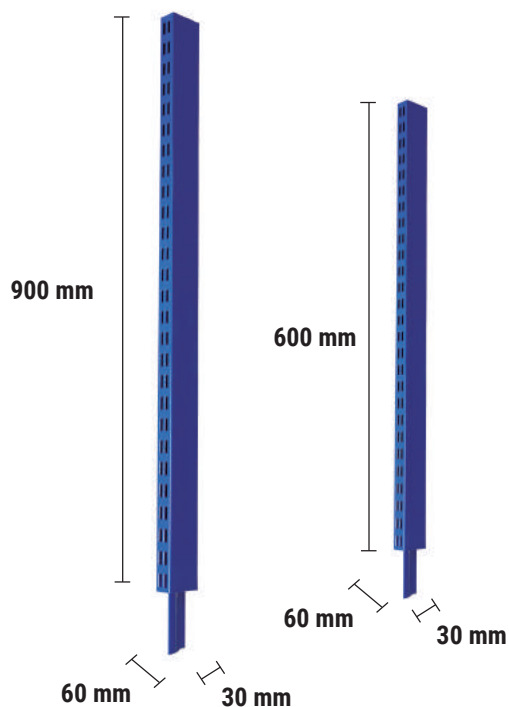

Ref	Icon	Dimensions	Price
2100 1219		900 x 60 x 30 mm	29,90
2100 1220		600 x 60 x 30 mm	27,06



SEÑALÉTICA IMANTADA PARA EXPOSITOR / SIGNALÉTIQUE AIMANTÉE POUR PRÉSENTOIR / SINALIZAÇÃO MAGNETIZADA PARA EXPOSITORES  
 SEGNALETICA MAGNETICA PER ESPOSITORE / SINALIZAÇÃO MAGNETIZADA PARA EXPOSITORES



**ENGRASE Y AUTOMOCIÓN**

**LUBRIFICAÇÃO E AUTO**

Ref	975 x 195 mm	1	22,14
2100 1131K	975 x 195 mm	1	22,14
2100 1131K-P	975 x 195 mm	1	22,14

**ELECTRICIDAD**

**ELECTRICIDADE**

Ref	975 x 195 mm	1	22,14
2100 1131N	975 x 195 mm	1	22,14
2100 1131N-P	975 x 195 mm	1	22,14

**HERRAMIENTA**

**FERRAMENTA**

Ref	975 x 195 mm	1	22,14
2100 1131A	975 x 195 mm	1	22,14
2100 1131A-P	975 x 195 mm	1	22,14

**SEGURIDAD**

**SEGURANÇA**

Ref	975 x 195 mm	1	22,14
2100 1131C	975 x 195 mm	1	22,14
2100 1131C-P	975 x 195 mm	1	22,14

**ABRASIVO, CORTE Y TALADRO**

**ABRASIVO, CORTE E PERFURAÇÃO**

Ref	975 x 195 mm	1	22,14
2100 1131D	975 x 195 mm	1	22,14
2100 1131D-P	975 x 195 mm	1	22,14

**CABLE, CADENA Y CORDELERÍA**

**CABO, CORRENTE E CORDAS**

Ref	975 x 195 mm	1	22,14
2100 1131E	975 x 195 mm	1	22,14
2100 1131E-P	975 x 195 mm	1	22,14

**FIJACIÓN**

**FIXAÇÃO**

Ref	975 x 195 mm	1	22,14
2100 1131M	975 x 195 mm	1	22,14
2100 1131M-P	975 x 195 mm	1	22,14

**ILUMINACIÓN**

**ILUMINAÇÃO**

Ref	975 x 195 mm	1	22,14
2100 1131G	975 x 195 mm	1	22,14
2100 1131G-P	975 x 195 mm	1	22,14

**HERRAMIENTA ELECTRICA**

**FERRAMENTA ELÉTRICA**

Ref	975 x 195 mm	1	22,14
2100 1131B	975 x 195 mm	1	22,14
2100 1131B-P	975 x 195 mm	1	22,14

**JARDINERÍA**

**JARDIM**

Ref	975 x 195 mm	1	22,14
2100 1131H	975 x 195 mm	1	22,14
2100 1131H-P	975 x 195 mm	1	22,14

**CERRAJERÍA**

**SERRALHARIA**

Ref	975 x 195 mm	1	22,14
2100 1131L	975 x 195 mm	1	22,14
2100 1131L-P	975 x 195 mm	1	22,14

**cofan home**

Ref	975 x 200 mm	1	22,14
2100 1131J	975 x 200 mm	1	22,14

**TORNILLERÍA**

Ref	975 x 195 mm	1	22,14
2100 1131I	975 x 195 mm	1	22,14

**PINTURA**

Ref	975 x 195 mm	1	22,14
2100 1131F	975 x 195 mm	1	22,14



PACK 2 CREMALLERAS PARED PARA ESTANTERIAS / PACK 2 CREMAILLERES MURALES POUR ÉTAGÈRES / PACK OF 2 TWIN SLOT UPRIGHTS  
 CONFEZIONE DI 2 MONTANTI PER SCAFFALATURE A MURO / PACK 2 BASTIDORES DE PARED PARA ESTANTES

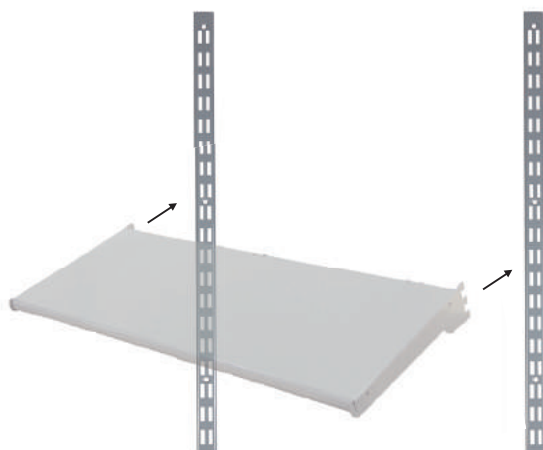
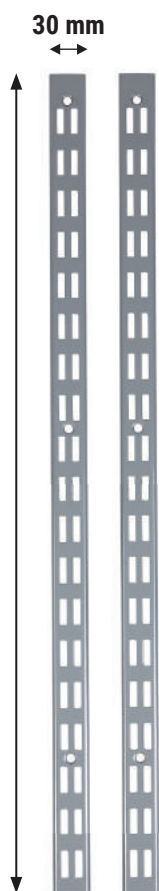

Apto para / Convient pour / Suitable for / Adatto per / Apto para:

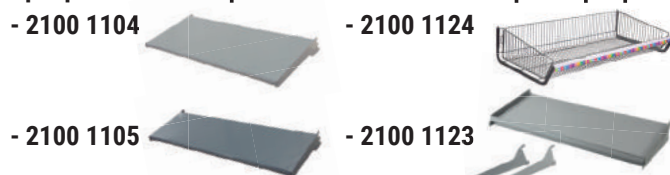

Ref	Dimensions	Qty	x pack
2100 1104	1080 x 30 x 25 mm	1	27,65
2100 1105	1608 x 30 x 25 mm	1	39,40
2100 1123	2136 x 30 x 25 mm	1	52,20
2100 1124	2400 x 30 x 25 mm	1	58,60

CESTO CON EXTREMOS PARA EXPOSITOR + PORTAPRECIOS / PANIER AVEC EXTREMITES POUR PRESENTOIR + SUPPORT PRIX  
 BASKET WITH ENDS FOR DISPLAY + PRICE HOLDER / CESTELLO CON ESTREMI PER ESPOSITORE + PORTAPREZZI  
 CESTO COM EXTREMOS PARA EXPOSITOR + PORTAPREÇOS



PORTAPRECIOS INCLUIDO

Ref	Dimensions	Qty	Price
2100 1124	1000 x 480 mm	2	110,99

SEPARADOR PARA CESTO EXPOSITOR / SÉPARATEUR POUR PANIER / DIVIDER FOR THE DISPLAY STAND BASKET  
 SEPARATORE PER CESTELLO / SEPARADOR PARA CESTO

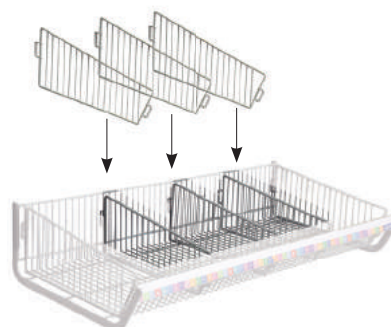

Ref	Qty	Price
2100 1125	1	10,45





CONJUNTO BANDEJA / ENSEMBLE PLATEAU / SHELF KIT / RIPIANO / CONJUNTO PRATELEIRA

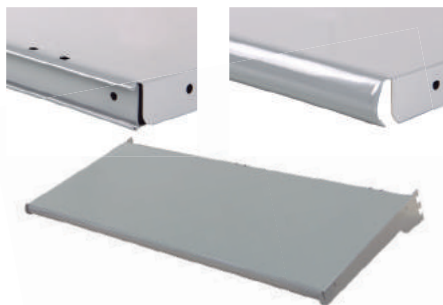

**REVERSIBLE**

Perfil para portaprecios y perfil redondeado.

Ref			
<b>2100 1104</b>	1000 x 400 mm	2	<b>46,91</b>
<b>2100 1105</b>	1000 x 300 mm	2	<b>39,86</b>



BANDEJA ESPECIAL INCLINADA CON SOPORTES / PLATEAU SPÉCIAL INCLINÉ AVEC SUPPORTS / SPECIAL SLOPING SHELF WITH BRACKETS  
RIPIANO SPECIALE INCLINATO CON SUPPORTI / PRATELEIRA ESPECIAL INCLINADA COM SUPORTES

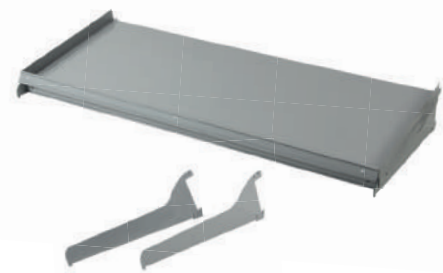

Ref			
<b>2100 1123</b>	1000 x 400 mm	1	<b>73,95</b>



PORTAPRECIOS CON TIRA PARA BANDEJA / SUPPORT DE PRIX AVEC BANDE POUR PLATEAU / PRICE HOLDER WITH SHELF STRIP  
PORTAPREZZI CON STRISCIA PER RIPIANO / PORTA PREÇOS COM FAIXA PARA PRATELEIRA



Ref			
<b>2100 1106</b>	1000 x 39 mm	1	<b>7,59</b>



CESTA 5 HUECOS PARA EXPOSITORES / PANIER 5 DIVISEURS POUR PRESENTOIR / WIRE BASKET WITH 5 DIVIDERS FOR DISPLAYS  
CESTELLO A 5 DIVISORI PER ESPOSITORI / CESTO 5 ESPAÇOS PARA EXPOSITORES



Ref			
<b>2100 1108</b>	1000 x 400 mm	1	<b>70,52</b>



BANDEJA ANGULAR + 18 SEPARADORES / PLATEAU ANGULAIRE PRESENT. + 18 SEPARATEURS / ANGLED SHELF FOR DISPLAY + 18 DIVIDERS  
RIPIANO ANGOLARE PER ESPOSITORI + 18 DIVISORI / PRATELEIRA ANGULAR EXPO. + 18 SEPARAD.



Ref			
<b>2100 1109</b>	1000 x 300 mm	1	<b>103,32</b>





BARRA DE CARGA / BARRE DE CHARGE / LOAD BAR / BARRA DI CARICO / BARRA



Ref			
2100 1111	1000 x 40 x 20 mm	1	23,05

COLGADOR UNIVERSAL DISCOS Y HERRAMIENTAS (PARA BARRA DE CARGA) / BRAS UNIVERSEL POUR DISQUES ET OUTILS  
UNIVERSAL ARM FOR DISCS AND TOOLS / BRACCIO UNIVERSALE PER DISCHI E ATTREZZATURE  
CABIDE UNIVERSAL DISCOS E FERRAMENTAS (PARA BARRA)

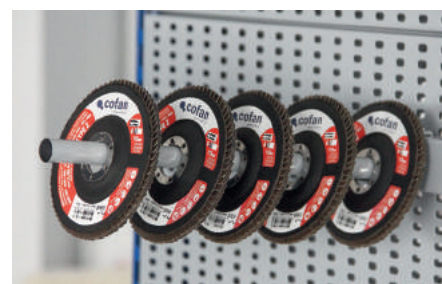

Ref			
2100 1114	300 mm	1	8,61

PERCHA RECTA OVALADA DE TUBO (PARA BARRA DE CARGA) / PERCHE DROITE OVALE DE TUBE / STRAIGHT ARM OVAL TUBE  
BRACCIO / CABIDE RECTO OVALDO DE TUBO



Ref			
2100 1112	400 mm	1	5,42

PERCHA INCLINADA OVALADA CON PIVOTES (PARA BARRA DE CARGA) / TUBE OVALE BRAS OSCILLANT AVEC PIVOTS  
SLOPING ARM OVAL TUBE WITH BALLS / BRACCIO INCLINATO OVALE CON PERNI / CABIDE RECTO OVALDO DE TUBO

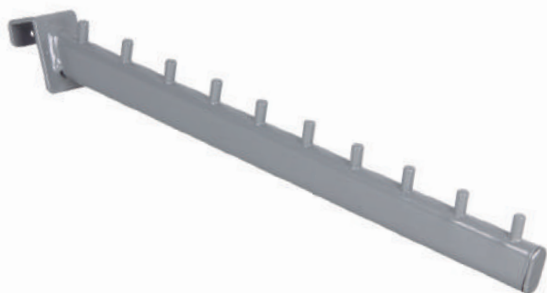

Ref			
2100 1113	400 mm	1	8,90





BARRA DE CARGA CON 10 GANCHOS (10 cm) / BARRE DE CHARGE AVEC 10 CROCHETS (10 cm) / LOAD BAR WITH 10 HOOKS (10 cm)  
 BARRA DI CARICO CON 10 GANCI (10 cm) / BARRA COM 10 GANCHOS (10 cm)

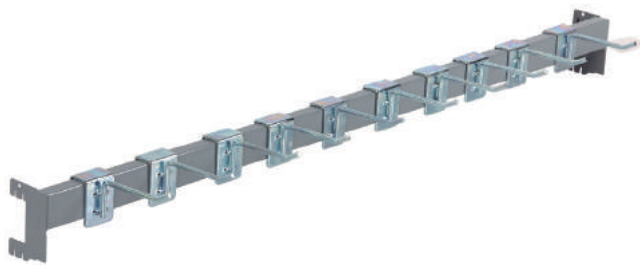

Ref			
2100 1110	1000 x 40 x 20 mm	1	47,63

SOPORTE CALZADO A FONDO PERFORADO / SUPPORT CHAUSSURE À FOND PERFORÉ / FOOTWEAR HOLDER PEGBOARD BACK PANEL  
 RIPIANO PER SCARPE PER FONDO FORATO / SUPORTE CALÇADO FUNDO PERFURADO



Ref			
2100 1115	290 x 130 mm	1	13,12

GANCHO SIMPLE CON ETIQUETERO / CROCHET SIMPLE AVEC SUPPORT ETIQUETTE / SIMPLE HOOK WITH PRICE TICKET HOLDER  
 GANCIO SEMPLICE CON PORTA ETICHETTA / GANCHO SIMPLIS COM ETIQUETA



Ref				
2100 1116	200 x 6 mm	1	50	2,34

GANCHO SIMPLE / CROCHET SIMPLE / SIMPLE HOOK / GANCIO SEMPLICE / GANCHO SIMPLIS



Ref				
2100 1117	100 x Ø6 mm	1	50	0,99
2100 1118	200 x Ø6 mm	1	50	1,52





GANCHO BLÍSTER DOBLE / CROCHET BLISTER DOUBLE / HOOK FOR DOUBLE BLISTER  
 GANCIO DOPPIO PER BLISTER / GANCHO BLISTER DUPLO



Ref			
2100 1119	150 x Ø5 mm	1	1,73
2100 1120	250 x Ø5 mm	1	2,26

CONJUNTO TUBO PARA HULES Y ROLLOS 1000 MM / TUBE POUR TOILES CIREES ET ROULEAUX 1000 MM / TUBE KIT FOR OILCLOTHS AND ROLLS 1000MM  
 TUBE POUR TOILES CIREES ET ROULEAUX 1000 MM / CONJUNTO TUBO PARA ROLOS 1000 MM



Ref			
2100 1121	1000 x Ø30 mm	1	30,25
2100 1129	1000 x Ø20 mm	1	30,25

CONJUNTO TUBO PARA HULES Y ROLLOS 2 METROS / TUBE POUR TOILES CIREES ET ROULEAUX 2000 MM / TUBE KIT FOR OILCLOTHS AND ROLLS 2000 MM  
 TUBO PER TELE CERATE E ROTOLI 2000MM / CONJUNTO TUBO P/ ROLLOS 2000 MM



Ref			
2100 1122	2000 x Ø30 mm	1	46,20



MOSTRADOR MODULAR / PRESENTOIR MODULAIRE / MODULAR COUNTER / ESPOSITORE MODULARE / MOSTRADOR MODULAR

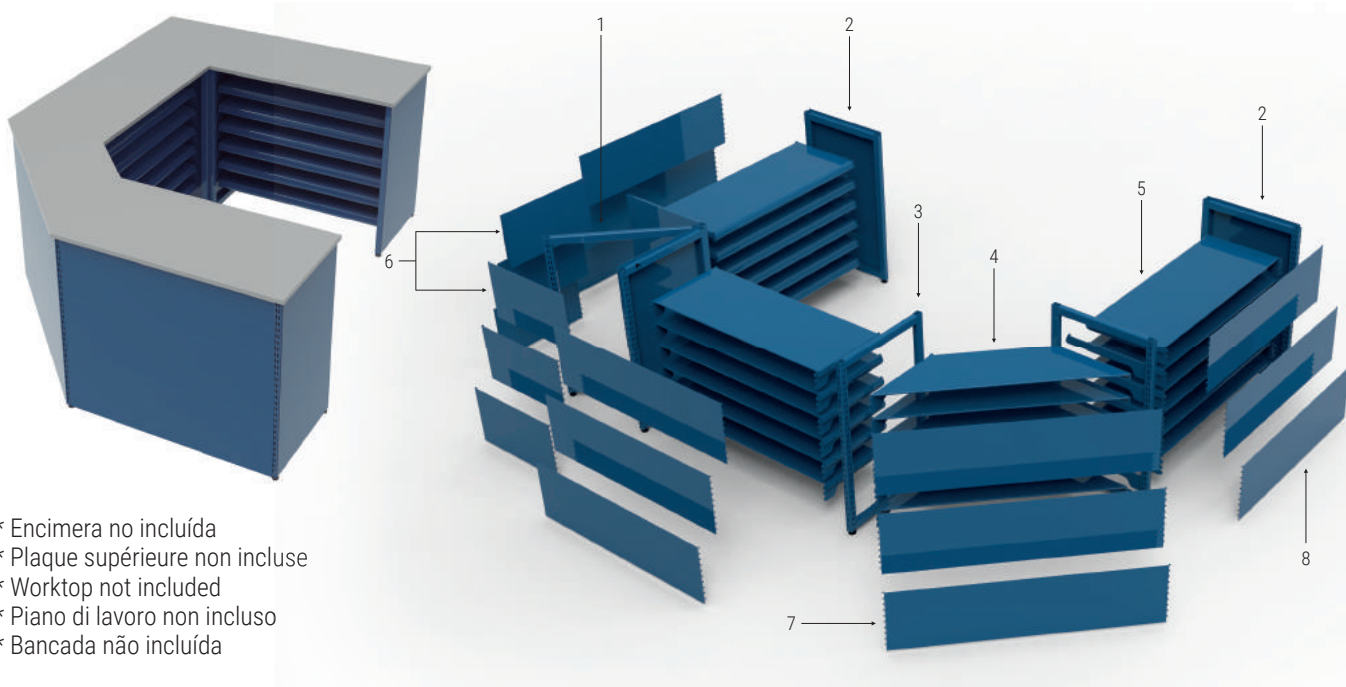

- \* Encimera no incluída
- \* Plaque supérieure non incluse
- \* Worktop not included
- \* Piano di lavoro non incluso
- \* Bancada não incluída

MARCO MOSTRADOR TRIPLE PARA ÁNGULO RECTO (RINCÓN 90°) / CADRE PRESENTOIR TRIPLE POUR ANGLE DROIT (ANGLE 90°)  
TRIPLE COUNTER FRAME FOR STRAIGHT ANGLE (90° CORNER) / STRUTTURA TRIPLA ESPOSITORE PER ANGOLO RETTO (ANGOLO 90°)  
MARCO MOSTRADOR TRIPLO PARA ÂNGULO RECTO (ESQUINA 90°)

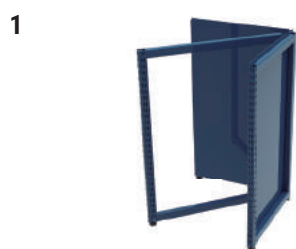

Ref			
<b>8900 9002</b>	525 x 525 x 920 mm	1	<b>467,40</b>

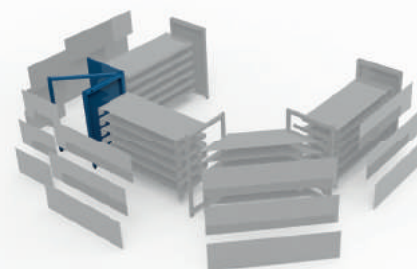

MARCO FINAL MOSTRADOR (IZQUIERDO O DERECHO) / CADRE PRESENTOIR (DROIT OU GAUCHE) / COUNTER FRAME (LEFT OR RIGHT)  
STRUTTURA LATERALE ESPOSITORE (SINISTRA O DESTRA) / MARCO MOSTRADOR (ESQUERDO OU DIREITO)



Ref			
<b>8900 9000</b>	525 x 920 mm	1	<b>224,70</b>

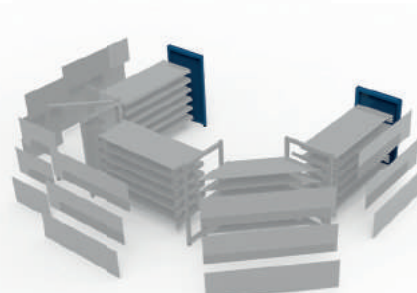

MARCO INTERMEDIO MOSTRADOR SENCILLO / CADRE SIMPLE POUR PRESENTOIR / COUNTER SIMPLE FRAME  
STRUTTURA SEMPLICE ESPOSITORE / MARCO MOSTRADOR SEMPLICES

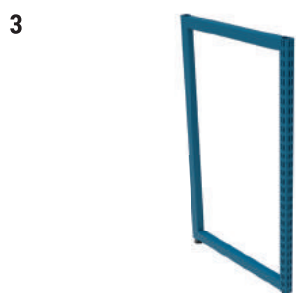

Ref			
<b>8900 9001</b>	520 x 920 mm	1	<b>190,50</b>

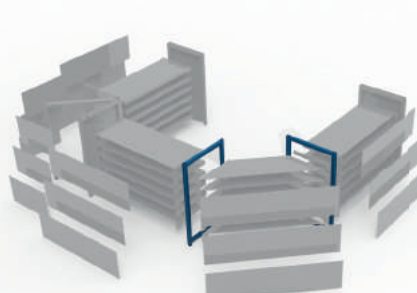



**BANDEJA RINCONERA CHAFLÁN 45° INT. + 2 CARTELAS / PLATEAU D'ANGLE CHANFREIN INT. 45° + 2 EQUERRES**  
**TRAY FOR INTERIOR 45° CORNER + 2 BRACKETS / RIPIANO ANGOLARE RACCORDATO 45° INTERNO + 2 SUPPORTI**  
**BANDEJA DE CANTO CHANFRO 45° INT. + 2 REFORÇOS**

**4**



Ref			
<b>8900 9011</b>	400 mm	1	<b>71,20</b>

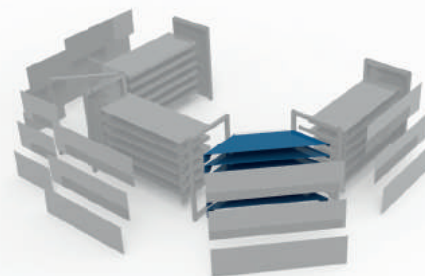

**BANDEJA + 2 CARTELAS / PLATEAU + 2 EQUERRES / TRAY + 2 BRACKETS / RIPIANO + 2 SUPPORTI / BANDEJA + 2 REFORÇOS**

**5**

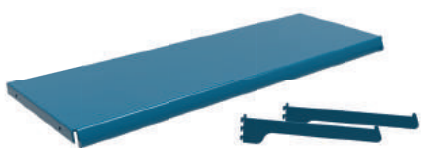

Ref			
<b>8900 9010</b>	1000 x 400 mm	1	<b>62,70</b>
<b>8900 9013</b>	500 x 400 mm	1	<b>42,90</b>

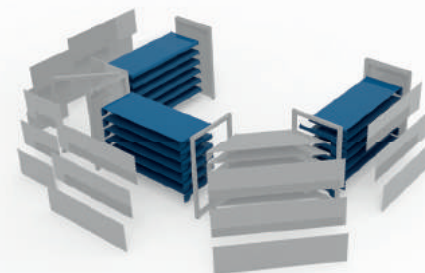

**FONDO LISO ÁNGULO RECTO DERECHO O IZQUIERDO (RINCÓN 90°) / FOND LISSE ANGLE DROIT GAUCHE OU DROITE (ANGLE 90°)**  
**PLAIN BACKGROUND STRAIGHT ANGLE LEFT OR RIGHT (90° CORNER) / PANNELLO PIANO ANGOLO RETTO DESTRO O SINISTRO (ANGOLO 90°)**  
**FUNDO LISO ÁNGULO RECTO DIREITO OU ESQUERDO (ESQUINA 90°)**

**6**



Ref			
<b>8900 9003</b>	550 x 300 mm	1	<b>18,60</b>

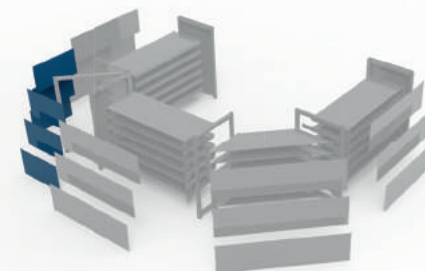

**FONDO LISO CHAFLÁN (RINCÓN 45°) / FOND LISSE CHANFREINE (ANGLE 45°) / PLAIN BACKGROUND (45° CORNER)**  
**PANNELLO PIANO ANGOLARE (ANGOLO 45°) / FUNDO LISO CHANFRO (ESQUINA 45°)**

**7**

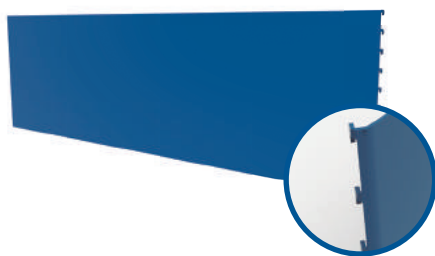

Ref			
<b>8900 9005</b>	1000 x 300 mm	1	<b>32,90</b>

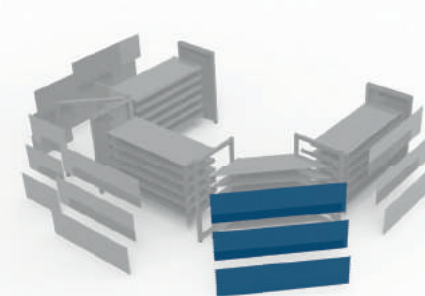

**FONDO LISO / FOND LISSE / PLAIN BACKGROUND / PANNELLO PIANO / FUNDO LISO**

**8**



Ref			
<b>8900 9004</b>	1000 x 300 mm	1	<b>32,90</b>
<b>8900 9006</b>	500 x 300 mm	1	<b>17,10</b>

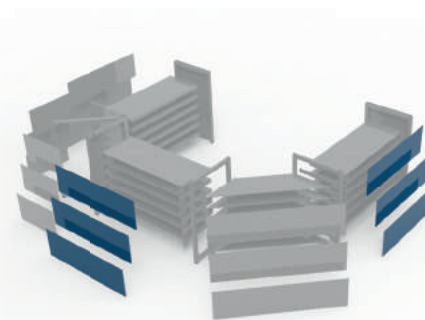



MANIQUÍ / MANNEQUIN / MANNEQUIN / MANICHINO / MANEQUIM

ES Hombre.  
FR Homme.  
EN Mannequin.  
IT Uomo.  
PT Homem.



ES Mujer.  
FR Femme.  
EN Female.  
IT Donna.  
PT Mulher.



ES Niño.  
FR Enfant.  
EN Child.  
IT Bambino.  
PT Criança.



Ref			Ref			Ref		
2100 1140	1	250,95	2100 1141	1	359,40	2100 1142	1	189,25

PUERTA DE ACCESO MECÁNICO / PORTE D'ACCÈS MÉCANIQUE / AUTOMATIC ENTRANCE GATE  
PORTELLI MECCANICO / PORTA DE ACESSO MECÂNICO

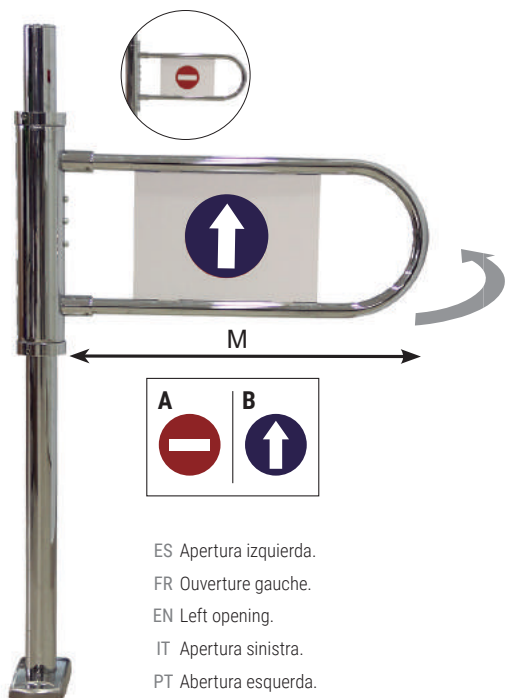

ES Apertura izquierda.  
FR Ouverture gauche.  
EN Left opening.  
IT Apertura sinistra.  
PT Abertura esquerda.

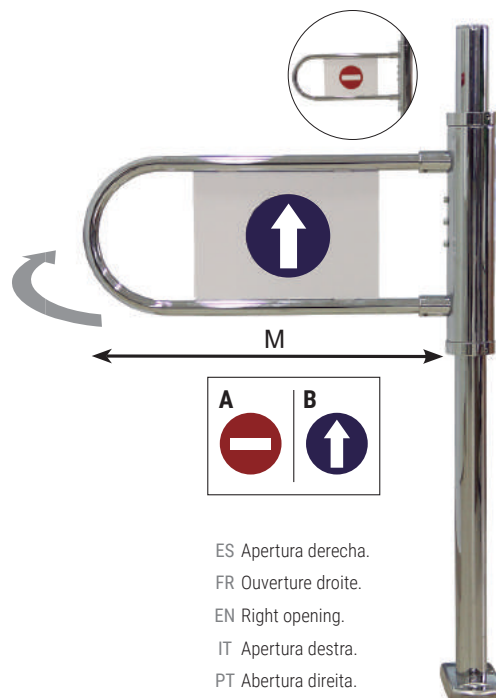

ES Apertura derecha.  
FR Ouverture droite.  
EN Right opening.  
IT Apertura destra.  
PT Abertura direita.

Ref	M			Ref	M		
2100 1150	600 mm	1	745,92	2100 1152	600 mm	1	745,92
2100 1151	800 mm	1	772,80	2100 1153	800 mm	1	772,80





DISPENSADOR DE BOLSAS PARA PARAGUAS SENC / DISPENSATEUR DE SACS POUR PARAPLUIES SENC / UMBRELLA BAG DISPENSER "SENC"  
 DISPENSER BUSTE PER OMBRELLI "SENC" / DISPENSADOR DE SACOS PARA GUARDA-CHUVAS SENC

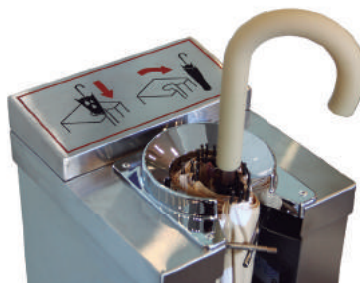

Ref		
2100 1154	1	469,77

PACK 100 BOLSAS GRANDES (PARA PARAGUAS SENC) / PACK 100 GRANDS SACS (POUR PARAPLUIE SENC)  
 100-PC LARGE BAGS (FOR UMBRELLAS "SENC") / CONFEZIONE 100 BUSTE GRANDI (PER OMBRELLI "SENC")  
 PACK DE 100 SACOS GRANDES (P/ GUARDA-CHUVAS SENC)



Ref		
2100 1155	1	18,61

CESTA DE COMPRA CON RUEDAS / PANIER DE COURSES AVEC ROUES  
 SHOPPING BASKET WITH WHEELS / CESTA PER ACQUISTI CON RUOTE  
 CESTA DE COMPRA CON RUEDAS

CESTA DE COMPRA / PANIER DE COURSES / SHOPPING BASKET  
 CESTA PER ACQUISTI / CESTA DE COMPRA



Ref				
8900 9396	640 x 360 x 450 mm	52 L	1	62,50

Ref				
8900 9395	430 x 300 x 230 mm	22 L	1	25,00







	ES	FR	EN	IT	PT
<b>Ref</b>	Referencia	Référence	Reference	Riferimento	Referência
<b>M</b>	Métrica	Métrique	Metrical	Metrica	Métrica
	Packing	Conditionnement	Packing	Imballo	Embalagem
	Precio	Prix	Price	Prezzo	Preço
	Blíster	Blister	Blister	Blister	Blister
	Colores	Couleur	Color	Colore	Cores
	Medidas	Mesures	Measurements	Misure	Medidas
	Unidades	Unités	Units	Unitá	Unidades
	Longitud	Longueur	Length	Lunghezza	Comprimento
	Descripción	Description	Description	Descrizione	Descrição
	Diámetro	Diamètre	Diameter	Diametro	Diâmetro
	Unidad mínima de venta	Nombre d'unités minimum de vente	Minimum sale unit	Quantitativo minimo di vendita	Unidade mínima de venda





<b>A</b>			
Abarcón .....	588	Atornilladores neumáticos .....	251
Abocinadores .....	181	Autoarranque .....	630
Abono azul plantas y flores .....	789	Avisador acústico .....	632
Abrazadera tubo métrico cobre .....	703	Azadas .....	201
Abrazaderas .....	547	Azadón .....	203
Abrazaderas nylon .....	546	<b>B</b>	
Abrepuertas eléctrico .....	431	Banco plegable rectangular .....	801
Abrillantador neumáticos .....	628	Banco trabajo .....	78
Accesorio lubricante .....	254	Bandeja angular .....	881
Accesorios cable inox A-2 .....	579	Bandeja especial inclinada con soportes .....	881
Accesorios minicanal .....	699	Barbacoas .....	805
Accesorios taladro .....	485	Barbuquejo elástico .....	365
Aceite .....	315	Barniz .....	644
Aceite corte y taladro .....	624	Barniz transparente .....	639
Aceite de citronela .....	808	Barra de carga .....	882
Aceite especial cadenas de motosierra .....	43	Barras de pegamento termofusible .....	234
Aceite fino de vaselina .....	625	Barreño contenedor jardín .....	789
Aceite hidráulico .....	317	Base antenna .....	707
Aceite linaza .....	645	Base bipolar (toma cocina) .....	684
Aceite sintético motor .....	315	Base cuadrada superficie + toma de tierra .....	687
Aceite teka .....	645	Base enchufe aérea goma .....	683
Aceitera profesional .....	308	Base enchufe bipolar aérea .....	684
Acortador acceso directo a cadena .....	584	Base modular cuadrada (teléfono) .....	693
Adaptador antenna .....	707	Base múltiple tomas .....	704
Adaptador cartucho de grasa .....	301	Base para bridas .....	547
Adaptador enchufe + 2 usb .....	685	Bastón luminoso .....	770
Adaptador grifo .....	828	Batas .....	391
Adaptador multivia .....	684	Batería 4r25 6v .....	769
Adaptadores latón .....	829	Batería recargable .....	16
Adaptadores rosca jardín .....	827	Bermudas de trabajo .....	379
Adhesivo cianoacrilato .....	620	Big bag escombros .....	665
Adhesivo contacto .....	621	Bisagras .....	843
Adhesivo en spray .....	631	Bloqueo de parking .....	773
Adhesivo para pvc .....	621	Bobina cuerda papel .....	602
Adhesivo plásticos rígidos .....	622	Bobina hilo yute .....	602
Adhesivos residuos - tóxicos .....	733	Bobina industrial ecológica .....	658
Afijatado efecto frío .....	623	Bolsa portaherramientas .....	71-82
Aguarrás puro .....	643	Bomba de engrase neumática .....	304
Aguja de trazar de bolsillo .....	216	Bomba de grasa portátil .....	300
Aire comprimido .....	249-266-631	Bomba de trasvase a palanca .....	311
Alambre de espino .....	609	Bomba engrase doble alta presión profesional .....	301
Alambres y mallas metálicas .....	608	Bomba engrase manual para cartuchos .....	301
Alargador pintor extensible .....	658	Bomba engrase una mano .....	303
Alicates .....	108	Bomba engrase vertical para cartuchos .....	302
Alimentador de grasa policarbonato .....	307	Bomba plástica de palanca .....	313
Altavoz bluetooth a batería .....	12	Bomba rotativa para oil y fuel .....	311
Amoladora a batería .....	9	Bombas eléctricas .....	312
Amoladora eléctrica .....	22	Bombas engrase a palanca .....	302
Amoladora neumática .....	244	Bombilla led .....	711
Anclaje metálico .....	528	Boquilla engrase alta presión conexión rápida .....	305
Anclaje para andamios .....	527	Boquillas de engrase .....	305
Anclaje químico .....	533	Boquillas regulables .....	825
Anilla de anclaje .....	527	Botadores .....	130
Anilla de elevación .....	575	Botas de agua .....	402
Anilla para cadena .....	582	Braga polar .....	159
Anilla tte. Soldable .....	583	Briquetas de carbón .....	806
Anillas soldadas .....	571	Broca de centrar .....	498
Anillo conector cadena para conos .....	772	Broca guía .....	497
Anillos seeger .....	554	Broca para vidrio, cerámica y gres .....	479
Antiadhesivo para soldaduras .....	630	Broca porcelánico .....	481
Anticongelante .....	314	Brocas avellanadoras .....	485
Antideslizante .....	631	Brocas de construcción .....	474
Antipánico .....	435	Brocas escalonadas .....	484
Apaga llamas .....	633	Brocas para acero .....	466
Arco sierra .....	123	Brocas para madera .....	482
Arnés anticaídas .....	367	Brochas .....	650
Asiento de trabajo móvil .....	64	Burlete adhesivo .....	671
Aspersores .....	822	Buscapolos .....	107
Aspirador a batería .....	10	Buzones .....	445
Aspirador de cenizas a batería .....	12	Buzos de trabajo .....	378
Atornillador a batería .....	8-10	<b>C</b>	
Atornillador eléctrico multipuntas .....	11	Caballote con texto .....	750
		Caballote de gato .....	64
		Cabezas de acoplamiento .....	286
		Cable acero .....	589
		Cable antenna .....	708
		Cable eléctrico .....	702
		Cable para lámpara deco .....	716
		Cable plano teléfono .....	708
		Cadena .....	589
		Cadena de plástico .....	772
		Cadena elevación .....	583
		Cadena motosierra .....	43
		Caja cartón mudanza asa troquel .....	665
		Caja de empotrar mecanismos tubo .....	698
		Caja seguridad .....	441
		Cajas de herramientas .....	71
		Cajas superficie .....	701
		Calcetines .....	395
		Calibres .....	209
		Calzado de seguridad .....	396
		Calzado de trabajo .....	408
		Cámara de inspección portátil .....	65
		Camilla de trabajo .....	64
		Camiseta .....	391
		Cáncamo giratorio .....	584
		Candado combinación equipaje .....	441
		Candados .....	437
		Cantoneras espuma .....	664
		Cargador de batería .....	17
		Cargador pilas .....	681
		Carraca neumática 1/2" .....	247
		Carraca para trincaje .....	595
		Carretillas .....	63
		Carro de herramientas .....	66
		Carta colores ral .....	636
		Carta de colores esmaltes sintéticos .....	641
		Carteles para obras .....	758
		Casco soldadura automática .....	360
		Cascos anti-ruido .....	366
		Cascos de protección .....	365
		Cavahoyos de acero .....	206
		Cemento rápido .....	634
		Cepillo abrasivo .....	511
		Cepillos .....	217
		Cepillos para madera .....	185
		Cerradura eléctrica .....	430
		Cerraduras .....	424
		Cerraduras de buzón .....	844
		Cerraduras persianas .....	433
		Cerrojos .....	432
		Césped artificial .....	789
		Cesta 5 huecos para expositores .....	880
		Cesta de compra con ruedas .....	888
		Chaleco multibolsillo .....	389
		Chaqueta polar .....	389
		Chaqueta soft shell .....	390
		Chaquetas de trabajo .....	381
		Chinchetas .....	775-851
		Chips de relleno .....	665
		Cianocrilato .....	620
		Cierrapuertas .....	434
		Cierres .....	843
		Cierres para abrazaderas .....	548
		Cilindros .....	418
		Cinceles .....	206
		Cinta adhesiva con papel .....	660
		Cinta adhesiva pvc .....	668
		Cinta aislante de pvc .....	668
		Cinta americana .....	670
		Cinta antideslizante .....	762
		Cinta cáñamo .....	606
		Cinta de aluminio .....	669
		Cinta de carroceros "crepé" .....	670
		Cinta doble cara .....	669
		Cinta persiana .....	591



Cinta vulcanizable.....	671
Cintas de balizamiento.....	761
Cintas métricas.....	212
Círculo adhesivo.....	777
Cizalla.....	121
Cizalla corta-setos profesional.....	812
Clavadoras neumáticas.....	253
Clavija bipolar.....	683
Clavija bipolar goma.....	683
Clavija móvil industrial.....	686
Clavos.....	233
Cola blanca.....	621
Cola roedores.....	634
Colector de riego.....	828
Colgador.....	843
Colgador autoadhesivo.....	869
Colgador blíster adhesivo.....	760
Colgador jardinera.....	788
Colgador universal.....	882
Compases.....	215
Compresores.....	242
Conector antena.....	707
Conectores.....	826
Conexión flexible inox.....	288
Conjunto bandeja.....	881
Conjunto escarpa neumática.....	245
Conjunto tubo para hules y rollos.....	884
Cono a 4 caras.....	750
Conos.....	770
Contenedores.....	789
Contera negra.....	855
Coquillas antirruído.....	365
Cordón anticaídas.....	82
Cordón trenzado hippie.....	604
Cordón trenzado polipropileno.....	601
Corona taladro electromagnético.....	495
Coronas bimetalicas.....	498
Coronas de metal duro.....	496
Coronas diamantadas.....	503
Coronas diamante.....	503
Coronas para construcción.....	503
Coronas reafilables.....	497
Corta azulejos manual.....	190
Corta tubo de plástico.....	292
Cortacables.....	122
Cortacésped autopulsado.....	31
Cortacésped de mano a batería.....	14
Cortacésped eléctrico con ruedas.....	15
Cortafríos.....	206
Cortamangueras tijera.....	180
Cortasetos eléctrico a batería.....	14
Cortasetos eléctrico de largo alcance a batería.....	15
Cortatubos.....	177
Cortavarillas.....	122
Cristales de soldadura de recambio.....	359
Cubeta.....	658
Cubierta de mesa.....	803
Cubo jardinería con vertedor.....	789
Cubre zapatos.....	378
Cubremanchas.....	637
Cuchilla desbrozadora.....	35
Cuchillo recolección con depósito.....	813
Cuelgacaudros.....	851
Cuerda de plástico torcido.....	605
Cuerda de seguridad para arnés.....	370
Cuerda elásticas.....	600
Cuerda especial de arranque.....	601
Cuerda trenzada helicoidal.....	597
Cuerda trenzada polipropileno.....	598
Cuerdas.....	596
Cuerpo anclaje.....	527
Cuña metal leña.....	206
Cúter.....	127

## D

Decapante extra fuerte.....	646
Delantal y manguitos soldador.....	360
Desatascador líquido.....	632
Desbrozadora a gasolina.....	34
Desbrozadora eléctrica a batería.....	13
Desmontable neumáticos.....	134
Desoldador con boquilla antiestática.....	217
Desoxidante aflojatado.....	623
Destornillador con 6 puntas.....	105
Destornillador flexible para abrazaderas.....	550
Destornilladores.....	93
Detector de humos.....	690
Detector de inundación.....	690
Dinamométrica profesional.....	138
Discos abrasivos.....	452
Discos de corte.....	452
Discos de diamante.....	458
Discos laminados.....	456
Discos para piedra.....	461
Discos vulcanizados.....	455
Disolvente universal.....	646
Dispensador de bolsas para paraguas.....	888
Dispensador film manual.....	662
Display disco abrasivo.....	453
Display para césped artificial.....	792
Downlights.....	718

## E

Electrobomba sumergible.....	37
Electrodos.....	48
Elevador hidráulico.....	64
Embudo anti-salpicaduras.....	309
Embudo con filtro para combustible.....	308
Embudo cónico polietileno.....	309
Enchufe rápido gran caudal.....	259
Enchufes rápidos.....	257
Engrasadora eléctrica.....	300
Engrasadores.....	306
Engrase.....	868
Enrejado.....	608
Enrollables.....	706
Enrollador manguera.....	255-820
Equipamiento para jardín.....	820
Escaleras.....	58
Escoba plegable.....	817
Escobilla limpiaparabrisas.....	318
Escofinas.....	188
Escuadra magnética para soldar.....	217
Escuadras.....	213-845
Escudo antitaladro.....	431
Eslabón unión cadena plástico.....	772
Eslingas.....	592
Esmalte al agua.....	642
Esmalte antioxidante.....	643
Esmalte forja.....	642
Esmaltes sintéticos.....	640
Espátulas.....	195
Espejo de inspección telescópica articulado.....	216
Espejos.....	776
Espiga de madera.....	854
Espuma foam.....	666
Espuma poliuretano.....	618
Estanterías.....	61
Estuches de plástico.....	74
Expositor abrazaderas.....	549
Expositor alicates.....	110
Expositor coronas.....	499
Expositor de aflojatado.....	623
Expositor destornilladores.....	100
Expositor electrico mostrador.....	717
Expositor flexómetros.....	211
Expositor góndola.....	876

Expositor metal para dinamométricas.....	138
Expositor perforado.....	875
Expositor pilas.....	681
Expositor rincón mural.....	877
Expositor vertical perforado.....	878
Expositores.....	100-110-113-138-211-499-870
Expositores de pintura.....	639
Extractores.....	134
Extractores de tornillos.....	134-493

## F

Faja con tirantes.....	376
Faro de trabajo.....	321
Fieltro.....	855
Fijación en blíster.....	864
Fijador y sellador.....	622
Film embalaje.....	661
Filtros de aire.....	256
Flexómetros.....	210
Foco led portátil a batería.....	11-717
Formones.....	185
Fratás.....	192
Fresadora neumática.....	244
Fresas rotativas.....	506

## G

Gafas abatibles de protección.....	358
Gafas de seguridad.....	352
Galgas de espesores.....	213
Galvanizado en frío.....	638
Gancho "s" cadena plástico.....	772
Gancho basculante.....	531
Gancho blíster doble.....	884
Gancho con seguro alta resistencia.....	585
Gancho pequeño.....	851
Gancho redes.....	588
Gancho simple.....	883
Gancho simple con etiquetero.....	883
Gancho soldable.....	584
Ganchos cortina.....	854
Garabatos.....	205
Garra metalica galvanizada cepillo barrendero.....	222
Gato hidráulico.....	65
Gavetas.....	75-80
Generador.....	29-43
Giramachos.....	494
Glasspack adhesivo.....	756
Gomas de ancla.....	817
Gomas especiales para empalmes.....	830
Gorra de seguridad.....	365
Gota protectora.....	855
Gotero.....	835
Granetes.....	130
Grapa con pie.....	553
Grapa plástico cable.....	703
Grapadora neumática.....	252
Grapadora/clavadora neumática.....	252
Grapadoras.....	231
Grapas.....	233
Grasa.....	625
Grasa litio.....	625
Grifo polietileno container.....	310
Grillete.....	576
Guantes aislantes.....	339
Guantes anticorte.....	340
Guantes antivibración.....	342
Guantes de látex.....	348
Guantes de látex rugoso.....	347
Guantes de neopreno y nitrilo.....	349
Guantes de nylon y algodón.....	339
Guantes de piel.....	336
Guantes de pvc.....	349
Guantes desechables.....	350
Guantes impregnados.....	344





Guardacabos .....	571	Llave filtros autorregulable .....	182	Mostrador modular .....	885
<b>H</b>		Llave para ruedas .....	184	Motoazada .....	32
Hachas .....	200	Llave para tubo .....	175	Motobomba gasolina .....	36
Hammerlock para cadena .....	585	Llave stillson .....	175	Motosierra .....	41
Haragan metalico industrial .....	222	Llave sueca .....	176	Mueles abrasivas .....	457
Hidrorepelente .....	630	Llaves .....	139	Muelle neumático .....	319
Higienizante .....	629	Llaves ajustables .....	173	Multiherramienta a batería .....	9
Hilo bramante cáñamo .....	605	Llaves allen y torx .....	169	<b>N</b>	
Hilo de sedal .....	606	Llaves de bujías articuladas .....	184	Navaja plegable de injertar .....	129-813
Hilo redondo para desbrozadora .....	34	Llaves de gancho .....	183	Nevera térmica rígida con asa .....	800
Hilos de rafia sintética .....	604	Llaves de impacto .....	159	Niveles .....	208
Hojas de sierra .....	125-251	Llaves en bruto para candados .....	439	<b>O</b>	
Horcas .....	205	Llaves ribe acodadas .....	172	Ovillo de algodón .....	606
Husillos portacoronas con broca .....	498	Lubricante .....	623	<b>P</b>	
<b>I</b>		Luz estacionaria .....	767	Palanca encofrador .....	190
Imán para pizarra .....	775	Luz giratoria .....	766	Palas .....	199
Impermeabilizante .....	649	Luz led .....	721	Paletas de construcción .....	196
Imprimación antióxido .....	638	<b>M</b>		Paletina canaria .....	652
Imprimación sintética .....	643	Macetas .....	135-787	Palomillas .....	849
Indicador de nivel para grifo .....	310	Machos de roscar .....	489	Panel portaherramientas .....	78
Inflador neumático profesional .....	250	Machos y terrajas en kit .....	493	Pantalla de rejilla .....	365
Inox spray .....	638	Madeja cuerda plástico .....	602	Pantallas de protección .....	358
Interruptor aéreo .....	687	Madeja de estopa .....	606	Pantalones de trabajo .....	380
Inyector de valvulina .....	304	Magnetizador - desmagnetizador .....	105	Parrillas .....	804
<b>J</b>		Maletín abrazaderas .....	552	Pasacables en spray .....	631
Jabón de manos .....	316	Maletines de coronas .....	499	Pasador cerrojo .....	842
Jardinería y plato .....	788	Maletines de herramientas .....	83	Pasadores .....	557
Juego 2 cojinetes para carretilla .....	231	Maletines surtidos de brocas .....	473	Pastillas de encendido .....	807
Juego fresas rotativas .....	510	Malla antihierbas .....	794	Pedal contenedor .....	790
Juegos de brocas .....	465	Malla antipájaros .....	794	Pegamento "ms" .....	617
Juntas tóricas .....	560	Malla de señalización .....	662	Peine de roscas .....	213
<b>K</b>		Malla electrosoldada .....	608	Película removible .....	636
Kit aporcador .....	32	Malla rápida .....	587	Pequeño material .....	842
Kit cortasetos, mano extensión y ruedas a batería .....	14	Malla sombreo .....	792	Percha .....	882
Kit de igualamiento y amaestramiento .....	433	Mallas plásticas .....	796	Perno redondo .....	843
Kit de nebulización .....	819	Mango guadaña .....	204	Pico de cavar .....	136
Kit esmaltar .....	658	Mango portacoronas .....	504	Pies de rey .....	209
Kit herramienta neumática .....	254	Mangos madera .....	205-220-817	Pila botón .....	682
Kit mangueras .....	819	Mangueras .....	255-818	Pilas alcalinas .....	680
Kit multiplicador de par .....	168	Maniquís .....	887	Pilas recargables .....	681
Kit pinza masa con cable .....	47	Manivelas .....	442	Pincel .....	652
Kit portaelectrodos con cable .....	47	Manómetro e inflador .....	250	Pincho inoxidable .....	804
Kits de ojetes .....	132	Manta protectora .....	667	Pintura acrílica efecto cromo .....	637
<b>L</b>		Manta protectora suelos + plástico .....	660	Pintura anticorrosiva .....	639
Lámpara baliza señalización .....	769	Marcador spray fluorescente .....	638	Pintura efecto forja .....	637
Lámpara h1 (luz giratoria) .....	769	Marco abs .....	756	Pintura en spray .....	635
Lámpara led .....	710	Marco aluminio para señal .....	760	Pintura piscinas .....	649
Lámparas automoción .....	322	Martillos .....	135	Pintura plástica .....	647
Latiguillos de engrase flexibles .....	305	Máscara de soldadura .....	359	Pintura reflexiva .....	638
Lavamanos .....	316	Mascarillas .....	362	Pinza barbacoa .....	804
Lavaparabrisas .....	314	Masilla plástica al agua .....	648	Pinza de masa .....	47
Leñero .....	806	Masilla poliuretano .....	618	Pinzas arranque .....	320
Lijas .....	463	Masilla selladora .....	617	Pinzas portaelectrodos .....	47
Limas .....	186	Maza .....	136	Pistola aire caliente .....	21
Limpiador .....	627	Mecanismos eléctricos .....	691	Pistola cola termofusible .....	234
Limpiador de contactos eléctricos .....	627	Medidor distancias láser .....	214	Pistola de impacto a batería .....	12
Limpiador de espuma de poliuretano .....	619	Mesa alta plegable .....	803	Pistola de petroleo .....	254
Limpiador de frenos y embragues .....	627	Mesa oval .....	798	Pistola para spray .....	637
Limpiador para metales .....	627	Mesa plegable cuadrada .....	802	Pistola silicona .....	619
Limpiador salpicaderos con silicona .....	628	Mesa plegable rectangular .....	801	Pistolas de impacto .....	247
Limpiadora alta presión .....	40	Mesa ratán antracita .....	799	Pistolas de pintar .....	250
Línea de vida .....	375	Mesa redonda plegable .....	802	Pistolas de riego .....	824
Linternas .....	719	Mezclador anclaje químico .....	533	Pistolas de soplar .....	249
Líquido de encendido .....	808	Micrómetro para exteriores .....	213	Pizarra fondo de corcho .....	775
Llanas .....	191	Mini bomba de grasa con pulsador .....	304	Placa de unión .....	845
Llave ajustable para filtros aceite .....	182	Mini sierra circular eléctrica .....	19	Plástico cubretodo .....	659
Llave de cadena reversible .....	183	Minio de plomo .....	643	Plomada trazadora .....	190
Llave de correa .....	182	Mirilla de latón .....	842	Podadora de largo alcance .....	816
Llave de lavabo .....	181	Modulo de herramientas .....	67	Polea .....	574
		Monos de trabajo .....	386	Polea con tirafondo .....	844
		Mopa limpiadora .....	222	Polímero sellador .....	617
		Mordazas para taladro de banco .....	133		
		Mosquetones .....	374-572		



Polos .....	390	Rollo malla tubular espuma .....	666	Taladro atornillador a batería .....	8
Polvo azul para plomada .....	190	Rollo papel "kraft" .....	660	Taladro impacto .....	24
Pomos .....	845	Rollo plástico burbuja .....	667	Taladro martillo perforador SDP .....	26
Portalámparas .....	687	Rollo tubo espiral aspiración .....	821	Taladro neumático .....	244
Portaprecios con tira para bandeja .....	881	Rollos plástico con cinta .....	659	Taladro percutor a batería .....	8
Poste abatible para parking .....	773	Ropa de alta visibilidad .....	379	Tamiz anclaje químico .....	533
Poste cinta extensible .....	771	Rueda giratoria andamio c/freno .....	231	Tapón para taco de andamios .....	527
Poste y base para cadena .....	772	Ruedas .....	223	Tapones para oídos .....	366
Precinto acrílico .....	669	Ruedas carretilla .....	229	Tapones para remaches .....	543
Precinto transparente acrílico .....	670	<b>S</b>		Temporizador de riego .....	824
Programador horario .....	689	Sacabocados .....	131	Tenaza para filtros de aceite .....	182
Prolongacion antena .....	707	Saco de yute .....	663	Tenazas .....	117
Prolongador de columna .....	878	Sacos de polymesh .....	663	Tenazas curvatubos .....	181
Prolongador eléctrico .....	705	Sacos de rafia .....	663	Tensor .....	577
Prolongador rígido curvo .....	305	Sargentos .....	185	Tensor de carraca .....	595
Protección de caucho .....	773	Selladora sintética .....	644	Tensores carraca reforzados .....	817
Protector bornes de batería .....	626	Señal de mano con mango aluminio .....	762	Termostato calefacción .....	689
Protector para cables .....	774	Señalética imantada .....	879	Terrajas ajustables .....	493
Proyector led smd .....	717	Señalización .....	732	Terrajas de roscar .....	490
Ptfe líquido .....	622	Señalización .....	732	Téster electrónico medidor de tensión .....	108
Puerta de acceso mecánico .....	887	Señalización materias peligrosas .....	733	Tijeras .....	120
Pulpo cadena .....	582	Señalización para automoción .....	763	Tijeras cortacésped .....	812
Pulpos elásticos .....	607	Separador de llaves .....	855	Tijeras de carraca .....	811
Pulverizador de espalda .....	784	Serrucho carpintero .....	125	Tijeras de poda .....	814
Pulverizador manual .....	785	Set para sanitario wc .....	524	Tijeras de recolección .....	809
Puntas de acero .....	850	Sierra circular .....	18	Tinte al agua .....	647
Puntas de atornillar .....	87	Sierra de cadena eléctrica a batería .....	15	Tira led .....	718
Puntero .....	207	Sierra de calar .....	20-499	Tirafondos .....	857
Punzón taladro electromagnético .....	494	Sierra de poda .....	813	Tirafondos con rosca .....	553
Punzones de números - letras .....	131	Sierra neumática .....	251	Tiras antideslizantes .....	672
<b>Q</b>		Sierras de cinta .....	502	Tiras de plástico para blister .....	872
Quita grafiti .....	630	Silicona .....	616	Toallitas para limpieza .....	633
Quitamanchas .....	631	Silla alta plegable .....	803	Toldo .....	797
Quitapinturas "gel" .....	646	Silla plegable blanca .....	801	Tope de persiana .....	846
<b>R</b>		Silla/cama playa fibrelina azul con asa aluminio .....	800	Topes .....	846
Racorería de plástico .....	261	Sillas .....	798	Tornillería en blister .....	856
Racorería metálica .....	266	Sillón plegable fijo lacado fibrelina azul .....	800	Tornillo de banco .....	133
Racorería TEA .....	289	Sillón ratán antracita .....	799	Trajeras de agua .....	392
Raedera .....	203	Sincronizador de riego .....	823	Trencilla polipropileno .....	596
Rascador de monocapa .....	192	Sisal pita 2 cabos .....	603	Trenza de poliamida .....	596
Rastrillo .....	817	Sobres kraft con burbuja .....	664	Trenzado de poliéster .....	605
Rastrillo forjado .....	204	Soldador cilíndrico .....	216	Triángulo de avería .....	769
Rebabador .....	176	Soplador de mochila .....	33	Trincaje .....	593
Recambio luz giratoria .....	768	Soplador inverter eléctrico .....	45	Tubería hidro gris certificada .....	821
Recogedor aceite usado .....	308	Sopladora eléctrica a batería .....	13	Tuberías de poliamida .....	291
Recogedor de largo alcance .....	815	Soporte calzado .....	883	Tuberías de poliuretano .....	292
Recogedores cinta .....	846	Soporte de plástico y porta-visera .....	365	Tubo led .....	710
Recogedores telescópicos con clip de bolsillo .....	216	Soporte luz giratoria .....	769	Tubos de riego por goteo .....	830
Reducciones de plástico .....	457	Soporte para soldar estaño .....	216	Tuercas remachables .....	544
Reductor velocidad .....	774	Soporte pared para manguera .....	820	<b>V</b>	
Reflexivos bandas oblicuas .....	765	Soportes .....	853	Valla extensible .....	771
Reglas .....	214	Sosa cáustica .....	645	Válvula de bola .....	286
Regleta conexión .....	703	Sudadera .....	388	Vitrina corcho cierre .....	775
Regleta led .....	710	Sujetacables .....	570	Vitrina magnética .....	775
Reguladores presión .....	826	Surtido tubos termorretráctiles .....	702	Volvedores .....	494
Remachadora .....	534	<b>T</b>		<b>Y</b>	
Remachadora neumática .....	245	Taburete aluminio .....	59	Yeso estucar .....	634
Remaches .....	536	Taburete plegable .....	802	<b>Z</b>	
Reparador de pinchazos .....	629	Tachuela .....	851	Zacho .....	204
Reparadores .....	826	Taco alado .....	520	Zócalo superficie para mecanismos variados .....	699
Retenedor de rodamientos .....	626	Taco autoperforante .....	523		
Revestimiento petreo fachadas .....	647	Taco expansión por golpe .....	531		
Riego por goteo .....	830	Taco extra largo .....	527		
Riel trenzado de polipropileno .....	596	Taco flecha .....	522		
Rodilleras .....	376	Taco largo con tornillo .....	526		
Rodillos .....	653	Taco para bridas .....	547		
Rollo alambre galvanizado .....	608	Taco pequeñas cargas .....	521		
Rollo cartón .....	664	Taco pladur .....	523		
Rollo cinta ptfe .....	668	Taco plástico .....	520		
Rollo film .....	666	Taco rápido golpe .....	525		
Rollo malla f.De vidrio .....	662	Tacos anudables .....	521		
Rollo malla tubular .....	667	Tacos de fijación .....	521		
		Taladrina .....	624		



<b>A</b>		
Accessoires minicanal .....	699	
Accessoires pour le câble inox. A-2 .....	579	
Accessoires pour le jardin .....	820	
Accessoires pour perceuse .....	485	
Accroche cadre .....	851	
Adaptateur avec de filetage pour jardin .....	827	
Adaptateur de chargeur mural à double port usb .....	685	
Adaptateur de robinet .....	828	
Adaptateur multiprise .....	684	
Adaptateur pour cartouche .....	301	
Adhésif en aérosol .....	631	
Adhésif isolant .....	668	
Adhésifs résidus-toxiques .....	733	
Affichages pour travaux .....	758	
Agrafe plastique câble .....	703	
Agrafes .....	233	
Agrafeuse .....	231	
Agrafeuse/cloueuse pneumatique .....	252	
Aide au démarrage .....	630	
Aimant para tableau .....	775	
Air comprimé .....	249-266-631	
Alimentation graisse de polycarbonate .....	307	
Américain .....	670	
Ampoule .....	322	
Ampoule (lampe rotative) .....	769	
Ampule led .....	711	
Ancrage chimique .....	533	
Ancrages femelles à cône intérieur .....	531	
Aneaux seeger .....	554	
Anneau ancrage .....	527	
Anneau de levage .....	575	
Anneau pour chain .....	582	
Anneau soudé .....	571	
Anti-adhérent pour soudage .....	630	
Antidérapant .....	631	
Antigel .....	314	
Antioxydant .....	638	
Antipanique .....	435	
Appareil à battre les collets .....	181	
Appareil de contrôle en couleur .....	65	
Arrosage goutte à goutte .....	830	
Aspirateur à batterie .....	10	
Aspirateur à cendre batterie .....	12	
Assortiment tubes thermoretractables .....	702	
Attaches élastiques .....	817	
Avertisseur à gaz .....	632	
<b>B</b>		
Bâche .....	797	
Balai d'essuie glace .....	318	
Balais .....	217	
Balais microfibrés .....	222	
Banc rectangulaire pliable .....	801	
Bande led .....	718	
Bandes antidérapantes .....	672	
Bandes plastique pour blister .....	872	
Bandes réfléchissantes obliques .....	765	
Barbecues .....	805	
Barras de cola termofusible .....	234	
Barre de charge .....	882	
Base à multiprises prises .....	704	
Base antenne .....	707	
Base bipolaire (prise cuisine) .....	684	
Base carrée superficie + prise terre .....	687	
Base pour brides .....	547	
Base prise bipolaire air .....	684	
Base prise caoutchou air .....	683	
Batterie rechargeable .....	16	
Bermudas de travail .....	379	
Bleux de travail .....	378	
Blochage pour place parking .....	773	
Bloc à aimanter .....	105	
Bloquant .....	622	
Blouses .....	391	
Bobine corde danoise .....	602	
Bobine industrielle écologique .....	658	
Boîte à outils .....	71	
Boîte carton déménagement avec anses découpées .....	665	
Boîtes aux lettres .....	445	
Boitier a encastrer mécanismes universel .....	698	
Boitier de surface .....	701	
Bottes de pluie .....	402	
Bouche graisseurs .....	305	
Bouchon pour cheville d'échaffaudage .....	527	
Bouchons d'oreilles .....	366	
Bouclier anti perforation .....	431	
Boulon en u .....	588	
Bras universel .....	882	
Brillant pour zinc .....	638	
Briquettes .....	806	
Brise vue maille occultation verte .....	792	
Brosse abrasif .....	511	
Bulles de protection .....	855	
Burette à huile professionnel .....	308	
Burins .....	206	
<b>C</b>		
Câble d'antenne .....	708	
Câble électrique .....	702	
Câble en acier inox .....	589	
Câble plat téléphone .....	708	
Cable pour globe deco .....	716	
Câbles de démarrage .....	320	
Cadenas .....	437	
Cadenas à combinaison pour bagage .....	441	
Cadre de protection .....	756	
Caisse de forets .....	473	
Calfeutrage adhésif .....	671	
Canne lumineuse .....	770	
Carré magnétique pour souder .....	217	
Carte de couleurs ral .....	636	
Carte de couleurs émail synthétique .....	641	
Casier .....	75-80	
Casque d'ingénieur .....	365	
Casques antibruit .....	366	
Casquette de sécurité .....	365	
Ceinture avec bretelles .....	376	
Cercle adhésif .....	777	
Chaîne .....	589	
Chaîne de levage .....	583	
Chaîne de tronçonneuse .....	43	
Chaîne en plastique .....	772	
Chaise .....	798	
Chaise plage-lit positions .....	800	
Chaise pliante blanche .....	801	
Chaise pliante haute .....	803	
Chargeur de batterie .....	17	
Chargeur de piles .....	681	
Chariot de visite .....	64	
Chariots a outils .....	66	
Charnières .....	843	
Chaussettes .....	395	
Chaussures de securite .....	396	
Chaussures de travail .....	408	
Chevalet pour atelier .....	64	
Chevalet de signalisation danger .....	750	
Cheville a ailette .....	520	
Cheville bipolaire .....	683	
Cheville bipolaire caoutchou .....	683	
Cheville extra-longue .....	527	
Cheville flèche .....	522	
Cheville industrielle .....	686	
Cheville longue avec vis .....	526	
Cheville plastique .....	520	
Cheville pour pladur .....	523	
Chevilles autoperceuse .....	523	
Chevilles de fixation .....	521	
Chevilles de fixation pour grande expansion .....	521	
Chevilles en acier .....	528	
Chevilles pour brides .....	547	
Chevilles rapides .....	524	
Chips de remplissage .....	665	
Ciment rapide .....	634	
Cisailles .....	120	
Cisailles professionnelles .....	812	
Ciseau coupe tube .....	180	
Ciseaux .....	206-809	
Ciseaux a bois .....	185	
Ciseaux à gazon .....	812	
Clé à chaîne réversible .....	183	
Clé à choc .....	247	
Clé à choc batterie .....	12	
Clé a sangle .....	182	
Clé allen et torx .....	169	
Clé crochet .....	183	
Clé filtres autoréglable .....	182	
Cle lavabo .....	181	
Clé réglable .....	173	
Clé réglable pour filtres a huile .....	182	
Clé ribe courbee .....	172	
Cle serre-tube .....	175	
Clés .....	139	
Clés a bougie art .....	184	
Clés brutes pour cadenas .....	439	
Clés pour roues .....	184	
Clés stillson .....	175	
Cliquet a sangle .....	595	
Cliquet pneumatique .....	247	
Clôture extensible .....	771	
Cloueuse pneumatique .....	252	
Clous .....	233	
Coffret ciseleur pneumatique .....	245	
Coffret sécurité .....	441	
Colle blanche .....	621	
Colle contact .....	621	
Colle cyanoacrylate .....	620	
Colle piège rongeurs .....	634	
Colle pour plastiques rigides .....	622	
Colle pour pvc .....	621	
Collecteur d'arrosage .....	828	
Colliers .....	547	
Combinaison de travail .....	386	
Compases .....	215	
Compresseurs .....	242	
Cône 4 faces .....	750	
Cones .....	770	
Connecteur antenne .....	707	
Connecteur bague chaîne pour cones .....	772	
Connecteur d'antenne .....	707	
Connecteurs .....	826	
Container jardin .....	789	
Containers .....	790	
Coquilles anti-bruit .....	365	
Corde antichutes .....	82	
Corde de polyester .....	605	
Corde de polypropylène .....	596	
Corde de sécurité pour harnais .....	370	
Corde en plastique en écheveaux .....	602	
Corde plastique courbée .....	605	
Corde spéciale de démarrage .....	601	
Corde tressée .....	604	
Corde tressée en polypropylène .....	598-601	
Corde tressée hélicoïdale .....	597	
Cordeur traceur .....	190	
Corderie .....	596	
Cordes élastiques .....	600	
Cordon tressé de polypropylène .....	596	
Corps ancrage .....	527	
Coupe boulons .....	122	
Coupe carreaux manuel .....	190	



Coupe tubes .....	177-292	Elingues .....	592	Gants en nylon et coton .....	339
Coupe-boulons .....	122	Email à l'eau .....	642	Gants en peau .....	336
Couronne perceuse electro-magnetique .....	495	Email forge .....	642	Gants en pvc .....	349
Couronnes aiguissables .....	497	Email synthétique .....	640	Gants imprégnés .....	344
Couronnes bimétalliques .....	498	Embout .....	846	Gants isolants .....	339
Couronnes métalliques .....	496	Embout de bois .....	854	Gants jetables .....	350
Couronne tuyau spiralé d'aspiration jaune .....	821	Embout noir .....	855	Gants rug latex .....	347
Couteau .....	127	Embout persienne .....	846	Gazon artificiel .....	790
Couteau de récolte avec réservoir .....	813	Embouts por visseuses .....	87	Gel decapant peintures .....	646
Couteau greffe pliable .....	129-813	Engrais bleu .....	789	Genouillères .....	376
Couverture de protection .....	667	Enrouleur .....	846	Gilet multipoche .....	389
Couverture protecteur sols + plastique .....	660	Enrouleur cable .....	706	Glacière thermique avec anse .....	800
Creuse-trous acier .....	206	Enrouleur tuyau .....	255-820	Glasspack adhésif .....	756
Cric hydraulique .....	64	Ensemble plateau .....	881	Gonfleur pneumatique professionnel .....	250
Crochet .....	584-843	Entonnoir anti-éclaboussures .....	309	Gonfleur-manomètre de pneumatiques .....	250
Crochet "s" chaîne en plastique .....	772	Entonnoir avec filtre a carburant .....	308	Goupilles .....	557
Crochet à œil linguet sécurité .....	585	Entonnoir conique polyéthylène .....	309	Goutteur .....	835
Crochet auto adhésif .....	869	Enveloppes kraft a bulles .....	664	Graisse .....	625
Crochet avec porte-étiquette .....	883	Equerre .....	213-845-849	Graisse au lithium .....	625
Crochet avec securite .....	583	Essence de térébenthine pure .....	643	Graisseurs .....	306
Crochet basculant .....	531	Etagères .....	61	Graisseurs flexibles .....	305
Crochet double .....	884	Etau a mors .....	133	Graisseuse électrique .....	300
Crochet en s .....	588	Extension de colonne .....	878	Grand sac pour encombrants .....	665
Crochet petit .....	851	Extension rigide courbee .....	305	Griffe métallique galvanisée balai de cantonier .....	222
Crochet rotatif .....	584	Extincteur .....	633	Grignoteuse .....	121
Crochet simple .....	883	Extracteur .....	134	Grillage .....	608
Crochets pour échaffaudage .....	527	Extracteur matériaux légers .....	131	Grillage electrosoude .....	608
Crochets rideau .....	854	<b>F</b>		Grille .....	804
Cuvette .....	658	Fauteuil pliant bleu .....	800	Groupe électrogène .....	29-43
Cyanoacrylate .....	620	Fauteuil rattan bistrot .....	799	Gyrophare .....	766
Cylindres .....	418	Ferme-portes .....	434	<b>H</b>	
<b>D</b>		Fermetures .....	843	Haches .....	200
Deboucheur liquide .....	632	Feuille .....	661	Hammerlock pour chaîne .....	585
Débroussailleuse à essence .....	34	Feuilles de scie .....	125-251	Harnais anti chute .....	367
Débroussailleuse électrique sur batterie .....	13	Feutre .....	855	Haut-parleur bluetooth .....	12
Decapant extra fort .....	646	Fil barbele .....	609	Houe .....	203
Décapeuse monocouche .....	192	Fil bordé chanvre .....	605	Houes .....	201
Déconnexion rapide du raccord .....	305	Fil d'emballage en chanvre .....	606	Housse de table haute .....	803
Degrippant multifonction .....	623	Fil de fer et treillis métalliques .....	608	Huile .....	315
Demonte pneus .....	134	Fil de jute en bobine .....	602	Huile coupe et foret .....	624
Détachants .....	631	Fil monofilament de .....	606	Huile de citronnelle .....	808
Detecteur d'inondation .....	690	Fil plombier .....	606	Huile de lin .....	645
Detecteur de fumee .....	690	Fil rond pour débroussailleuse .....	34	Huile de teck .....	645
Détergent mousse polyuréthane .....	619	Filet de signalisation .....	662	Huile de vaseline .....	625
Devidoir ruban extensible .....	771	Filet plastique .....	795	Huile hydraulique .....	317
Diablos .....	63	Filets anti-oiseaux .....	794	Huile spéciale pour la chaîne de tronçonneuse .....	43
Display pour gazon artificiel .....	792	Filieres .....	490	Huile synthèse pour moteur .....	315
Dispositif de serrage pour colliers .....	548	Filières réglables .....	493	Hygienique .....	629
Dispositif de tracer .....	130	Film amovible .....	636	<b>I</b>	
Disques à lamelles .....	456	Fils de raphia synthétique .....	604	Ice sblock contre la rouille .....	623
Disques abrasifs .....	452	Filtres a air .....	256	Imprime synthétique .....	643
Disques de coupe .....	452	Fissatore elastico .....	365	Indicateur de niveau pour robinet .....	310
Disques de diamant .....	458	Fixation polymère .....	617	Interrupteur air .....	687
Disques meule .....	457	Fixations .....	864	<b>J</b>	
Disques pour le bois .....	461	Flexible de raccordement inox .....	288	Jardinière cube avec drain .....	789
Disques vulcanisés .....	455	Flexibles a air - tuyau .....	255-818	Jardiniere et plateau .....	788
Dissolvant universel .....	646	Foret guide .....	497	Jauge de filetage .....	213
Distributeur de sacs pour parapluie .....	888	Foret guide pour couronnes bimétalliques .....	498	Jeu 2 coussinets pour brouette .....	231
Doigt magnetique telescopique poche á clips .....	216	Foret porcelaine .....	481	Jeux de forets .....	465
Douilles a choc .....	159	Foret pour verre, céramique et grès .....	479	Joints toriques .....	560
Downlights .....	718	Forets bois .....	482	Judas en laiton .....	842
Droite .....	576	Forets de construction .....	474	<b>K</b>	
Dynamometrique professionnel .....	138	Forets de diamant .....	503	Kit d'appareillage et d'apprentissage .....	433
<b>E</b>		Forets en acier .....	466	Kit d'entretien pour outillage pneumatique .....	254
Ebavureur pour tubes .....	176	Forets fraiseurs .....	484	Kit de buttoir .....	32
Echelle .....	58	Fourche a griffes .....	205	Kit de oeillets complets .....	132
Ecran de protection .....	358	Fourches .....	205	Kit demultiplicateur de force pour boulons a roues .....	168
Ecrous à river .....	544	<b>G</b>		Kit fraises rotatives .....	510
Élastiques plats .....	607	Gant anti-coupure .....	340	Kit peintre .....	658
Électrodes .....	48	Gants anti-vibration .....	342	Kit pince de masse avec câble .....	47
Electropompe submersible .....	37	Gants en latex .....	348		
Elimine les grafitis .....	630	Gants en néoprène et nitrile .....	349		



Kit pince porte électrodes avec câble .....	47
Kit pulverisateur .....	819
Kit taille haie a main extension et roues a batterie. 14	
Kit tuyau .....	819
Kits d'outils à main .....	83

## L

Lame pour debrossailleuse .....	35
Lampe de travail .....	321
Lampe led .....	710-721
Lampe rotative .....	767
Lampe torche .....	719
Laque acrylique spray .....	635
Lave-glaces .....	314
Lien union chaîne en plastique .....	772
Ligne de vie .....	375
Limes .....	186
Lingettes mains .....	633
Liquide allumage .....	808
Liquide de coupe .....	624
Lubrifiant .....	623
Lubrification .....	868
Lunettes à souder .....	358
Lunettes de sécurité .....	352

## M

Maille rapide .....	587
Malette colliers .....	552
Malette des scies .....	499
Mallette en plastique .....	74
Manche en bois .....	205-220-817
Manche faux cofan .....	204
Manche pour perceuse .....	504
Mandrin avec foret interchangeable .....	498
Mannequin .....	887
Marteaux .....	135
Mase .....	136
Masque .....	362
Masque à souder .....	359
Masque a souder automatique .....	360
Massette - pots de fleurs .....	135-787
Mastic de fixation .....	617
Mastic plastique à l'eau .....	648
Mastic polyuréthane .....	618
Mécanismes électriques .....	691
Melangeur resine chimique .....	533
Mesureur distances laser .....	214
Mètre .....	210
Meule épaisseur .....	213
Meuleuse à batterie .....	9
Meuleuse électrique .....	22
Meuleuse pneumatique .....	244
Micromètre extérieur .....	213
Mini pompe à graisse .....	304
Mini scie circulaire électrique .....	19
Minimum de plomb .....	643
Miroir d'inspection telescopique .....	216
Miroirs .....	776
Modules outillage .....	67
Motobineuse .....	32
Motopompe à essence .....	36
Mousqueton .....	374-572
Mousse foam .....	666
Mousse polyuréthane .....	618

## N

Nettoyant .....	627
Nettoyant de contacts électriques .....	627
Nettoyant et lustrant pour les pneus .....	628
Nettoyant haute pression .....	40
Nettoyant métal .....	627
Nettoyant pour freins et embrayage .....	627
Nettoyant tableau de bord avec silicone .....	628
Niveau .....	208

## O

Outil lubrificateur .....	254
Outil multifonction à batterie .....	9
Ouverture réglable .....	825
Ouvre-porte électrique .....	431

## P

Panier 5 diviseurs pour presentoir .....	880
Paniers à courses .....	888
Panneau porte outils .....	78
Panneaux a main manche aluminium .....	762
Pantalon de travail .....	380
Papier abrasif .....	463
Passe cables en spray .....	631
Passe-câbles .....	571
Pastille d'allumage .....	807
Pastilles cache - rivets .....	543
Pédale pour poubelle .....	790
Peinture à léau .....	647
Peinture antioxydante .....	643
Peinture effet forge .....	637
Peinture haute temperature .....	639
Peinture piscines .....	649
Peinture plastique .....	647
Peinture réfléchissante .....	638
Pelles .....	199
Pelote de coton .....	606
Pentures rondes .....	843
Perceuse à batterie .....	8-10
Perceuse à impact .....	24
Perceuse à percussion sds-plus .....	26
Perceuse électrique multipointes .....	11
Perceuse pneumatique .....	244
Perche .....	882
Petit matériel .....	842
Petites chevilles pour matériaux creux .....	521
Pics brochettes inoxydables .....	804
Pieces de rechange lampe giratoire .....	768
Pied de biche .....	190
Pieds à coulisse .....	209
Pile 4r25 6v .....	769
Pile bouton .....	682
Piles alcalines .....	680
Piles rechargeables .....	681
Pince a cintrer .....	181
Pince a sertir .....	108
Pince de masse .....	47
Pince porte électrode .....	47
Pinceau .....	652
Pinceau plat .....	652
Pinceaux .....	650
Pincés barbecue .....	804
Pioche .....	136
Pistolet a air .....	249
Pistolet à air chaud .....	21
Pistolet a clou pneumatique .....	253
Pistolet à colle .....	217
Pistolet colle thermofusible .....	234
Pistolet d'aspiration .....	304
Pistolet d'irrigation .....	824
Pistolet pour nettoyage de moteur .....	254
Pistolet pour silicone .....	619
Pistolet pour spray .....	637
Plaques union .....	845
Plastique de couverture .....	659
Plat .....	191
Plateau angulaire .....	881
Plateau spécial incliné avec supports .....	881
Plâtre a enduire .....	634
Poignée .....	845
Poignées .....	442
Poinçon .....	207
Poinçon pour perceuse électromagnétique .....	494

Pointe à tracer de poche .....	216
Pointe acier .....	850
Pointe métal bois .....	206
Poliuretano flexibles .....	292
Polos .....	390
Polyamide twist .....	596
Pompe a graisse .....	302
Pompe a graisse double haute pression professionnelle .....	301
Pompe a graisse manuelle a cartouche .....	301
Pompe à graisse pneumatique .....	304
Pompe a graisse portable .....	300
Pompe à graisse une main .....	303
Pompe a graisse verticale a cartouche .....	302
Pompe plastique a levier .....	313
Pompe rotative pour huile et carburant .....	311
Pompes électriques .....	312
Porte d'accès mécanique .....	887
Porte outils .....	71-82
Porte-buches .....	806
Porte-lampe .....	687
Poste à soudage inverter .....	45
Poste et base pour chaîne .....	772
Poteau rabattable pour place parking .....	773
Poudre bleue pour marquage .....	190
Poulie avec tire-fond .....	844
Poulies .....	574
Pour cueillette longue portée .....	815
Poussoirs .....	130
Présentoir colliers .....	549
Présentoir couronne .....	499
Présentoir d'angle mural .....	877
Présentoir de peinture .....	639
Présentoir de pinces .....	110
Présentoir disques abrasifs .....	453
Présentoir électrique comptoir .....	717
Présentoir en panneau perforé .....	878
Présentoir gondole .....	876
Présentoir metal pour dynamometriques .....	138
Présentoir mètres .....	211
Présentoir modulaire .....	885
Présentoir perforé .....	875
Présentoir pour piles .....	681
Présentoir tournevis .....	100
Présentoirs .....	100-110-113-138-211-499-870
Programmateur horaire .....	689
Projecteur led portable a batterie .....	11-717
Projecteur led smd .....	717
Protecteur de câbles .....	774
Protection hydrofuge .....	630
Protection parking .....	773
Ptfe liquide .....	622
Pulverisateur dorsal .....	784
Pulverisateur inox .....	638
Pulvérisateur manuel .....	785
Pulvérisateurs .....	822
Punaises .....	775-851

## R

Rabots .....	185
Raccords en laiton .....	829
Raccords en tea .....	289
Raccords métalliques .....	266
Raccords plastiques .....	261
Raccords rapides .....	257
Raccords rapides grand debit .....	259
Raclette caoutchouc métallique industrielle .....	222
Raclor .....	203
Raises rotatives .....	506
Rallonge antenne .....	707
Rallonge électrique .....	705
Rallonge extensible pour peintre .....	658
Ramasse-feuille pliable .....	817
Rapes .....	188





Râteau.....	817	Set impresion chiffres - lettres.....	131	Tournevis avec 6 pointes.....	105
Râteau forgé.....	204	Set pour sanitaire wc.....	524	Tournevis pour colliers.....	550
Recipient pour huile usage.....	308	Siège de travail mobile.....	64	Traçeur de chantier fluorescent.....	638
Recouvre tache.....	637	Signaletique aimantee.....	879	Triangles panne.....	769
Réducteur de vitesse.....	774	Signalisation.....	732	Tronçonneuse.....	41
Réductions plastiques.....	457	Signalisation matières dangereuses.....	733	Truelle.....	192
Règles.....	214	Signalisation routière.....	763	Truelles.....	196
Reglette connexion.....	703	Silicone.....	616	Tube led.....	710
Reglette led.....	710	Sisal pita de 2 extrémités.....	603	Tube polyamide.....	291
Regulateur.....	826	Socle surface pour 1 element blanc.....	699	Tube pour toiles cirees et rouleaux.....	884
Renforce mousse.....	664	Soude caustique.....	645	Tuyau d'arrosage.....	830
Réparateur.....	826	Soudeur à l'étain.....	216	Tuyau hydro gris.....	821
Revetement pour facade en pierre.....	647	Souffleur à dos.....	33	<b>V</b>	
Riveteuse.....	534	Souffleuse électrique à batterie.....	13	Vérin de hayon.....	319
Riveteuse pneumatique.....	245	Spatule.....	195	Vernis.....	644
Rivets.....	536	Spray acrylique effet chrome.....	637	Vernis transparent.....	639
Robinet d'arrêt.....	286	Spray anti crevaisson.....	629	Verres de rechange pour souder.....	359
Robinet polyéthylène reservoir.....	310	Spray protection bornes de batterie.....	626	Veste de travail.....	381
Roue.....	223	Support.....	853	Veste polaire.....	389
Roue brouette chantier.....	229	Support chaine.....	582	Veste soft shell.....	390
Roue giratoire plate-forme avec frein.....	231	Support chaussure.....	883	Vêtements de pluie.....	392
Rouleau.....	653	Support de plastique et visière.....	365	Vetements haute visibilite.....	379
Rouleau de carton.....	664	Support de prix avec bande pour plateau.....	881	Vide fut a levier.....	311
Rouleau de filet tubulaire mousse élastique.....	666	Support film emballage.....	662	Vis à bois.....	857
Rouleau de film.....	666	Support jardiniere.....	788	Visière grillagée.....	365
Rouleau de papier "kraft".....	660	Support lampe rotative.....	769	Visserie.....	856
Rouleau de papier avec ruban.....	659	Support paroi pour tuyau.....	820	Visseuse pneumatique.....	251
Rouleau fibre de verre ravalements.....	662	Support pour perceuse.....	133	Vitrine magnétique avec fermeture.....	775
Rouleau fil galvanisé.....	608	Support pour soudeur à l'étain.....	216	<b>W</b>	
Rouleau filet tubulaire.....	667	Surchaussure.....	378	Waterproofing.....	649
Rouleau plastique bulle.....	667	Suspension blister adhésif.....	760	Workbench.....	78
Rouleau ruban ptfé.....	668	Sweat-shirt.....	388		
Rubalise.....	761	Synchroniseur d'irrigation mécanique.....	823		
Ruban adhésif.....	762	<b>T</b>			
Ruban adhésif acr.....	669	Table haute pliable.....	803		
Ruban adhésif de masquage.....	670	Table ovale.....	798		
Ruban adhésif double face.....	669	Table pliante carrée.....	802		
Ruban adhésif pour l'isolement.....	671	Table pliante rectangulaire.....	801		
Ruban adhésif pvc.....	668	Table ratan anthracite.....	799		
Ruban adhésif transparent.....	670	Table ronde pliante.....	802		
Ruban aluminium.....	669	Tableau aluminium pour signal.....	760		
Ruban store.....	591	Tableau en liège.....	775		
Rubans métrique.....	212	Tablier et manchettes de soudeur.....	360		
<b>S</b>		Tabouret alum.....	59		
Sac de jute.....	663	Tabouret pliant blanc.....	802		
Sacs de polymesh.....	663	Tachuela.....	851		
Sacs de rafia.....	663	Taille haies télescopique long.....	816		
Sangle.....	593	Taille-haie électrique à batterie.....	14		
Savon pour les mains.....	316	Taille-haie électrique longue portée a batterie.....	15		
Scellement synthétique.....	644	Tamis resine chimique.....	533		
Scie a bois.....	123	Tarauds.....	489		
Scie a chaine électrique à batterie.....	15	Tarauds rotatifs.....	494		
Scie a taille.....	813	Tee-shirt.....	391		
Scie circulaire.....	18	Temporisateur d'arrosage.....	824		
Scie cloche.....	503	Tenaille.....	117		
Scie de charpentier.....	125	Tenailles pour filtres d'huile.....	182		
Scie pneumatique.....	251	Tendeur.....	577		
Scie sauteuse.....	20-499	Tendeur à cliquet.....	595-811		
Scies a ruban.....	502	Tendeur grillage renforcé.....	817		
Séccateur a taille.....	814	Testeur electronique a mesure de tension.....	108		
Séparateur de clés.....	855	Testeurs de courant.....	107		
Serfouette.....	204	Têtes d'accouplement.....	286		
Serre joints.....	185	Thermostat de chauffage.....	689		
Serre pied.....	553	Tire-fonds.....	553		
Serre tubes suedoise.....	176	Toile anti-herbes.....	794		
Serre-câble en nylon.....	546	Tondeuse à gazon automotrice.....	31		
Serre-câbles.....	570	Tondeuse à gazon électrique avec roues.....	15		
Serrure.....	842	Tondeuse à gazon manuelle a batterie.....	14		
Serrure.....	424	Torche de signalement.....	769		
Serrure boîte aux lettres.....	844	Toriques spécifiques aux raccords d'irrigation.....	830		
Serrure électrique.....	430	Tourne a gauche.....	134-493		
Serrures persiennes.....	432	Tourne-à-gauche à 3 vis.....	494		
Set de tarauds et filieres.....	493	Tournevis.....	93		



<b>A</b>		
A-2 cable accessories .....	579	
Abrasive brush .....	511	
Abrasive discs .....	452	
Abrasive discs display stand .....	453	
Abrasive grinding wheels .....	457	
Acrylic spray paint .....	635	
Adapter for grease cartridge .....	301	
Adhesive blister hanger .....	760	
Adhesive circle .....	777	
Adhesive draught excluder .....	671	
Adhesive glue rodent .....	634	
Adhesive hooks .....	869	
Adhesive tape acr .....	669	
Adhesives - toxic waste .....	733	
Adjustable spanner .....	173	
Adjustable split die .....	493	
A-frame sign with text .....	750	
Air body saw .....	251	
Air drill .....	244	
Air duster .....	249	
Air engine cleaning gun .....	254	
Air filters .....	256	
Air hammer kit .....	245	
Air horn .....	632	
Air hydraulic riveter .....	245	
Air impact gun battery .....	12	
Air quick coupler .....	257	
Air quick coupler high volume .....	259	
Air tool kit .....	254	
Alkaline batteries .....	680	
Allen & torx wrenches .....	169	
Aluminium magnetic spirit level .....	208	
Aluminium stool ladder .....	59	
Aluminium tape .....	669	
Anchor rubber .....	817	
Angle grinder .....	244	
Angled shelf .....	881	
Antenna cable .....	708	
Antenna connector .....	707	
Antenna connector .....	707	
Antenna extension cable .....	707	
Antenna socket .....	707	
Anthracite rattan armchair .....	799	
Anthracite rattan table .....	799	
Antifreeze .....	314	
Anti-rust .....	638	
Anti-slip .....	631	
Anti-splashing funnel .....	309	
Anti-vibration gloves .....	342	
Apron and sleeves .....	360	
Arrow wall plug .....	522	
Artificial grass .....	790	
Ash vacuum cleaner battery .....	12	
Assortment heat shrink tubes .....	702	
Auto darkening helmet .....	360	
Auto start .....	630	
Automatic entrance gate .....	887	
Awning .....	797	
Axes .....	200	
<b>B</b>		
Back support belt with straps .....	376	
Backed tie mounts .....	547	
Backpack blower .....	33	
Backpack sprayer .....	784	
Bag of briquettes .....	806	
Ball valve .....	286	
Band saw blades .....	502	
Bar table cover .....	803	
Barbecues .....	805	
Barbed wire .....	609	
Basin wrench .....	181	
Baton light stick .....	770	
Battery 4r25 6v .....	769	
Battery charger .....	17-681	
Battery terminal protector .....	626	
Bearing set for wheelbarrow (2) .....	231	
Beige protective blanket .....	667	
Bench vice .....	133	
Big bag rubble .....	665	
Bi-metal hole saws .....	498	
Bipolar plug .....	683	
Bipolar plug socket .....	684	
Bipolar socket (kitchen plug) .....	684	
Bird netting .....	794	
Black tips .....	855	
Blind tips .....	846	
Block paint brush .....	652	
Blocks .....	846	
Blue beach chair .....	800	
Blue fertiliser .....	789	
Blue folding chair .....	800	
Bluetooth speaker .....	12	
Bolt cutters .....	122	
Braided polypropylene rope .....	598-601	
Braided rope .....	604	
Brake & clutch cleaner .....	627	
Brass calipers .....	209	
Brass spyhole .....	842	
Brass tap adapters .....	829	
Bricklayers .....	196	
Bright zinc .....	638	
Brooms .....	217	
Brush .....	652	
Brushes .....	650	
Bucket .....	658	
Building drills .....	474	
Bulb .....	322	
Bulb socket .....	687	
Bypass lopper .....	814	
<b>C</b>		
Cable protection ramp .....	774	
Calipers .....	209	
Cap mounted earmuffs .....	365	
Car jack stand .....	64	
Carbide tipped hole saws .....	496	
Cardboard box with carry handles .....	665	
Cardboard roll .....	664	
Caustic soda .....	645	
Centering drill bit .....	498	
Centre punch .....	130-207	
Chain .....	589	
Chain saw .....	43	
Chain straps .....	582	
Chainsaw .....	41	
Chair .....	798	
Chalk line .....	190	
Chemical anchor .....	533	
Chemical anchor mixer nozzle .....	533	
Chisels .....	206	
Chrome effect acrylic spray .....	637	
Circular saw .....	18	
Citronella lamp oil .....	808	
Clamps .....	185	
Clamps wall dispenser .....	549	
Cleaner .....	627	
Clear varnish .....	639	
Clothesline pulley with lag screw .....	844	
Cold chisel .....	206	
Color chart synthetic enamel .....	641	
Compasses .....	215	
Compressed air .....	249-266-631	
Compressors .....	242	
Concentrated plunger .....	632	
Cones .....	770	
Conic polyethylene funnel .....	309	
Connecting ring for chain post .....	772	
Connection board .....	703	
Connection plates .....	845	
Connectors .....	826	
Construction hollow core .....	503	
Construction signs .....	758	
Construction site mesh .....	662	
Construction tyre .....	229	
Contact adhesive .....	621	
Container pedal .....	790	
Containers .....	790	
Cooler box with handle .....	800	
Corde de polyamide .....	596	
Cordless angle grinder .....	9	
Cordless chainsaw .....	15	
Cordless hammer drill .....	8	
Cordless handheld hedge trimmer .....	14	
Cordless handheld hedge trimmer kit with adjustable handle and wheels .....	14	
Cordless impact wrench .....	8	
Cordless lawn mower with wheels .....	15	
Cordless multi-tool .....	9	
Cordless pole hedge trimmer .....	15	
Cordless screwdriver .....	8-10	
Cordless vacuum cleaner .....	10	
Cords .....	596	
Cork board .....	775	
Cork board cabinet .....	775	
Cotton ball .....	606	
Countersink drills .....	485	
Countersink drills .....	484	
Cover-up plastic foil .....	659	
Cranked wrench key ribe .....	172	
Crow-bar .....	190	
Curtain hooks .....	854	
Curved pitchforks .....	205	
Cut resistant glove .....	340	
Cutting discs .....	452	
Cutting fluid .....	624	
Cyanoacrylate .....	620	
Cyanoacrylate adhesive .....	620	
Cylinders .....	418	
<b>D</b>		
Desoldering pump with anti-static rubber nozzle ...	217	
Diamond core drills .....	503	
Diamond discs .....	458	
Die holders .....	494	
Digger pick .....	136	
Display stands .....	100-110-113-138-211-499-870	
Disposable gloves .....	350	
Door bolt .....	432-842	
Door closer .....	434	
Door handles .....	442	
Double blister hook .....	884	
Double faced tape .....	669	
Double grease gun high pressure professional ...	301	
Downlights .....	718	
Drawer knobs .....	845	
Drawstring polymesh bags .....	663	
Drill accessories .....	485	
Drill bit .....	497	
Drill case .....	473	
Drill clamps .....	133	
Drill set .....	465	
Drills for glass, ceramics and earthenware .....	479	
Drills for porcelain .....	481	
Drills for steel .....	466	
Drip irrigation .....	830	
Dripper .....	835	
Driver for hose clamps .....	550	
Drop in anchor plugs .....	531	
Dry cleaning .....	631	



<b>E</b>			
Ear plugs	366	Furrower kit	32
Earmuffs	366	<b>G</b>	
Earth clamp	47	Gaffer tape	670
Ecological industrial reel	658	Galvanised metal bracket sweeping brush	222
Elastic adjustable chin strap	365	Garden bucket with funnel	789
Elastic cords	600	Garden container	789
Elastic straps	607	Garden furniture	820
Electric cordless string trimmer	13	Gardening knife	129-813
Electric display	717	Gas spring	319
Electric grease gun	300	Generator	29-43
Electric grinder	22	Glasspack adhesive	756
Electric lock	430	Glue gun themofuse	234
Electric pumps	312	Glue gun themofuse stick	234
Electric strike lock	431	Gondola display	876
Electrical cable	702	Gondola pegboard panel	878
Electrical contact cleaner	627	Graffiti remover	630
Electrodes	48	Grease	625
Electronic embed mechanisms	691	Grease couplers	305
Electronic tester	108	Grease gun pneumatic	304
Elevation male ring	575	Grease guns prolube	302
Elevation welded ring	583	Greasers	306
Espositore erba artificiale	792	Great expansion plugs	521
Extendable pallet racking uprights	878	Grey water pipe	821
Extensible fence	771	Grill	804
Extensible handle for painter	658	Gun for silicone injection	619
Extension cable	705	<b>H</b>	
Extension cable reel	706	Hack saw	123
Extra long fixing plug	527	Hammer drill	24
Extra strong paint stripper	646	Hammerlock for chain	585
Extractors	134	Hammers	135
<b>F</b>		Hand saw, carpenter	125
Facade stone coating	647	Hand sign with aluminium handle	762
Faceshield	358	Hand soap	316
Fairlead spray	631	Hand tile cutters	190
Fasteners	856	Hand tool kits	83
Felt pads	855	Hand tool modules	67
Fibre discs	455	Hand truck	63
Files	186	Hand use transparent film	662
Film roll	666	Hand wet wipes	633
Fire extinguisher	633	Hard plastic adhesive	622
Firelighter	807	Hazardous material signs	733
Firewood trolley	806	Heat gun	21
Firmer chisels	185	Heating thermostat	689
Fishing mono-thread	606	Heavy duty ratchet wrench	247
Fixing	864	Helmet with ratchet	365
Fixing plugs	520	Hexagon shank	504
Fixing-plug	524	High plastic chain post	772
Flap discs	456	High temperature spray paint	639
Flaring tool	181	High visibility workwear	379
Flat tire fixer	629	Hinges	843
Fleece jacket	389	Hoe	203
Flexible grease hoses	305	Hoes	201
Flood detector	690	Hole saw for electromagnetic drill	495
Floor cover fleece with foil-coating	660	Hole saws display stand	499
Floor masking paper "kraft"	660	Hollow punches	131
Fluorescent marking spray	638	Hook	374-572-843
Foam	666	Hook of direct access to the chain	584
Foam corner	664	Hook wrench	183
Fogging kit	819	Hose clamps	547
Foldable bench	801	Hose clamps case	552
Foldaway parking post	773	Hose hanger	820
Folding bar stool	803	Hose kit	819
Folding bar table	803	Hose mender	826
Folding rake	817	Hose ree	255-820
Footwear holder	883	Hoses	255-818
Forge effect varnish	642	Hot-dipped galvanised wire	608
Forged rake	204	Hot-dipped welded wire mesh	608
Frame hooks	851	Hydraulic jack	64
Freeze effect rust breaker	623	Hydraulic oil	317
Fruit pruners	809	<b>I</b>	
Funnel with filter for fuel	308	Impact gun	247
		Impact spanners	159
		Imperméable	649
		Impregnated gloves	344
		Industrial metal squeegee	222
		Industrial plug	686
		Insulating gloves	339
		Inverter welding machine	45
		Iron effect painting	637
		Irrigation tube	830
		<b>J</b>	
		Jack planes	185
		Jig saw	20-499
		Jump leads	320
		Jute bags	663
		Jute twine reel	602
		<b>K</b>	
		Kee pads	376
		Kit composed of grommets and washers	132
		Kit for enamel paint	658
		Kit training	433
		Knife	127
		Kraft bubble padded envelopes	664
		<b>L</b>	
		Laboratory coats	391
		Ladder	58
		Lag screws	553
		Lamp (revolving light)	769
		Lampholder cable	716
		Landscape fabric	794
		Laser distance meter	214
		Latex coated gloves	347
		Latex gloves	348
		Latex pvc	349
		Leather gloves	336
		Led bulb	711
		Led headlight	721
		Led lamp	710
		Led strip	710-718
		Led tube	710
		Letter boxes	445
		Level indicator for tap	310
		Lever action barrel pump	311
		Lifeline	375
		Lifting chain	583
		Lifting eye hook with latch	585
		Lighter fluid	808
		Li-ion cordless hedge trimmer	14
		Li-ion cordless leaf blower	13
		Linseed oil	645
		Lithium grease	625
		Load bar	882
		Lock shield	431
		Locks	843
		Locks for hose clamps	548
		Locks for rolling shutters	433
		Long plug with screw	526
		Long reach harvester	815
		Long reach pruner	816
		Loose fill chips	665
		Lubricant	623
		Lubrication	868
		Luggage combination padlock	441
		<b>M</b>	
		Magnetic welding holder	217
		Magnetic whiteboard cabinet	775
		Magnetizer - demagnetizer	105
		Mannequin	887
		Manual grease gun for cartridge	301
		Manual sprayer	785
		Marking blue powder	190



Masking foil with adhesive tape.....	659	Pilot pin for electromagnetic drill.....	494
Masking paper krepp + "kraft".....	660	Pin punches.....	130
Masking tape.....	670	Pincers.....	117
Mattock.....	203	Pipe cutter.....	177
Measuring tape.....	210	Pipe cutter for hose.....	180
Measuring tape exhibitor.....	211	Pipe reamer.....	176
Mechanic creeper.....	64	Pipe wrench.....	175
Mechanical water timer.....	823	Pipeseal.....	622
Metal battery display stand.....	681	Pistol grease gun.....	303
Metal cleaner.....	627	Pitchforks.....	205
Metal display for torque wrenches.....	138	Plactic lever pump.....	313
Metal mesh & wire.....	608	Planter hanger.....	788
Metal wedge/firewood.....	206	Plasterboard plug.....	523
Metallic bolts.....	528	Plastic "s" hook for chain.....	772
Metallic fittings.....	266	Plastic bracket and visor.....	365
Metallic pipe clamps.....	553	Plastic bubble roll rotolo.....	667
Mills case.....	510	Plastic cable clamp.....	703
Mini electric circular saw.....	19	Plastic chain.....	772
Mini grease pump.....	304	Plastic compartment toolbox.....	74
Mini trunking accessories.....	699	Plastic electrical tape.....	668
Mirrors.....	776	Plastic fittings.....	261-457
Mobile work seat.....	64	Plastic fixing plug.....	520
Modular counter.....	885	Plastic foil.....	661
Monocappa scraper.....	192	Plastic hang strips for blister.....	872
Mops.....	222	Plastic key separators.....	855
Mortise lock.....	424	Plastic mesh.....	795
Motor hoe.....	32	Plastic painting.....	647
Multibit screwdriver.....	11	Plastic rope reel.....	602
Multiple gang switch.....	704	Plastic sidewinder.....	846
Multi-pocket body warmer.....	389	Plastic snap hook for chain.....	772
Multi-socket adaptor plug.....	684	Plastic tube cutter.....	292
<b>N</b>		Pliers.....	108
Nails.....	233	Pliers exhibitor.....	110
Neoprene and nitrile gloves.....	349	Plug adapter with dual usb ports.....	685
Netting roll.....	667	Plug for scaffold fixing plug.....	527
Nonslip strips.....	672	Plumbers hemp.....	606
Nonslip tape.....	762	Pneumatic die grinder.....	244
Nozzle.....	824	Pneumatic nailer.....	253
Nutlock.....	622	Pneumatic stapler.....	252
Nylon and cotton gloves.....	339	Pneumatic stapler/nailer.....	252
Nylon cable tie.....	546	Pocket scriber.....	216
<b>O</b>		Polo shirt.....	390
Oil.....	315	Polyamide tubes.....	291
Oil filter wrench.....	182	Polycarbonate grease feeder.....	307
Oil filter wrench claw type.....	182	Polyester anchorage ring.....	527
Oil for cutting and drilling.....	624	Polyethylene tap container.....	310
Oil pump portable.....	300	Polymer sealant.....	617
Oil used container.....	308	Polypropylene twist.....	596
Oiler lubricator accessory.....	254	Polyurethane foam.....	618
O-rings.....	560	Polyurethane foam cleaner.....	619
O-rings special for watering by sprinklers connectors.....	830	Polyurethane putty.....	618
Outer micrometer.....	213	Polyurethane tubes.....	292
Oval dining table.....	798	Portable inspection camera.....	65
Overalls.....	386	Portable led work light battery-operated.....	11-717
<b>P</b>		Postbox lock.....	844
P.P. Adhesive tape.....	670	Pressure washer.....	40
Padlock key blank.....	439	Price holder with shelf strip.....	881
Padlocks.....	437	Professional hedge shears.....	812
Paint for swimming pools.....	649	Professional oil can.....	308
Paint remover "gel".....	646	Professional torque wrench.....	138
Paint roller.....	653	Professional tyre inflator gauge.....	250
Palm coupling adapter.....	286	Protective drops.....	855
Panic devices.....	435	Protective frame.....	756
Paper cord reel.....	602	Pruning saw.....	813
Parking protection.....	773	Ptfe thread seal tape.....	668
Particulate respirator.....	362	Pulleys.....	574
Pegboard display stand.....	875	Pure turpentine.....	643
Pegboard hook.....	883	Pvc adhesive tape.....	668
Pegboard hook with label holder.....	883	Pvc glue.....	621
Peic screwdrivers.....	251	<b>Q</b>	
Penetrating oil.....	623	Quick dis-connect grease coupler.....	305
		Quick-setting cement.....	634
		<b>R</b>	
		Raffia sacks.....	663
		Rainboots.....	402
		Rainwear.....	392
		Rake.....	817
		Ral colour chart.....	636
		Rasp.....	188
		Ratchet pruning shears.....	812
		Ratchet snip.....	121
		Ratchet straps.....	593-595
		Rechargeable batteries.....	681
		Rechargeable battery.....	16
		Rectactable belt barrier.....	771
		Rectangular folding table.....	801
		Red lead.....	643
		Reflective oblique straps.....	765
		Reflective paint.....	638
		Regulator.....	826
		Removable film.....	636
		Re-sharpening hole saws.....	497
		Reversible chain wrench.....	183
		Revolving light.....	766
		Revolving wheel for scaffolding with brake.....	231
		Rigid steel extension.....	305
		Ring for chains.....	582
		Rivet caps.....	543
		Rivet nuts.....	544
		Riveting.....	534
		Rivets.....	536
		Roll fibreglass mesh for rendering.....	662
		Rotary hammer sds-plus.....	26
		Rotatory bomb for oil and fuel.....	311
		Rotatory eye bolt.....	584
		Round clamp.....	843
		Round folding table.....	802
		Round string trimmer line.....	34
		Rubber bipolar plug.....	683
		Rubber plug socket.....	683
		Ruler.....	214
		Rust-proof enamel.....	643
		<b>S</b>	
		Safe.....	441
		Safety cone.....	750
		Safety folding goggles.....	358
		Safety footwear.....	396
		Safety glasses.....	352
		Safety harness.....	367
		Safety rope for harness.....	370
		Sandpapers.....	463
		Sanitiser.....	629
		Saw blades.....	125-251
		Scaffold eyebold.....	527
		Scissors.....	120
		Screw bits.....	87
		Screw extractors.....	134-493
		Screwdriver display stand.....	100
		Screwdriver with 6 bits.....	105
		Screwdrivers.....	93
		Screws.....	857
		Scythe handle.....	204
		Sealant putty.....	617
		Seeger rings.....	554
		Self drilling plug.....	523
		Self propelled lawn mower.....	31
		Set for toilet wc.....	524
		Set of hole saws.....	499
		Shade netting green.....	792
		Shelf kit.....	881
		Shelving.....	61
		Shield anchor.....	527
		Shoe cover.....	378
		S-hook.....	588



Shopping basket.....	888	Synthetic enamel.....	640	Water based paint.....	647
Shovels.....	199	Synthetic engine oil.....	315	Water pump petrol engine.....	36
Sign posts.....	732	Synthetic primer.....	643	Water repellent.....	630
Signposting lamp.....	769	Synthetic raffia bent threads.....	604	Water trap.....	828
Silicone.....	616	Synthetic sealant.....	644	Water-based mastic.....	648
Silicone dashboard cleaner.....	628	<b>T</b>		Watering timer.....	824
Sinalização magnetizada.....	879	Tacks.....	775-851	Weld on hook.....	584
Sleeve chemical anchor.....	533	Tap adapter.....	828	Welded ring.....	571
Sling.....	592	Tap wrench.....	494	Welding earth clamp with cable kit.....	47
Small items.....	842	Tape blind.....	591	Welding electrode holder.....	47
Small load plugs for hollow materials.....	521	Tape measures.....	212	Welding electrode holder with cable kit.....	47
Smd led projector.....	717	Tape.....	489	Welding helmet.....	359
Smoke detector.....	690	Taps.....	489	Welding splash remover.....	630
Snap.....	587	Taps and dies kits.....	493	Wheel wrenches.....	184
Socks.....	395	Tea screw fittings.....	289	White adhesive.....	621
Softshell jacket.....	390	Teak oil.....	645	White folding chair.....	801
Soldering iron.....	216	Telephone flat cable.....	708	White folding stool.....	802
Spare glasses for welding.....	359	Telescopic joint inspection mirror.....	216	Whiteboard magnets.....	775
Spare part revolving light.....	768	Telescopic joint pick up pocket clip.....	216	Window planter and saucer.....	788
Spark plug wrench.....	184	Thick soap for hands.....	316	Windscreen cleaner.....	314
Special chainsaw oil.....	43	Thickness gauge.....	213	Windscreen wiper.....	318
Special sloping shelf with brackets.....	881	Thimble.....	571	Wire basket with 5 dividers for displays.....	880
Special starter rope.....	601	Thread pitch gauge.....	213	Wire mesh.....	365
Speed bump.....	774	Threaded tap connector for garden.....	827	Wire netting.....	608
Spindle with drill.....	498	Timer switch time clock socket.....	689	Wire rope clip.....	570
Spiral twisted cord.....	597	Tire inflator gauge.....	250	Wire tightener.....	817
Split dies.....	490	Tool box.....	71	Wood dowel pins.....	854
Split pin.....	557	Tool lanyard.....	82	Wood drills.....	482
Sports working cap.....	365	Tool panel.....	78	Wooden discs.....	461
Spray adhesive.....	631	Tool pouch.....	71-82	Wooden handle.....	205-220-817
Spray display stands.....	639	Tool trolley.....	66	Work jacket.....	381
Spray gun.....	637	Torches.....	719	Work lamp.....	321
Sprinklers.....	822	Torque replicator kit.....	168	Work overalls.....	378
Square.....	213-845	Tow skein.....	606	Work shorts.....	379
Square folding table.....	802	Traffic signs.....	763	Workbench.....	78
Square socket + ground connection.....	687	Trowel.....	195	Working footwear.....	408
St. Tip plated.....	850	Trowel.....	192	Working trousers.....	380
Stain covering paint.....	637	Trowel.....	191	Wrenches.....	139
Stainless flexible connection pipe.....	288	T-shirt.....	391	<b>Y</b>	
Stainless steel barbecue.....	804	Tube bender.....	181	Yellow suction hose roll with spiral reinforcement.....	821
Stainless steel cable.....	589	Tube kit for oilcloths and rolls.....	884		
Stainless steel grass shears.....	812	Twine thread. Hemp.....	605		
Stainless steel skewer.....	804	Twist holder.....	547		
Stainless steel spray.....	638	Twist nozzle with adaptor.....	825		
Stapler.....	231	Twisted polyester.....	605		
Staples.....	233	Twisted polypropylene rail.....	596		
Steel post hole diggers.....	206	Twisted strands plastic rope.....	605		
Steel stamps numbers - letters.....	131	Tyre.....	223		
Stillson wrenches.....	175	Tyre lever.....	134		
Stoning hammer.....	136	Tyre polisher.....	628		
Stoning hammer - flower pot.....	135-787	<b>U</b>			
Storage bin.....	75-80	U-bolt fastener.....	588		
Straight arm.....	882	Umbrella bag dispenser.....	888		
Straight shackles.....	576	Universal arm.....	882		
Straight shank rotaries.....	506	Universal disolvent.....	646		
Strand sisal rope (2).....	603	Universal wall back box 5-gang tube.....	698		
Strap wrench.....	182	<b>V</b>			
Stretch foam netting roll.....	666	Varnish.....	644		
String trimmer blade.....	35	Vaseline spray.....	625		
String trimmer petrol engine.....	34	Vegetable/plant knife with container.....	813		
Struttura per segnale in alluminio.....	760	Vertical grease gun for cartridge.....	302		
Stucco plaster.....	634	Voltage testers.....	107		
Sturt.....	577	Vulcanizable tape.....	671		
Submersible electric pump.....	37	<b>W</b>			
Suction gun.....	304	Wall bracket.....	849		
Support for revolving lights.....	769	Wall corner gondola shelving.....	877		
Supports.....	853	Wall frame hangers.....	851		
Surface back box.....	699	Warning tapes.....	761		
Surface box.....	701	Warning triangle.....	769		
Sweatshirt.....	388	Watch battery.....	682		
Swedish pipe wrench.....	176	Water based enamel.....	642		
Swing hook.....	531				
Switch.....	687				
Swivel handle oil filter wrench.....	182				





<b>A</b>			
Accessori canalina .....	699	Bobina di carta asciugatutto .....	658
Accessori per cavi inox. A-2 .....	579	Bobina filo juta .....	602
Accessori per giardino .....	820	Bobina filto di cotone .....	606
Accessori per trapano .....	485	Bocche di ingrassaggio .....	305
Accessorio lubrificatore .....	254	Boccola ad espansione .....	531
Adattatore multipresa .....	684	Bolle di protezione .....	855
Adattatore per cartuccia grasso .....	301	Bollino adesivo .....	777
Adattatore presa con 2 porte usb .....	685	Bordini in schiuma .....	664
Adattatore rubinetto .....	828	Braccio .....	882
Adattatori in ottone .....	829	Braccio universale .....	882
Adesivi residui - tossici .....	733	Brillantante per pneumatici .....	628
Adesivo a contatto .....	621	Bulini .....	130
Adesivo cianoacrilato .....	620	Bulloni a u. ....	588
Adesivo per plastica dura .....	622	Buste carta kraft imbottite a bolle d'aria .....	664
Adesivo per pvc .....	621	<b>C</b>	
Adesivo spray .....	631	Cacciavite .....	550
Altoparlante bluetooth .....	12	Cacciavite con 6 punte .....	105
Ammortizzatore pneumatico .....	319	Cacciaviti .....	93
Ancorante chimico .....	533	Calamite per lavagna magnetica .....	775
Ancorina a bascula con occhiolo aperto .....	531	Calibri .....	209
Anelli in gomma .....	817	Calibro .....	209
Anello ancoraggio poliestere .....	527	Calzature da lavoro .....	408
Anello di collegamento catena-coni .....	772	Calzature di sicurezza .....	396
Anello di sospensione .....	583	Calzini .....	395
Anello girevole .....	584	Camice .....	391
Anello per catena .....	582	Cappellino di protezione .....	365
Anello saldato .....	571	Caricabatterie .....	17
Anello seeger .....	554	Caricabatterie per pile .....	681
Antenna .....	707	Carrelli .....	63
Antiadesivo per saldature .....	630	Carrelli per utensili .....	66
Antigelo .....	314	Carrucole .....	574
Antiossidante .....	638	Carta abrasiva .....	463
Antipanico .....	435	Casco da cantiere .....	365
Antiruggine sintetico .....	643	Cassetta di sicurezza .....	441
Antiscivolo .....	631	Cassetta per attrezzi .....	71
Appendiquadri .....	851	Cassetta porta punte .....	473
Apriporta elettrico .....	431	Cassetta postale .....	445
Aria compressa .....	249-266-631	Cassetto .....	75-80
Artiglio metallico galvanizzato per spazzolone .....	222	Catena .....	583-589
Asce .....	200	Catena da motosega .....	43
Aspira cenere batteria .....	12	Catena in plastica .....	772
Aspiratore a batteria .....	10	Catena sega elettrica a batteria .....	15
Assortimento tubi termoretraibili .....	702	Cavalletto .....	64
Avviamento rapido .....	630	Cavalletto di segnalazione .....	750
Avvitatore a batteria .....	8-10	Cavi di avviamento .....	320
Avvitatore elettrico multipunta .....	11	Cavo antenna .....	708
Avvitatori lineari pneumatici .....	251	Cavo elettrico .....	702
Avvolgicavo elettrico .....	706	Cavo in acciaio inox. ....	589
Avvolgitore nastro .....	846	Cavo piatto telefono .....	708
Avvolgitubo con tubo .....	255-820	Cazzuole .....	196
<b>B</b>		Cellophane protettivo .....	659
Bacheca chiusa in sughero .....	775	Cemento rapido .....	634
Bacheca chiusa magnetica .....	775	Cercafase .....	107
Bande oblique riflettenti .....	765	Cerniere .....	843
Barbecue .....	805	Cerniere rotonde .....	843
Barra di carico .....	882	Ceselli di legno .....	185
Barriera estensibile .....	771	Cesoia tagliatubi .....	180
Base e palo per catena .....	772	Cesoie per lamiere .....	121
Base multipla prese .....	704	Cestello a 5 divisori per espositori .....	880
Base per fascette .....	547	Cestino di acquisto .....	888
Bastone luminoso di segnalazione .....	770	Chiave .....	175
Batteria a bottone .....	682	Chiave a catena reversibile .....	183
Batteria ricaricabile .....	16	Chiave a cinghia .....	182
Batterie ricaricabili .....	681	Chiave di impatto .....	247
Battiscopa per 1 elemento bianco .....	699	Chiave di impatto batteria .....	12
Bermuda da lavoro .....	379	Chiave dinamometrica professionale .....	138
Big bag macerie .....	665	Chiave filtri autoregolabili .....	182
Blister gancio adesivo .....	760	Chiave lavabo .....	181
Bloccante .....	622	Chiave regolabile .....	173
Blocco parcheggio .....	773	Chiave regolabile per filtro olio .....	182
Bobina corda intrecciata .....	604	Chiave smontaggio pneumatici .....	134
		Chiave vuoto per lucchetto .....	439
		Chiavi .....	139
		Chiavi a gancio .....	183
		Chiavi a percussione .....	159
		Chiavi allen e torx .....	169
		Chiavi ribe curve .....	172
		Chiavi ruota .....	184
		Chiavi stillson .....	175
		Chiavi svedesi .....	176
		Chiavistello .....	432
		Chiodatrice pneumatica .....	253
		Chiodi .....	233
		Chiodini .....	851
		Chips riempimento .....	665
		Chiudiporta .....	434
		Cianoacrilati .....	620
		Cilindros .....	418
		Cinghia .....	592
		Cinghia con ganci portapacchi .....	811
		Cintura lombare .....	376
		Colla bianca .....	621
		Collanti .....	864
		Coltellino pieghevole per innesti .....	129-813
		Compassi .....	215
		Compressori .....	242
		Concime granulare blu .....	789
		Coni .....	770
		Connettore antenna .....	707
		Connettore filettato per giardino .....	827
		Connettore per antenna .....	707
		Connettore per irrigazione .....	828
		Connettori .....	826
		Cono 4 lati .....	750
		Contafiletto .....	213
		Contentore a vista .....	701
		Contentore ad incastro per meccanismi .....	698
		Contentore per legna .....	806
		Contentore porta attrezzi .....	71-82
		Contentori .....	790
		Coperta protettiva .....	667
		Copertura protettiva plastificata per suolo .....	660
		Copri tovaglia .....	803
		Coprimacchia .....	637
		Corda di plastica ritorta .....	605
		Corda elicoidale intrecciata .....	597
		Corda in plastica .....	602
		Corda in poliammide .....	596
		Corda in poliestere .....	605
		Corda intrecciata in polipropilene .....	598-601
		Corda speciale di avviamento .....	601
		Corde .....	596
		Corde elastiche .....	600-607
		Corde in polipropilene .....	596
		Cordino anticaduta .....	82
		Corona da costruzioni .....	503
		Corona in metallo duro .....	496
		Corona trapano elettromagnetico .....	495
		Corone bimetalliche .....	498
		Corone riaffilabili .....	497
		Corpo ancorante .....	527
		Cric idraulico .....	65
		Cricchetto pneumatico .....	247
		Cuffie antirumore .....	366
		Cuffie anti-rumore .....	365
		Cuneo in metallo/legno .....	206
		Cuscinetti supporto ruota per carriola (2) .....	231
		<b>D</b>	
		Dado a rivetto .....	544
		Decapante extraforte .....	646
		Decespugliatore a benzina .....	34
		Decespugliatore elettrico a batteria .....	13
		Detergente parabrezza .....	314
		Detergente per cruscotto .....	628
		Dischi abrasivi .....	452
		Dischi da taglio .....	452



Dischi diamantati .....	458
Dischi in fibra vulcanizzata .....	455
Dischi laminati .....	456
Dischi pour le legno .....	461
Disgorgante detergente .....	632
Disossidante per contatti elettrici .....	627
Disossidante sbloccante .....	623
Display stands .....	100-110-113-138-211-499-870
Dispositivo tendicinghia .....	595
Distributore di sacchetti ombrello .....	888
Divisorio a nastro estensibile .....	771
Doppio gancio per blister .....	884
Downlights .....	718

## E

Elettrodi .....	48
Elettropompa sommergibile .....	37
Espositore angolare .....	877
Espositore cacciaviti .....	100
Espositore con pannello forato .....	878
Espositore corone .....	499
Espositore da banco per batterie .....	681
Espositore dischi abrasivi .....	453
Espositore elettrico .....	717
Espositore fascette .....	549
Espositore forato .....	875
Espositore gondola .....	876
Espositore in metallo per dinamometri .....	138
Espositore metri .....	211
Espositore modulare .....	885
Espositore pinze .....	110
Espositori per marcatori .....	639
Essenza di trementina .....	643
Estrattore viti .....	134-493
Estrattori .....	134

## F

Faretto led portatile a batteria .....	11-717
Faro da lavoro .....	321
Fascetta ad arco .....	553
Fascetta di nylon .....	546
Fascette .....	547
Felpa con colletto .....	388
Feltrini .....	855
Fermacavo piano .....	570
Fili di rafia sintetica .....	604
Filiere .....	490
Filiere regolabile .....	493
Film imballo .....	661
Filo canapa .....	605
Filo lenza .....	606
Filo metallico e reti metalliche .....	608
Filo spinato .....	609
Filo tondo per decespugliatore .....	34
Filtri aria .....	256
Fissastrice pneumatica .....	252
Fissatore elastico .....	365
Fissatore in plastica .....	703
Fissastrice pneumatica .....	252
Flangiatubo .....	181
Forbice decespugliatrice .....	812
Forbice per potature .....	814
Forbice tagliasiepi professionale .....	812
Forbici .....	120
Forbici raccolta .....	809
Forche .....	205
Forche curve .....	205
Foretti diamantati .....	503
Frattazo .....	192
Frattonne lama .....	191
Fresatrice pneumatica .....	244
Frese rotative .....	506
Frigorifero portatile con manico .....	800
Fune di sicurezza per imbracatura .....	370

## G

Ganci di piccole dimensioni .....	851
Ganci per tende .....	854
Gancio .....	584
Gancio a "s" per catena in plastica .....	772
Gancio a s doppio aperto .....	588
Gancio applicabile saldabile .....	584
Gancio autoadesivo .....	869
Gancio di sollevamento con sicurezza a molla .....	585
Gancio fioriera .....	788
Gancio per pannello forato .....	883
Gancio per pannello forato con portaprezzo .....	883
Generatore .....	29-43
Giacca da lavoro .....	381
Giacca polare .....	389
Giacca softshell .....	390
Gilet imbottito multitasche .....	389
Ginocchio .....	376
Gira femmina .....	494
Giramaschio .....	494
Giubbini catarifrangenti .....	379
Giunti torici .....	560
Glasspack adesivo .....	756
Gocciolatore .....	835
Golfare .....	575
Gommini chiavi .....	855
Gonfiagomme professionale .....	250
Graffette .....	233
Grasso .....	625
Grasso al litio .....	625
Grasso di vaselina spray .....	625
Griglie .....	804
Grilli dritti .....	576
Guanti antivibrazione .....	342
Guanti cuoio .....	336
Guanti di nylon e cotone .....	339
Guanti impregnati in cotone .....	344
Guanti in latex .....	348
Guanti in lattice rugoso .....	347
Guanti in neoprene e nitrile .....	349
Guanti in pvc .....	349
Guanti isolanti .....	339
Guanti monouso .....	350
Guanto antitaglio .....	340
Guarnizione adesiva .....	671
Guarnizioni toriche per irrigatori .....	830
Guida cavo .....	571

## H

Hammerlock per catena .....	585
-----------------------------	-----

## I

Ice sblocc spaccaruggine .....	623
Idropulitrice alta pressione .....	40
Idrorepellente .....	630
Igienizzante .....	629
Imballaggio plastico a bolle .....	667
Imbragatura anticaduta .....	367
Imbuto anti-spruzzo .....	309
Imbuto conico in polietilene .....	309
Imbuto travasatore con filtro .....	308
Impermeabilizzante .....	649
Indicatore di livello per rubinetto .....	310
Indicazione per il lavoro .....	758
Ingrassaggio .....	868
Ingrassatori .....	306
Ingrassatrice elettrica .....	300
Iniettore di lubrificante .....	304
Innesto tubolare per lampeggiante .....	769
Interruttore .....	687
Intonaco .....	634
Irrigatore a goccia .....	830
Irrigatori .....	822

Irroratore spray .....	784
------------------------	-----

## K

Kit componenti e ammaestramento .....	433
Kit d'assolcatore .....	32
Kit moltiplicatore di giri .....	168
Kit morsetto di massa con cavo .....	47
Kit nebulizzatore .....	819
Kit occhielli .....	132
Kit pinza porta elettrodo con cavo .....	47
Kit pistole ad aria .....	254
Kit smalto .....	658
Kit strumenti a mano .....	83
Kit tagliasiepi a mano estensione e ruote a batteria .....	14
Kit tubo .....	819

## L

Lama per decespugliatore .....	35
Lame seghetto .....	125-251
Lampada di segnalazione .....	769
Lampadina .....	322
Lampadina globo déco .....	716
Lampadina (sirena lampeggiante) .....	769
Lampadina led .....	710
Lampeggiante .....	766
Lancia con apertura regolabile .....	825
Lavagna in sughero .....	775
Lavamani .....	316
Lettino sottomacchina .....	64
Limes .....	186
Linea di gesso .....	190
Linea vita .....	375
Liquido accensione .....	808
Livella magnetica .....	208
Lubrificante .....	623
Lubrificatore automatico in policarbonato .....	307
Lucchetti .....	437
Lucchetto da viaggio con combinazione .....	441
Luce led .....	721

## M

Maglia antierba .....	794
Maglia di unione catena in plastica .....	772
Maglia rapida .....	587
Magnetizzatore - smagnetizzatore .....	105
Manichino .....	887
Manico estensibile rullo .....	658
Manico falce cofan .....	204
Manico film imballo .....	662
Manico in legno .....	205-220-817
Manico per martelli .....	504
Manicotto di riparazione .....	826
Maniglie .....	442
Manometro e pompa .....	250
Marcatore da cantiere fluorescente .....	638
Martelli .....	135
Martinetto idraulico .....	64
Maschera da saldatura .....	359
Maschera di saldatura automatica .....	360
Mascherina .....	362
Maschi .....	489
Mastice di fissaggio .....	617
Mastice poliuretano .....	618
Materiale piccolo .....	842
Mazza .....	136
Mazzeta - vasi per fiori .....	135-787
Meccanismi elettrici .....	691
Metro flessibile .....	210
Micrometri per esterni .....	213
Mini pompa per grasso .....	304
Mini sega circolare elettrica .....	19
Minio di piombo .....	643
Miscelatore ancorante chimico .....	533
Misuratore laser di distanze .....	214



Mocio industriale.....	222	Pistola termocollante.....	234	Raschietto.....	203
Moduli attrezzatura.....	67	Pistole ad aria.....	249	Raspa.....	188
Moldura de alluminio para sinal.....	760	Pistole per vernici.....	250	Rastrello.....	817
Moli abrasive.....	457	Pittura plastica.....	647	Rastrello forgiato.....	204
Montante estendibile per scaffale.....	878	Placche di unione.....	845	Regolatore di pressione.....	826
Morsa da banco.....	133	Polimero fissante.....	617	Rete.....	608
Morse per trapano da banco.....	133	Polo.....	390	Rete antiuccelli.....	794
Morsetti.....	185	Poltrona rattan antracite.....	799	Rete di segnalazione cantieri.....	662
Morsetto connessione.....	703	Polvere azzurra per tracciatura.....	190	Rete elettrosaldata.....	608
Morsetto di massa.....	47	Pomelli.....	845	Rete in plastica.....	795
Moschettone.....	374-572	Pompa di ingrassaggio a leva.....	302	Rete protettiva verde.....	792
Motopompa a benzina.....	36	Pompa di travaso a leva.....	311	Ricambio cristalli saldatura.....	359
Motosega.....	41	Pompa in plastica a leva.....	313	Ricambio sirena lampeggiante.....	768
Motozappe.....	32	Pompa ingrassaggio doppia, alta pressione, professionale.....	301	Riduzioni in plastica.....	457
<b>N</b>		Pompa ingrassaggio manuale per cartuccia.....	301	Righelli.....	214
Nastri metriche.....	212	Pompa ingrassaggio pneumatica.....	304	Rilevatore acustico.....	632
Nastro acr.....	669	Pompa ingrassaggio verticale per cartuccia.....	302	Rilevatore di fumo.....	690
Nastro adesivo.....	670	Pompa per grasso portatile.....	300	Rilevatore di inondazione.....	690
Nastro adesivo antiscivolo.....	762	Pompa rotativa per olio e combustibile.....	311	Rimuovi graffiti.....	630
Nastro adesivo in pvc.....	668	Pompe elettriche.....	312	Ripara pneumatici.....	629
Nastro adesivo trasparente.....	670	Pompetta per dissaldare.....	217	Ripiano.....	881
Nastro adesivo vulcanizzato.....	671	Portalamпада.....	687	Ripiano angolare.....	881
Nastro americano.....	670	Portaprezzi con striscia per ripiano.....	881	Ripiano per scarpe.....	883
Nastro biadesivo.....	669	Portello meccanico.....	887	Ripiano speciale inclinato con supporti.....	881
Nastro canapa.....	606	Potatrice ad ampio raggio.....	816	Rivestimento per facciata in pietra.....	647
Nastro di alluminio.....	669	Prato sintetico.....	790	Rivettatrice.....	534
Nastro di avvertimento.....	761	Presa bipolare (cucina).....	684	Rivettatrice pneumatica.....	245
Nastro isolante.....	668	Presa per spina bipolare.....	684	Rivetto.....	536
Nastro tapparella.....	591	Presa per spina in gomma.....	683	Roloto tubo spiralato giallo.....	821
<b>O</b>		Presa quadrata superficie con connessione a terra.....	687	Rotoli in plastica con nastro.....	659
Occhiali di sicurezza.....	352	Presa rapida grande portata d'aria.....	259	Rotolo cartone.....	664
Occhiali protettivi.....	358	Prese rapide.....	257	Rotolo di carta "kraft".....	660
Oliatore a pressione professionale.....	308	Programmatore orario.....	689	Rotolo di carta krepp + "kraft".....	660
Olio.....	315	Proiettore led smd.....	717	Rotolo film.....	666
Olio alla citronella.....	808	Prolunga antenna.....	707	Rotolo filo zincato.....	608
Olio da taglio.....	624	Prolunga elettrica.....	705	Rotolo nastro ptfе.....	668
Olio da taglio e filettatura.....	624	Protezione antifurto.....	431	Rotolo protezione schiuma elastica.....	666
Olio di lino.....	645	Protezione braccia e gembrule.....	360	Rotolo rete in fibra di vetro.....	662
Olio di teak.....	645	Protezione calzature.....	378	Rotolo rete tubolare.....	667
Olio idraulico.....	317	Protezione cavi elettrici.....	774	Rubinetto polietilene per fusti.....	310
Olio sintetico per motore.....	315	Protezione morsetti batteria.....	626	Rullo.....	653
Olio speciale per catena motosega.....	43	Ptfe liquido.....	622	Ruota.....	223
<b>P</b>		Puleggia con tirafondo.....	844	Ruota per carrello.....	229
Pale.....	199	Pulitore.....	627	Ruota rotante perno con freno.....	231
Palo pieghevole per parcheggio.....	773	Pulitore di freni e frizioni.....	627	<b>S</b>	
Panca pieghevole.....	801	Pulitore per metalli.....	627	Sacchetto bricchetti.....	806
Pannello portautensili.....	78	Pulitore schiuma poliuretana.....	619	Sacchi di iuta.....	663
Pantalone da lavoro.....	380	Punta di centraggio.....	498	Sacchi di rafia.....	663
Paracolpi di sicurezza.....	773	Punta guida.....	497	Sacchi di rete.....	663
Pedale per pattumiera.....	790	Punta in acciaio.....	850	Saldatore in stagno.....	216
Pellicola rimovibile.....	636	Punta per tracciare tascabile.....	216	Saldatrice inverter.....	45
Pennellessa.....	652	Punte da costruzione.....	474	Salviettine detergenti per mani.....	633
Pennelli.....	650	Punte in acciaio.....	466	Sapone per le mani.....	316
Pennello.....	652	Punte per avvitatori.....	87	Scaffali.....	61
Perni legno.....	854	Punte per legno.....	482	Scala.....	58
Perno serraggio.....	842	Punte per porcellana.....	481	Scalpelli.....	206
Pialla.....	185	Punte svasatrici.....	484	Scalpello pneumatico.....	245
Piccone per scavare.....	136	Punte trapano per vetro, ceramica e gres.....	479	Scatola in cartone con maniglie per trasloco.....	665
Piede di porco.....	190	Puntine.....	775-851	Scavabuchi in acciaio.....	206
Pila 4r25 6v.....	769	Punzone.....	207	Scheda colori ral.....	636
Pile alcaline.....	680	Punzone trapano elettromagnetico.....	494	Schermo di protezione.....	358
Pinza per barbecue.....	804	Punzoni.....	131	Schiuma foam.....	666
Pinza porta elettrodi.....	47	Punzoni.....	130	Schiuma poliuretano.....	618
Pinzatrice.....	231	Punzoni lettere - numeri.....	131	Scopa regolabile.....	817
Pinze.....	108	<b>R</b>		Sedia.....	798
Pistola ad aria calda.....	21	Raccogliatore a lungo raggio.....	815	Sedia pieghevole.....	801
Pistola ad aria per lavaggio motore.....	254	Raccorderia metallica.....	266	Sedia poltrona pieghevole.....	800
Pistola d'irrigazione.....	824	Raccordi in plastica.....	261	Sedia sgabello bar.....	803
Pistola di ingrassaggio ad una mano.....	303	Raccordi tea.....	289	Sedie da spiaggia pieghevole.....	800
Pistola per bombolette spray.....	637	Rallentatori di velocita'.....	774	Sedile da lavoro mobile.....	64
Pistola per silicone.....	619	Rapida disconnessione.....	305	Sega a cinghia.....	502
		Raschiatore monostrato.....	192	Sega per potatura.....	813
				Sega pneumatica.....	251



Seghetto ad arco .....	123	<b>T</b>	Tubo per acqua grigio .....	821	
Seghetto alternativo .....	20-499	Tabella dei colori smalto sintetico .....	641	Tubo per tele cerate e rotoli .....	884
Seghetto falegname .....	125	Tabliapiastrelle .....	190	Tuta da lavoro .....	386
Segnale stradale .....	763	Taglia ghiaccio .....	206	Tute di protezione da lavoro .....	378
Segnaletica .....	732	Tagliabarre .....	122	<b>U</b>	
Segnaletica magnetica .....	879	Tagliaerba semovente .....	31	Ugello nero .....	855
Segnaletica manuale con manico in alluminio .....	762	Tagliasiepi a mano con batteria .....	14	Universal solvent .....	646
Segnaletica materiali pericolosi .....	733	Tagliasiepi elettrico a batteria .....	14	Utensile multiuso a batteria .....	9
Serra circolare .....	18	Tagliasiepi elettrico con ruote .....	15	<b>V</b>	
Serratura .....	424	Tagliasiepi telescopico a batteria .....	15	Valigetta contenente fascette metalliche .....	552
Serratura di bloccaggio .....	844	Tagliatubi .....	177-292	Valigetta in plastica scomparti .....	74
Serratura elettrica .....	430	Taglierina .....	122-127	Valvola sfera .....	286
Serrature per fascette .....	548	Taglierino con serbatoio .....	813	Vasca recupero olio esausto .....	308
Serrature per persiane .....	433	Tapi per orecchie .....	366	Vaschetta .....	658
Set corone riaffilabili .....	499	Tappi arresto serrande .....	846	Vaso e sottovaso .....	788
Set frese rotative .....	510	Tappi per rivetti .....	543-846	Vaso giardinaggio .....	789
Set maschi e filiere .....	493	Tappo per tassello per impalcature .....	527	Vaso giardinaggio con sottovaso .....	789
Set per sanitario wc .....	524	Taselli autoforanti .....	523	Vassoio barbecue monouso .....	807
Set punte .....	465	Tassello .....	520	Vernice .....	644
Sgabellone in alluminio .....	59	Tassello ad espansione .....	521	Vernice acrilica .....	635
Sgabellone pieghevole bianco .....	802	Tassello extra lungo .....	527	Vernice ad acqua .....	647
Sigillante sintetico .....	644	Tassello fissaggio .....	521	Vernice alta temperatura .....	639
Silicone .....	616	Tassello in plastica .....	520	Vernice catarifrangente .....	638
Sirena lampeggiante .....	767	Tassello lungo con vite .....	526	Vernice per piscine .....	649
Sisal pita di 2 fili .....	603	Tassello metallico .....	528	Vernice spray, effetto ferro antico .....	637
Smacchiatore .....	631	Tassello per ancorante chimico .....	533	Vernice trasparente .....	639
Smalto all'acqua .....	642	Tassello per cartongesso .....	522	Vestiti impermeabili .....	392
Smalto antiossidante .....	643	Tassello per piccoli pesi su materiali vuoti .....	521	Visiera grigliata .....	365
Smalto metallico .....	642	Tassello rapido .....	524	Viteria .....	856
Smalto sintetico .....	640	Tavolino pieghevole alto .....	803	Viti ad occhiello per impalcature .....	527
Smerigliatrice a batteria .....	9	Tavolo da lavoro .....	78	Viti per legno .....	857
Smerigliatrice elettrica .....	22	Tavolo ovale .....	798	<b>Z</b>	
Snodata, da candele .....	184	Tavolo quadrato pieghevole .....	802	Zappa doppia .....	204
Soda caustica .....	645	Tavolo rattan antracite .....	799	Zappe .....	201
Soffiatore a zaino .....	33	Tavolo rettangolare pieghevole .....	801	Zappeta .....	203
Soffiatore elettrico a batteria .....	13	Tavolo rotondo pieghevole .....	802	Zinco chiaro .....	638
Spatola .....	195	Telaio di protezione .....	756		
Spazzola abrasiva .....	511	Telecamera endoscopica a colori .....	65		
Spazzola metallica lavavetri industriale .....	222	Telescopio a specchio per ispezioni snodato .....	216		
Spazzola tergitristallo .....	318	Telescopio prensibile con clip tascabile .....	216		
Spazzolone .....	217	Telescopio snodato per ispezioni a specchio .....	216		
Specchi .....	776	Tenaglia curvatubi .....	181		
Spegnifiamma .....	633	Tenaglia per filtro olio .....	182		
Spessimetri .....	213	Tenaglie .....	117		
Spiedini inossidabili .....	804	Tenda da sole .....	797		
Spina bipolare .....	683	Tendicinghia .....	593		
Spina in gomma bipolare .....	683	Tenditore .....	577		
Spina industriale .....	686	Tenditore tendifilo .....	817		
Spine .....	557	Tensore a cricchetto .....	595		
Spioncino in ottone .....	842	Termostato riscaldamento .....	689		
Spola corda di carta .....	602	Teste di accoppiamento .....	286		
Spray acrilico effetto cromato .....	637	Tester elettronico misura tensione .....	108		
Spray inox .....	638	Timer meccanico per irrigazione .....	823		
Spray passacavi .....	631	Timer per l'irrigazione .....	824		
Spruzzatore manuale .....	785	Tirafondi .....	553		
Squadra .....	213-845	Tiranti a catena .....	582		
Squadra magnetica per saldatura .....	217	Torçe .....	719		
Staffa di plastica e supporto visiera .....	365	Trapano a percussione .....	24		
Stick di colla termofusibile .....	234	Trapano a percussione, a batteria .....	8		
Stivale di gomma .....	402	Trapano battente sds-plus .....	26		
Stoppa di canapa speciale .....	606	Trapano pneumatico .....	244		
Strisce antiscivolo .....	672	Trappola adesiva per roditori .....	634		
Strisce porta blister in plastica .....	872	Treccia in polipropilene .....	596		
Striscia led .....	710-718	Triangolo di avaria .....	769		
Stucco plastico all'acqua .....	648	T-shirt .....	391		
Supporti .....	853	Tubi .....	255-818		
Supporto a muro per tubi flessibili .....	820	Tubi in poliammide .....	291		
Supporto fascetta .....	547	Tubi poliuretano .....	292		
Supporto parete .....	849	Tubo di ingrassaggio flessibili .....	305		
Supporto portacorona con punta .....	498	Tubo di ingrassaggio rigido curvo .....	305		
Svasatore .....	176	Tubo flessibile .....	288		
Sverniciatore "gel" .....	646	Tubo irrigazione .....	830		
		Tubo led .....	710		



<b>A</b>		
Abocardador.....	181	
Abraçadeira metálica.....	553	
Abraçadeira tubo métrico de cobre.....	703	
Abraçadeiras.....	547	
Abraçadeiras de nylon.....	546	
Abreportas eléctrico.....	431	
Abrilhantador de pneus.....	628	
Acendalha líquida.....	808	
Acendalhas.....	807	
Acessório lubrificante.....	254	
Acessórios para berbequim.....	485	
Acessórios para cabos de inos a-2.....	579	
Acessorios para mini-calha.....	699	
Acoplador rápido.....	257	
Acoplador rápido grande caudal.....	259	
Acoplamentos.....	286	
Adaptador cartucho lubrificante.....	301	
Adaptador de antena.....	707	
Adaptador hexagonal.....	504	
Adaptador multi-via.....	684	
Adaptador p/torneira.....	828	
Adaptador para tomada eléctrica + 2 saídas usb.....	685	
Adaptador serra craneana com broca.....	498	
Adaptadores de rosca para jardim.....	827	
Adaptadores em latão.....	829	
Adubo azul para plantas e flores.....	789	
Agrafador pneumático.....	252	
Agrafadores.....	231	
Agrafos.....	233	
Aguarrás pura.....	643	
Alavanca pé de cabra.....	190	
Alguidar recipiente de jardim.....	789	
Alicate de massa.....	47	
Alicate para filtros de óleo.....	182	
Alicates.....	108-117	
Alicates curvabutos.....	181	
Alimentador de lubrificante policarbonato.....	307	
Almotolia.....	254	
Almotolia profissional.....	308	
Altavoz bluetooth a bateria.....	12	
Ancinho.....	817	
Ancinho forjado.....	204	
Anéis de retenção.....	560	
Anéis de retenção especiais para irrigação.....	830	
Aneis seeger.....	554	
Anel conector para cones.....	772	
Anel de elevação soldável.....	583	
Anilha de ancoragem.....	527	
Anilha soldada.....	571	
Anti-adesivo para soldagem.....	630	
Anticongelante.....	314	
Antideslizante.....	631	
Antipânico.....	435	
Apaga chamas.....	633	
Aparafusador a bateria.....	8-10	
Aparafusador eléctrico multipontas.....	11	
Aparafusador impacto.....	24	
Aparafusador pneumático.....	251	
Ar comprimido.....	249-266-631	
Arame farpado.....	609	
Arames e redes metálicas.....	608	
Arnés anticaída.....	367	
Aspersores.....	822	
Aspirador a bateria.....	10	
Aspirador de cinzas a bateria.....	12	
Auriculares de proteção auditiva.....	366	
Autoarranque.....	630	
Autocolante resíduos-tóxicos.....	733	
Avental e mangas para soldagem.....	360	
<b>B</b>		
Balde de jardinagem com bico.....	789	
Bancada de trabalho.....	78	
Banco desdobrável retangular.....	801	
Banco móvel para mecânico.....	64	
Banco/escadote de alumínio.....	59	
Banco/escadote desdobrável.....	802	
Bandeja especial inclinada com suportes.....	881	
Barbecues.....	805	
Barra.....	882	
Barra de cola termofusível.....	234	
Base bipolar (tomada cozinha).....	684	
Base de antena.....	707	
Base modular quadrada (telefone).....	693	
Base multiplas tomadas.....	704	
Base para bridas.....	547	
Base quadrada de superfície + tomada de terra.....	687	
Base tomada aérea borracha.....	683	
Base tomada bipolar aérea.....	684	
Bata.....	391	
Batente persiana.....	846	
Batentes.....	846	
Bateria 4r25 6v.....	769	
Bateria recarregável.....	16	
Berbequim aparafusador a bateria.....	8	
Berbequim de percussão com bateria.....	8	
Berbequim pneumático.....	244	
Bico de lubrificação de alta pressão com conexão rápida.....	305	
Bico regulável.....	825	
Bicos de lubrificação.....	305	
Big bag escombros.....	665	
Bit's para parafusar.....	87	
Bloqueio de parking.....	773	
Bobine corda de papel.....	602	
Bobine fio de juta.....	602	
Bobine industrial ecológica.....	658	
Bolsa porta-ferramentas.....	71-82	
Bomba de lubrificação com alavanca.....	302	
Bomba de lubrificação de uma mão.....	303	
Bomba de lubrificação dupla alta pressão profissional.....	301	
Bomba de lubrificação manual para cartuchos.....	301	
Bomba de lubrificação pneumática.....	300-304	
Bomba de lubrificação vertical de cartucho.....	302	
Bomba de massa eléctrica.....	300	
Bomba dessoldagem com bico de borracha anti-estática.....	217	
Bomba plástica de alavanca.....	313	
Bomba rotativa para óleo e combustível.....	311	
Bomba transferência alavanca.....	311	
Bombas de lubrificação.....	306	
Bombas eléctricas.....	312	
Boné de proteção.....	855	
Boné de segurança.....	365	
Borrachas de ancoragem.....	817	
Botas de água.....	402	
Briquetes de carvão.....	806	
Broca de aço.....	466	
Broca de centrar.....	498	
Broca escareadora.....	484	
Broca guia.....	497	
Broca para construção.....	474	
Broca para vidro, cerâmica e grés.....	479	
Broca porcelânica.....	481	
Brocas escareadoras.....	485	
Brocas para madeira.....	482	
Bucha auto-perfurante.....	523	
Bucha borboleta com perno.....	531	
Bucha com alas.....	520	
Bucha de expansão por golpe.....	531	
Bucha de golpe rápido.....	524	
Bucha extra larga.....	527	
Bucha longa com parafuso.....	526	
Bucha metálica.....	528	
Bucha para abraçadeira.....	547	
Bucha para pladur.....	523	
Bucha plástica.....	520	
Bucha química.....	533	
Bucha seta.....	522	
Buchas de fixação.....	521	
Buchas de grande expansão.....	521	
Buchas pequenas cargas.....	521	
Buscapolos.....	107	
<b>C</b>		
Cabalete com texto.....	750	
Cabalete macaco hidráulico.....	64	
Cabide.....	882	
Cabo de aço.....	589	
Cabo de antena.....	708	
Cabo de madeira.....	205-220-817	
Cabo eléctrico.....	702	
Cabo extensível de pintor.....	658	
Cabo para gadanha.....	204	
Cabo para lâmpada decorativa.....	716	
Cabo plano para telefone.....	708	
Cabos de bateria.....	320	
Caçonetes ajustáveis.....	493	
Cadeado com código para malas.....	441	
Cadeados.....	437	
Cadeira alta desdobrável.....	803	
Cadeira de ratan antracite.....	799	
Cadeira desdobrável branca.....	801	
Cadeira desdobrável fixa lacado fibreline azul.....	800	
Cadeira/cama de praia fibreline azul com asa de alumínio.....	800	
Cadeiras.....	798	
Caixa abraçadeiras.....	552	
Caixa de armanejamento.....	75-80	
Caixa de cartão para mudanças asa troquel.....	665	
Caixa de ferramentas.....	71	
Caixa de superfície.....	701	
Caixa encastrar mecanismo tubo.....	698	
Caixa forte.....	441	
Caixas de correio.....	445	
Caixas de plástico.....	74	
Calçado de segurança.....	396	
Calçado de trabalho.....	408	
Calças de trabalho.....	380	
Calções de trabalho.....	379	
Calibrador fracionário.....	209	
Calibrador pneumático profissional.....	250	
Calibradores.....	209	
Calibradores de espessura.....	213	
Câmara de inspeção portátil.....	65	
Camisara.....	388	
Cançnete de roscar.....	490	
Cantoneiras de espuma.....	664	
Capacete de proteção.....	365	
Capacete de soldadura automática.....	360	
Carregador de bateria.....	17	
Carregador de pilhas.....	681	
Carrinho.....	63	
Carrinho para lenha.....	806	
Carro de ferramentas.....	66	
Carta de cores esmaltes sintéticos.....	641	
Carta de cores ral.....	636	
Cartazes para obras.....	758	
Casaco polar.....	389	
Casaco soft shell.....	390	
Casacos de trabalho.....	381	
Cavadeira de aço.....	206	
Cavilha de madeira.....	854	
Cerca extensível.....	771	
Cerra cabos.....	570	
Cesto 5 espaços para expositores.....	880	
Cesto de compras com rodas.....	888	
Chave ajustável para filtros de óleo.....	182	
Chave de correia.....	182	
Chave de corrente reversível.....	183	





Chave de fenda com 6 pontas compridas sortidas ..	105	Corta cabos .....	122	Expositor canto parede .....	877
Chave de fendas .....	93	Corta relvas de autopropulsão .....	31	Expositor de alicates .....	110
Chave de fendas flexível para abraçadeiras .....	550	Corta relvas de mão a bateria .....	14	Expositor de chave de fendas .....	100
Chave de gancho .....	183	Corta relvas elétrico com rodas .....	15	Expositor de fitas métricas .....	211
Chave de impacto .....	159-247	Corta tubos .....	177	Expositor de metal para chave de torque-binário ..	138
Chave de lavatório .....	181	Corta-cabos .....	122	Expositor de pilhas .....	681
Chave de torque-binário profissional .....	138	Cortador de azulejos manual .....	190	Expositor elétrico .....	717
Chave de velas de ignição .....	184	Cortador de tubo de plástico .....	292	Expositor gôndola .....	876
Chave filtros auto regulável .....	182	Corta-frios .....	206	Expositor p/ abraçadeiras .....	549
Chave modelo sueco .....	176	Corta-sebes elétrico a bateria .....	14	Expositor para serras craneanas .....	499
Chave para rodas .....	184	Corta-sebes elétrico de longo alcance a bateria ..	15	Expositor perfurado .....	875
Chave para tubo .....	175	Cueca polar .....	159	Expositor vertical perfurado .....	878
Chave ribe curva .....	172	Cunha metal lenha .....	206	Expositores .....	100-110-113-138-211-499-870
Chave stillson .....	175	<b>D</b>		Expositores de tinta .....	639
Chaves .....	139	Decapante extra forte .....	646	Extensão da coluna .....	878
Chaves ajustáveis .....	173	Desandador de machos .....	494	Extensão elétrica .....	705
Chaves allen e torx .....	169	Desandador para caçonetes .....	494	Extensão rígida e curva .....	305
Chaves em bruto para cadeados .....	439	Desentupidor líquido .....	632	Extensão telescópica magnética com clip para bolso ..	216
Chips de recheio .....	665	Desmonta pneus .....	134	Extratores .....	134
Cianocrilato .....	620	Desoxidante .....	627	Extratores de parafusos .....	134-493
Cilindros .....	418	Desoxidante para contactos elétricos .....	627	<b>F</b>	
Cimento rápido .....	634	Detector eletrônico de tensão .....	108	Faca de recoleção com depósito .....	813
Cinta de aperto sem roquete .....	593	Detetor de fumos .....	690	Faca desdobrável de enchertia .....	129-813
Cinta de queixo elástico .....	365	Detetor de inundações .....	690	Faixa led .....	718
Cintas de aperto com roquete .....	595	Discola laminados .....	456	Fato de trabalho .....	321
Cintas de aperto com roquete reforçada .....	817	Discos abrasivos .....	452	Fato-de-macaco .....	378
Cinturão de trabalho com alças .....	376	Discos de corte .....	452	Fatos de água .....	392
Cinzel .....	206	Discos de diamante .....	458	Fatos de trabalho .....	386
Círculo autocolante .....	777	Discos para pedra .....	461	Fechadura elétrica .....	430
Cizalha .....	121	Discos vulcanizados .....	455	Fechadura persianas .....	433
Cizalha para cebes profissional .....	812	Dispensador de film manual .....	662	Fechaduras .....	424
Cobertura sapatos .....	378	Dispensador de sacos para guarda chuvas .....	888	Fechaduras de caixa de correio .....	844
Cola branca .....	621	Display de discos abrasivos .....	453	Fechaportas .....	434
Cola contacto .....	621	Display para corta relvas artificial .....	792	Fecho .....	557
Cola de cianoacrilato .....	620	Dobradiça redonda .....	843	Fecho culatra .....	842
Cola em spray .....	631	Dobradiças .....	843	Fechos .....	843
Cola para pvc .....	621	Downlights .....	718	Fechos para abraçadeiras .....	548
Cola para roedores .....	634	<b>E</b>		Feltro .....	855
Cola plásticos rígidos .....	622	Elérobomba submersível .....	37	Ferrolho .....	432
Colector de rega .....	828	Eléttodos .....	48	Film embalagem .....	661
Colete multibolsos .....	389	Elo para corrente .....	582	Filtros de ar .....	256
Coletor de óleo usado .....	308	Engate para mangueira .....	826	Fio de ráfia sintética .....	604
Colhedor de longo alcance .....	815	Enrolador de cabo .....	706	Fio de sediela .....	606
Colheres para construção .....	196	Enrolador de mangueira .....	255-820	Fio marcador .....	190
Compassos .....	215	Envelope kraft com bolha .....	664	Fio redondo para motorçoçadora .....	34
Compressores .....	242	Enxada .....	203	Fio torcido polipropileno .....	596
Cone com 4 lados .....	750	Enxadas .....	201	Fita adesiva acrílica .....	669
Conector de antena .....	707	Equipamento para jardim .....	820	Fita adesiva com papel .....	660
Conectores .....	826	Escadas .....	58	Fita adesiva com pvc .....	668
Cones .....	770	Escovas .....	511	Fita adesiva crílica transparente .....	670
Conexão flexível inox .....	288	Escova abrasiva .....	318	Fita americana .....	670
Conjunto martelo pneumático .....	245	Escova limpa para-brisas .....	217	Fita antidesslizante .....	762
Conjunto parteleira .....	881	Escovas para madeira .....	185	Fita de alumínio .....	669
Conjunto tubo p/ rolos .....	884	Escudo anti-broca .....	431	Fita de cânhamo .....	606
Conjuntos de serras craneanas .....	499	Eslinga .....	592	Fita de persiana .....	591
Conta fios .....	213	Esmalte á base de água .....	642	Fita dupla cara .....	669
Contentores .....	790	Esmalte anti-oxidante .....	643	Fita isolante de pvc .....	668
Corão entrençado hippie .....	604	Esmalte forja .....	642	Fita métrica .....	210
Corda antiqueda .....	82	Esmaltes sintéticos .....	640	Fita papel "crepe" .....	670
Corda de segurança para arnés .....	370	Espátulas .....	195	Fita vedaportas .....	671
Corda elástica .....	600	Espelho telescópico articulado .....	216	Fita vulcanizável .....	671
Corda entrençada helicoidal .....	597	Espelhos .....	776	Fitas antiderrapantes .....	672
Corda entrençada polipropileno .....	598	Espeto inoxidável .....	804	Fitas de sinalização .....	761
Corda especial de arranque .....	601	Espuma de limpeza de poliuretano .....	619	Fitas métricas .....	212
Corda plástica torcida .....	605	Espuma de poliuretano .....	618	Fixação em blister .....	864
Corda trançada de polipropileno .....	596	Espuma foam .....	666	Fixador e vedante .....	622
Cordão entençado polipropileno .....	601	Esquadro magnético para soldar .....	217	Floreira e prato .....	788
Cordas .....	596	Esquadros .....	213-845	Foco led portátil a bateria .....	11-717
Cordel cânhamo .....	605	Estantes .....	61	Formões .....	185
Corpo fixação .....	527	Esteira de mecânico .....	64	Forquilha .....	205
Corrente .....	589	Esticador .....	577	Forquilhas .....	205
Corrente de elevação .....	583	Esticadores elásticos .....	607	Fresadora pneumática .....	244
Corrente de motosserra .....	43			Fresas rotativas .....	506
Corrente de plástico .....	772				



Funil anti-salpicos .....	309	Lâmpada de sinalização .....	769	Mesa redonda desdobrável .....	802
Funil com filtro para combustível .....	308	Lâmpada h1 (luz giratória) .....	769	Micrômetro para exteriores .....	213
Funil de cone polietileno .....	309	Lâmpada led .....	711	Mini bomba de óleo com botão .....	304
Furador .....	131	Lâmpada led .....	710	Mini serra circular elétrica .....	19
<b>G</b>		Lanterna .....	719	Minio de chumbo .....	643
Galvanização a frio .....	638	Lava-mãos .....	316	Misturador de bucha química .....	533
Gancho .....	843	Limas .....	186	Módolo de ferramenta .....	67
Gancho "s" corrente plástica .....	772	Limpa para brisas .....	314	Moldura abs .....	756
Gancho adesivo .....	869	Linga de corrente .....	582	Moldura de alumínio para sinal .....	760
Gancho adesivo em blister .....	760	Linha de vida .....	375	Mopa de limpeza .....	222
Gancho com seguro alta resistência .....	585	Lixas .....	463	Mós abrasivas .....	457
Gancho de redes .....	588	Lomba redutora velocidade .....	774	Mosqueteo de plástico para corrente .....	772
Gancho em blíster puplo .....	884	Lubrificador .....	868	Mosqueteo//mosqueteo .....	374-572
Gancho encurtador acesso direto para a corrente .....	584	Lubrificante .....	623-623	Mostrdor modular .....	885
Gancho para floreira .....	788	Lubrificante de lítio .....	625	Motobomba a gasolina .....	36
Gancho pequeno .....	851	Luvas anticorte .....	340	Motoenxada .....	32
Gancho simples .....	883	Luvas antivibración .....	342	Motorroçadora a gasolina .....	34
Gancho simples com etiqueta .....	883	Luvas de latex .....	348	Motorroçadora elétrica a bateria .....	13
Gancho soldável .....	584	Luvas de latex rugoso .....	347	Motoserra .....	41
Gancho universal .....	882	Luvas de neopreno e nitrilo .....	349	Multiferramenta com bateria .....	9
Ganchos para cortinas .....	854	Luvas de nylon e algodão .....	339	<b>N</b>	
Garra de metal galvanizado escova de varrer .....	222	Luvas de pel .....	336	Níveis .....	208
Gel passa cabos em spray .....	631	Luvas de pvc .....	349	Novelo de algodão .....	606
Geladeira térmica rígida com asa .....	800	Luvas descartáveis .....	350	<b>O</b>	
Gerador .....	29-43	Luvas impregnadas .....	344	Óculos de proteção dobrável .....	358
Gesso para estuque .....	634	Luvas isolantes .....	339	Óculos de segurança .....	352
Glasspack adesivo .....	756	Luz giratória .....	766	Óleo .....	315
Gotejador .....	835	Luz giratória de substituição .....	768	Óleo citronela .....	808
Grampeador/agrafador pneumático .....	252	Luz led .....	721	Óleo de corte ( refrigerante) .....	624
Grampo plástico cabo .....	703	Luzes auto .....	322	Óleo especial correntes motoserra .....	43
Grampo tipo "u" .....	588	<b>M</b>		Óleo fino de vaselina .....	625
Grampos .....	185	Macaco de rodas .....	64	Óleo hidráulico .....	317
Grampos para perfuração .....	133	Macaco hidráulico .....	65	Óleo linhaça .....	645
Grelhas .....	804	Machados .....	200	Óleo para corte e aparafusadora .....	624
Grosas .....	188	Machos de enroscar .....	489	Óleo penetrante .....	623
Guardacabos .....	571	Magnetizador-desmagnetizador .....	105	Óleo sintético para motor .....	315
<b>H</b>		Mala de brocas surtidas .....	473	Óleo teka .....	645
Hammerlock (elo de ligação) para corrente .....	585	Mala de ferramentas .....	83	Olhal de suspensão .....	575
Higienizante .....	629	Malha anti-ervas .....	794	Olhal para mola pneumática .....	319
<b>I</b>		Malha anti-pássaros .....	794	Olhal rotativo de elevação .....	584
Imã para quadro .....	775	Malha de ocultação .....	792	<b>P</b>	
Impermeabilizante .....	649	Malha de sinalização .....	662	Painel porta ferramentas .....	78
Indicador de nível para saída .....	310	Malha elétrico-soldada .....	608	Pampões de ouvidos .....	366
Injetor de valvulina .....	304	Malha plástica .....	795	Parafuso ancoragem andaimes .....	527
Interruptor aereo .....	687	Malha rápida .....	587	Parafusos .....	857
<b>J</b>		Manequins .....	887	Parafusos com rosca .....	553
Joelheiras .....	376	Mangueiras .....	255-818	Parafusos em blister .....	856
Jogo de 2 rolamentos para carrinho de mão .....	231	Manilha .....	576	Pás .....	199
Jogo de brocas .....	465	Manivelas .....	442	Passador de esfera c/ aspe femea/femea .....	286
Jogo de fresas rotativas .....	510	Manômetro e insuflador .....	250	Pedal para recipiente .....	790
<b>K</b>		Manta protectora .....	667	Película removível .....	636
Kit alicate de masa com cabo .....	47	Manta protectora para chão plastificada .....	660	Peneira nylon bucha química .....	533
Kit chave de rodas .....	168	Marcador spray fluorescente .....	638	Penetrante efeito gelo saca pernos .....	623
Kit corta-sebes de mão extensível com rodas a bateria .....	14	Marreta .....	136	Pequeno material .....	842
Kit de esmalter .....	658	Marreta//vaso .....	135-787	Perfuradores .....	130
Kit de igualamento e amaestrador de cilindros .....	433	Martelo perfurador .....	26	Picadeira .....	136
Kit de ilhós .....	132	Martelo pneumático .....	253	Pilha botão .....	682
Kit de machos e caçonetes .....	493	Martelos .....	135	Pilhas alcalinas .....	680
Kit de nebulização .....	819	Máscara de soldadura .....	359	Pilhas recarregáveis .....	681
Kit de tiras oblíquas reflexivas .....	765	Máscaras .....	362	Pinça de churrasco .....	804
Kit ferramenta pneumática .....	254	Massa plástica base água .....	648	Pinça porta eletrodos .....	47
Kit mangueiras .....	819	Massa poliuretano .....	618	Pincel .....	652
Kit moto-enxada .....	32	Massa seladora .....	617	Pionéses .....	775-851
Kit porta eletrodos com cabo .....	47	Meada de corda plástica .....	602	Pistola de ar .....	249
<b>L</b>		Meada de estopa .....	606	Pistola de ar quente .....	21
Lamina de motorroçadora .....	35	Mecanismos elétricos .....	691	Pistola de cola termofusível .....	234
Lâminas de serra .....	125-251	Medidor de distâncias laser .....	214	Pistola de impacto .....	12
		Meias .....	395	Pistola de injetar silicone .....	619
		Mesa alta desdobrável .....	803	Pistola de pintar .....	250
		Mesa de ratan antracite .....	799	Pistola de rega .....	824
		Mesa desdobrável quadrada .....	802	Pistola para latas de spray .....	637
		Mesa desdobrável retangular .....	801		
		Mesa oval .....	798		



Placa de união.....	845	Rolo de cartão.....	664	Tacha.....	851
Plástico cobre tudo.....	659	Rolo de film.....	666	Talocha.....	191
Pó azul para marcação.....	190	Rolo de fita ptfe.....	668	Tampa para bucha de andaimes.....	527
Podador de longo alcance.....	816	Rolo de malha de fibra de vidro.....	662	Tampa para rebites.....	543
Polímero selante.....	617	Rolo de malha tubular de espuma.....	666	Temporizador de rega.....	824
Polos.....	390	Rolo de malha tubular.....	667	Temporizador.....	689
Ponteira preta.....	855	Rolo de papel "kraft".....	660	Termóstato de aquecimento.....	689
Ponteiro.....	207	Rolo de plástico bolha.....	667	Tesoura corta mangueiras.....	180
Porcas de cravar.....	544	Rolo de plástico com fita cola.....	659	Tesoura corta relva.....	812
Porta de acesso mecânico.....	887	Rolo de tubo em espiral de aspiração.....	821	Tesoura de podar.....	809
Porta preços com faixa para prateleira.....	881	Rolos.....	653	Tesouras.....	120
Poste abatível para parking.....	773	Roquete para armação.....	595	Tesouras de catraca.....	811
Poste de plástico para correntes.....	772	Roquete pneumático 1/2".....	247	Tesouras de poda.....	814
Poste fita extensível.....	771	Roupa de grande visibilidade.....	379	Tinta resistente ao calor.....	639
Prateleira angular.....	881	<b>S</b>		Tinta á base de água.....	647
Pregos.....	233	Sabão de mão.....	316	Tinta acrílica efeito cromado.....	637
Pregos de aço.....	850	Sacho.....	204	Tinta cobre manchas.....	637
Primário antioxidante.....	638	Saco de juta.....	663	Tinta efeito forja.....	637
Primário sintético.....	643	Sacos de polimesh.....	663	Tinta em spray.....	635
Projektor led smd.....	717	Sacos de rafia.....	663	Tinta para piscinas.....	649
Prolongação de antena.....	707	Saída polietileno recipiente.....	310	Tinta plástica.....	647
Proteção para cabos.....	774	Sdissolvente universal.....	646	Tinta refletiva.....	638
Proteção de impacto.....	773	Selante sintético.....	644	Tiras de plástico para pendurar blister.....	872
Protetor auditivo.....	365	Separador de chaves.....	855	Toalhitas para limpeza.....	633
Protetor mesa.....	803	Serra circular.....	18	Tolde.....	797
Protetor terminais de bateria.....	626	Serra craneana berbequim eletromagnético.....	495	Tomada bipolar.....	683
Ptfe líquido.....	622	Serra craneana bimetálica.....	498	Tomada bipolar de borracha.....	683
Pulverizador manual.....	785	Serra craneana diamantada.....	503	Tomada industrial móvel.....	686
Pulverizador mochila.....	784	Serra craneana diamante.....	503	Torno de bancada.....	133
Punção berbequim eletromagnético.....	494	Serra craneana metal duro.....	496	Trançado poliamida.....	596
Punções.....	130	Serra craneana para construção.....	503	Trançado poliéster.....	605
Punções de números - letras.....	131	Serra de arco.....	123	Triângulo de advertência.....	769
Puxador.....	845	Serra de corrente elétrica a bateria.....	15	Trincha canária.....	652
<b>Q</b>		Serra de fita.....	502	Trinchas.....	650
Quadro de cortiça.....	775	Serra de podar.....	813	Tshirt.....	391
<b>R</b>		Serra pneumática.....	251	Tubagem de poliamida.....	291
Raccord metálico.....	266	Serra tico-tico.....	20-499	Tubagem de poliuretano.....	292
Raccord plástico.....	261	Serras craneanas afiadas.....	497	Tubagem hidro certificada cor cinza.....	821
Raccord tea.....	289	Serrote carpinteiro.....	125	Tubo de lubrificação flexível.....	305
Rascador de capa única.....	192	Set para sanitário wc.....	524	Tubo de rega gota-a-gota.....	830
Raspadeira.....	203	Silicone.....	616	Tubo led.....	710
Rebarbador.....	176	Sinal de mão com cabo em alumínio.....	762	<b>V</b>	
Rebarbadora a bateria.....	9	Sinalética magnetizada.....	879	Vara luminosa vermelha.....	770
Rebarbadora elétrica.....	22	Sinalização.....	732	Vassoura dobrável.....	817
Rebarbadora pneumática.....	244	Sinalização acústica.....	632	Verniz.....	644
Rebitadora.....	534	Sinalização auto.....	763	Verniz transparente.....	639
Rebitadora pneumática.....	245	Sinalização materias perigosas.....	733	Viseira malha de arame.....	365
Rebites.....	536	Sincronizador de rega.....	823	Viseiras de proteção.....	358
Recolhedor fita.....	846	Sisal pita de 2 cabos.....	603	Visor latonado.....	842
Rede.....	608	Soda cáustica.....	645	Vitrina magnética.....	775
Redutores de plástico.....	457	Soldador cilíndrico.....	216	Vitrine de cortiça c/ fecho.....	775
Rega gota-a-gota.....	830	Soprador de mochila.....	33	<b>X</b>	
Régua de ligação.....	703	Soprador inverter de mochila.....	45	Xisato.....	127
Régua led.....	710	Sopradora elétrica a bateria.....	13		
Réguas.....	214	Soquete superfície para vários mecanismos.....	699		
Regulador de pressão confort.....	826	Sortido tubos termo retrácteis.....	702		
Relva artificial.....	790	Spray alta pressão.....	40		
Removedor de graffiti.....	630	Spray de limpeza de travões e embraiagens.....	627		
Removedor de manchas.....	631	Spray de limpeza para metais.....	627		
Removedor de pinturas "gel".....	646	Spray de limpeza para para tablier com silicone.....	628		
Reparador de furos.....	629	Spray inox.....	638		
Repelente de água.....	630	Suporte.....	849		
Reposição de vidros de soldagem.....	359	Suporte calçado.....	883		
Revestimento pétreo fachadas.....	647	Suporte de luz giratória.....	769		
Riscador de bolso.....	216	Suporte de parede para mangueira.....	820		
Roda giratória de andaime com travão.....	231	Suporte lâmpadas.....	687		
Rodas.....	223	Suporte para quadro.....	851		
Rodas de carrinho de mão.....	229	Suporte para soldar estanho.....	216		
Rodo metálico industrial.....	222	Suporte plástico e porta viseira.....	365		
Roldana.....	574	Suportes.....	853		
Roldana com parafuso.....	844	<b>T</b>			
Rolo de arame galvanizado.....	608	Tabuleiro de pintura.....	658		



## CONDICIONES GENERALES DE VENTA

### TRANSPORTE – RIESGOS

La mercancía viaja a cuenta y riesgo del comprador, cual sea el modo de expedición; por consiguiente, todo conflicto relativo a este transporte ha de ser solucionado entre el comprador y el transportista.

### DEVOLUCIONES

Una vez recepcionada la mercancía, no se admitirá su devolución. A título excepcional y por causas justificadas se admitirán las devoluciones, canjeándose los productos por otros, siendo los gastos que esta devolución acarree por parte del comprador.

### CLÁUSULA DE RESERVA DE PROPIEDAD

De convenio expreso, conservamos la presente mercancía hasta el pago íntegro de su precio. Talones, efectos y "sumisión de credenciales" sólo serán considerados como pagos a partir del cobro efectivo acerca del comprador.

En caso de no recobrar el precio, el contrato será anulado con pleno derecho desde nuestra solicitud por simple carta certificada dirigida al comprador.

La restitución de mercancías impagadas queda debida por el comprador que falla, a sus gastos y riesgos desde nuestra intimación por carta certificada.

### GARANTÍA

De convenio expreso, nuestra responsabilidad no podrá ser comprometida en el caso en que un estudio técnico se revelaría insuficiente y en el cual apareciera que dicho material es impropio al uso al que el comprador lo destinaba.

La garantía se aplicará para la venta de un material a un cliente con la reserva que éste respete los consejos e instrucciones de uso y mantenimiento del material dados en la documentación adjunta que incorpora el elemento vendido o en su defecto las instrucciones dadas por el personal de Cofan. El plazo de garantía es de 12 meses para todos los materiales nuevos.

Esta garantía sólo concierne estos mismos materiales sin considerar otros perjuicios que podrían ocasionar.

### RECLAMACIONES

De convenio expreso, los Tribunales competentes serán los de nuestra elección para contestar de toda dificultad que pueda nacer de la ejecución o interpretación de los presentes convenios, aunque sea en el caso de pluralidad de demandados (defensores) o de solicitud de garantía.

## CONDITIONS DE VENTE

### TRANSPORTS – RISQUES

Les marchandises voyagent aux risques et périls de l'acheteur quel que soit le mode d'expédition; par conséquent, toute contestation relative à ce transport doit être réglée directement entre l'acheteur et le transporteur.

### RETOUR DE MARCHANDISE

Une fois la marchandise réceptionnée, aucun retour ne sera autorisé. A titre exceptionnel et pour des causes justifiées, nous pourrions autoriser certains retour de marchandise, et le remboursement sera effectué par un échange de produits. Les frais occasionnés par ces retours seront à la charge de l'acheteur.

### CLAUSE DE RESERVE DE PROPRIETE

Il est expressément convenu que nous conservons la propriété des marchandises jusqu'au paiement intégral de leur prix. Les chèques, lettres de change et cession de créances, ne sont considérés comme paiements qu'à la date de leur encaissement effectif auprès de l'acheteur.

En cas de non paiement du prix, le contrat sera annulé de plein droit à notre demande par simple lettre recommandée adressée à l'acheteur.

La restitution des marchandises impayées sera due par l'acheteur défaillant à ses frais et risques sur notre mise en demeure par lettre recommandée.

### GARANTIE

De convention expresse, notre responsabilité ne pourra être engagée dans le cas où une étude technique se révélerait insuffisante et où il apparaîtrait que le-dit matériel est impropre à l'usage auquel l'acheteur le destinait.

La garantie s'appliquera lors de la vente d'un matériel au consommateur sous réserve que celui-ci respecte les conseils et instructions d'emploi et d'entretien du matériel donnés par le vendeur lors de la vente.

Durée de garantie de 12 mois pour tous les matériels réparés et neufs.

Cette garantie concerne uniquement ces mêmes matériels et ne tient pas compte des préjudices qu'ils pourraient occasionner.

### RECLAMATIONS

It is expressly agreed we retain the property of the goods till the entire payment of its price. Cheques, bills, would not be considered as payments till the effective encashment.

In case of insolvency, we would cancel the contract through registered letter. The restitution of non-paid goods is due by the buyer at his own risks and costs upon our formal notice (registered letter).

## CONDITIONS OF SALE

### RISKS OF TRANSPORT

The goods travel at the customer's risks, whatever the way of expedition may be, as a consequence, all contestings are to be resolved between the buyer and the forwarding agent.

### RETURNS

Once the goods are received, their return will not be admitted. As an exceptional matter and righteous causes the returns will be admitted, changing the products by others, the expenses will be taken on behalf of the buyer.

### CLAUSE OF PROPERTY RESERVATION

It is expressly agreed we retain the property of the goods till the entire payment of its price. Cheques, bills, would not be considered as payments till the effective encashment.

In case of insolvency, we would cancel the contract through registered letter. The restitution of non-paid goods is due by the buyer at his own risks and costs upon our formal notice (registered letter).

### WARRANTY

We expressly agree our responsibility would not be committed in case of technical tests on goods would reveal insufficient and where it would appear the material is unfit to the buyer destinate use.

The legal warranty will apply under the reservation the customer has respected the advices, use and maintenance instructions given by the seller in the attached documents incorporated in the products sold or in the instructions given by Cofan staff.

The warranty period is 12 months for all new products. The warranty only concerns these very same products and does not apply to other damages it could cause.

### CONTESTINGS

It is expressly agreed we will choose the competent tribunal in order to answer to eventual difficulties and misinterpretations from the execution of these agreements, even in case of plurality of defendants or callings in warranty.

## CONDIZIONI GENERALI DI VENDITA

### TRASPORTI - RISCHIO

La merce viaggia a carico e rischio del compratore, qualunque sia il mezzo di spedizione; conseguentemente, ogni diatriba relativa al trasporto deve essere risolta fra compratore e trasportatore

### RESI MERCE

"Una volta ricevuta la merce non sarà ammesso alcun reso. A titolo eccezionale e per cause giustificate saranno ammessi resi, in forma di sostituzione con altro prodotto. I costi di tale operazione sono a carico del compratore".

### CLAUSOLA DI RISERVA DI PROPRIETÀ

"E" espressamente convenuto che manteniamo la proprietà della merce fino all'integrale saldo del suo prezzo. Titoli, assegni, cambiali o altri effetti saranno considerati validi ai fini del pagamento solo ad effettivo incasso.

In caso di mancato pagamento, il contratto di vendita si intende annullato con nostro pieno diritto, a nostra semplice richiesta a mezzo raccomandata inviata al compratore.

La restituzione della merce non pagata è a carico del compratore, a suo rischio e pericolo, a seguito di nostra intimazione alla restituzione."

### GARANZIA

"Si conviene che non potrà esserci addebitata alcuna responsabilità nel caso venga verificato un uso improprio del materiale, diverso da quello per il quale lo stesso era destinato.

La garanzia si applica ad ogni contratto di vendita, a condizione che il compratore rispetti i consigli d'uso e le istruzioni di uso e manutenzione riportati da specifico libretto di istruzioni o, in assenza, vengano seguite le istruzioni impartite dal personale Cofan. Il termine di garanzia si intende pari a 12 mesi per ogni particolare nuovo.

La garanzia copre esclusivamente il materiale acquistato ed in nessun caso potrà essere estesa ad eventuali danni conseguenti all'uso del prodotto."

### CONTESTAZIONI

Di comune accordo, si conviene che qualora fosse necessario un arbitrio per cause di garanzia o per la soluzioni di problematiche legate alla esecuzione o all'interpretazione delle presenti indicazioni, il tribunale competente sarà da noi stessi indicato, anche in caso di cause che coinvolgono più ricorrenti

## CONDIÇÕES DE VENDA

### CONDIÇÕES DE VENDA

A mercadoria viaja por conta e risco de o comprador, qualquer que seja o modo de entrega, portanto, qualquer litígio relacionado com esse transporte deve ser resolvido entre o comprador e o transportador.

### DEVOLUÇÕES

Após a recepção das mercadorias, não será admitida a sua devolução. Em circunstâncias excepcionais e com causas justificadas serão admitidas as devoluções, trocando os produtos por outros, sendo os custos que impliquem esta devolução, por parte do comprador

### CLÁUSULA DE RESERVA DE PROPRIEDADE

Fica expressamente acordado que nós manteremos a propriedade da mercadoria até todo o pagamento do seu preço. Cheques, notas, poderão não ser considerados como pagamentos até a cobrança efetiva.

Em caso de insolvência, nós poderemos cancelar o contrato por meio de carta registrada. A restituição da mercadoria não paga é devido pelo o comprador em seus próprios riscos e custos em nossa notificação formal (carta registrada).

### GARANTIA

Concordamos expressamente que a nossa responsabilidade não será comprometida em caso de testes técnicos revelarem-se insuficiente e nos quais aparecer que o material é impróprio para o uso a que o comprador o destinava.

A garantia aplica-se à venda de um material para um cliente com a ressalva de que respeite os conselhos e instruções de uso e manutenção do material dados na documentação anexa que incorpora o item vendido ou as instruções dadas pela equipe Cofan. O prazo da garantia é de 12 meses para todos os novos materiais.

Esta garantia apenas se refere a esses mesmos materiais sem considerar outros danos que possam resultar.

### RECLAMAÇÕES

Por acordo expresso, os tribunais competentes serão da nossa escolha para responder a quaisquer dificuldades que podem surgir a partir da aplicação ou interpretação do destes acordos, mesmo no caso de vários acusados (defesa) ou solicitação de garantia.





**GRUPO COJALI.** Investigación, desarrollo e innovación son los cimientos en los que se asienta Grupo Cojali. Grupo empresarial con más de 29 años de experiencia en el sector industrial y de automoción. Grupo Cojali cuenta con un moderno centro logístico asentado en Campo de Criptana (Ciudad Real). Las instalaciones de más de 80.000 m<sup>2</sup>, están divididas por las distintas actividades y marcas con las que trabaja GRUPO COJALI.

Dentro de este Grupo empresarial nace en 2001 **COFAN** para cubrir las carencias halladas en el sector del Suministro Industrial. Este canal, el comercio de cercanía, puede encontrar en **COFAN** un perfecto aliado, donde además de productos, proporcionamos servicios que ayudan a nuestros distribuidores a crear en nuestro sector y a apostar por él. Aplicando conceptos industriales conseguimos que **COFAN** sea un referente en el mercado en Innovación y creatividad, elaborando estrategias competitivas y compartidas con toda la red de Distribución.

Actualmente tres son los nichos de mercado en los que se ha concentrado **COFAN** durante los últimos años: Ferrería, Bricolaje y Hogar. Cuenta con más de 28.000 referencias, por ello, sus instalaciones cuentan con la última tecnología aplicada a la logística empresarial.

**GRUPE COJALI.** Recherche, développement et innovation sont les piliers sur lesquels le Groupe Cojali s'appuie. Avec ses 29 années d'expérience dans le secteur automobile et industriel, le Groupe Cojali dispose d'un centre logistique moderne situé à Campo de Criptana (Ciudad Real). Les installations de plus de 80.000 m<sup>2</sup>, sont divisées en différentes activités et marques avec lesquelles travaille le GROUPE COJALI.

Dans ce Groupe industriel fondé en 2001, **COFAN** couvre les besoins du secteur de la fourniture industrielle. Notre canal, le commerce de proximité, trouve en **COFAN** un partenaire parfait, qui fournit, outre ses produits de qualité, des services qui aident nos distributeurs à croire dans notre secteur d'activité et à s'y consacrer. Grâce à ses concepts industriels, **COFAN** est un fournisseur de référence sur un marché en terme d'Innovation et de créativité, dans l'élaboration de stratégies compétitives et partagées avec tout le réseau de Distribution.

Au cours des trois dernières années, **COFAN** s'est concentré sur trois niches essentielles, la Quincaillerie, le Bricolage et l'Équipement de la et compte plus de 28.000 références. C'est pour cette raison que ses locaux disposent de la dernière technologie en matière de logistique.

**COJALI GROUP.** Research, development and innovation are the foundations upon which Cojali is built. Our business group has more than 29 years experience in industrial and automotive sector. Cojali Group has a modern logistics centre located in Campo de Criptana (Ciudad Real). Its facilities, with more than 80,000 m<sup>2</sup>, are divided by the different activities and brands COJALI GROUP works with.

**COFAN** was born in 2001 to cover all the needs found in the industrial supply sector. Our channel, the proximity commerce, can find in **COFAN** a perfect ally as we provide not only products but also services that help our distributors believe in our sector and be committed to it. **COFAN** is leader in the market, in innovation and creativity by applying industrial concepts and creating competitive strategies which are shared with all the distribution network.

Nowadays, **COFAN** is focused on three niche markets: Hardware, DIY and Home. With more than 28,000 references, its facilities are equipped with the latest technology applied to business logistics.

**GRUPPO COJALI.** Ricerca, Sviluppo e Innovazione sono le fondamenta sulle quali poggia il Gruppo Cojali. Azienda con più di 29 anni di esperienza nel settore industriale e dello automotive. Il Gruppo Cojali dispone di un moderno centro logistico situato a Campo de Criptana (Ciudad Real). La fabbrica, con un'estensione di più di 80.000 m<sup>2</sup>, è suddivisa in distinte attività e marchi.

All'interno del Gruppo COJALI nasce nel 2001 **COFAN**, per coprire le carenze riscontrate nel settore delle forniture industriali. Il commercio locale può trovare in **COFAN** un alleato perfetto, dove oltre ai prodotti, vengono forniti servizi che aiutano i nostri distributori a scommettere attivamente nel nostro settore. Applicando concetti industriali, **COFAN** diventa un punto di riferimento nel mercato dell'innovazione e della creatività, sviluppando strategie competitive e condividendole con l'intera rete di distribuzione.

Attualmente ci sono tre categorie di prodotti sulle quali si è concentrata **COFAN** negli ultimi anni: Ferramenta, Bricolage e Prodotti per la Casa. L'azienda dispone di più di 28.000 particolari, per questo motivo, all'interno della propria struttura, utilizza le ultime novità tecnologiche applicate alla logistica d'impresa.

**GRUPO COJALI.** Investigação, desenvolvimento e inovação são as bases onde assenta o Grupo Cojali. Grupo empresarial com mais de 29 anos de experiência no setor industrial e automotivo. O Cojali Group tem um centro logístico moderno situado em Campo de Criptana (Ciudad Real). As instalações de mais de 80.000 m<sup>2</sup>, estão divididas pelas diferentes atividades e marcas com as que trabalha o GRUPO COJALI.

Dentro deste grupo empresarial nasce em 2001 **COFAN** para cobrir as necessidades encontradas no setor de Abastecimento Industrial. Nosso canal, o comércio local e mais próximo, pode encontrar em **COFAN** um aliado perfeito, onde além dos produtos, também fornecemos serviços que ajudam os nossos distribuidores a acreditar no nosso setor e a apostar por ele. Aplicando conceitos industriais conseguimos que **COFAN** seja uma referência no mercado em Inovação e criatividade, desenvolvendo estratégias competitivas e compartilhado com toda a Rede de distribuição.

Atualmente existem três áreas do mercado em que se concentrou **COFAN** nos últimos anos: Ferragens, Bricolage e Casa. Conta com mais de 28.000 referências, por isso, as suas instalações têm a mais recente tecnologia aplicada à logística empresarial.





[www.cofan.es](http://www.cofan.es)

VENTA EXCLUSIVA MAYORISTAS  
VENTE EXCLUSIVEMENT AUX GROSSISTES  
EXCLUSIVE SALE TO WHOLESALEERS  
VENDITA ESCLUSIVA GROSSISTI  
VENDA EXCLUSIVA GROSSISTAS

**COFAN, S.A.**

Avenida de la Industria, S.N.

13610 Campo de Criptana / Ciudad Real / España

Tel.: +34 926 56 39 28 / Fax.: +34 926 56 39 29

Email: [cofan@cofansa.com](mailto:cofan@cofansa.com) / [www.cofan.es](http://www.cofan.es)

**DISTRIBUIDOR / DISTRIBUTOR:**

